

81.2085

235

THIRTY-FOURTH EDITION.

FROM FILE 20 NOV 1884  
626 E. CAPITOL, WASH.  
15 Nov 84

# Priced and Illustrated Catalogue OF PHYSICAL INSTRUMENTS.

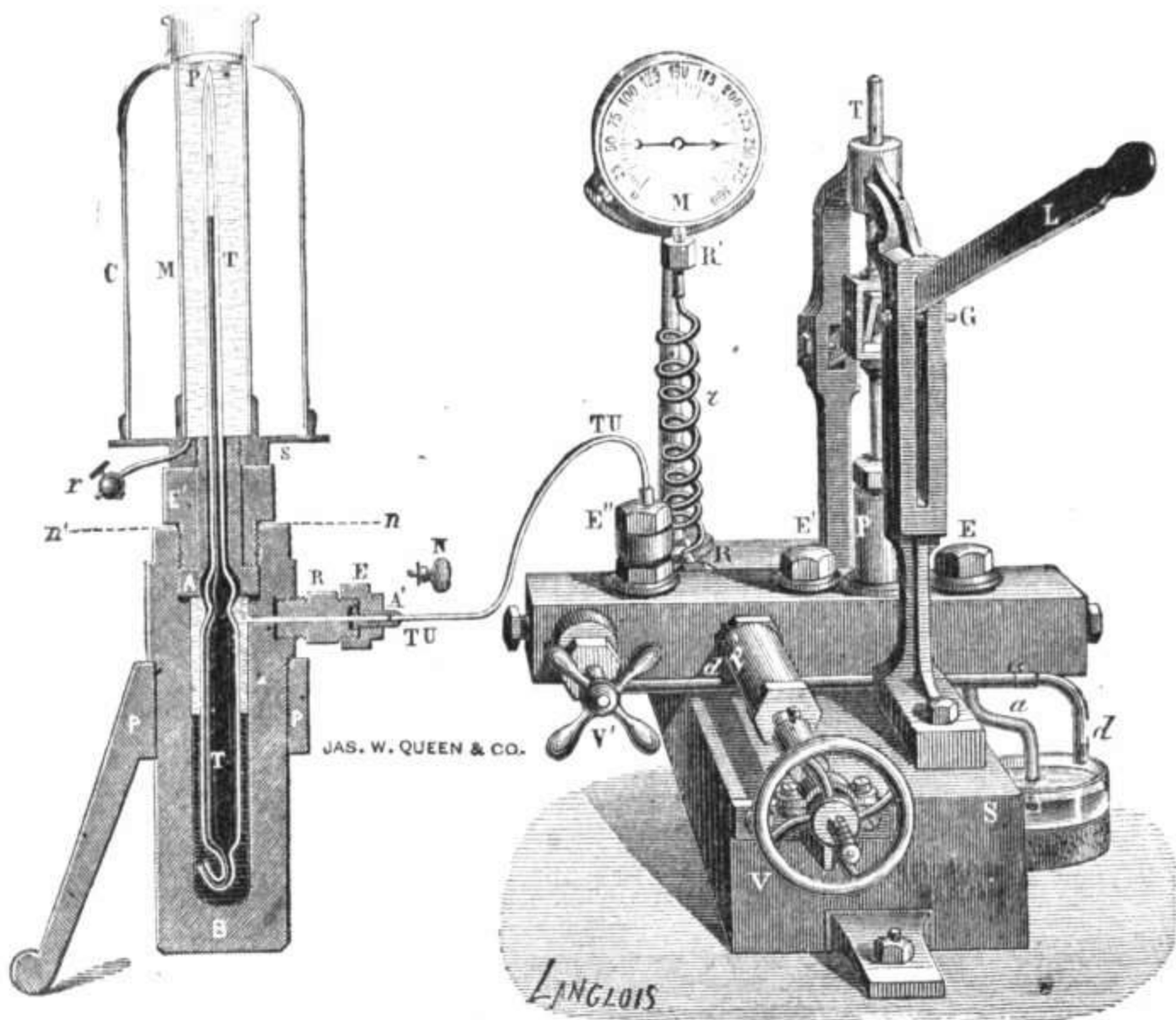

CAILLETET'S APPARATUS FOR THE LIQUEFACTION OF GAS.

## CHEMICALS AND CHEMICAL APPARATUS.

MADE, IMPORTED AND SOLD, WHOLESALE AND RETAIL,

BY

JAMES W. QUEEN & Co.,

No. 924 CHESTNUT STREET, PHILADELPHIA.

1884.

52536  
Entered according to Act of Congress, in the year 1880, by JAMES W. QUEEN & Co., in the Office of the Librarian of Congress, Washington.

---

## NOTICE.

---

Having the largest and best assorted Stock of Mathematical, Optical, and Philosophical Instruments, both of foreign and domestic manufacture, in the United States, we are enabled to offer unequalled facilities and inducements to intending purchasers.

In ordering Instruments and materials from this Catalogue, it is merely necessary to state the edition and the numbers of the articles. *All former editions are superseded by this one.*

All Instruments and materials sold by us are warranted perfect for the purposes intended; and if not found so upon receipt, should be returned and exchanged for others.

### TERMS CASH.

The prices throughout the Catalogue will be strictly adhered to.

When no satisfactory Philadelphia or New York reference is given by the party ordering the goods, the money should accompany the order; but where it does not, (either from want of confidence or other cause,) the goods will be forwarded by express, with bill, C. O. D. (collect on delivery), *provided a remittance equal to one-third the total amount of the order is sent with it.*

*No order for a less amount than Five Dollars will be sent C. O. D.*

The Express Company's charge for collecting and returning the money on C. O. D. bills must be paid by the party ordering the goods.

The safest and most economical method of remitting money is by Bank Draft or Post-Office Order, made payable to us. Where neither of these can be procured, United States or National Bank Notes, or Postage Stamps, can be sent by express with safety, the sender prepaying the express charges.

*Goods ordered to be sent by mail must be prepaid, and the return postage or freight included in the remittance.*

Packing-boxes will be charged for at reasonable prices, and all goods will be packed with the utmost care; *but no responsibility will be assumed by us, for breakage or other damage, after a package leaves our premises, except upon special contract.*

### IMPORTING INSTRUMENTS FREE OF DUTY.

By authority of Act of Congress, June 22, 1874, all Colleges, Schools, Literary, Scientific, or Religious Societies of the United States, are permitted to import, free of duty, Books, Charts, Engravings, and Instruments to be used in connection with the educational exercises of the institution for which they are ordered.

We shall be pleased to receive orders for instruments to be imported under this Act, and on application we will give estimates and instructions for proposed orders to be thus imported from any foreign country. The present duty on books and engravings is twenty-five per cent *ad valorem*, and on instruments forty per cent.

JAMES W. QUEEN & CO.

PHILADELPHIA, 1884.

PRICED AND ILLUSTRATED

CATALOGUE

OF

PHYSICAL INSTRUMENTS

CHEMICAL APPARATUS, CHEMICALS

AND

SCHOOL APPARATUS GENERALLY,

MADE, IMPORTED AND SOLD, WHOLESALE AND RETAIL, BY

*Queen, James W., & Co., Philadelphia*

JAMES W. QUEEN & Co.,

Nos. 924 CHESTNUT STREET,

AND

925 SANSOM STREET,

PHILADELPHIA.

Please let friends interested in Science see this Catalogue

---

## NOTICE

---

THE optical instrument business, of which this catalogue is an exponent, was established twenty-four years ago by Mr. James W. Queen, of this city, who had been previously connected for more than a quarter of a century with the oldest optical firm in the United States.

Though small and unpretending as his store and business were at the outset, Mr. Queen's thorough knowledge of the business, together with a full appreciation of the wants of those engaged in scientific research, soon convinced the community that his was an institution of great value; and from this small beginning rapidly grew the largest and most comprehensive establishment of the kind, not only in the United States, but in the world.

The character and uses of scientific instruments are so varied and the stock so large as to require, in our establishment, their division into special departments, each of which is under the oversight of a person competent, both by his knowledge and business ability, to keep the instruments of his department up to the highest standard.

Our spectacle department has its competent manager and corps of assistants; and the reputation the house now enjoys is a national one for perfection of its spectacles and eye-glasses, and precision of adaptation to the form of the face and defects of the sight.

Our microscope department will be found, by those desiring microscopes and accessory articles, to be more complete than any other establishment in the United States, both in character and variety of our stock and the ability of its management.

Our optical catalogue contains a very exhaustive list of spectacles, eye-glasses, lenses, apparatus for illustrating the laws and principles of optics, polariscopes, telescopes, field-glasses, microscopes, etc. 188 pages.

Our mathematical instrument department also has its separate management and corps of assistants. The catalogue of 162 pages, representing that branch, is quite a complete manual of the instruments and their use.

Our magic lantern department comprises every form of magic lantern, from the most insignificant toy to the most complete scientific instrument, with accessories for lecture illustrations. The catalogue of 150 pages, besides describing the various instruments, contains a full list of photographic transparencies and colored pictures of scenery, statuary, celebrated paintings and engravings, scientific illustrations and diagrams.

Our philosophical department comprises all instruments designed for demonstrating the laws, principles and facts of physical science. The catalogue of 190 pages, contains an elaborate list of apparatus.

It is our intention to make and sell none but perfect instruments in each of the departments of our business, and to supply to our customers the article or articles ordered or that will be best suited for the purposes wished to be accomplished.

JAMES W. QUEEN & CO.



1-2753  
935  
1919-20

## PREFACE TO THE TWENTY-EIGHTH EDITION.

---

We extend a cordial invitation to all *Professors of Physical and Chemical Science, Teachers and Scientific* persons to visit our establishment during their *summer vacation*, or *whenever* passing through *Philadelphia*. We have *in stock* the largest collection of any house in America of really fine apparatus, of the *latest* and most approved designs. We shall be prepared to allow a close inspection of our varied stock; and shall be glad to show the *Celebrated Crookes' Radiant Matter Tubes, Cailletet's Apparatus*, etc., etc., in *operation*.

We have ample facilities for the manufacture of special *Scientific Apparatus*, for *original investigation*. Our large stock enables us to furnish goods promptly in most cases.

See the *Recommendations* of the *eminent Scientists*.

We wish to enlist the support of *Scientists and Teachers* in our "endeavor to furnish high-grade apparatus at a reasonable price." We are enlarging our stock, also our manufacturing facilities.

To those institutions which desire to import any special apparatus, Chemical or Physical, we would call attention to our *very low rates of importation*. Our special facilities and large importations enable us to import apparatus cheaper than a college can. We import at the catalogue prices of foreign manufacturers, and give our customers the benefit of the careful packing, prompt attention, etc., which we enjoy through our various *European Agents*. We can refer to many of our large institutions who now regularly give us their orders in this way.

JAMES W. QUEEN & CO., PHILADELPHIA.

COLUMBIAN UNIVERSITY, *Washington, D. C., Feb. 24th, 1881.*

I take pleasure in stating that for the several institutions in which I lecture on Chemistry and Physics, I have for seven or eight years procured apparatus solely from JAS. W. QUEEN & CO., of Philadelphia. I have used several of their Air-pumps, with all their accessories, also various kinds of electrical apparatus, such as Plate Machines, Induction Coils, Batteries of all kinds, Plunge and otherwise, and all apparatus used in Dynamic Electricity. I have used their Lanterns with Oxy-Hydrogen Lamps with the usual accompanying apparatus for experiments with spectroscopes, etc., etc. In fact, for general physical projection, I have found their glass and metal apparatus, used in illustrating Chemistry and Physics, in all cases of the first quality, and just what they claim for them. I therefore most heartily recommend the old-established house, to all persons wishing to procure good apparatus.

Most respectfully,

E. T. FRISTOE, *Prof. of Chemistry and Physics.*

ROCHESTER, MINN., *4th mo. 20th, 1881.*

JAMES W. QUEEN & CO.—*Gentlemen:*—At six or eight different times, I have ordered goods of you, both while at La Crosse, Wisconsin, and here; they have always been more than satisfactory; the goods have always been of excellent quality, quite up to representation. The Air-Pump, with accessory apparatus, ordered not long since, proved of more *practical value* than one purchased several years ago at more than twice the cost.

Yours truly,

H. O. DURKEE, *Office Supt. Public Schools.*

The manager of our Philosophical and Chemical department, has recently returned from an extensive tour of Europe, and we take this means of announcing that we have now on hand a large and varied stock of fine Chemical and Physical Apparatus, which we sell at moderate prices, and further, that we have made special arrangements for the manufacture and sale of several new forms of apparatus, illustrating the latest scientific discoveries, prominent among which are the celebrated "Radiant Matter Tubes," of Professor Crookes, which illustrate his marvelous discoveries so beautifully. (Send for his lecture, as delivered before the British Association for the Advancement of Science. Price, 25 cents). We have on hand a fine collection of *Royal Berlin, Meissen* and German Porcelain Ware, French, German and Bohemian Glass Apparatus, Agate Mortars, Beaufay Crucibles, Hessian Crucibles, *New Wood and Iron Chemical supports*, Filtering Paper of all kinds *Analytical Balances*, very low prices. We also furnish Pure Chemicals, Choice Reagents, C. P. Acids and Salts. *Platinum Ware* of all kinds, Crucibles, Capsules, Tongs, Foil Wire, etc., etc.

We have just received the wonderful *Aladdin's Lamp*, made with Balmaine's Patent *Luminous Paint*, *Charts of the Diffraction Spectrum*, very fine. We have the largest stock of *Geissler Tubes* in America, from 6 in. to 60 in., exquisitely beautiful in design. *New Spectroscope* for students' use, very cheap; *Ruhmkorff Coils*, improved construction, great variety in stock. *New Dipping Battery*, very popular; *Spectrum Tubes* in great variety at reduced prices; *New and Improved Polaroscope*, with a fine collection of sections of crystals, *Calc Spar Rhombs*, beautifully polished, and cut perpendicular to the axis. *Cailletet's apparatus* for the liquefaction of gases, *New and Improved Holtz Machines*, *Edison's Phonograph*, \$10. We are constantly receiving additions.

Having the largest and best assorted stock of scientific apparatus, both of foreign and domestic manufacture, in the United States, comprising a varied and extensive collection of Mathematical, Optical, Philosophical and Chemical Apparatus, and Chemicals, we are enabled to offer unequalled facilities and inducements to intending purchasers.

We furnish Fletcher's Gas Furnaces and accessory apparatus. We are *Sole Agents* in *Philadelphia* for Judson's New Sectional Assay Furnaces, and can supply Assaying Apparatus of all kinds.

We keep in stock, and import to order, Standard Resistance Coils, etc., etc., from Elliott and other makers. Browning's Spectroscopes, Auzoux's Anatomical Models, Koenig's Acoustic Apparatus, etc., etc.

# CATALOGUE OF PHYSICAL INSTRUMENTS.

## CHAPTER I

### INSTRUMENTS ILLUSTRATING THE ESSENTIAL RELATIONS OF MATTER AND FORCE.

#### SECTION I.—ON MEASUREMENT.



4004.

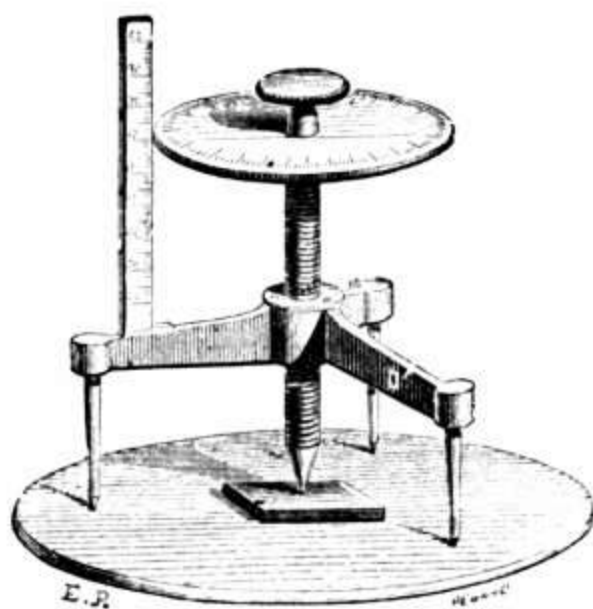

4005 4005½

No.		PRICE.
4000.	<b>Metre and Yard.</b> Rod of wood with metal tips, having the metre and the yard with their subdivisions on adjacent sides.....	\$1 75
4001.	<b>Steel Tape.</b> Six feet in length, divided on one side into feet and inches, on the other into millimetres.....	3 00
4002.	<b>Card-Board Rule.</b> Half a metre in length, accurately divided to millimetres on one edge, and inches and subdivisions on the other.	1 00
4003.	<b>Model of Vernier.</b> Straight form, of white-wood, one metre in length.....	6 00
4004.	<b>Model of Vernier.</b> Of white-wood, arc of circle, one metre in diameter.....	8 00
4005.	<b>Spherometer,</b> with $\frac{1}{2}$ millimetre, micrometer screw, reading to $\frac{1}{1000}$ of a millimetre. The triangle formed by the three feet inscribes a circle of five centimetres diameter..... D. F.	22 50
4005½.	<b>Spherometer,</b> same as No. 4005, but with a circle ten centimetres in diameter..... D. F.	27 50
	Larger and finer Spherometers made to order.	
4006.	<b>Cathetometer.</b> To measure small differences of level in liquids, at a distance from the observed column. German form.....	
4008.	<b>Leroy's Dynamometer, or Spring Balance.</b> 12 inches long, for measurement of weights up to twenty-five pounds.....	5 00
4009.	<b>Spring Balance,</b> with dial. For measurement of weights up to twenty pounds.....	10 00
4010.	<b>Regnier's Dynamometer.</b> For measurement of powerful forces or weights.....	60 00
4020.	<b>Metric Chart,</b> cloth varnished, mounted upon roller, and finished in colors.....	1 00
4021.	<b>Metre,</b> fourfold, with hinges.....	1 00



4008.



4009.

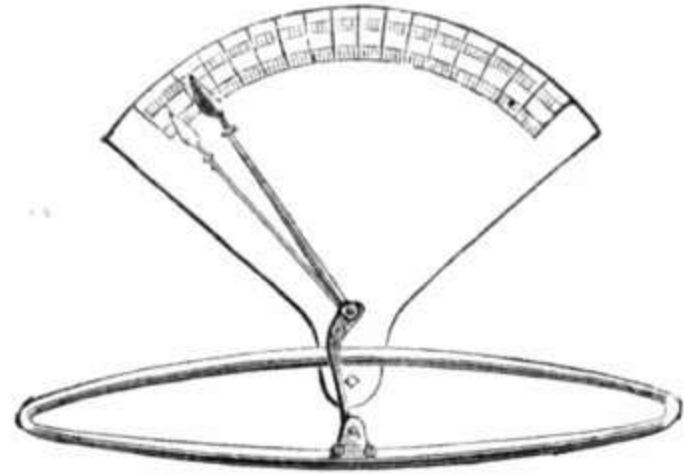

4010.

	PRICE
4022. <b>School Metre</b> , four faces, showing metre, decimetre, centimetre and millimetre.....	60
4023. <b>Litre Block</b> . Dissected and graduated litre block, of polished mahogany, one decimetre cube, weight one kilogramme, separable into one gramme, ten grammes, one hundred, or in litre, decilitre, centilitre and millilitre blocks, graduated in millimetres, each piece adjusted to specific gravity of water.....	\$2 50
4024. <b>Litre Case of Copper</b> , graduated.....	2 00 & 3 00
4025. <b>Double Litre to Centilitre</b> , of polished copper, eight pieces.....	2 40
4026. <b>Decalitre to Decilitre</b> . Market form, of wood, seven pieces.....	1 50
4027. <b>Brass Weights</b> , kilogramme to gramme, thirteen pieces.....	4 50
4028. <b>Fairbanks' Balance</b> , capacity, gramme to two kilogrammes.....	4 50
4028½. <b>School Scales</b> , sensitive to two grammes, and weighing two kilogrammes.....	1 60

We are prepared to furnish the various Metric Weights and Measures, as supplied by the Trustees of the American Metric Bureau.

SECTION II.—MOLECULAR FORCES.



4015.

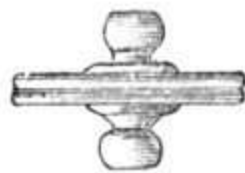

4030.

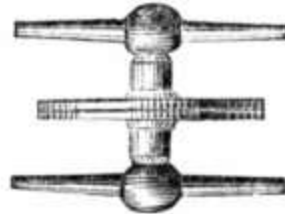

4031.



4032.



4033.

4029. <b>Prince Rupert's Drops</b> . Per Dozen.....	40
4030. <b>Pair of Cohesion Plates</b> . Of Glass, three inches in diameter.....	75
4031. <b>Pair of Cohesion Plates</b> . Of brass, three inches in diameter.....	5 00
4032. <b>Pair of Cohesion Hemispheres</b> . Of lead, one and a quarter inches in diameter.....	75
4033. <b>Adhesion Disc</b> . Of glass, three inches in diameter, supported by a silk cord at the centre.....	75

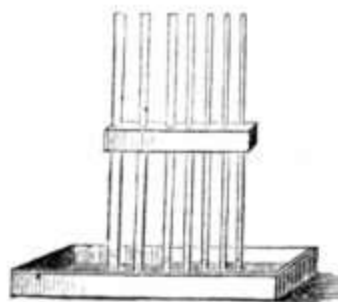

4034.

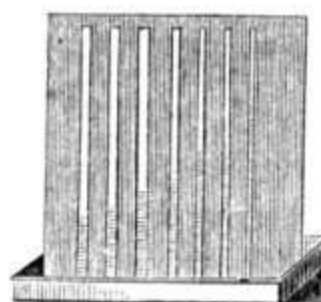

4035.

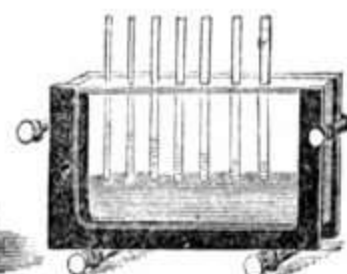

4036.



	PRICE
4034. <b>Capillary Tubes.</b> Set of six, in wooden frame, with tin water-pan..	\$1 25
4035. <b>Capillary Tubes.</b> Set of six, mounted on a tin frame, with water-pan attached .....	2 00
4036. <b>Capillary Tubes.</b> Set of six, mounted in a glass cell, with brass clamps, for the projection of the phenomenon upon a screen.....	4 00
4037. <b>Capillary Plates.</b> A pair, four inches square, of thick, polished plate-glass, with brass clamps and a Water-cell.....	3 00
4038. <b>Capillary Plates.</b> A pair, four inches square, of thick, polished plate-glass, with brass clamps and metal pan, arranged for projection...	4 00

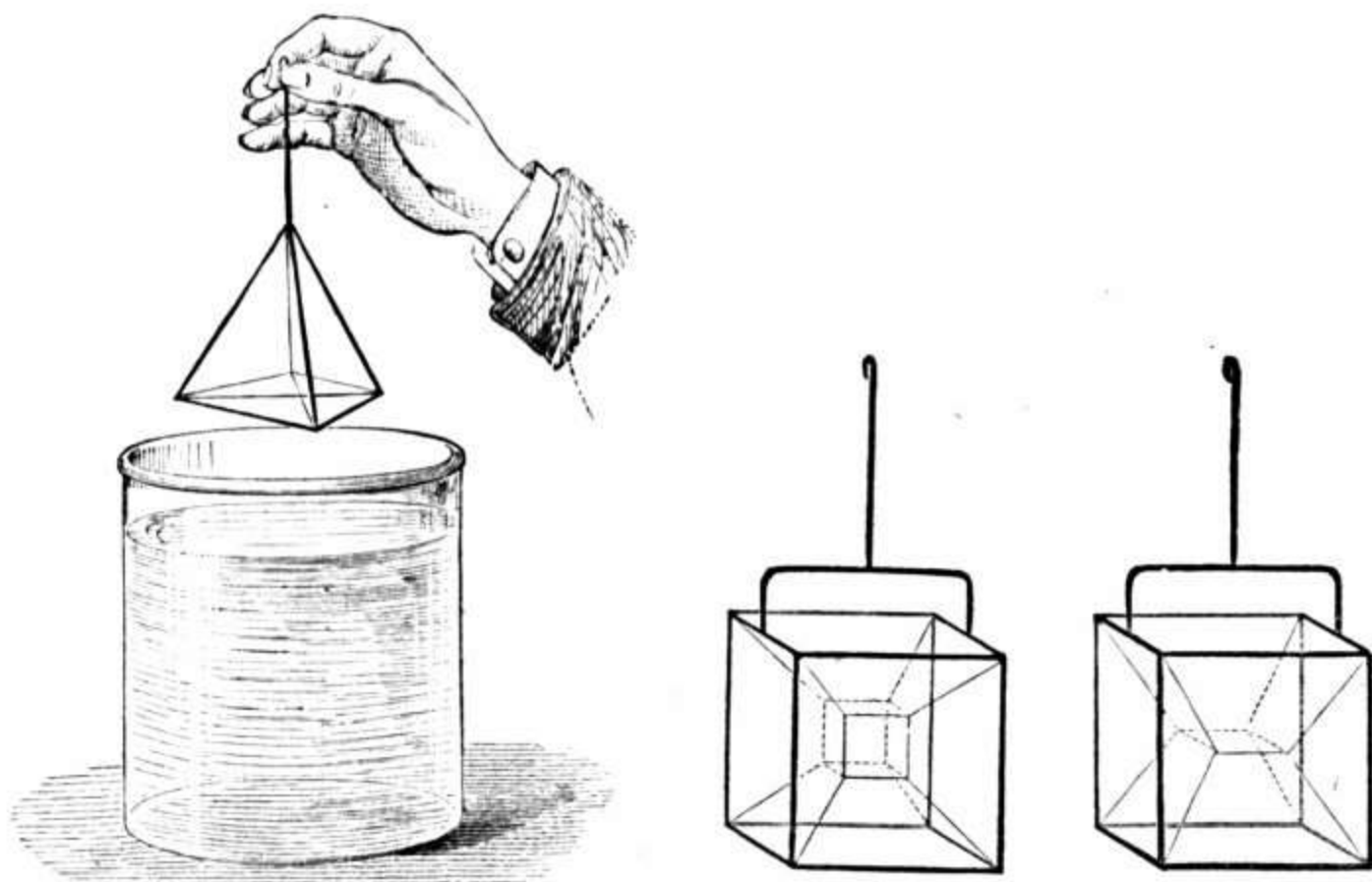

4039.

4039. <b>Cohesion Figures.</b> A series of wire forms, or skeletons, representing the tetrahedron, cube, globe, cylinder, square pyramid, and hexagon, with supports; and a gallon vessel of glass, to be filled with Platteau's mixture of glycerine .....	4 00
4040. <b>Geometrical Forms.</b> Oblate spheroid, prolate spheroid, sphere, hemisphere, triangular prism, hexagonal prism, cylinder, pyramid and frustum, cone and frustum, cubes, parallelopiped, &c., made of white-wood, and neatly finished.....	5 00
4041. <b>Geometrical Forms.</b> Similar to No. 4040, but larger, and made of pear-wood.....	12 50
4042. <b>Models of Crystals.</b> Set of twenty-five forms, of glass, contained in a neat box, about 13 inches by 9, with velvet fitting. The separate pieces vary from one and a quarter inches square, for the cube, to two and a half inches long, for the hexagonal prism; and form altogether the neatest and best set yet devised. The forms are as follows: 1, cube; 2, octahedron; 3, tetrahedron; 4, dodecahedron; 5, pentagonal dodecahedron; 6, trapezohedron; 7 and 8, cube with truncated corners; 9, cube with truncated edges; 10, right-square prism with truncated corners; 11, right-square prism with truncated edges; 12 and 13, square octahedra; 14, rhombic octahedron; 15 and 16, truncated rhombic prisms; 17, rhomboidal prism; 18, obtuse rhombohedron; 19, acute rhombohedron; 20, hexagonal prism; 21, 22, 23, truncated hexagonal prisms; 24, double hexagonal pyramid; and 25, scalene dodecahedron.....	20 00
4043. <b>Dissected Cube,</b> for illustrating the Trinomial Theorem.....	2 00
4044. <b>Dissected Cone.</b> Illustrating conic sections, viz., the circle, ellipse, parabola and hyperbola.....	3 00

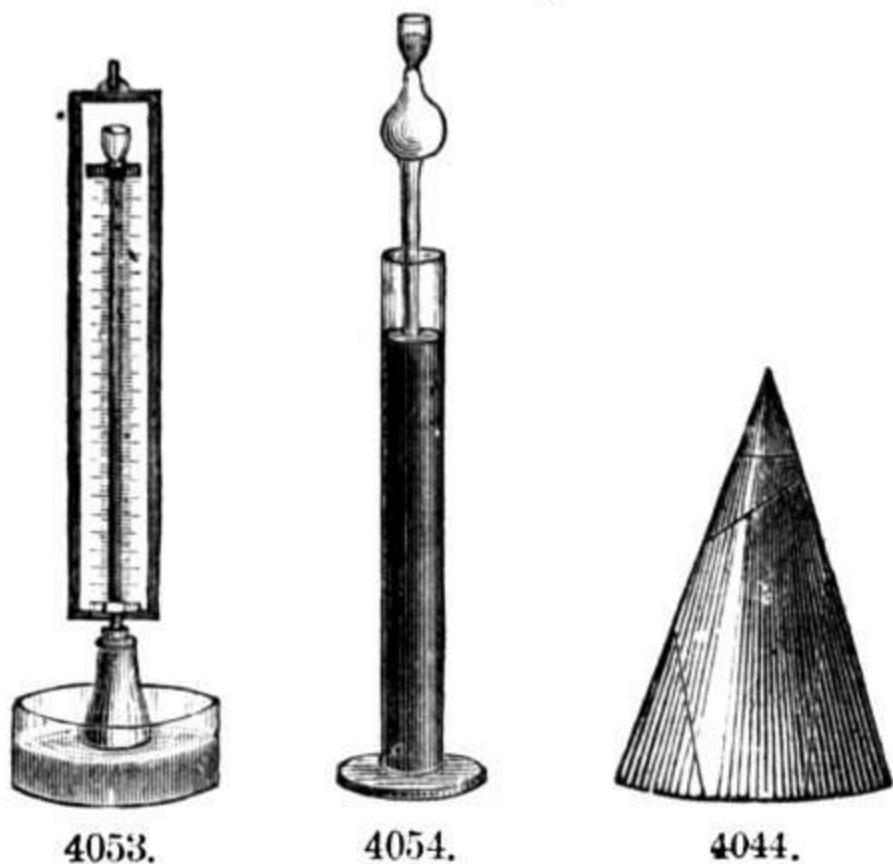

- |  | PRICE  |
|--|--------|
| 4053. <b>Dutochet's Endosmeter.</b> Consisting of an inverted glass bell, closed at the bottom by a porous membrane, and at the top by a cork carrying a glass tube, with scale. The whole instrument is suspended so that the bell dips into a tank containing that fluid of the two to be experimented upon whose penetrating power is greatest, while the other is poured into the bell and tube..... | \$4 50 |
| 4054. <b>Graham's Diffusimeter.</b> Consisting of a vase for mercury, a glass tube with a ball, and narrow neck, closed by a plug of plaster of Paris..  | 3 00   |
| 4056. <b>Oersted's Apparatus</b> for compression of fluids. Consisting of a strong glass cylinder, sixteen inches high by two and three quarters in diameter, with heavy metal base, and cap as shown in the cut. (See p. 5.) A tube with recurved neck, and a metal scale enclosed in the main tube, serve for the registering apparatus..... D. F.   | 22 50  |

SECTION III.—ON IMPACT.

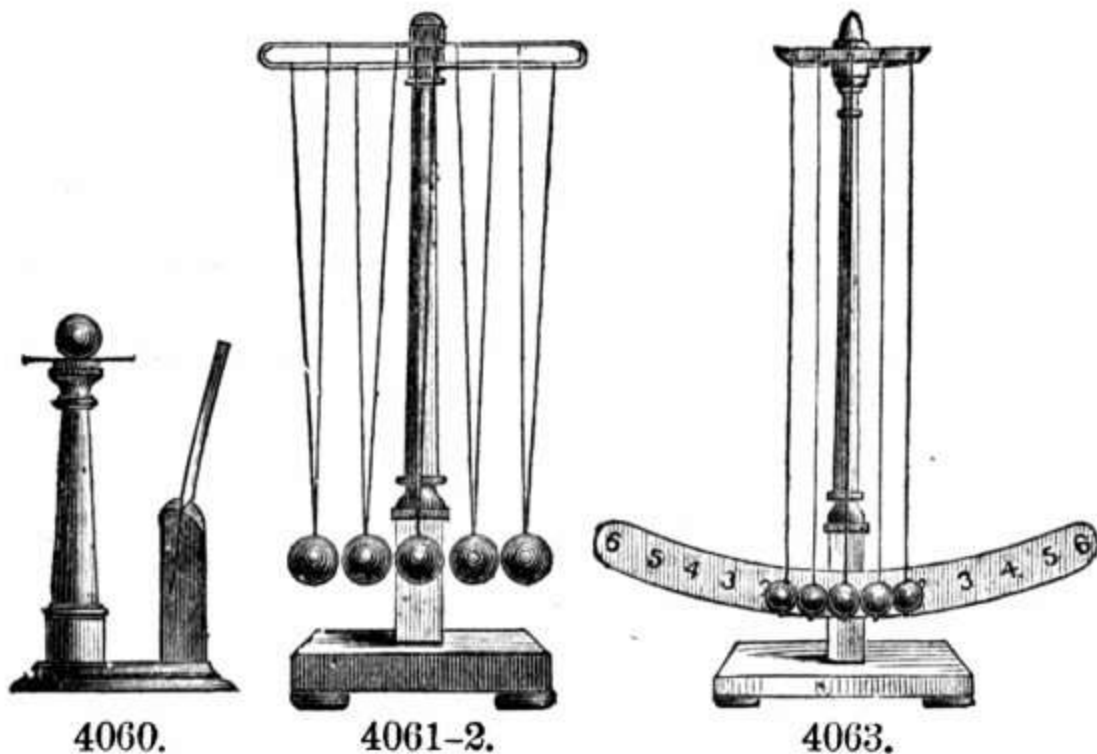

- |  |      |
|--|------|
| 4060. <b>Inertia Apparatus.</b> Mahogany stand, with spring, card and ball.... | 1 00 |
|--|------|

- |   | PRICE  |
|---|--------|
| 4061. <b>Collision Balls.</b> Set of five highly elastic balls, one and a half inches in diameter, mounted with double cords on a mahogany frame, thirty inches high.....   | \$4 50 |
| 4062. <b>Collision Balls.</b> Set of five ivory balls, one and a quarter inches in diameter, mounted with double cords on a mahogany frame, thirty inches high.....   | 10 00  |
| 4063. <b>Collision Balls.</b> Set of five imitation ivory balls of the highest attainable elasticity, two and a half inches in diameter, and accurately spherical, mounted with double cords on a strong mahogany frame, three and a half feet high, with graduated arc.. | 30 00  |

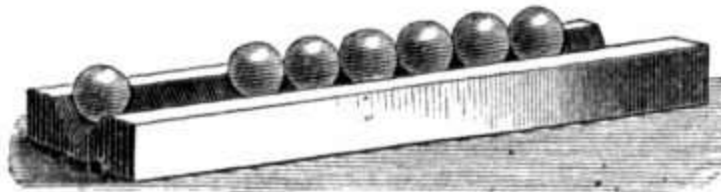

4064.

- |  |      |
|--|------|
| 4064. <b>Collision Balls.</b> Set of seven glass balls, one and a half inches in diameter, with a groove in a mahogany base, one metre in length.. | 5 00 |
| 4065. <b>Collision Plate.</b> A slab of marble, one foot square, in wooden frame, and a ball of ivory.....   | 4 00 |

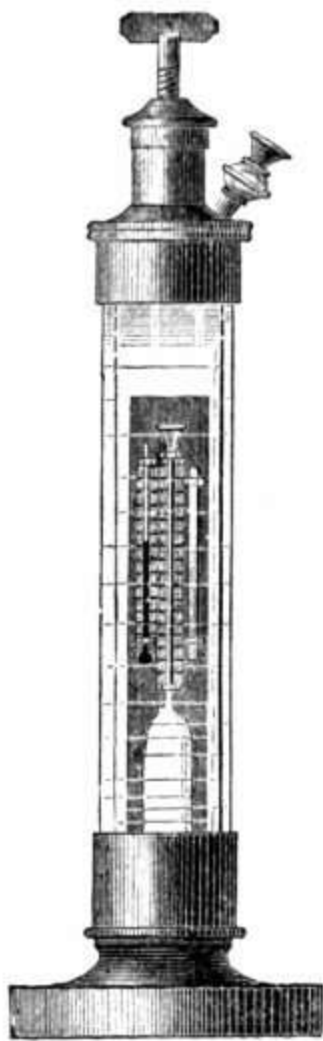

4056.

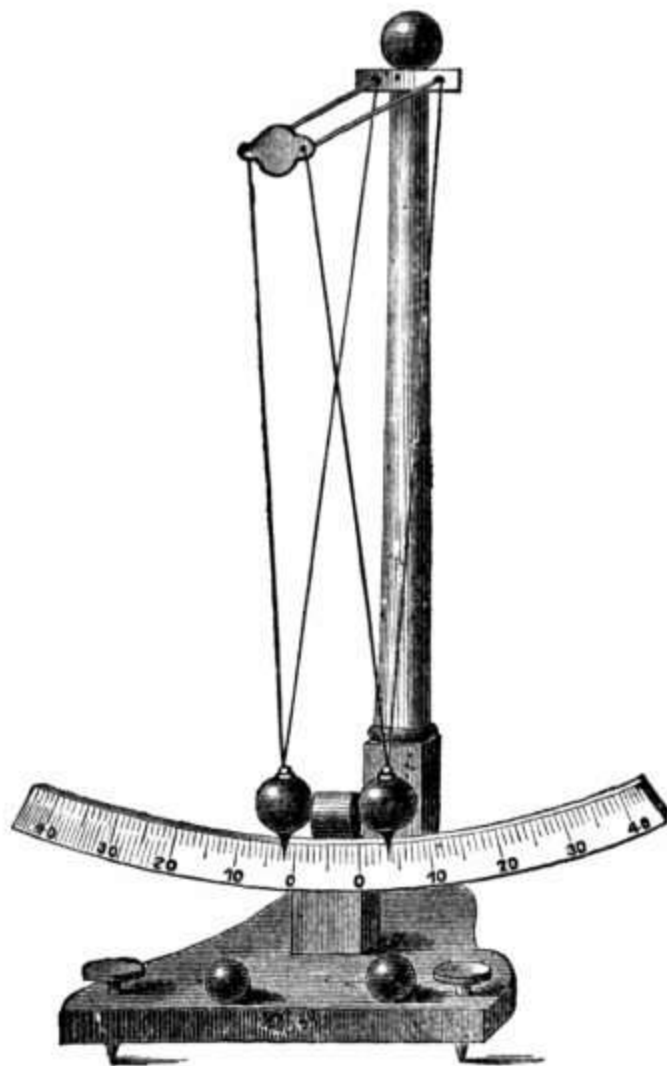

4066.

4066. **Complete Apparatus** for the demonstration of the laws of impact, both in elastic and non-elastic bodies. Consists of a post of mahogany, three feet and a half high, with graduated arc; on a firm base of the same material, supporting by double cords of silk the following:
- 1st. Two elastic balls, of precisely equal masses.

- 2d. One elastic ball, of exactly half the mass of each of the former.  
 2d. One elastic ball, of exactly one quarter the mass of the same.  
 4th. Two non-elastic balls, of exactly equal masses.  
 5th. One non-elastic ball, of exactly half the mass of each of the former.  
 A spring pistol is so adjusted on the base between the balls, as to strike both at the same instant with equal force. It can be removed entirely when necessary.....

\$40 00

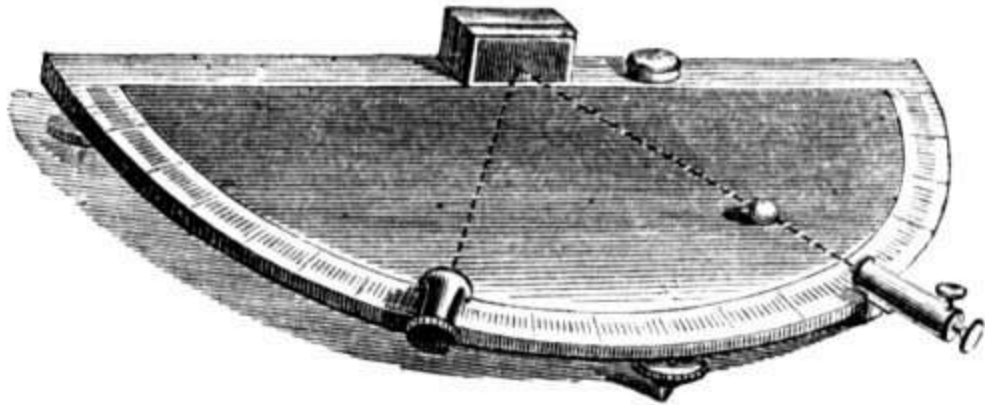

4069.

4069. **Apparatus to Illustrate the Reflexion of Motion.** Consisting of a semicircular table of cherry, a marble slab for reflector, a spring pistol, ivory ball, and pocket to catch the ball after the rebound. Edge of table graduated to show the relation between angles of incidence and reflexion.....

20 00

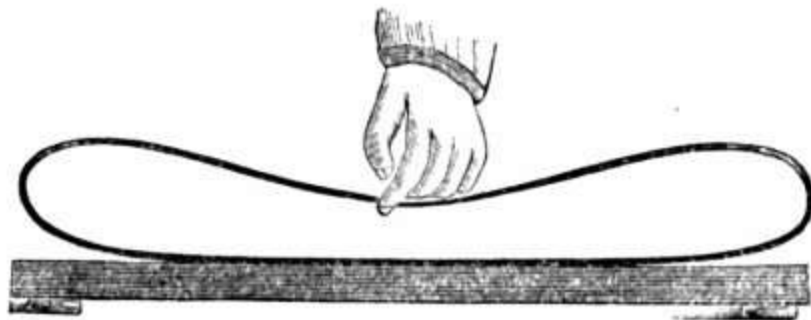

4070.

4070. **Hoop of Brass,** to illustrate the alternate expansion and contraction of an elastic body, when compressed and then set free. On base of polished mahogany.....

3 00

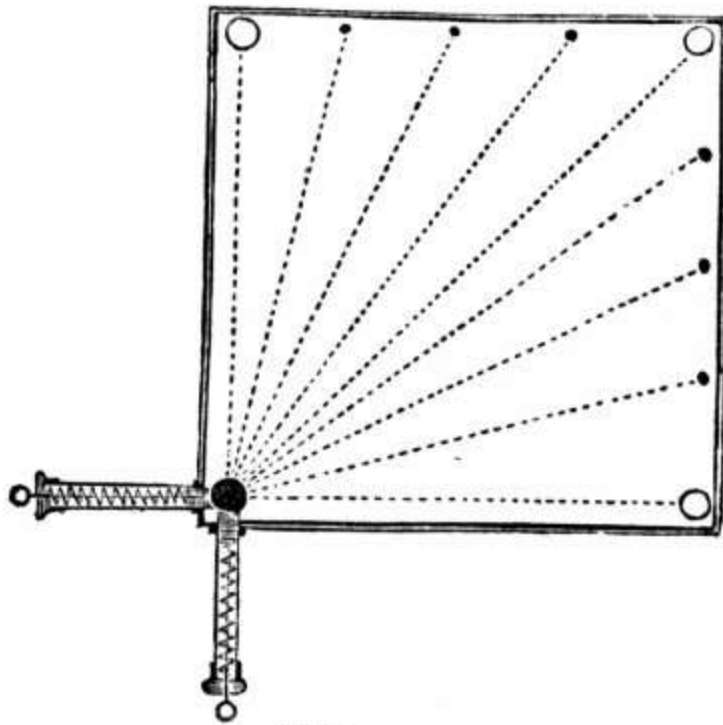

4071.

INSTRUMENTS ILLUSTRATING ROTARY OR TANGENTIAL FORCES.

7

	PRICE
4071. <b>Resultant Table.</b> A table of mahogany, eighteen inches square, with spring pistols and ball.....	\$10 00
4072. <b>Resultant Table.</b> Same as preceding, but with an arrangement for drawing the pistols with any proportionate force, and for discharging them simultaneously .....	30 00

SECTION IV.

INSTRUMENTS ILLUSTRATING ROTARY OR TANGENTIAL FORCES.

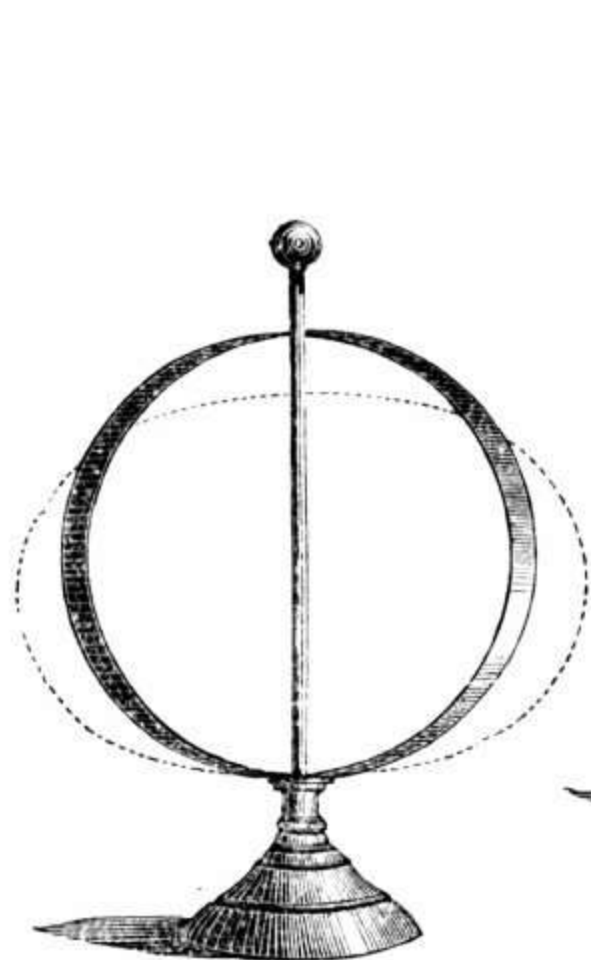

4075.

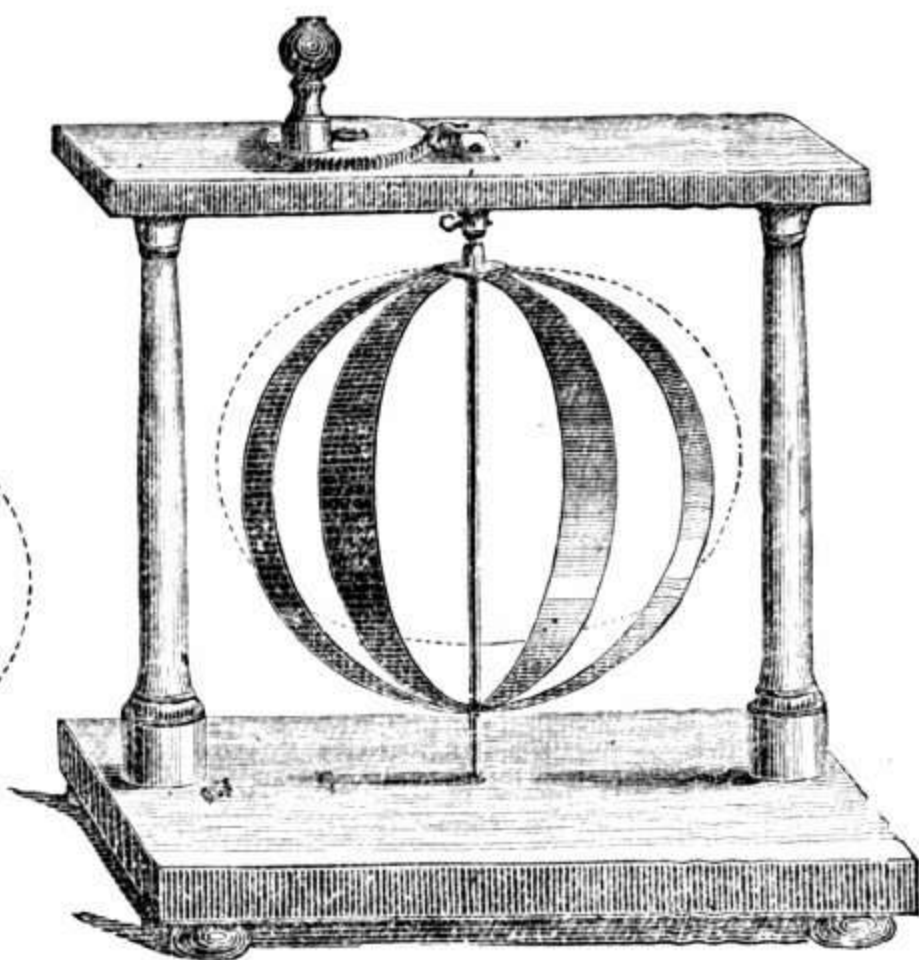

4076.

4075. <b>Whirling Machine.</b> A single hoop of spring brass, nine inches in diameter, with spool and cord for spinning. On a firm base and vertical rod of iron.....	3 00
4076. <b>Whirling Machine.</b> Table, 15½ inches high, by 17 inches wide. Eight illustrations. Consisting of double hoop of spring brass; a globe, oblate spheroid, prolate spheroid, and double cone of wood; a ring and a chain of brass, and a glass vessel containing mercury and a colored fluid.....	11 00
4077. <b>Prismatic Cylinder.</b> Of wood, four inches in diameter and covered with paper of the seven primary colors. To be attached to whirling machine No. 4076.....	2 00

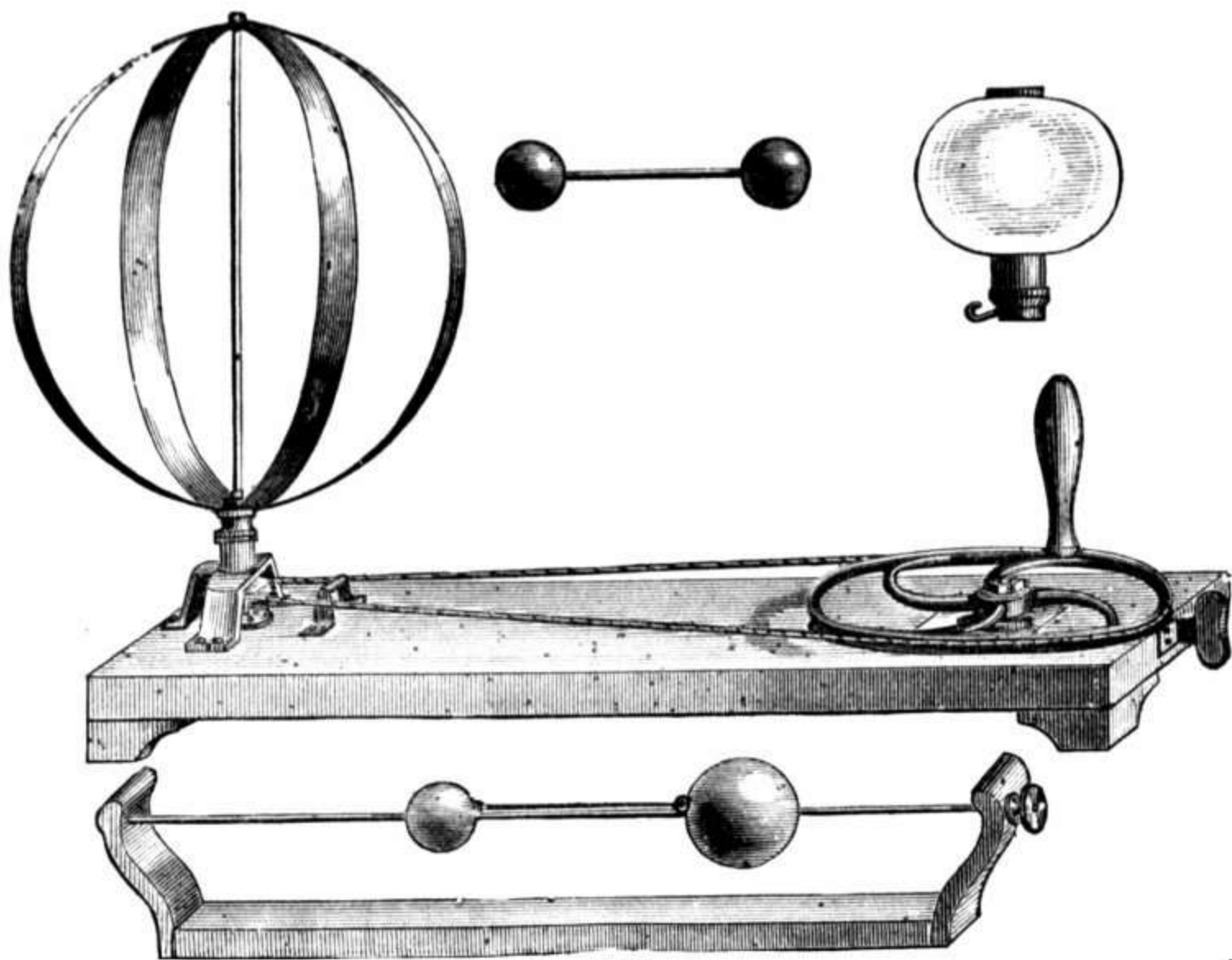

4078

PRICE

4078. **Whirling Table.** A strong base of mahogany, three and a half feet long, with iron driving-wheel, metallic spindles, accurately ground to their fittings, screw arrangement for tightening or loosening the cord and screw attachments, with key for fastening to the spindle :  
 1st. Double brass ring, twelve inches in diameter.  
 2d. Vase, open, for mercury, water, and other fluids of varying density.  
 3d. A strong mahogany frame, on which is stretched a wire, two equal balls connected by a tube, and two unequal ones connected by a strong rubber cord.  
 4th. A heavy ring of brass, from the top of which may be suspended a brass chain or ring, or wooden figures, as in No. 4076. \$40 00  
 Or finally, any of the following apparatus for rotation :

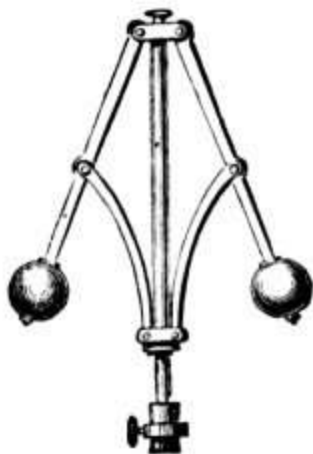

4079.

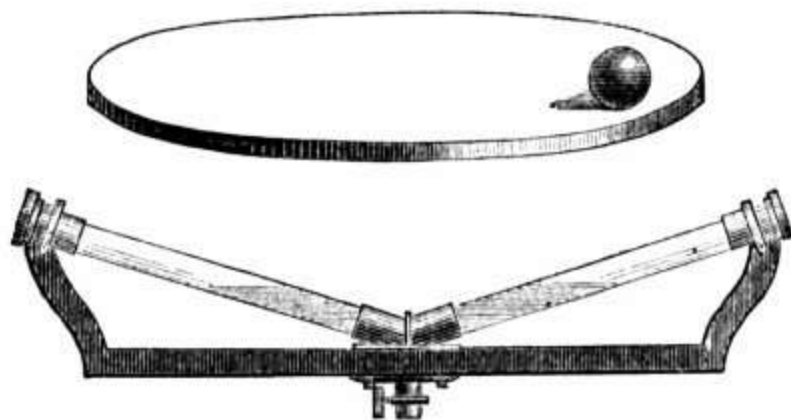

4080 and 4081.

4079. **Model of Steam Governor**, to be attached to No. 4078 ..... 8 00  
 4080. **Frame with Inclined Glass Tubes.** For liquids of different densities, to be attached to No. 4078..... 7 50  
 4081. **Inertia Table.** With heavy wooden ball attached to the centre by a cord. To be attached to No. 4078..... 4 00



4082.

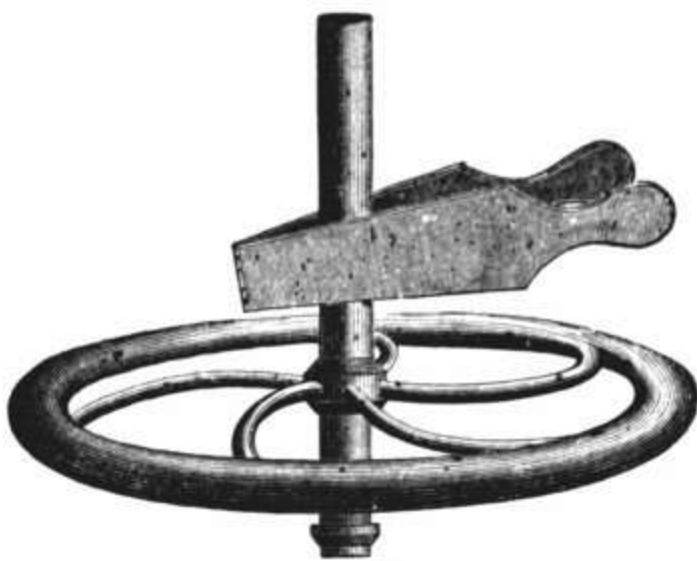

4083.

- |   | PRICE  |
|---|--------|
| 4082. <b>Globe of Glass, with Cork.</b> To show air-bubble at centre by attaching to No. 4078.....  | \$3 00 |
| 4083. <b>Heavy Fly-Wheel of Iron.</b> With screw attachments above and below, for attaching it to No. 4078, and for attaching various instruments to it, when steadiness and uniformity of rotation is necessary..... | 7 00   |

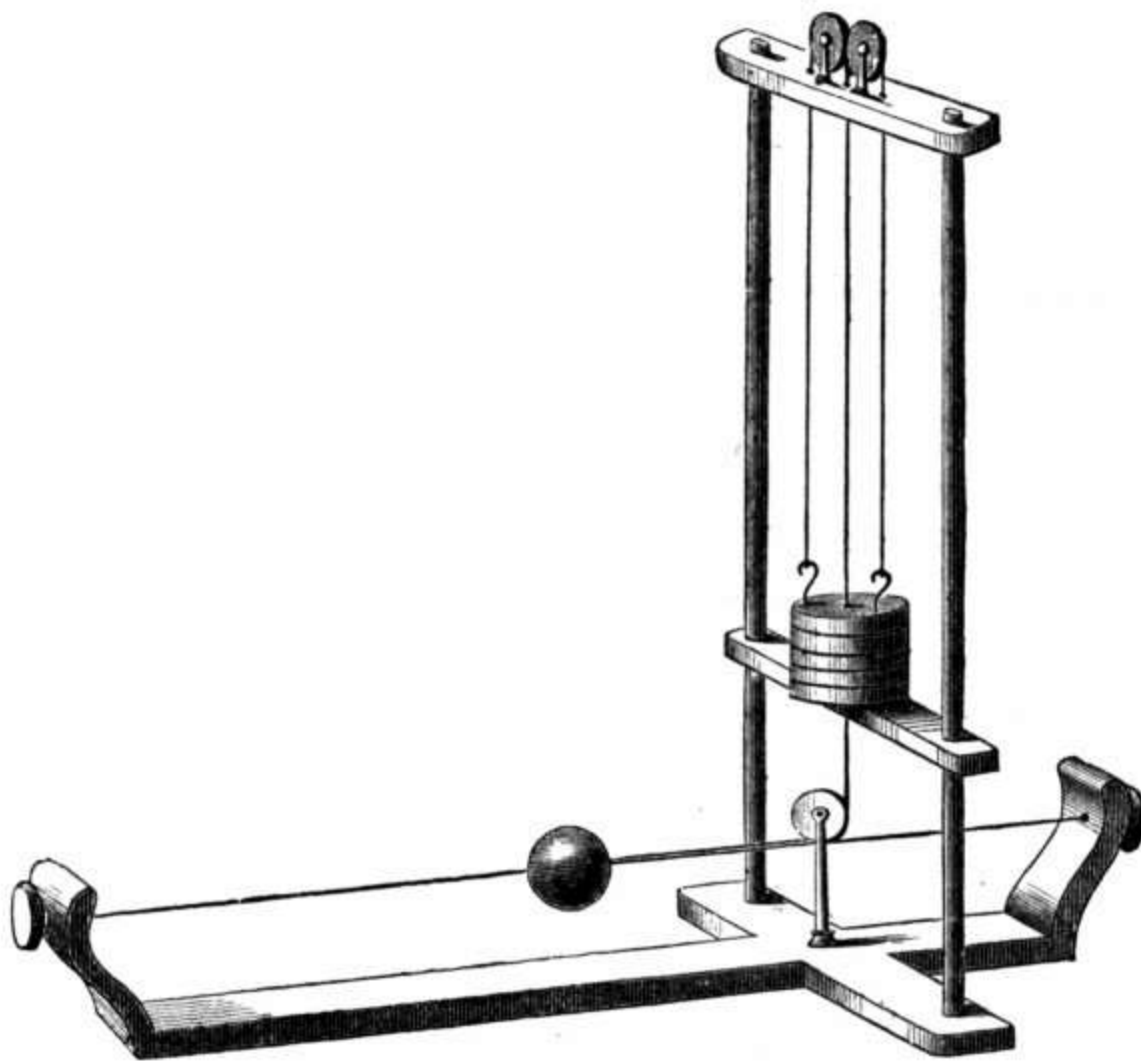

4084.

- |   |       |
|---|-------|
| 4084. <b>Instrument for Determining the Laws of Centrifugal Force.</b> To be attached to No. 4078.....  | 15 00 |
| 4085. <b>Register.</b> To be attached to the whirling table No. 4078, so that the exact number of revolutions per second can at any time be noted. This, with the fly-wheel, No. 4083, places the whole question of central forces under exact measurement..... |       |

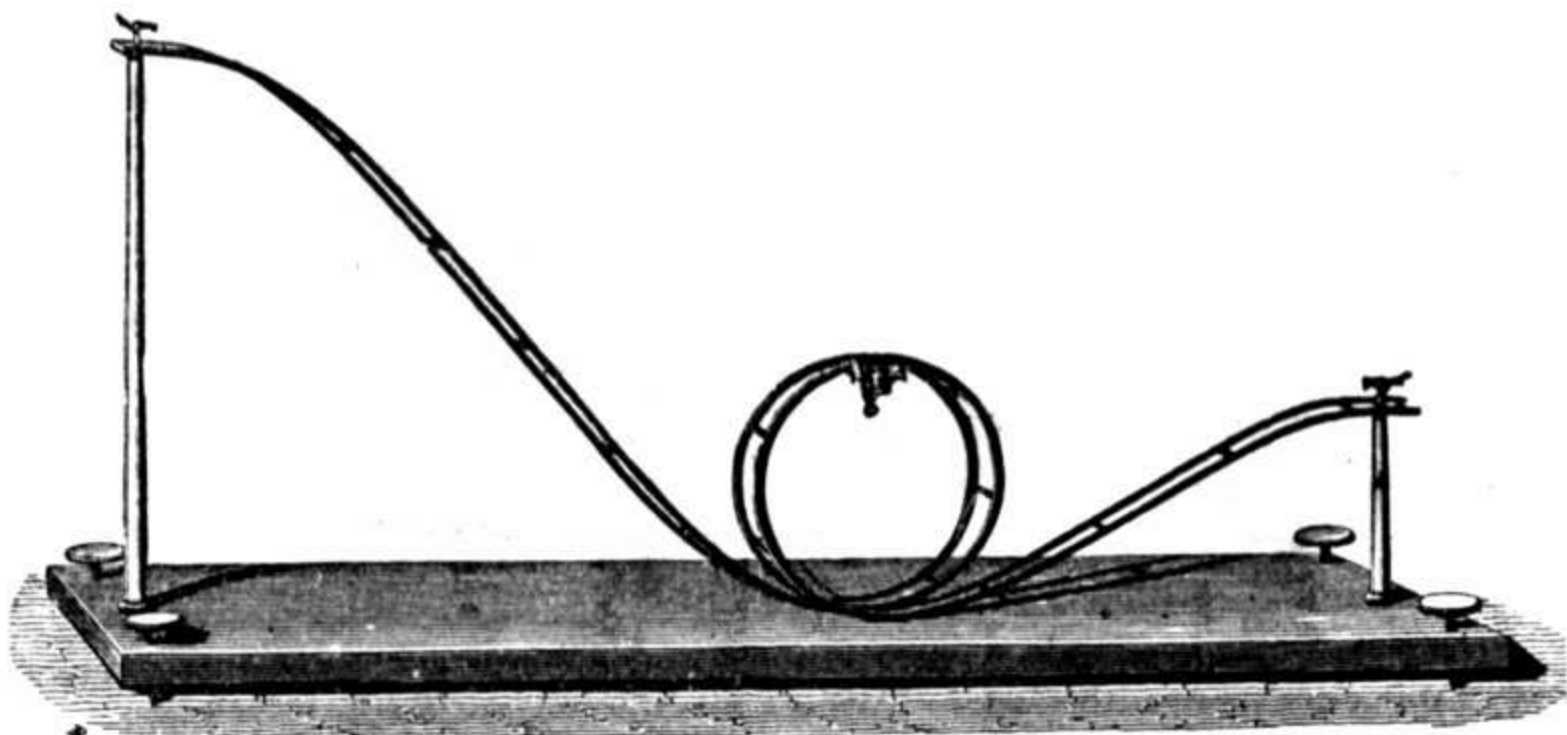

4087.

- |   | PRICE  |
|---|--------|
| 4086. Centrifugal Railroad. Of neatly japanned tin, three feet in length, with a ball.....                                    | \$3 50 |
| 4087. Centrifugal Railroad. Four feet long, of neatly japanned tin, on a wooden base with leveling screws and glass ball..... | 8 00   |

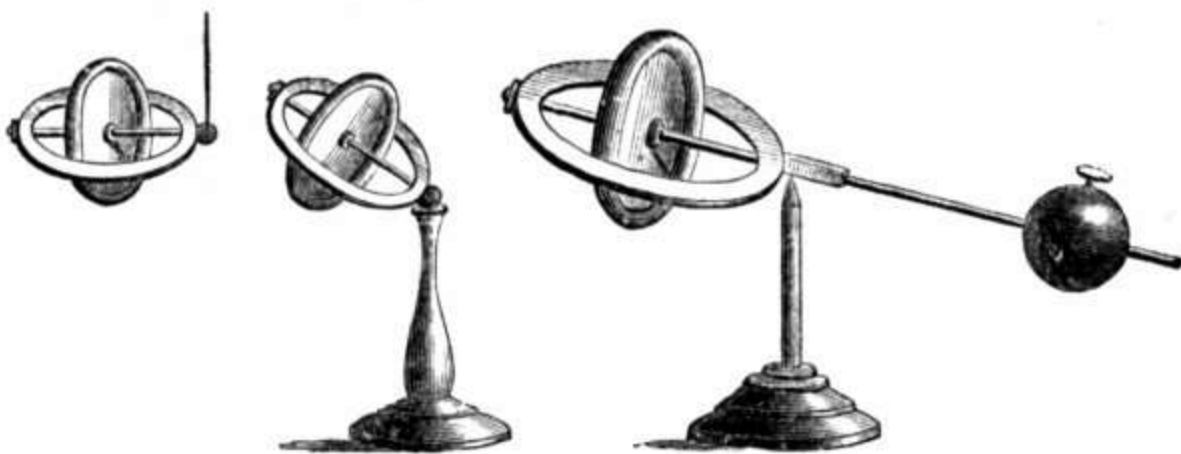

4088.

4089 and 4090.

- |   |      |
|---|------|
| 4088. Gyroscope Top. Wheel, 2½ inches in diameter.....  | 2 50 |
| 4089. Gyroscope. With three-inch wheel, of brass, with lever and balance-weight, supported on an upright pointed post of steel..... | 6 00 |
| 4090. Gyroscope. Similar to No. 4089, but with brass wheel four inches in diameter.....   | 8 00 |

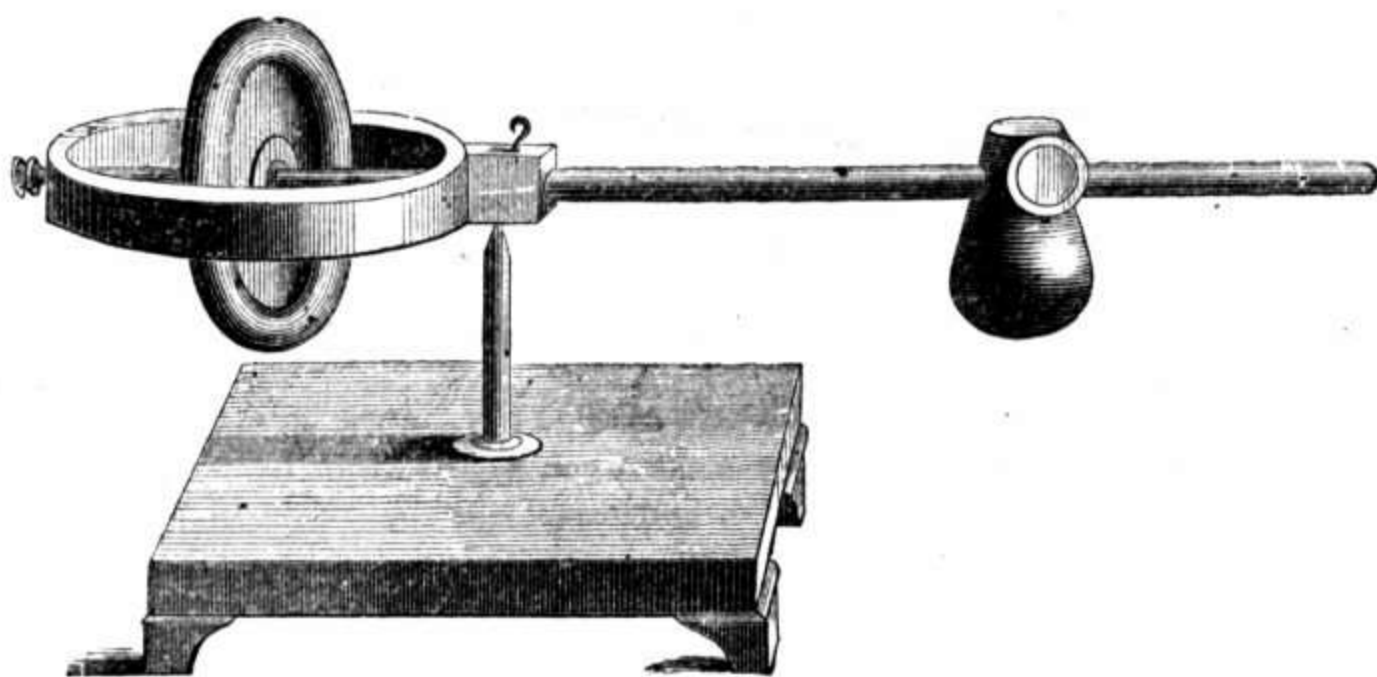

4091.



PRICE

4091. **Gyroscope.** Very superior. Wheel of brass, six inches in diameter, lever of brass, balance-weight of iron. This instrument admits of a smaller (three-inch wheel) gyroscope being attached to end of lever, and shows then the combined rotations very neatly. Supported on a strong steel upright and pointed post, fastened to a heavy base of polished mahogany..... \$30 00

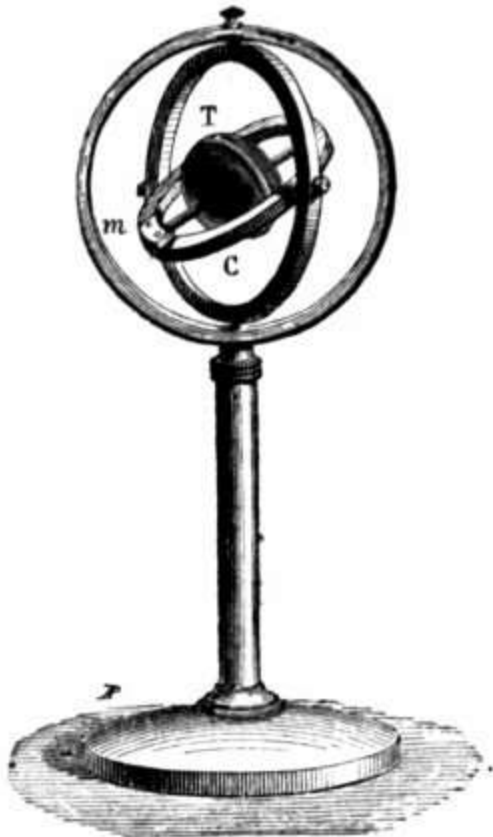

4092.

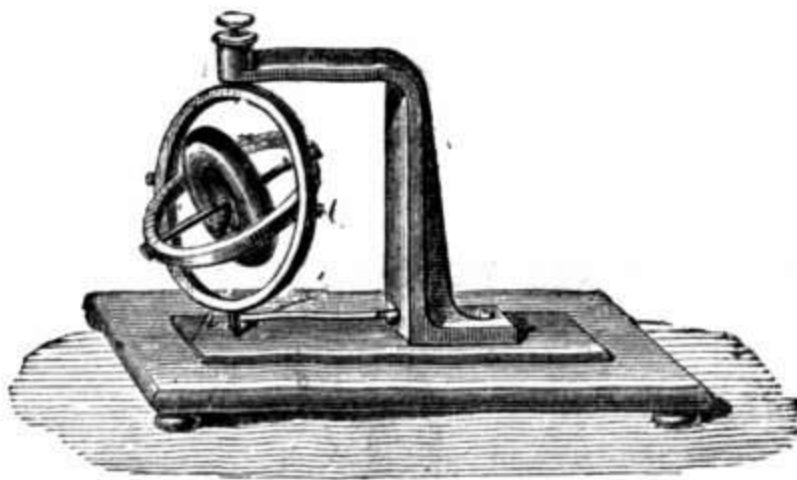

4093.

4092. **Bohnenberger's Apparatus.** All of brass, except axis and vertical support, which are of steel. Wheel four inches in diameter..... 12 00
4093. **Hardy's Inverting Gyroscope.** Base of mahogany, pillar and supporting arm of iron, neatly japanned, wheels of brass, four inches in diameter, with set of rubber cords..... 16 00

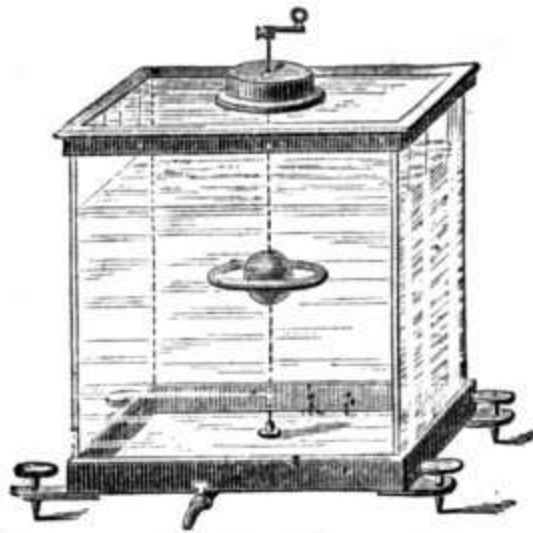

4095.

4095. **Plateau's Apparatus.** For showing the effects of rotation when the influence of terrestrial gravitation is removed. A glass tank, with vertical axle, crank, and disc.....D. F. 25 00

## CHAPTER II.

## INSTRUMENTS ILLUSTRATING THE PRINCIPLES OF MACHINERY.

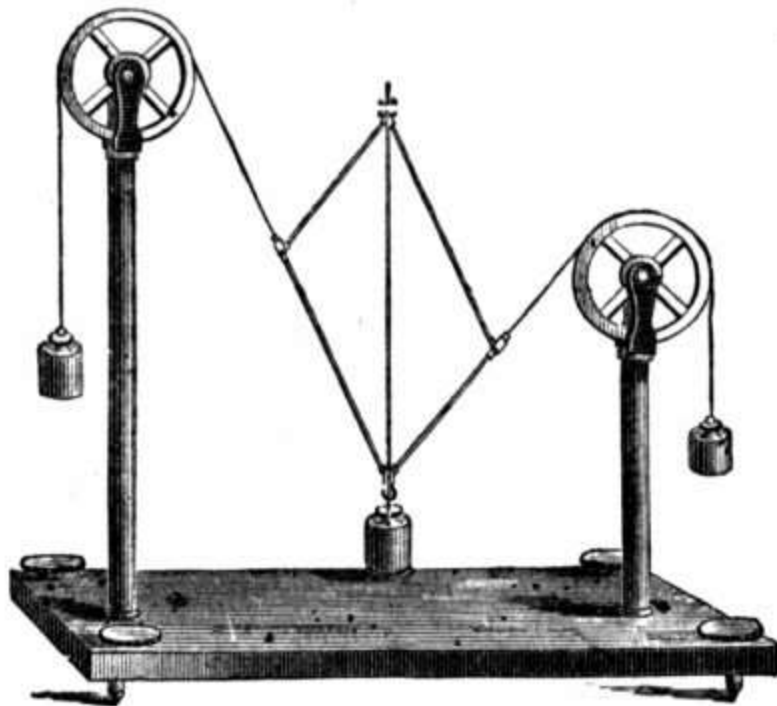

4101.

- |   |                 |
|---|-----------------|
| 4100. <b>Parallelogram of Forces.</b> A light, graduated hinged frame, without weights or pulleys, but with cord extensions.....  | PRICE<br>\$5 00 |
| 4101. <b>Parallelogram of Forces.</b> Very accurately and delicately made. Consisting of a very light, graduated frame with hinged joint; a pair of pulleys with bearings as perfect as possible, with set of weights, twelve in number, and each weighing two ounces. The whole supported upon two brass posts, eighteen and twelve inches in respective height, on base of polished mahogany..... | 25 00           |

4103. **Illustration of Pulleys.** Polished base of mahogany, from which rises a post of the same material, 26 inches high, with arm from which the systems are suspended one at a time; brass pulleys mounted with strong silk cord; each system counterpoised. The weights are made accurate, so that each system performs its work perfectly.

- 1st System. Fixed pulley, power and weight equal.
- 2d. One fixed and one movable pulley, power and weight, 1 : 2.
- 3d. One fixed and three movable pulleys, power and weight, 1 : 2, 1 : 4, or 1 : 8.
- 4th. One double fixed and one double movable pulley, in blocks, power and weight, 1 : 4.
- 5th. Capstan, with cord attached to 4th system.
- 6th. Wheel and axle, three radii, in proportion of 1, 2 and 4.

Set of weights from two to thirty-two ounces; smaller of brass, larger of iron..... \$30 00

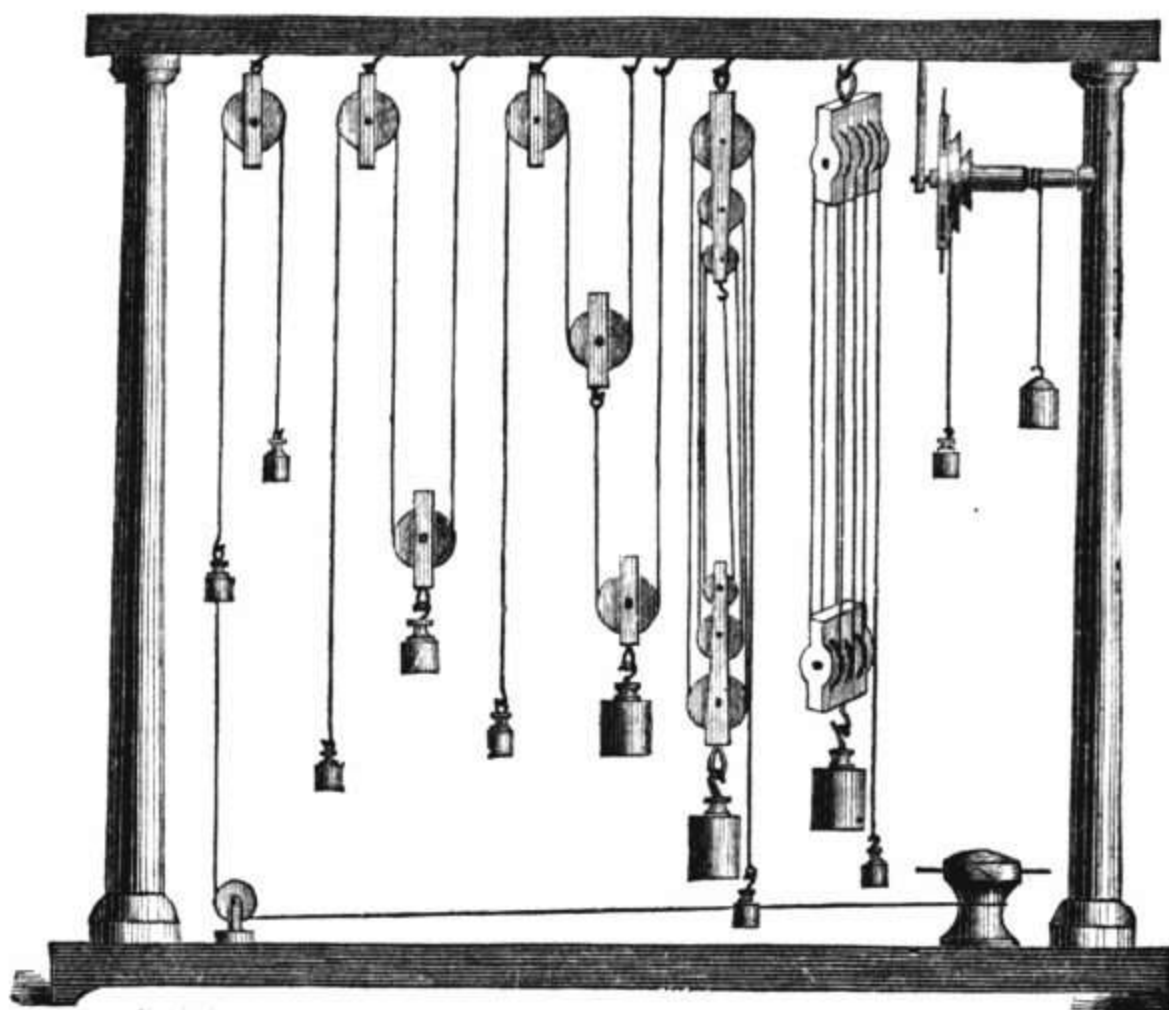

4104.

4104. **Illustration of Pulleys.** Polished mahogany frame, thirty inches long by thirty-six inches high; pulley-wheels of brass, two inches in diameter, mounted with strong silk cord. Each system counterpoised; every part, including the weights, made with the greatest accuracy, so that all the systems illustrate their respective laws with precision.

- 1st system. Fixed pulley, power and weight equal.
- 2d system. One fixed and one movable pulley, power and weight, 1 : 2.
- 3d system. One fixed and two movable pulleys, power and weight, 1 : 2 and 1 : 4.
- 4th system. One fixed block of three pulleys of different sizes, and one movable pulley of same character, power and weight, 1 : 6.
- 5th system. One fixed block with four pulleys of same size, and one movable of same kind, power and weight, 1 : 8.

- 6th system. Wheel and axle, three radii in proportion of 1, 2, and 4.  
 7th system. Capstan, cord attached to 1st system of pulleys.  
 Set of brass weights from one ounce to thirty-two ounces..... \$45 00

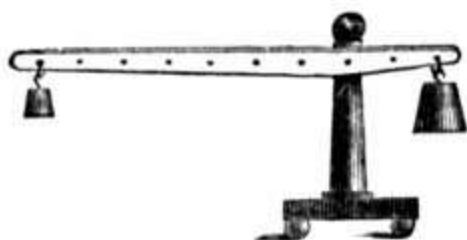

4106.

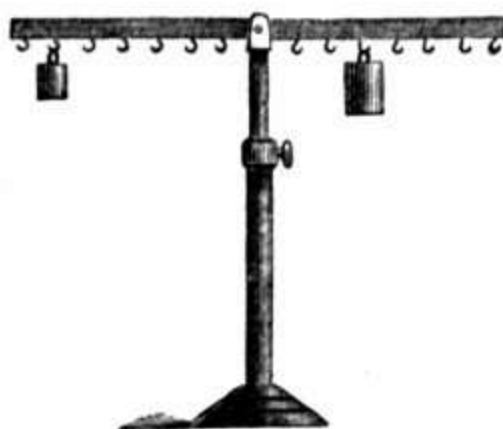

4107.

4105. Simple Lever, with Fulcrum..... 1 00  
 4106. Simple Lever. Of brass, eight inches long, mounted on a pivot in a base of mahogany, weights of brass, one, two and four ounces. .... 4 00  
 4107. Simple Lever and Steelyard. Beam of brass, twelve inches long, mounted on brass post, with friction points; weights of brass, one, two, four and eight ounces; an additional two-ounce weight to show equilibrium at equal distances from the fulcrum..... 7 00

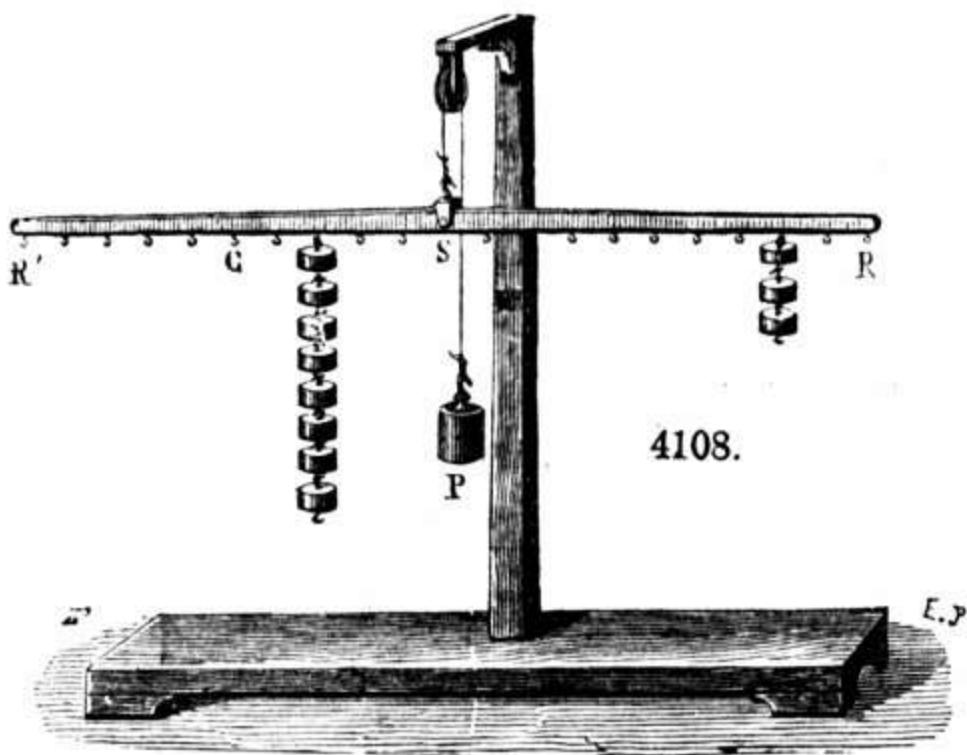

4108.

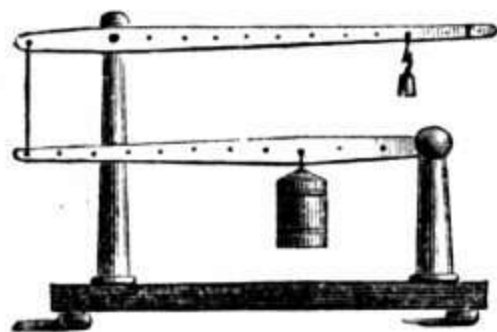

4110.

4108. Apparatus for demonstrating the composition of parallel forces..... 20 00



4111 and 4112.

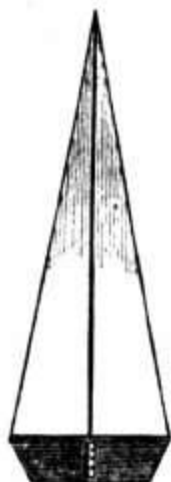

4113 and 4114.

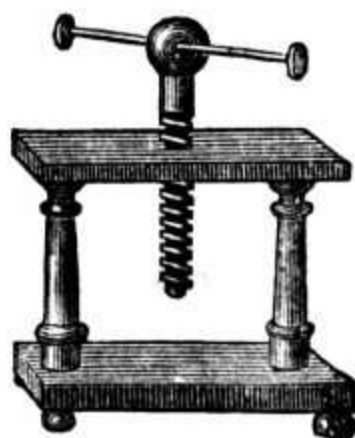

4115 and 4116.

GRAVITATION.

15

PRICE

4109. <b>Compound Levers.</b> Base, pillar, and levers of mahogany.....	\$3 75
4110. <b>Compound Levers.</b> Base and posts of mahogany, beams of brass, weights of brass and iron, from two ounces to a pound.....	9 00
4111. <b>Inclined Plane with Car.</b> Plane fourteen inches long, of cherry, and adjustable to any angle with the base, by a graduated quadrant and binding screw; wheels of car, pulleys, and weights of brass; weights one, two, four and eight ounces.....	6 00
4112. <b>Inclined Plane with Car.</b> Base and frame of polished mahogany; plane twenty inches long, of plate-glass; pulleys and weights, from one to eight ounces, of brass.....	12 00
4113. <b>Wedge of Cherry.</b> Eight inches long, in two parts, hinged.....	1 50
4114. <b>Wedge of Mahogany.</b> Twelve inches long, in two parts, hinged....	2 50
4115. <b>Screw.</b> Six inches long, in frame of cherry.....	2 50
4116. <b>Screw.</b> Ten inches long, in frame of finely polished mahogany.....	4 00

---

CHAPTER III.

GRAVITATION.

SECTION 1.—INSTRUMENTS FOR DETERMINING THE FORCE OF GRAVITY.

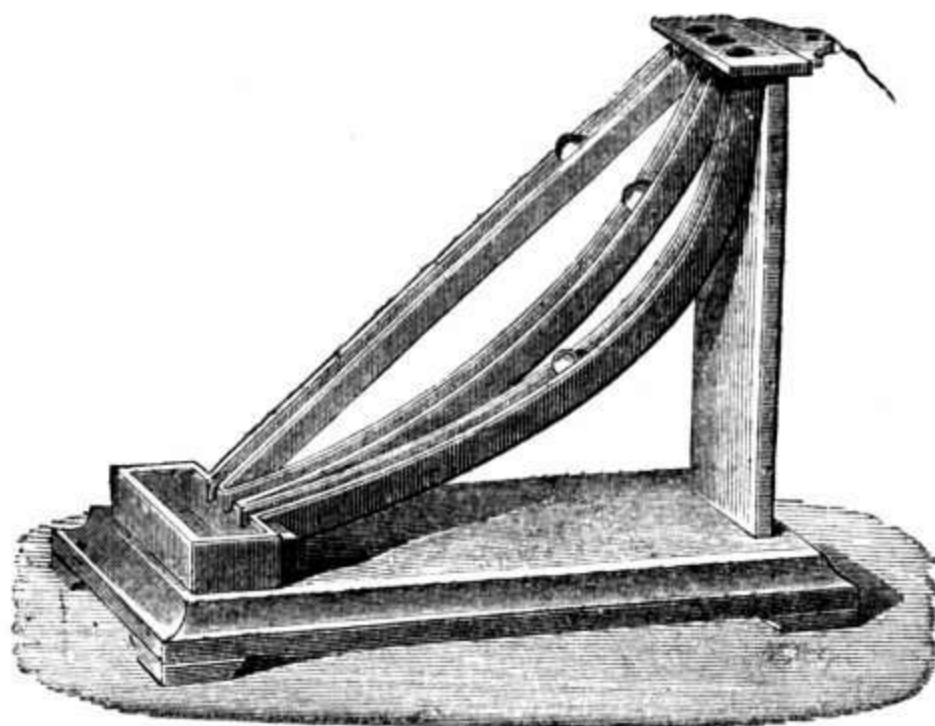

4124.

4124. <b>Swiftest Descent Apparatus.</b> Consisting of a mahogany frame, four feet on base, carrying three inclined planes; one a straight plane, one a circular, and one a cycloidal, with arrangement for starting three balls at the same instant, and a box to catch them at the end of their course.....	18 00
4124½. <b>Apparatus for demonstrating the parabolic curves of falling liquids, and for verifying the laws of the motion of projectiles.....</b>	20 00

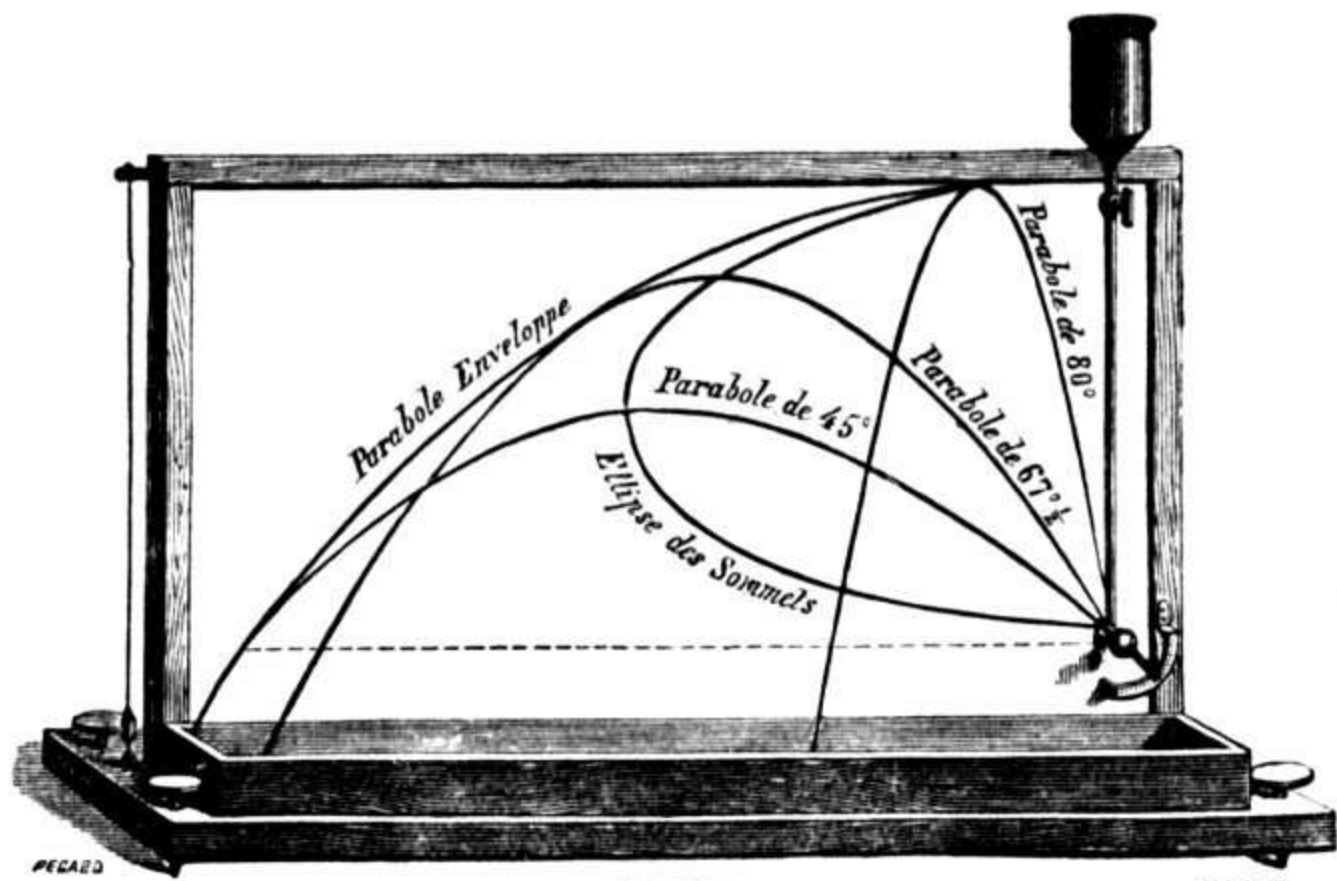

4124½

PRICE

- |   |  |
|---|--|
| <p>4125. <b>Pendulum Apparatus.</b> Base and pillar of polished mahogany, with arm of brass, supporting two seconds' pendulums, one with solid brass ball, the other with a hollow one; and two other pendulums, with solid balls, one one-fourth, the other one-ninth the length of the seconds' pendulum.....</p> <p>4126. <b>Seconds' Pendulum, with Clock Escapement.</b> Mounted on mahogany base and stand. Pendulum with dead beat.....</p> <p>4128. <b>Atwood's Machine, with Automatic Movement.</b> Strong pillar of polished mahogany on base of the same material, with leveling screws. Pulley-wheel eight inches in diameter, with steel axis, working on delicate pivots. Side graduated scale, carrying sliding platforms of brass. Pendulum beating seconds, which rings at every stroke a small bell. A simple contrivance starts the weight at the instant the pendulum passes the perpendicular; at every subsequent passage it rings the bell. Weight for momentum in three equal sections.....</p> <p>4129. <b>Atwood's Machine.</b> Same as No. 4127, but with an electro-magnetic connection, to release the weight at the proper instant, and ring the bell.....</p> <p>4130. <b>Set of friction wheels and glass cover for either of the Atwood Machines.....</b></p> | <p>8 00</p> <p>15 00</p> <p>85 00</p> <p>100 00</p> <p>25 00</p> |
|---|--|

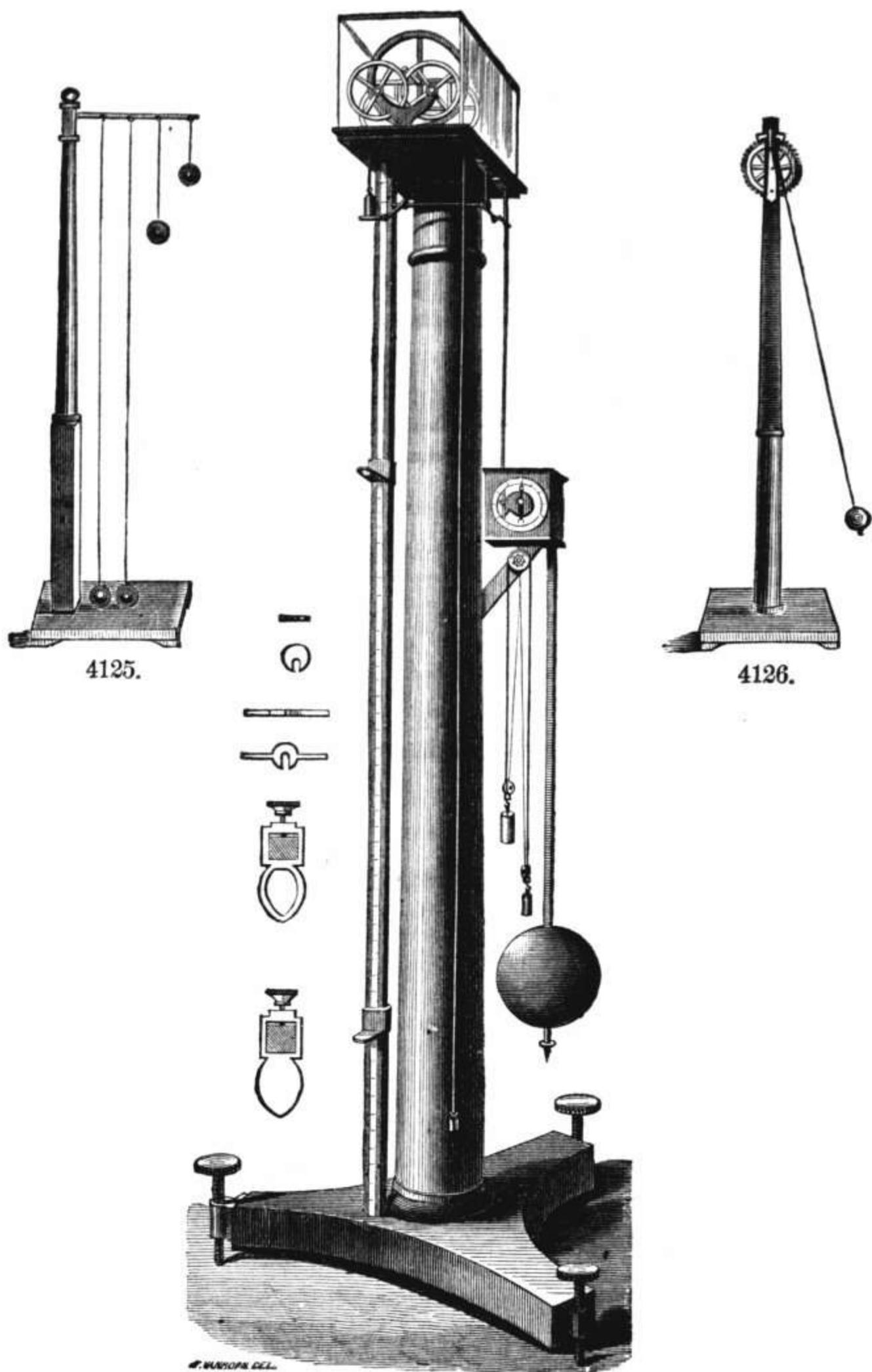

SECTION II.—CENTRE OF GRAVITY, OR EQUILIBRIUM OF SOLIDS

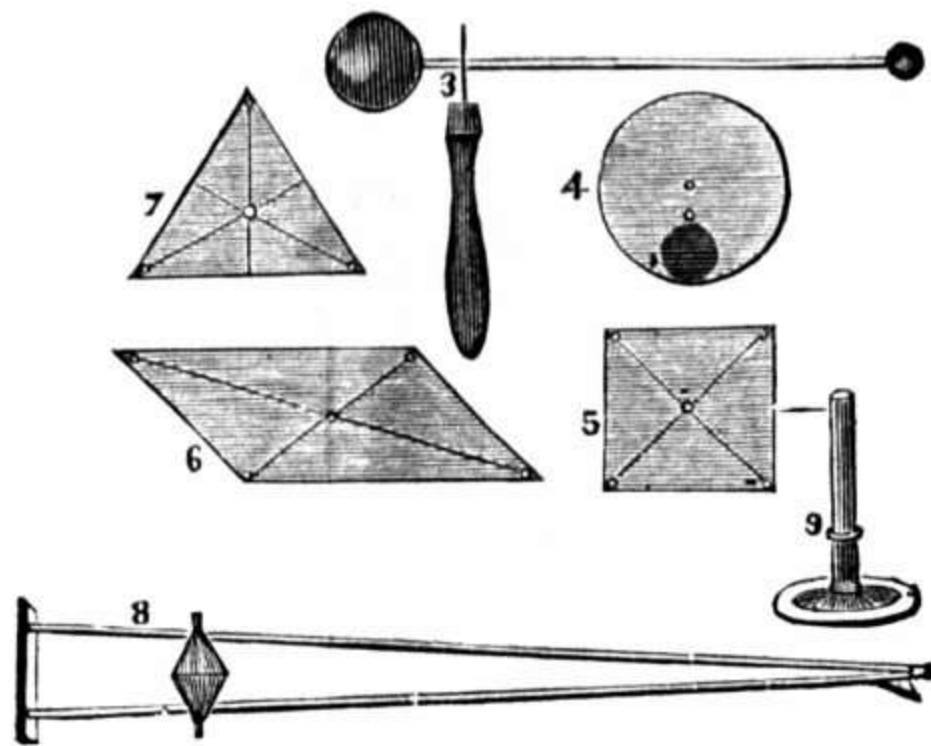

4140.

4140. **Centre of Gravity.** A set of nine illustrations, consisting of a cone, plumb-line, leaning tower, with two centres of gravity; three blocks of different figures, with centres of gravity and suspension marked on them; loaded wheel, with holes for suspension at centre of figure and centre of gravity; double cone, on inclined plane; figure of horse or man, balanced; two balls, connected by a rod pierced at the centre of gravity of the pair, and a handle for suspension.....

PRICE

\$8 00

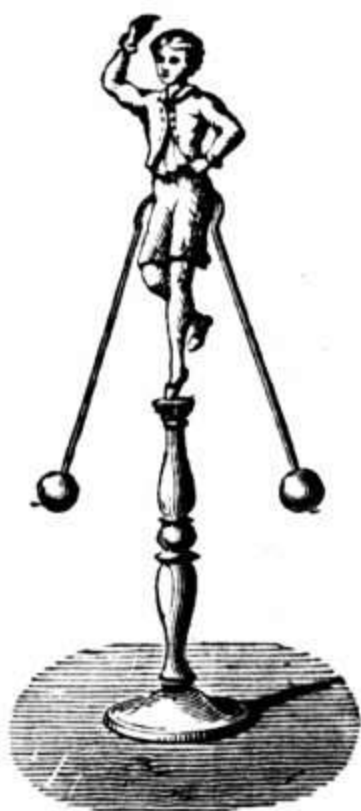

4144.



4145.

- |  |      |
|--|------|
| 4142. <b>Mechanical Paradox.</b> A double cone and frame of mahogany.....    | 1 25 |
| 4143. <b>Leaning Tower.</b> With two centres of gravity.....                 | 2 00 |
| 4144. <b>A Blondin.</b> Balanced on one foot, on neat mahogany stand.....    | 3 00 |
| 4145. <b>The Waltzers.</b> A pair of figures, attached to a convex lens..... | 75   |



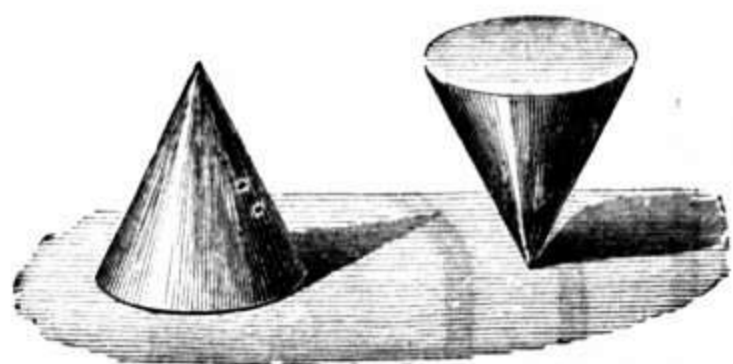

4146.

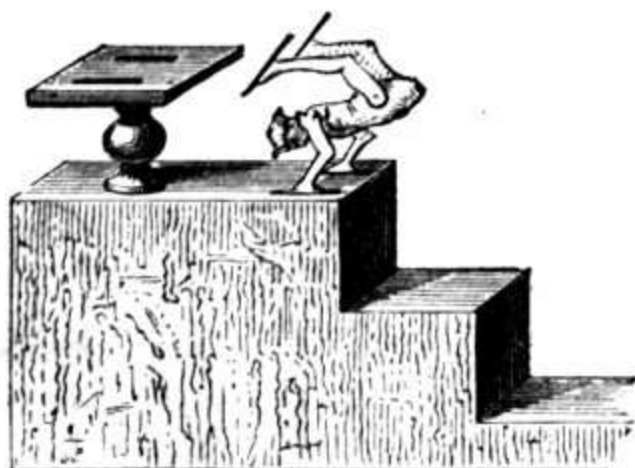

4147

	PRICE
4146. <b>Equilibrium Figures.</b> Two cones of cherry, each four inches high..	\$1 50
4147. <b>Chinese Tumblers.</b> Stairs 10 inches long at base.....	3 00
4148. Chinese Tumblers. Stairs 12 inches long .....	
4149. Chinese Tumblers. Stairs 14 inches long .....	

SECTION III.—EQUILIBRIUM OF LIQUIDS AND SPECIFIC GRAVITY.

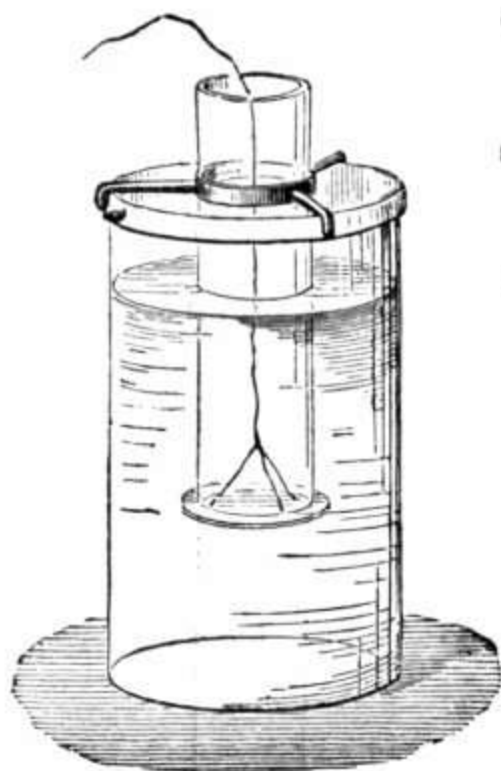

4161.

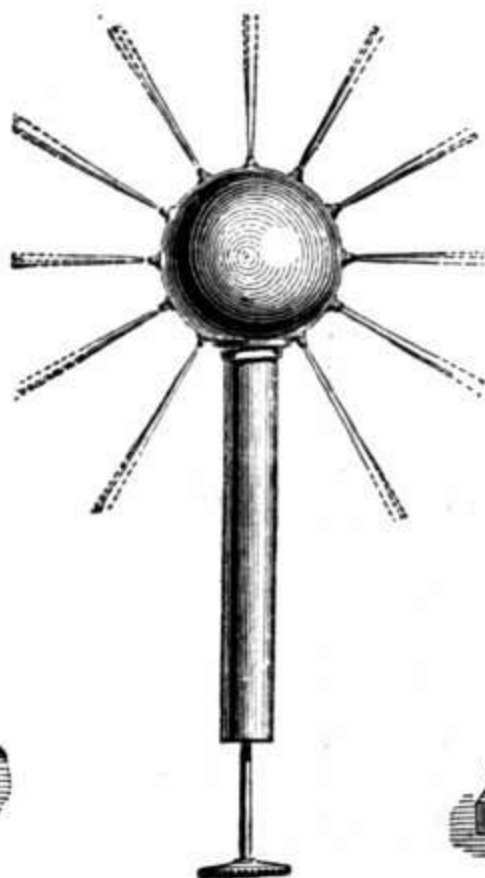

4162.

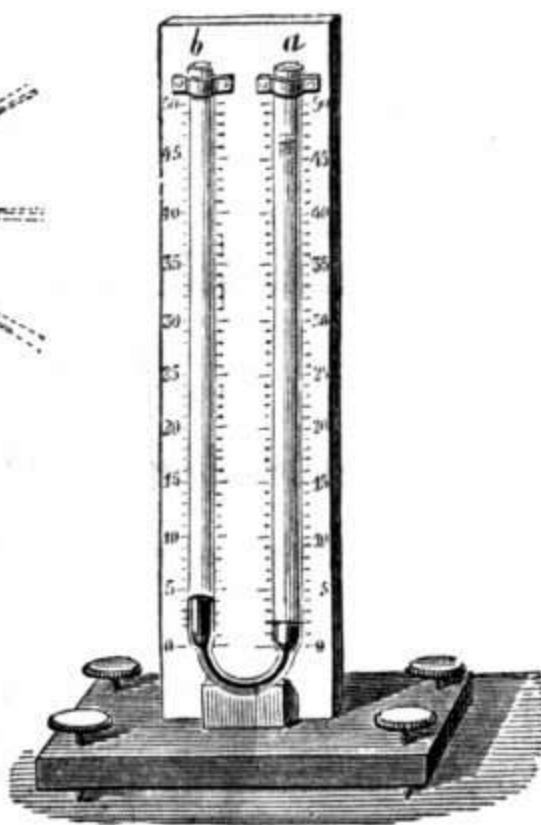

4165.

4160. <b>Upward Pressure Apparatus.</b> Glass tube with ground flange at one end, and a brass plate with cord attached, without frame or water-jar.....	2 00
4161. <b>Upward Pressure Apparatus.</b> Same as No. 4160, but with a gallon vessel of glass, and a strong frame to support the tube, as shown in the figure.....	5 00
4162. <b>Apparatus to Demonstrate the Equality of Pressure in all Directions</b> .....	12 00

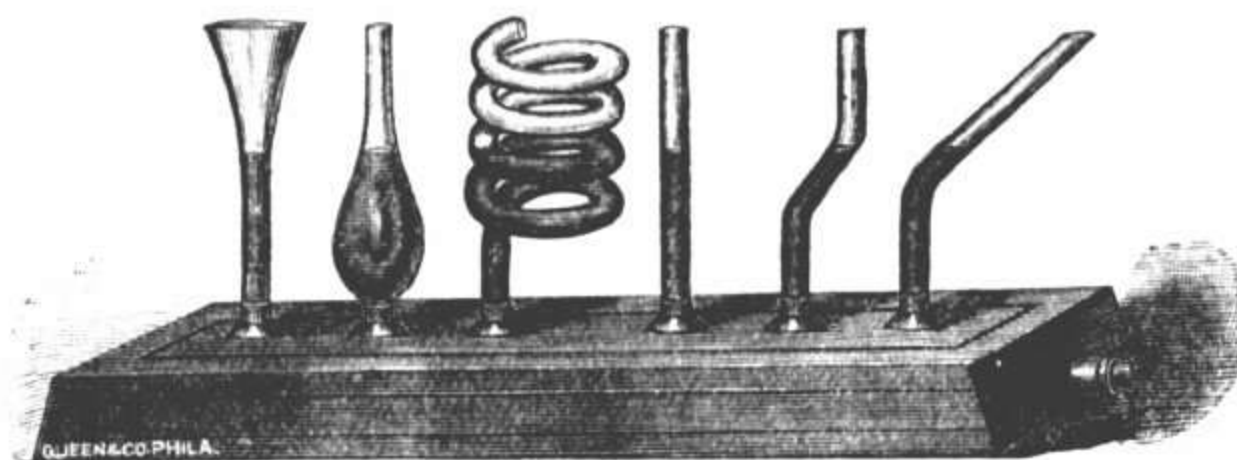

4163

- |  | PRICE  |
|--|--------|
| 4163. <b>Equilibrium Tubes.</b> Set of six forms, six inches high, mounted in a base of tin neatly japanned.....   | \$3 75 |
| 4164. <b>Equilibrium Tubes.</b> Set of six forms six inches high, in brass sockets, screwing into fittings in a connecting tube of brass, on a mahogany base.....  | 8 00   |
| 4165. <b>Equilibrium Tubes for different liquids.</b> Pair of glass tubes, cemented into iron fittings which are connected by a small iron tube; mounted on a neat mahogany frame, with graduated scale on each arm..... | 8 50   |



4166.

4167

- |   |       |
|---|-------|
| 4166. <b>Equilibrium Vases.</b> A set of six forms, ten inches high, of glass, in brass sockets, with brass connecting tube, mounted on heavy iron base | 12 00 |
| 4167. <b>Balloon and Car.</b> With jar fifteen inches high.....   | 3 00  |
| 4168. <b>Balloon and Car.</b> Without jar of No. 4167.....  | 2 00  |
| 4169. <b>Bottle imp.</b> With bottle.....   | 1 50  |
| 4170. <b>Bottle imp.</b> Small bottle.....  | 75    |



4172.

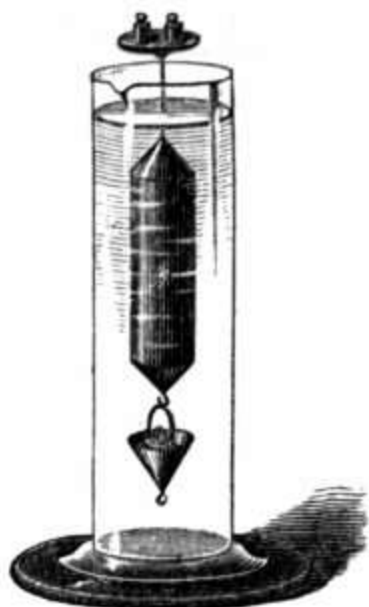

4173.



4184-85

	PRICE
4172. <b>Archimedes Principle.</b> A brass bucket, with a solid piece of brass fitting it accurately within, and a glass tumbler.....	\$3 25
4173. <b>Nicholson's Balance.</b> Of brass, with glass water-jar.....	5 50
4174. <b>Nicholson's Balance.</b> Of brass, without water-jar.....	4 50
4180. <b>One Thousand Grain Bottle.</b> With perforated glass stopper and brass counterpoise, in neat tin case.....	3 00
4181. <b>One Thousand Grain Bottle.</b> With mark on the neck, and brass counterpoise, but no stopper, packed in neat tin case.....	
4184. <b>Hydrometer.</b> For liquids lighter than water, from sp. gr. 1,000 to 700. In paper case....	2 00
4185. <b>Hydrometer.</b> For liquids heavier than water, from sp. gr. 1,000 to 1,933. In paper case.....	2 00
4186. <b>Hydrometer Jar.</b> Plain, 15 inches high.....	65
4187. <b>Hydrometer Jar.</b> With lip, 15 inches high.....	75

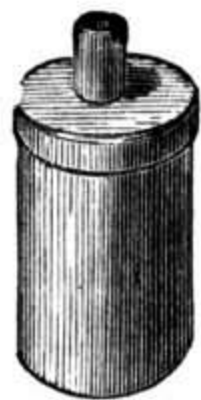

4180.



4180.



4191.

- |   | PRICE   |
|---|---------|
| 4191. <b>Queen's New Specific Gravity Balance.</b> Improved brass beam 16 inches long, beam and pans both swing on delicate knife edges, mounted on neat elevating stand. This instrument is very delicate, turning with one-fourth of a grain, and yet bearing a good load. Price, without weights ..... | \$15 00 |

We can furnish the French or English weights as desired.

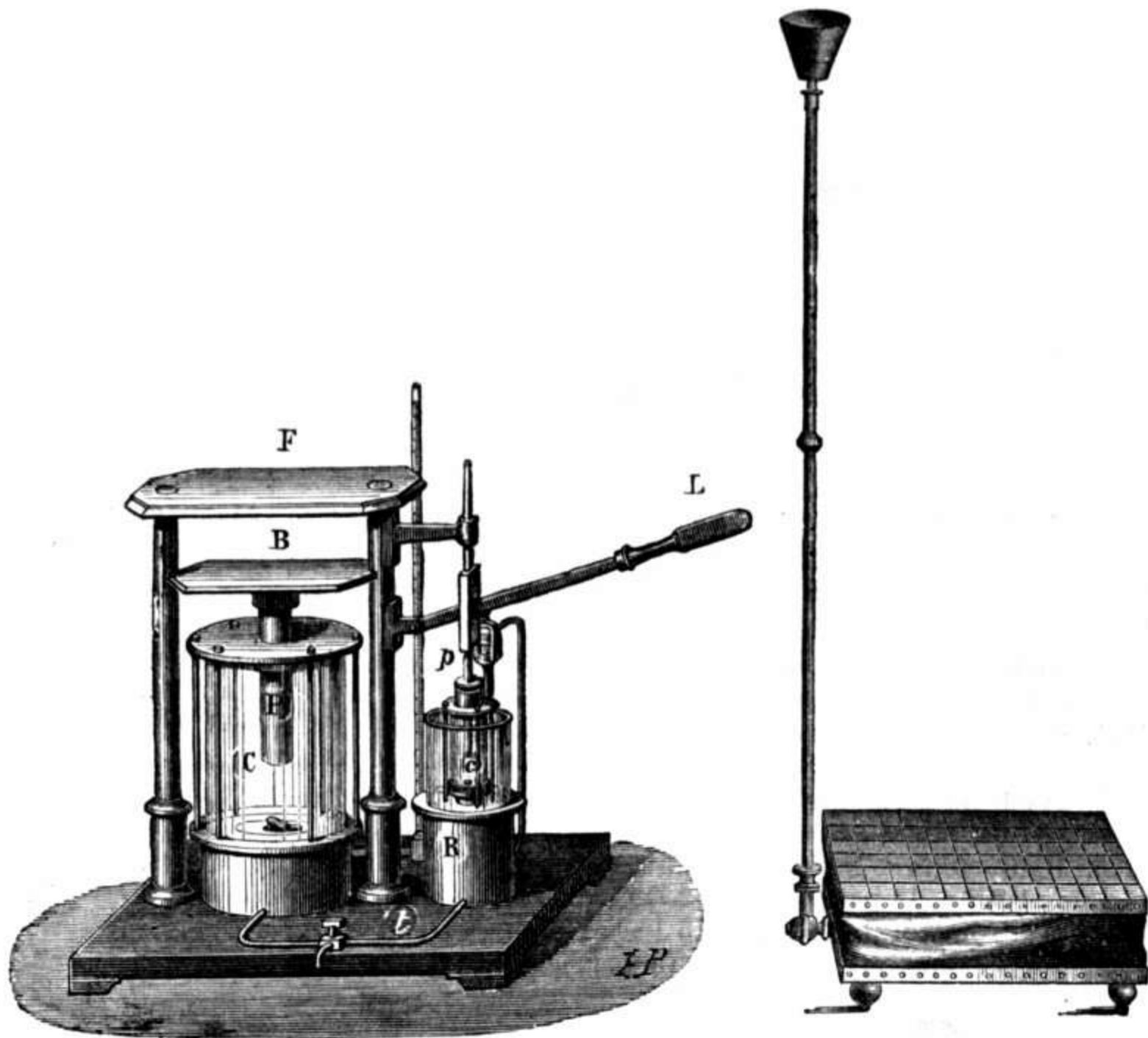

4195

4193.

- |   |       |
|---|-------|
| 4192. <b>Pascal's Vases.</b> Three glass vessels of different sizes and shapes, with brass fittings. Tripod and index-holder of iron, brass disc, with silk cord, and glass tank for the water..... | 15 00 |
| 4193. <b>Hydrostatic Bellows.</b> Bellows with mahogany top and base, leather sides, lined with rubber. Top 12 inches square. Brass and glass tubes, to contain the pressure column.....            | 18 00 |
| 4195. <b>Hydraulic Press.</b> Educational model, of brass, mounted on cast iron base, with cistern; large barrel, four inches in diameter.....  | 40 00 |

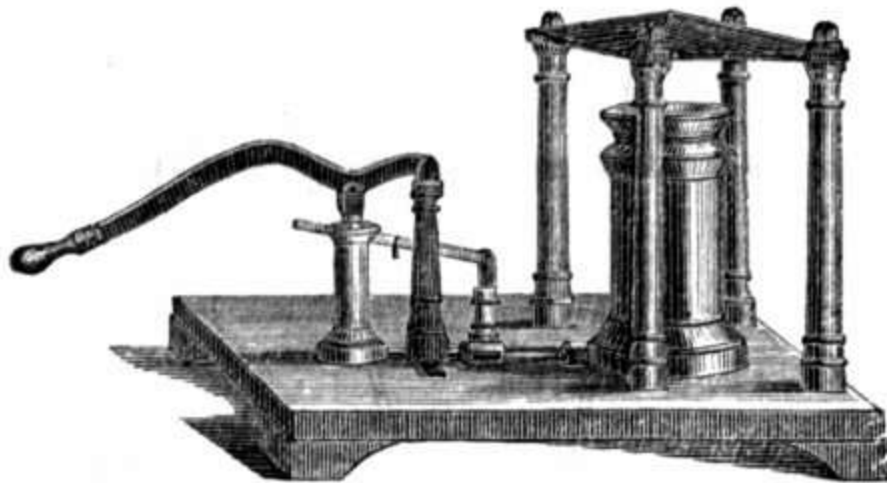

4196.

4196. **Hydraulic Press.** Working model. Same as No. 4195, but with posts of strong brass, top of frame and piston of wrought iron. All mounted on strong mahogany frame ..... **PRICE** \$60 00

SECTION IV.—INSTRUMENTS EXEMPLIFYING THE PRINCIPLES OF EQUILIBRIUM.

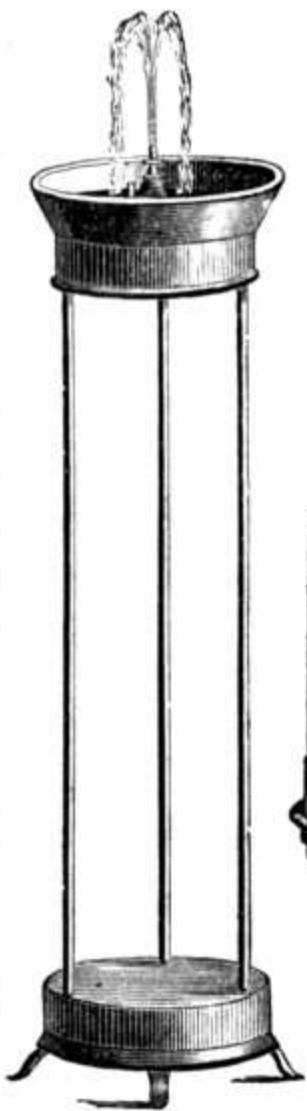

4200.

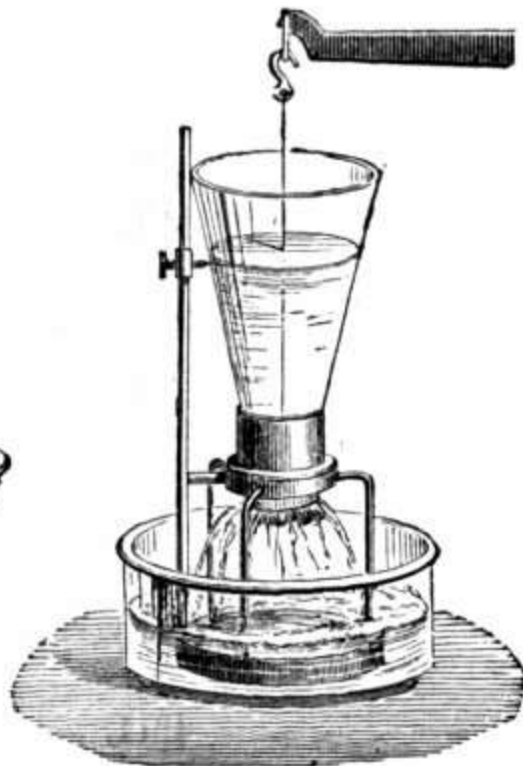
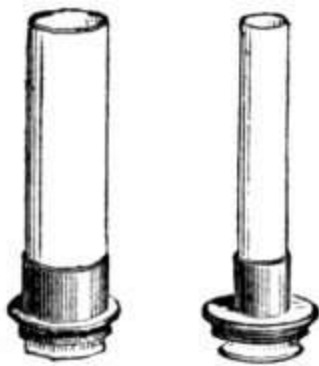

4192.



4201.

4200. **Hero's Fountain.** Cistern and vase of tin, tubes of brass. Thirty inches high..... 10 00  
 4201. **Hero's Fountain.** Cisterns and vase of glass, and mountings of brass, finely finished. Thirty inches high ..... 22 00

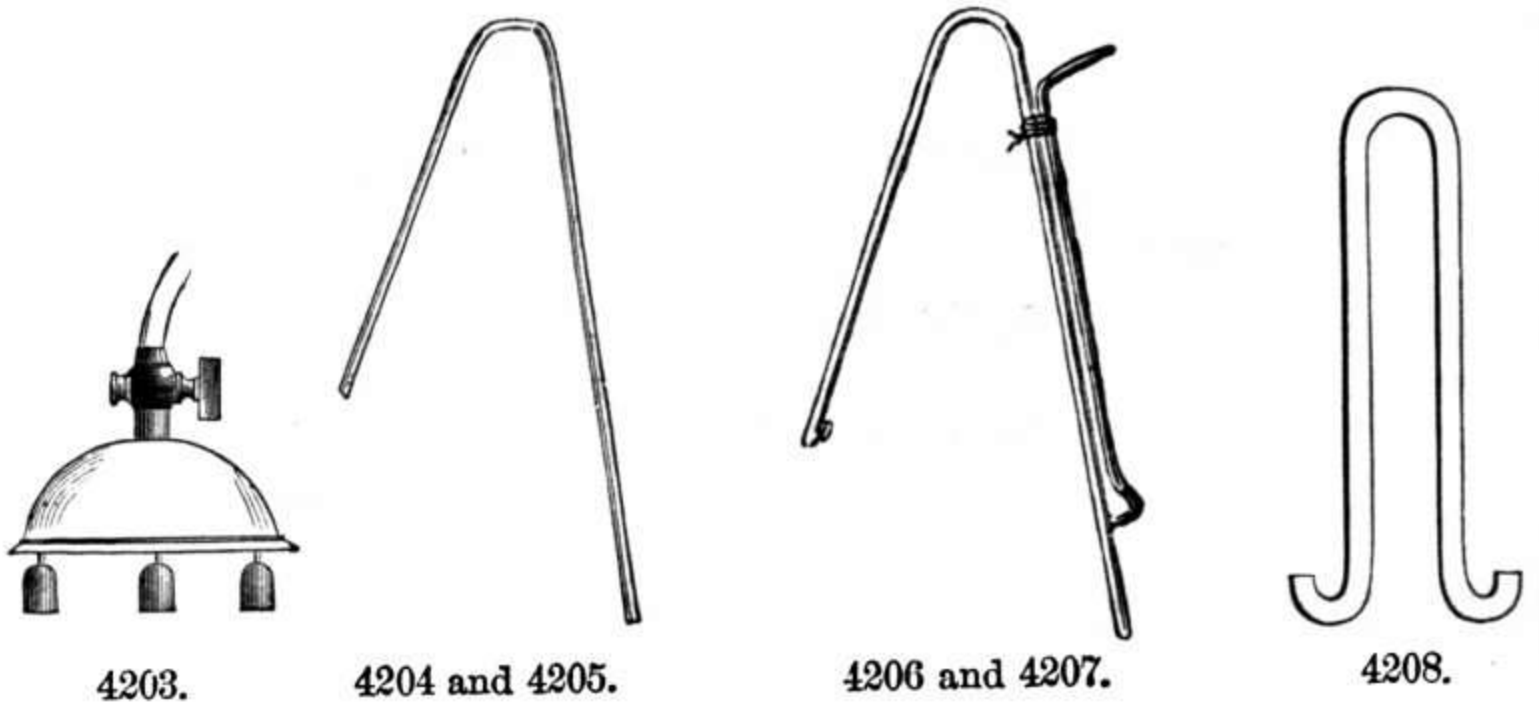

	PRICE
4202. <b>Diving Bell.</b> Glass model, six inches in diameter, with sinking weights of lead, and three feet of rubber hose.....	\$4 00
4203. <b>Diving Bell.</b> Glass model, six inches in diameter, with sinking weights of japanned iron, brass cap and stop-cock, with three feet of rubber hose.....	6 00
4204. <b>Plain Siphon.</b> Of glass tube; long arm, twenty inches in length....	40
4205. <b>Plain Siphon.</b> Of brass tube, half inch in diameter; long arm, twenty inches.....	1 00
4206. <b>Siphon with Suction Tube.</b> Of glass; long arm, twenty inches.....	75
4207. <b>Siphon with Suction Tube.</b> Of brass; long arm, fifteen inches.....	2 00
4208. <b>Wirtemberg Siphon,</b> Of glass tube, five-eighths of an inch diameter, arms each twenty inches long.....	75



4209.

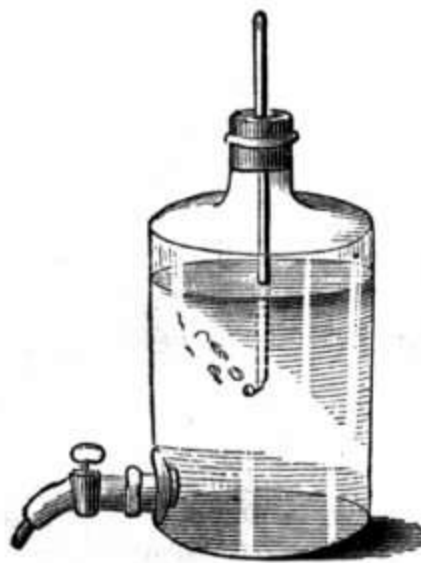

4211.



4212.

4209. <b>Tantalus Cup</b> .....	1 50
4210. <b>Mariotte's Vase,</b> Of glass, with rubber corks and glass tubes.....	3 00
4211. <b>Mariotte's Vase.</b> Of glass, with brass fittings.....	6 00
4212. <b>Intermittent Fountain,</b> Double basin of neatly japanned tin, inner one twelve inches in diameter, tubes and reservoir of glass, fittings of brass .....	12 50



4216.



4217.

	PRICE
4215. <b>Magic Funnel.</b> Of tin, neatly japanned.....	\$1 50
4216. <b>Magic Bottle.</b> Of tin, neatly japanned. A bottle from which the experimenter may pour four different fluids at will, without refilling.	5 50
4217. <b>Magic Sieve.</b> Bottle of tin, neatly japanned, with bottom of fine wire gauze.....	2 00

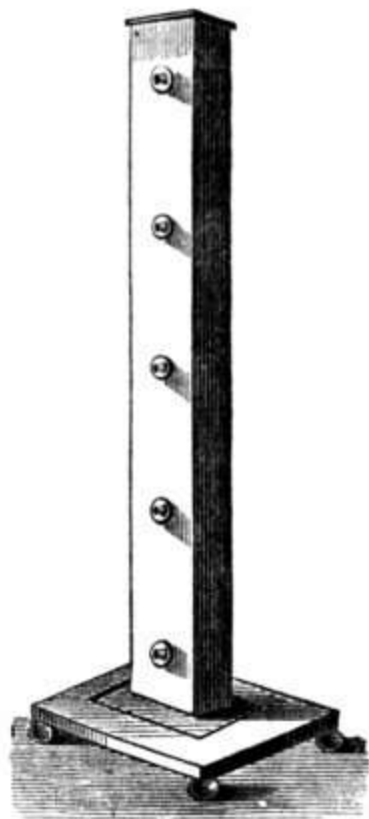

4220.

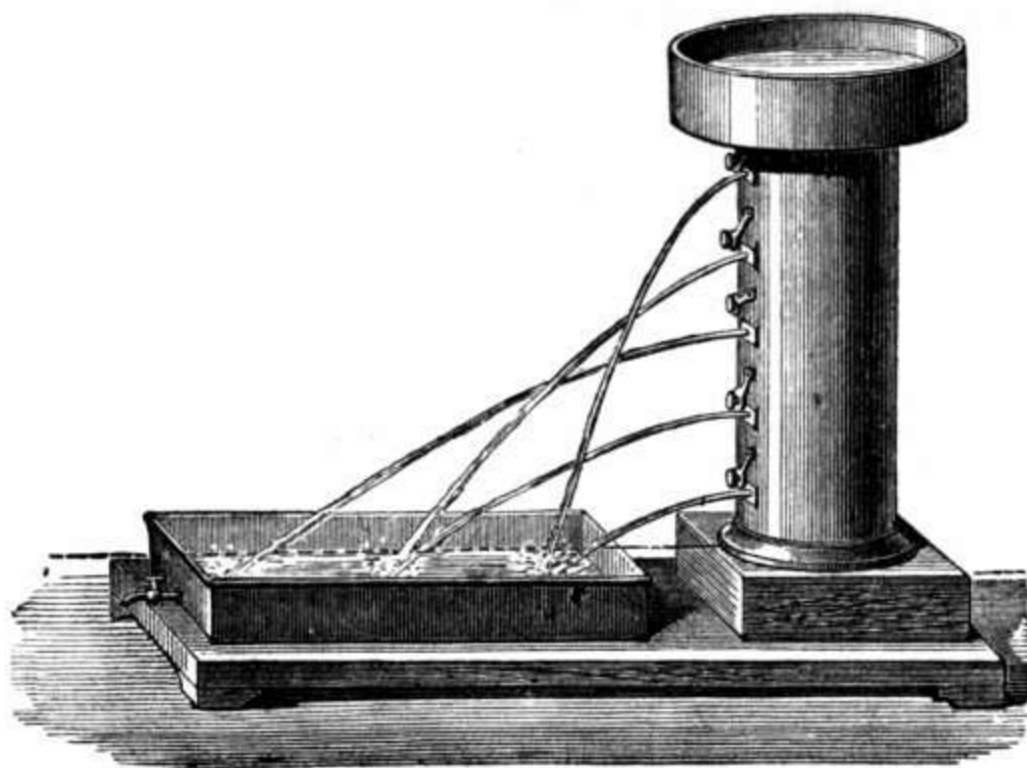

4221.

4220. <b>Vessel for Spouting Fluids.</b> Vertical cistern of tin, neatly japanned, twenty-eight inches high, with five apertures, closed with corks. Mounted on a neat mahogany base.....	7 50
4221. <b>Vessel for Spouting Fluids.</b> Vertical cistern of strong tin, neatly japanned, four inches in diameter, and two feet high, with supply tank on the top; five valves closing the jets at once; jets and valves both of improved form; tin trough with stop-cock, all mounted on a polished mahogany base.....	22 00

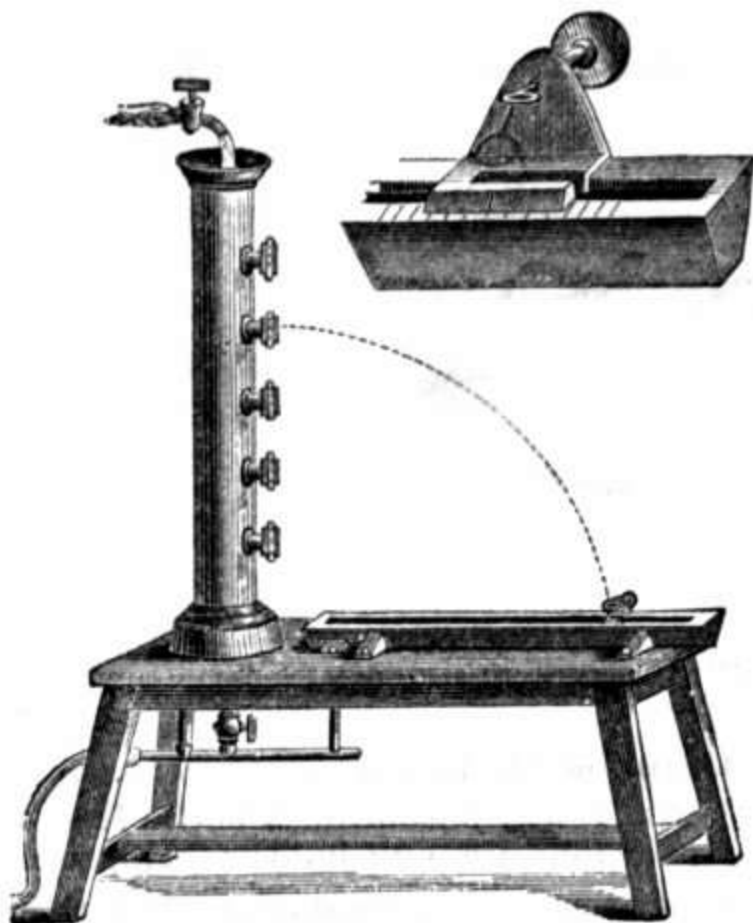

4222.

- |  |              |
|--|--------------|
|  | <b>PRICE</b> |
| 4222. <b>Vessel for Spouting Fluids.</b> Very superior and accurate, consisting of strong brass vertical cistern, three inches in diameter and thirty inches high; valves communicating by a rod, so as to shut or open at once, and can also be used separately if desired. Jets in valves of three kinds, viz.: a thin circular, a tubular, and a conical form; water trough of tin in a wooden frame, bearing a sliding rest with arm and hole to mark the exact point at which the water falls; exit pipe from cistern and trough with stop-cocks and rubber hose; all mounted on a neat, polished mahogany table..... | \$60 00      |

SECTION V.—ON THE APPLICATION OF THE PRINCIPLES OF GRAVITATION TO MACHINERY.

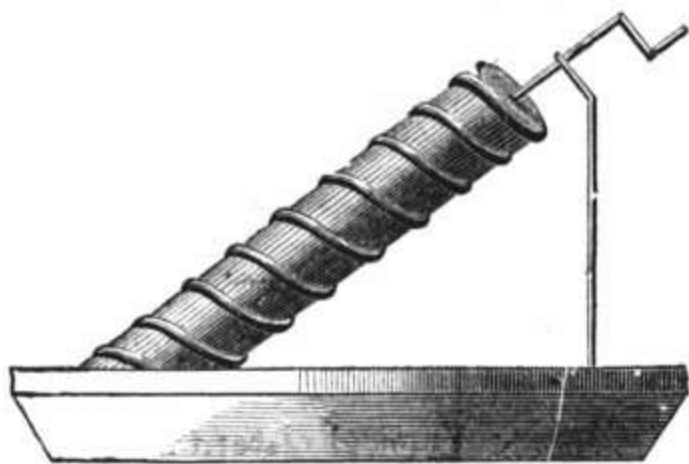

4230.

- |  |       |
|--|-------|
| 4230. <b>Archimedes Pump.</b> Vessel of japanned tin, with screw of lead pipe, on a cylinder of wood twelve inches long.....   | 5 00  |
| 4231. <b>Archimedes Pump.</b> Base of mahogany, cistern of heavy tin, neatly japanned; screw of glass tube, supported on metal rods fifteen inches long. Post of brass ..... | 12 00 |



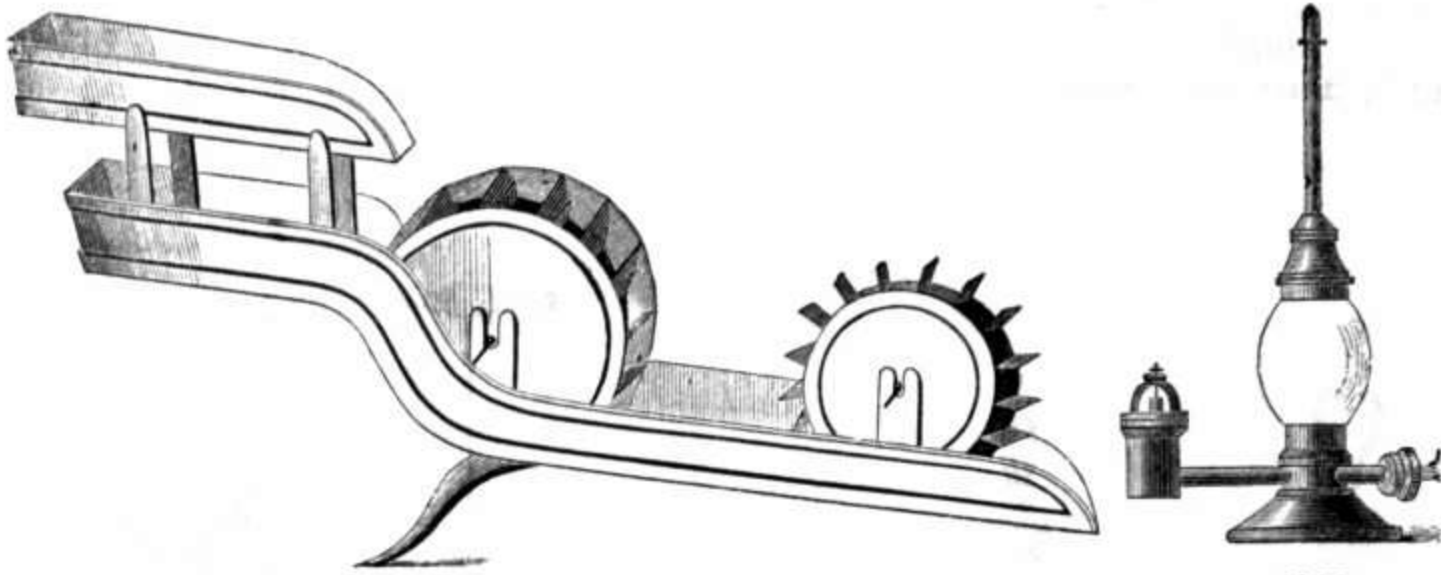

4232.

4233.

- |  | PRICE  |
|--|--------|
| 4232. <b>Model of Water Wheels.</b> Three feet long ; undershot, overshoot, and breast wheel, on same stand. The overshoot serves for breast wheel by reversing. All made of heavy tin neatly japanned . . . . . | \$9 00 |
| 4233. <b>Hydraulic Ram.</b> Small model of brass, with glass chamber and pipe for throwing a vertical fountain.....  | 14 00  |

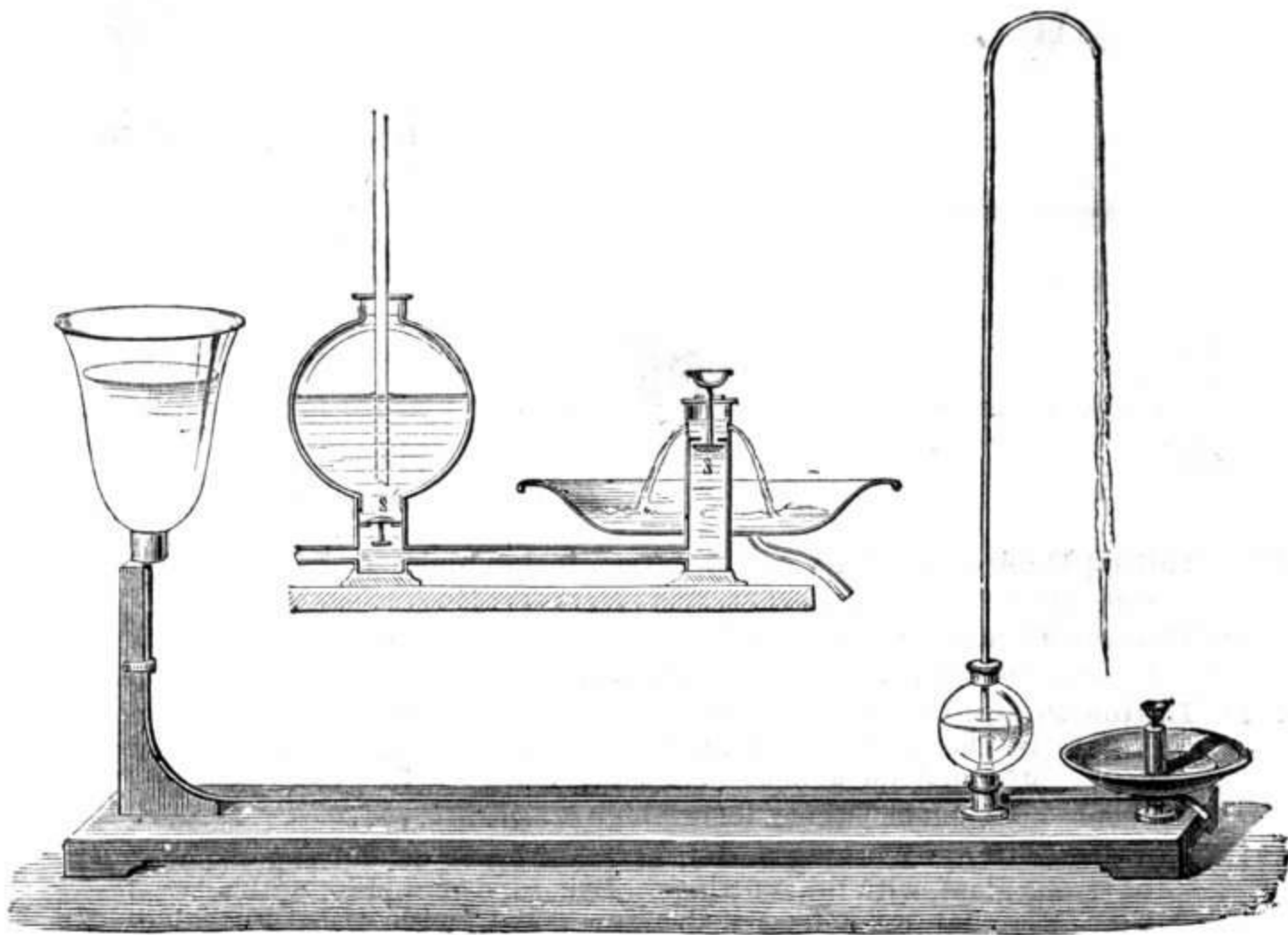

4234.

4234. **Hydraulic Ram.** Reservoir of glass, connected by means of a brass pipe with the ram proper, which has a glass chamber or condenser, and overflow basin, with exit tube and stop-cock. A long vertical tube of glass, bent as shown in the figure, allows the rising of the fluid to be clearly seen. Base of polished mahogany, three and one-half feet long. . . . .
- 25 00

	PRICE
4236. Barker's Mill. Of glass with brass fittings. Twenty-four inches high.....	\$12 00
4237. Turbine Wheel. Small working model, with brass finish and gearings; with basin for outflow.....	12 00

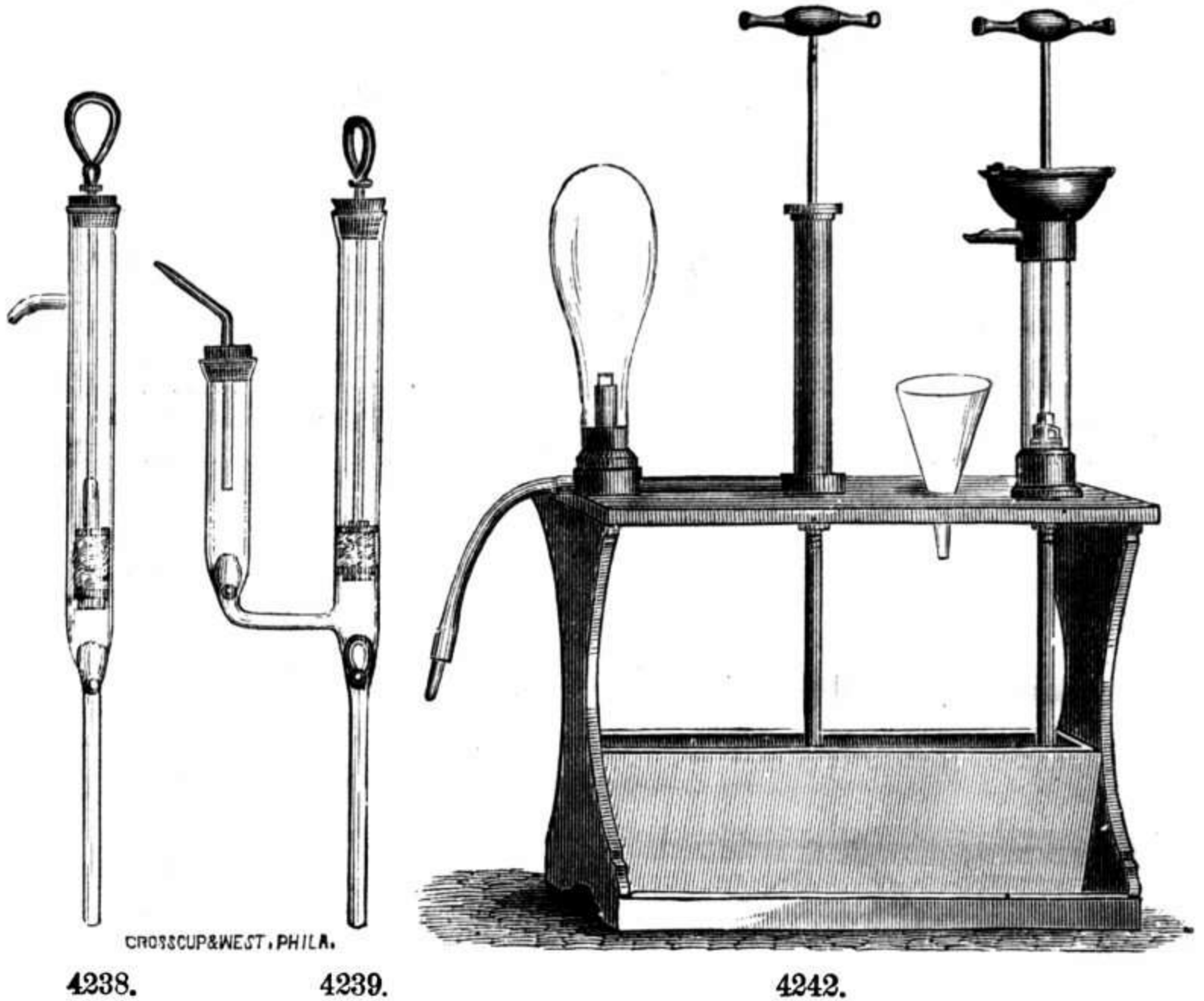

4238. <b>Lifting Pump.</b> Working model, fifteen inches high; all of glass, with conical valves.....	2 00
4239. <b>Forcing Pump.</b> Working model, fifteen inches high; all of glass, with conical valves.....	2 00
4240. <b>Lifting Pump.</b> Working model, barrel of glass, with brass fittings. Valves in the piston, and in the body of the pump, both easily seen. Mounted on a neat mahogany stand, with glass water-jar. Whole instrument twenty inches high.....	10 00
4241. <b>Forcing Pump.</b> Working model, barrel of brass, condensing chamber of strong glass, with brass fittings. Exit-tube of rubber, with a brass tip. Mounted on a neat mahogany stand, with glass water-jar. Whole instrument twenty inches high.....	12 00
4242. <b>Lifting and Forcing Pumps.</b> Nos. 4240 and 4241 on the same stand, of polished mahogany; with water-pan of tin, neatly japanned. ...	16 00

SECTION VI.—THE BAROMETER AND THE AIR-PUMP.



4249.

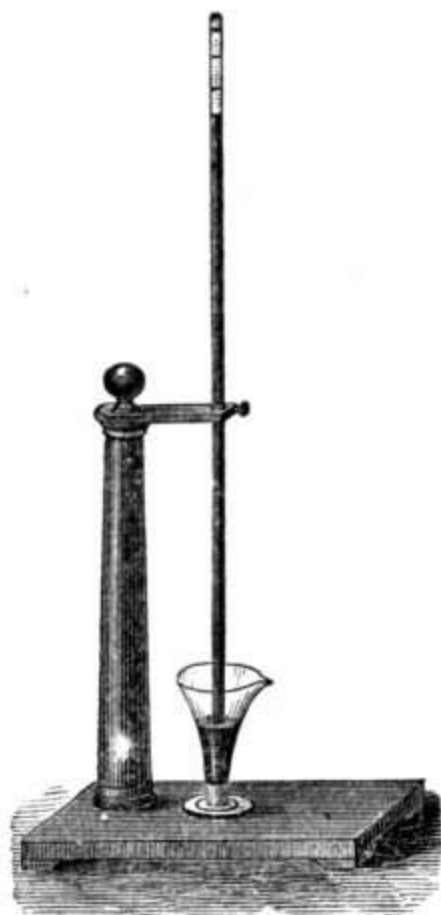

4251.

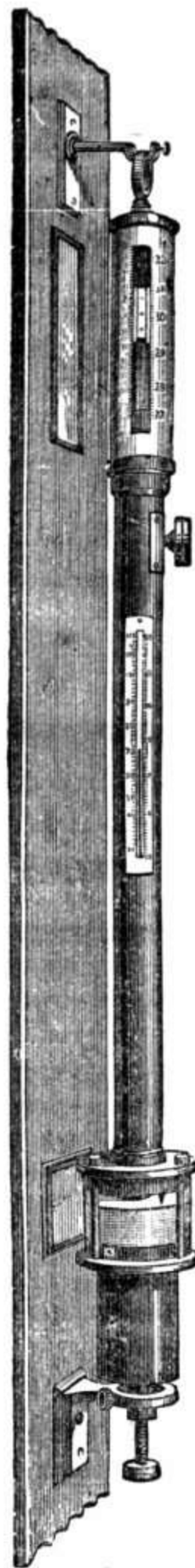

4253.

	PRICE
4249. <b>Barometer Tube.</b> Thirty-five inches long.....	\$0 75
4250. Barometer Tube. Of heavy glass, thirty-five inches long, with glass cup for mercury.....	1 25
4251. Barometer Tube. Same as No. 4250, but with supporting table and pillar of mahogany, and arm of brass to hold the tube.....	5 00
4252. Barometer Tube. Of heavy glass, thirty-five inches long, open at both ends. When used, to have one end closed with sheet rubber.....	75
4253. <b>Normal or Standard Barometer.</b> The construction of this instrument is on that principle known as Fortin's, in which the mercury in the cistern is adjusted at each observation to a fixed ivory point, the zero of the scale. The tube is half an inch in interior diameter. The cistern is made partly of glass, showing the ivory point, or zero, to which the mercury in the cistern is adjusted at each observation by means of the thumb-screw shown at the base of the figure. The vernier reads to the 500th part of an inch, and is adjusted by a rack and pinion. A delicate thermometer is attached in the front of the barometer, and shielded from injury by the brass casing. The whole instrument is finished with brass and mounted upon a solid mahogany frame, as shown in the cut.....	65 00
4254. <b>Standard Smithsonian Barometer Reading</b> to $\frac{1}{100}$ of an inch.....	35 00

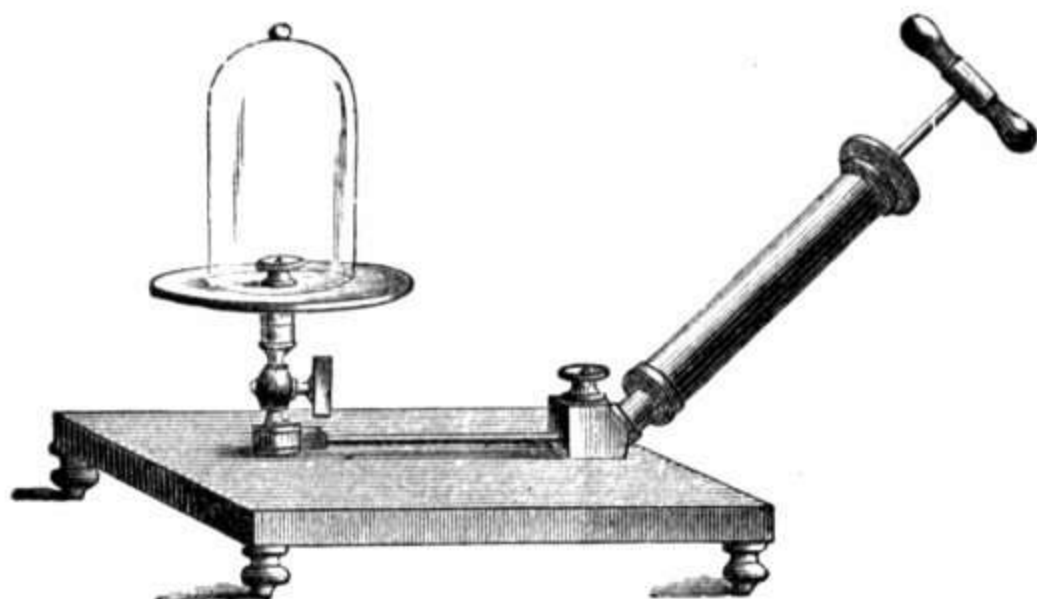

4260.

- |  | PRICE   |
|--|---------|
| 4259. <b>Air-Pump.</b> Barrel of brass, seven inches long by one and a quarter inches in diameter. Plate of brass, six inches in diameter; with guard-screw, and quart bell-glass receiver, No. 4277.....              | \$15 00 |
| 4260. <b>Air-Pump.</b> Barrel of brass, seven inches long by one and a quarter inches in diameter. Plate of brass, eight inches in diameter; with guard-screw, stop-cock, and quart bell-glass receiver, No. 4277..... | 20 00   |

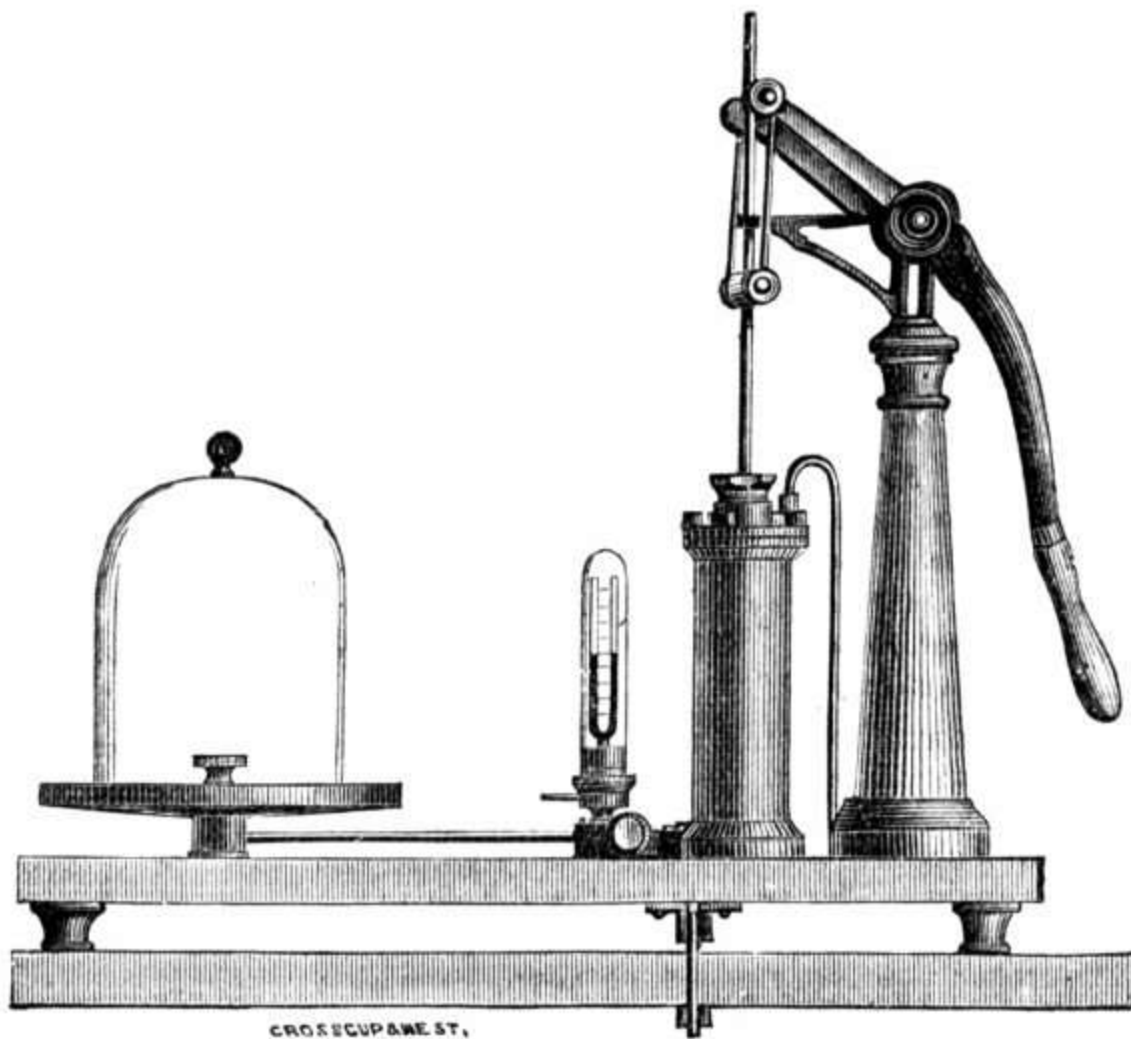

4262.

- |   |       |
|---|-------|
| 4261. <b>Lever Air-Pump.</b> Barrel of brass, seven and a half inches long, and two inches in diameter. Plate of brass, eight inches in diameter; with guard-screw, stop-cock, and half-gallon bell-glass receiver, No. 4278. Base and pillar of polished walnut. Strong iron clamp to fasten the whole instrument securely to a table..... | 40 00 |
| 4262. <b>Lever Air-Pump.</b> Same as No. 4261, but with the addition of a siphon gauge.....   | 45 00 |

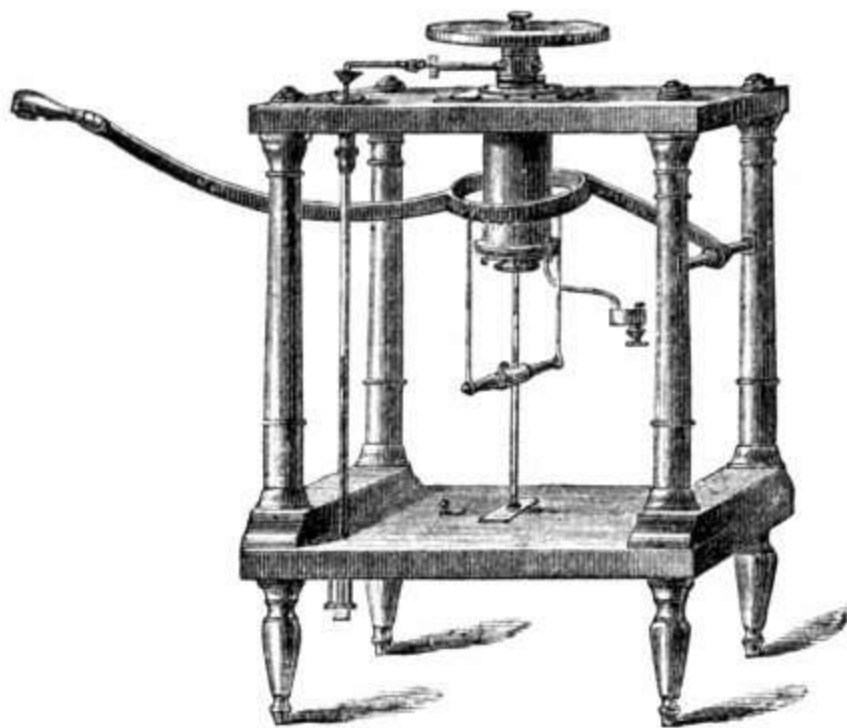

4264.

PRICE

4264. **Lever Air-Pump.** Frame of solid mahogany, finely polished, forty inches high. Barrel of brass, twelve inches long by four inches in diameter. Plate of brass, twelve inches in diameter; with guard-screw, stop-cock, and a two-gallon bell-glass receiver; No. 4280... \$175 00
4265. **Sprengel's Air Pump.** *Improved form.* For complete exhaustion, as in Geissler's and Plucker's tubes.....

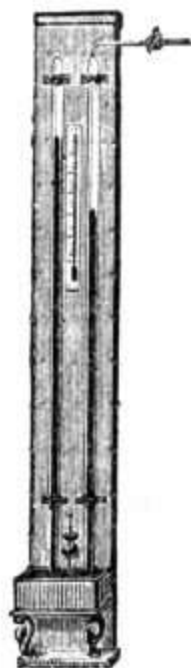

4270.



4272.

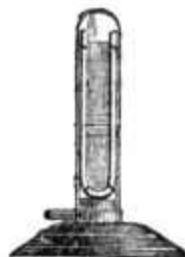

4273.

4270. **Barometric Manometer.** An upright mahogany frame, supporting a cistern of iron and an open and a closed barometer tube. The former is furnished with a stop-cock, and should be connected with the vacuum chamber of the air-pump. The latter is an ordinary barometer tube. By means of this instrument the exact degree of rarefaction can be determined by the comparison afforded by the two barometers..... 15 00
4271. **Barometer Gauge.** Enclosed in a strong glass tube, with brass cap and stop-cock at the upper end to permit the exhaustion of the air from the outer tube, thus allowing the barometer column to fall as the exhaustion proceeds. On a neat mahogany stand..... 25 00

	PRICE
4272. <b>Siphon Gauge.</b> Of glass, six inches long, mounted on a graduated metallic frame, with screw to fit the plate of the air-pump. For use under a receiver. . . . .	\$3 00
4273. <b>Siphon Gauge.</b> Of glass, six inches long, mounted on a graduated brass frame, the whole upon a neat stand, and covered air-tight, with a bell-glass. A pipe at one side permits an attachment to the pump by means of a rubber hose. . . . .	4 00
4275. <b>Detached Pump Plate</b> of brass, twelve inches in diameter, mounted on a solid support of cast iron; with stop-cock and screw connection for rubber hose. . . . .	15 00

BELL-GLASSES.

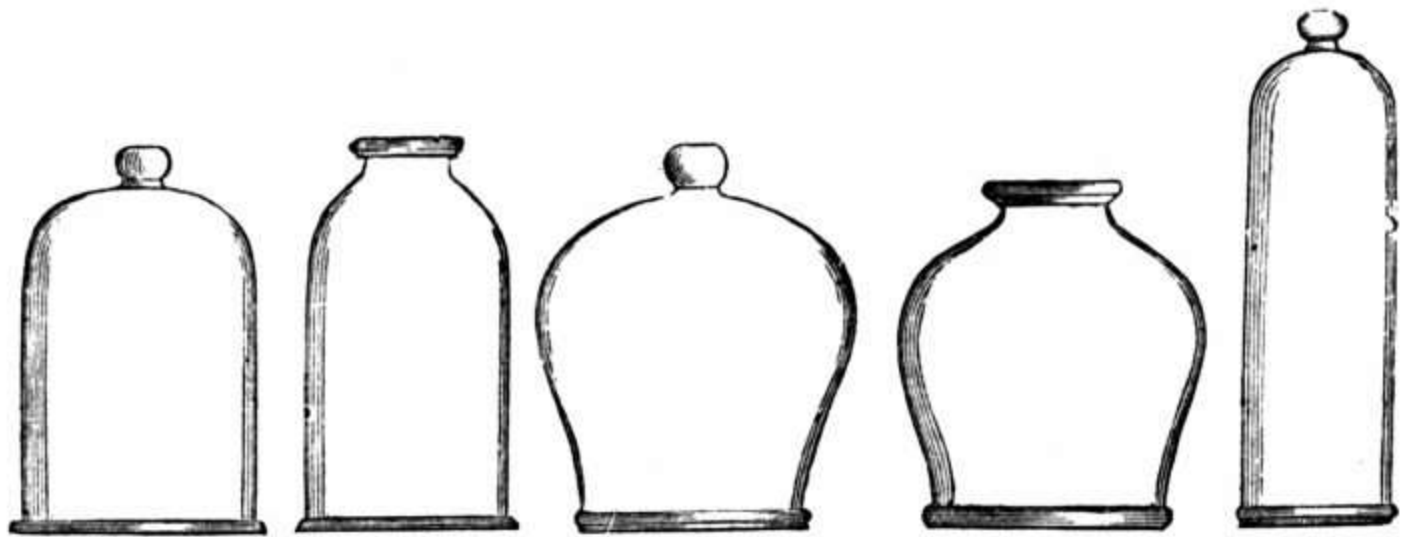

4276-80.      4281-84.      4285-88.      4289-92.      4293 and 4294.

4276. <b>Plain pint bell-glass,</b> with ground flange. . . . .	0 50
4277. <b>Plain quart bell-glass,</b> " " . . . . .	0 75
4278. <b>Plain half-gallon bell-glass,</b> with ground flange. . . . .	1 00
4279. <b>Plain gallon bell-glass,</b> " " . . . . .	1 50
4280. <b>Plain two-gallon bell-glass,</b> " " . . . . .	2 25
4281. <b>Open top, quart, plain bell-glass,</b> " " . . . . .	1 00
4282. <b>Open top, half-gallon, plain bell-glass,</b> " " . . . . .	1 25
4283. <b>Open top, gallon, plain bell-glass,</b> " " . . . . .	2 00
4284. <b>Open top, two-gallon, plain bell-glass,</b> " " . . . . .	3 00
4285. <b>Swelled, quart bell-glass,</b> " " . . . . .	1 00
4286. <b>Swelled, half-gallon bell-glass,</b> " " . . . . .	1 50
4287. <b>Swelled, gallon bell-glass,</b> " " . . . . .	2 25
4288. <b>Swelled, two-gallon bell-glass,</b> " " . . . . .	3 00
4289. <b>Swelled, open top, quart bell-glass,</b> " " . . . . .	1 00
4290. <b>Swelled, open top, half-gallon bell-glass,</b> " " . . . . .	1 75
4291. <b>Swelled, open top, gallon bell-glass,</b> " " . . . . .	2 50
4292. <b>Swelled, open top, two-gallon bell-glass,</b> " " . . . . .	3 00
4293. <b>Plain bell-glass,</b> six inches in diameter and fifteen inches high, with ground flange. . . . .	3 00
4294. <b>Plain bell-glass,</b> six inches in diameter and thirty-four inches high, with ground flange. . . . .	8 00
4295. <b>Ground-glass cover,</b> four inches in diameter, for any of the open top bell-glasses . . . . .	80
4295½. <b>Tubulated Receiver.</b> One-half gallon . . . . .	1 25
4295¾. <b>Tubulated Receiver.</b> One gallon. . . . .	2 00

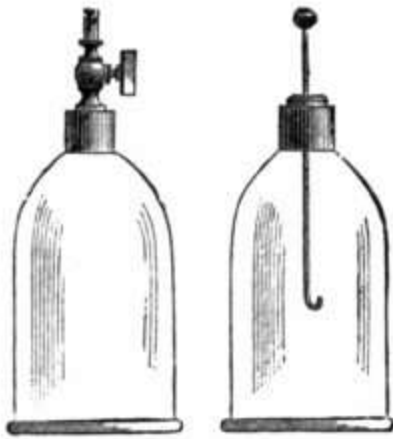

4296.

4297.

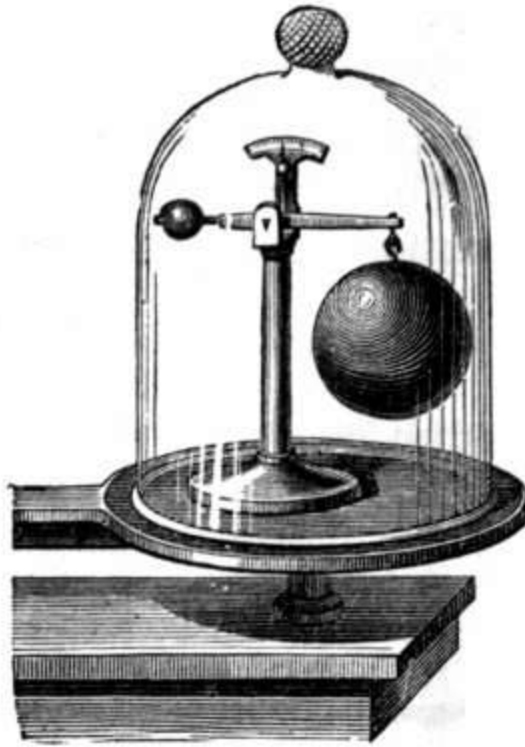

4298.

	PRICE
4296. Plain gallon bell-glass, with brass cap and stop-cock.....	\$3 50
4297. Plain gallon bell-glass, with brass sliding rod, hook and ball.....	4 50
4298. Hollow Copper Globe. Three inches in diameter, with stop-cock and scale-beam for suspension under receiver, with box and weights. Without the receiver.....	9 00
4299. Hollow Copper Globe. For weighing air, 7 inches in diameter, with stop-cock and hook.....	5 50
4300. Cork Globe. Three inches in diameter, with scale-beam and counterpoise.....	5 50
4301. Accurate Balance. For weighing air, and for specific gravity purposes. Beam of brass, sixteen and a half inches long, scale pans and beam both moving on knife-edges, and supporting post permitting a vertical adjustment.....	16 00



4310.



4311.



4312-4316.

4310. Hand Glass.....	1 00
4311. Bladder Glass.....	1 00
4312. Magdeburg Hemispheres. Of brass, three inches in diameter, on stand of iron, neatly japanned.....	6 00
4313. Magdeburg Hemispheres. Same as No. 4312, but three and a half inches in diameter.....	7 00
4314. Magdeburg Hemispheres. Same as No. 4312, but four inches in diameter.....	8 00
4315. Magdeburg Hemispheres. Of cast iron, four inches in diameter, on iron stand. All neatly japanned.....	5 50
4316. Magdeburg Hemispheres. Same as No. 4315, but five inches in diameter.....	6 50

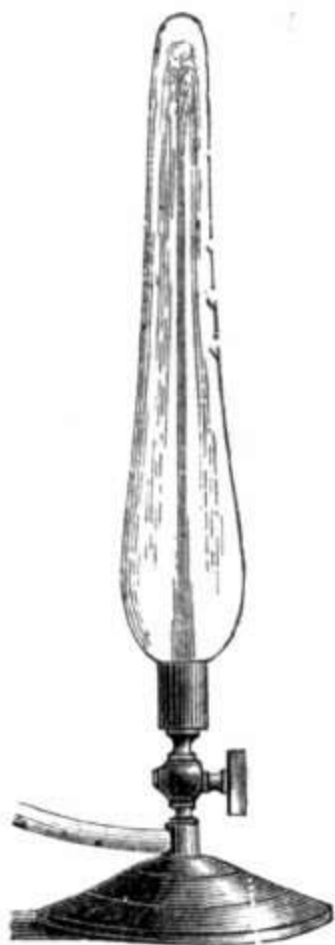

4320 and 4321.

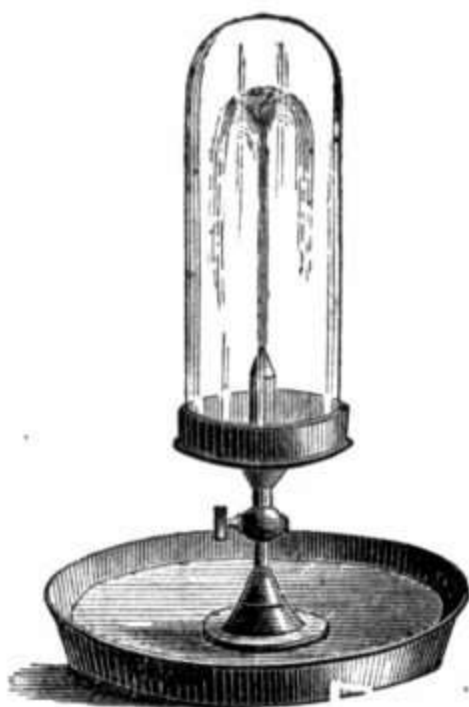

4322 and 4323.



4324.

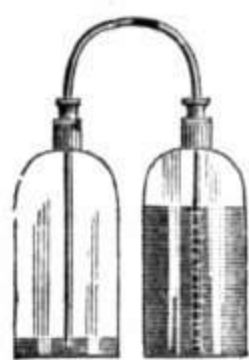

4325.

PRICE

- |  |        |
|--|--------|
| 4320. Fountain in Vacuo. Glass bell, twenty inches high, with brass fitting and stop-cock, on a neatly japanned iron base..... | \$5 00 |
| 4321. Fountain in Vacuo. Same as No. 4320, but with glass bell, twenty-six inches high.....                                    | 6 50   |

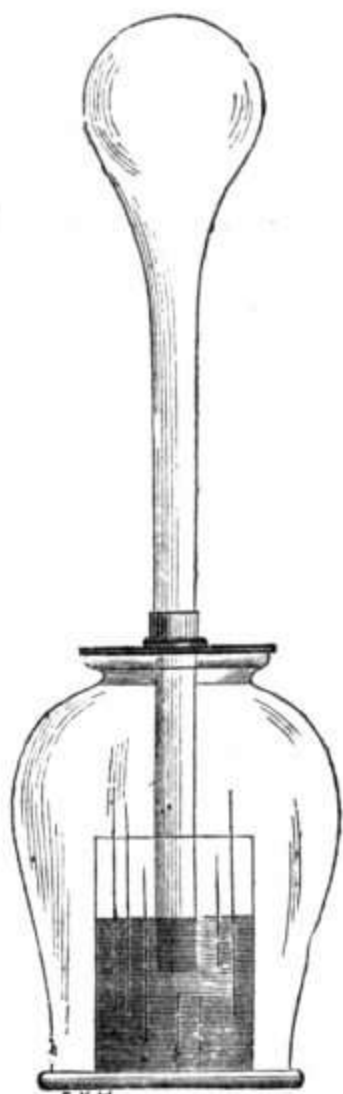

4331

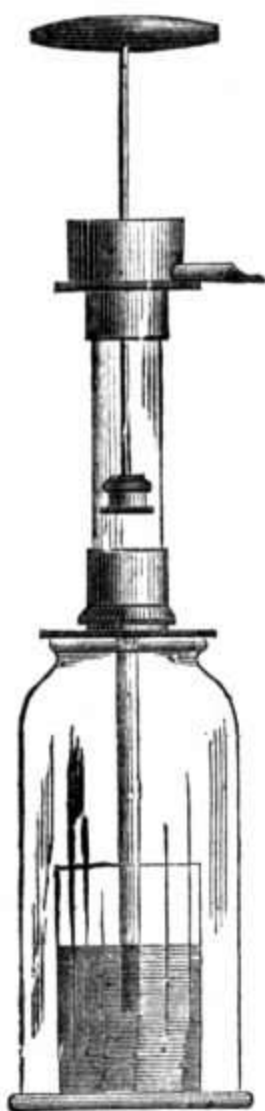

4333.



4335.

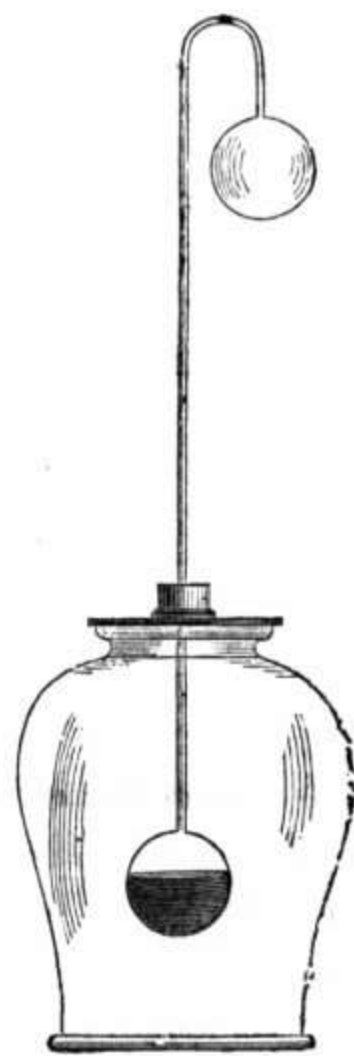

4337.



4322. <b>Fountain in Vacuo.</b> French form, in which the base is ground to fit the pump plate, glass bell, brass cap, stop-cock, and base, and water cistern of japanned tin.....	\$12 00
4323. <b>Fountain in Vacuo.</b> Same as No. 4322, but with glass bell, 30 inches high.....	15 00
4324. <b>Expansion Fountain.</b> Twelve inches high.....	3 50
4325. <b>Bacchus Illustration.</b> Glass vessels seven inches high, with brass fittings..	2 25
4330. <b>Bolt Head.</b> Thirty inches long, with brass cap for receiver, without receiver or glass cell.....	3 00
4331. <b>Bolt Head,</b> same as No. 4330, but with receiver No. 4291, and glass cell as shown in cut.....	6 00
4332. <b>Water Pump in Vacuo.</b> Glass working model with brass mountings, and ground brass cap for receiver, without receiver or glass cell....	6 50
4333. <b>Water Pump in Vacuo.</b> Same as No. 4332, but with receiver, No. 4283, and glass cell, complete.....	8 50
4334. <b>Barometer Tube in Vacuo.</b> Strong barometer tube, with ground brass flange for receiver, without receiver or glass cell.....	4 50
4335. <b>Barometer Tube in Vacuo.</b> Same as No. 4334, but with receiver No. 4283, and glass cell complete.....	6 50
4336. <b>Cryophorus in Vacuo.</b> With ground brass flange for receiver, without receiver.....	4 50
4337. <b>Cryophorus in Vacuo.</b> Same as No. 4336, but with receiver No. 4291.....	7 00



4340.



4341.

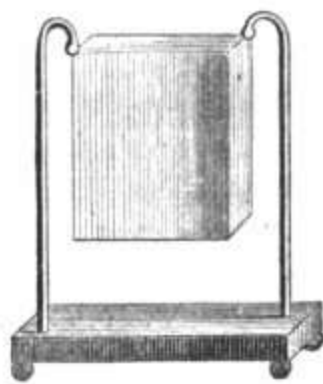

4342.



4343 and 4344.



4350.

4340. <b>Bell for Vacuum.</b> Support of brass. Cords of silk.....	2 50
4341. <b>Bell for Vacuum.</b> Spring bell, neatly silvered, resting on a support of rubber.....	2 50
4342. <b>Bell for Vacuum.</b> Furnished with clock movement for striking the bell, and thoroughly insulated by cords of silk and base of rubber, so as to convey the least possible sound to the pump plate.....	12 00
4343. <b>Freezing Apparatus.</b> Glass dish six inches in diameter, wire support for watch glass, and shallow receiver to suit.....	2 50
4344. <b>Freezing Apparatus.</b> Similar to No. 4343, but with eight-inch dish and receiver.....	3 00
4350. <b>Apparatus for firing Powder in a Vacuum.</b> Brass funnel, drop stop-cock, and ground brass flange four inches in diameter.....	6 00

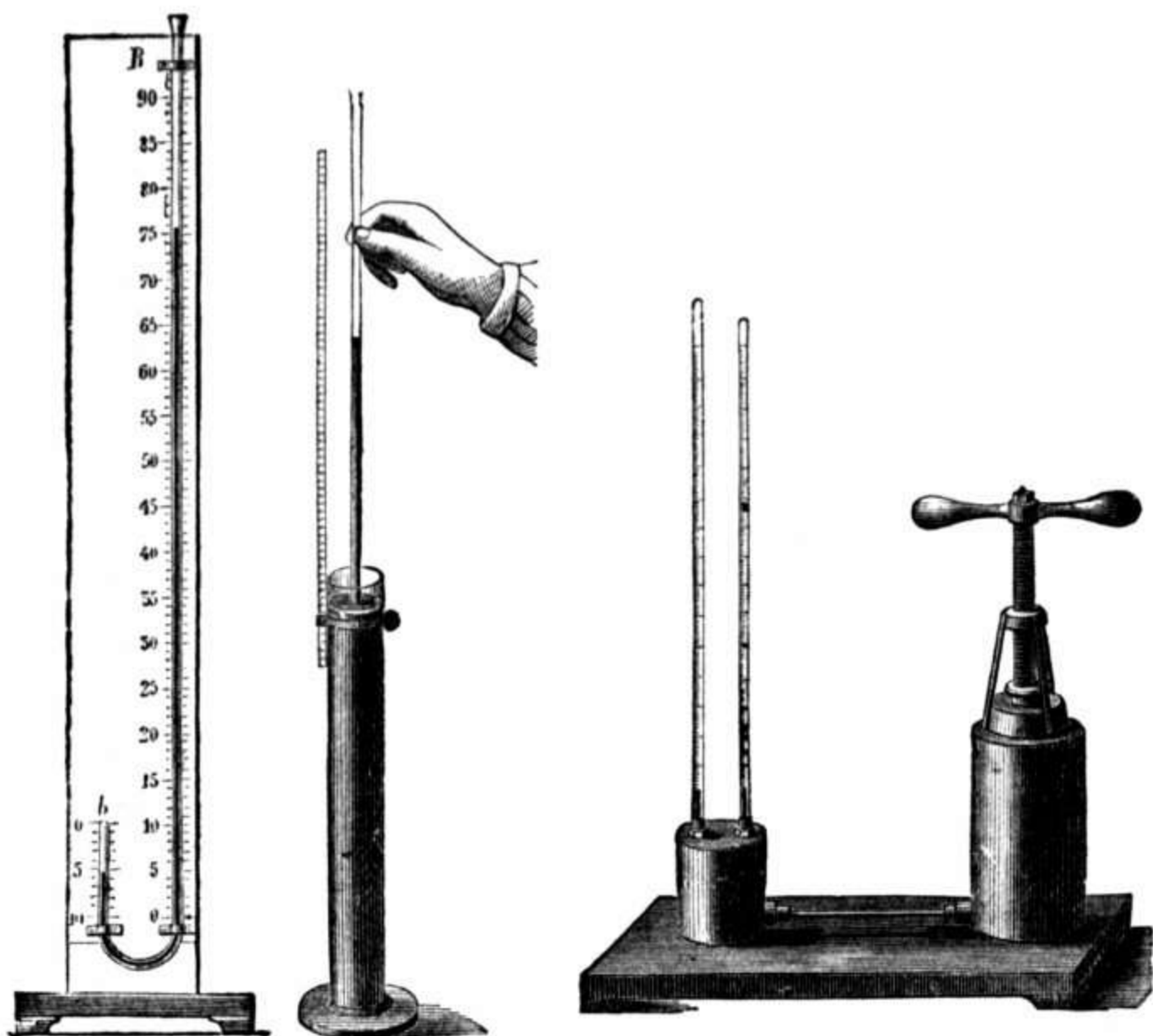

4351.

4353.

4354.

	PRICE
4351. <b>Mariotte's Law Apparatus.</b> Tube of glass on upright frame of mahogany, well polished. Funnel of brass. Whole instrument forty inches high. Scale for both arms . . . . .	\$9 00
4352. <b>Mariotte's Law Apparatus.</b> For pressures up to three atmospheres. Tubes of glass, in sections, with brass screw connectors. Neat mahogany frame, with scales for both arms. . . . .	15 00
4353. <b>Mariotte's Law Apparatus.</b> For pressures less than one atmosphere. Tank of glass, with scale, clamp, and strong barometer tube. . . . .	6 00
4354. <b>Apparatus to show the Comparative Compressibility of Different Gases.</b> Two strong barometer tubes in an iron cistern, and a chamber in which a strong pressure can be applied by a screw. On a polished mahogany base. . . . .	50 00
4355. <b>Guinea and Feather Tube.</b> Fitted also with point and ball for use as an <i>aurora</i> tube, with stop-cock, and strong cast-iron base. Tube three feet long. . . . .	7 00
4356. <b>Guinea and Feather Tube.</b> Similar to No. 4355, but four feet long. .	8 00
4357. <b>Guinea and Feather Tube.</b> Similar to No. 4356, but larger diameter	10 00

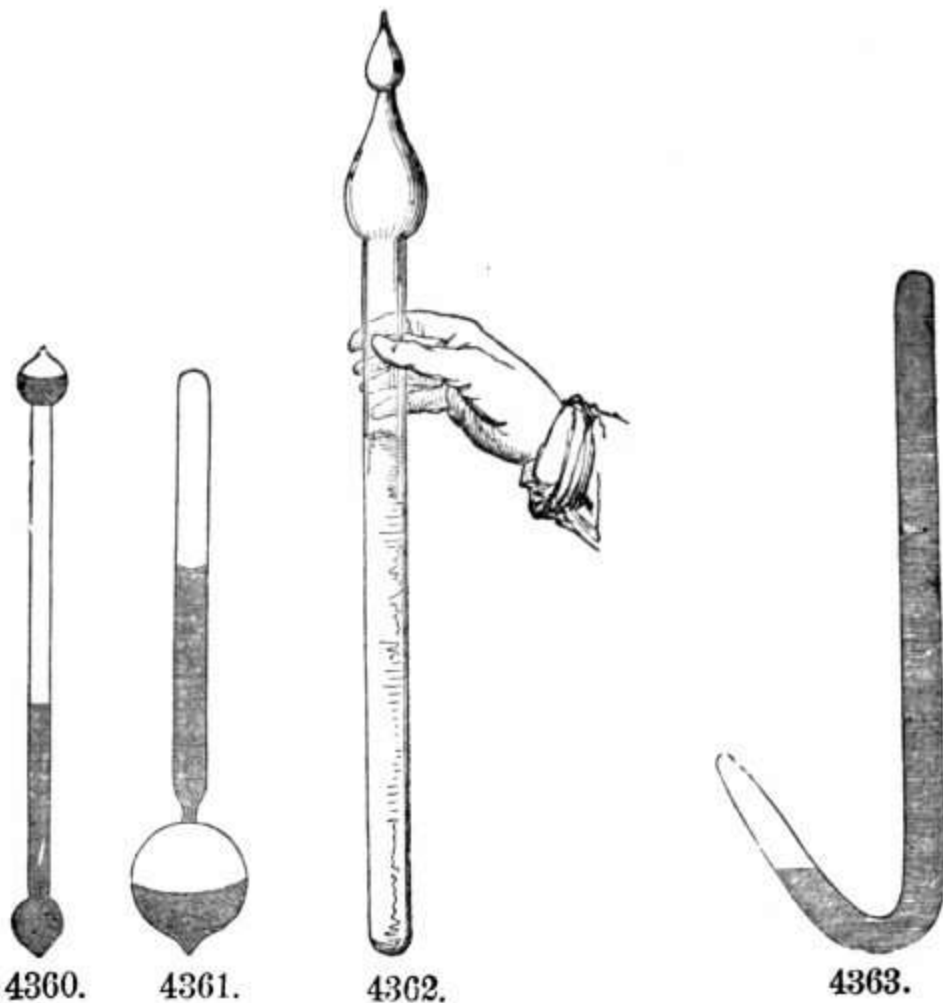

	PRICE
4360. <b>Water Hammer.</b> Straight form, nine inches long, with bulb on each end.....	\$1 00
4361. <b>Water Hammer.</b> Straight form, nine inches long, with bulb on one end.....	1 00
4362. <b>Water Hammer.</b> Straight form, fifteen inches in length, with bulb on one end.....	2 00
4363. <b>Water Hammer.</b> Bent form, twelve inches long, on vertical part of tube.....	2 00

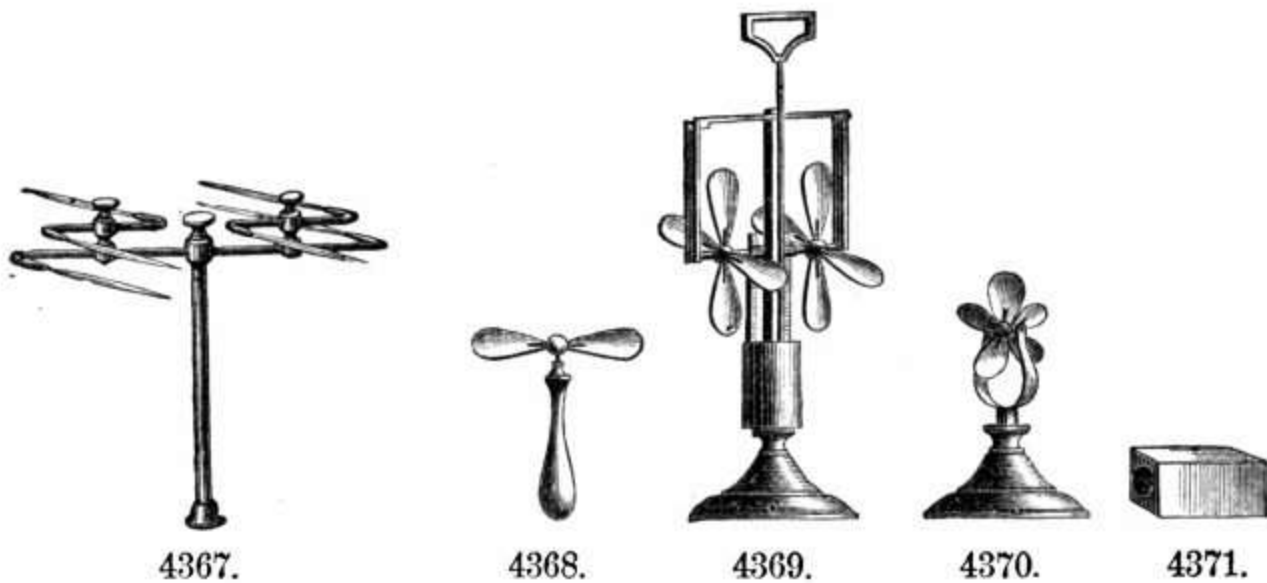

4366. <b>Single Revolving Jet.</b> Of brass, on stand.....	2 50
4367. <b>Triple Revolving Jet.</b> .....	4 00
4368. <b>Wind Mill.</b> To be used with the hand.....	1 00
4369. <b>Air Mill.</b> In which the fans are set in motion by a heavy weight, and a rack and pinion of brass.....	10 00
4370. <b>Resistance Fans.</b> Of brass, on an iron base.....	2 00
4371. <b>Block of Wood.</b> Loaded, to show porosity.....	50

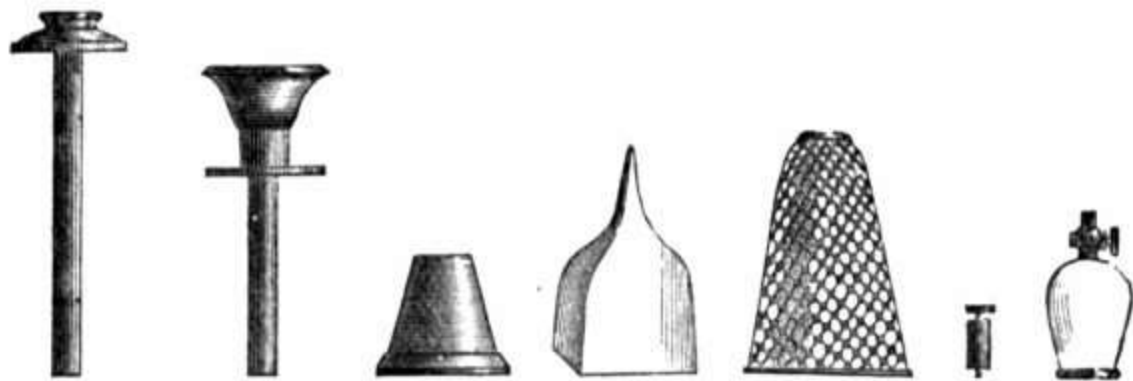

4372. 4373. 4374. 4380. 4381. 4382. 4383.

	PRICE
4372. <b>Air Shower.</b> A wooden cylinder, with a flange four inches in diameter, covered with sheet rubber.....	\$1 25
4373. <b>Mercury Funnel.</b> Brass flange, four inches in diameter, with wooden cup and cylinder.....	1 75
4374. <b>Apple Cutter.</b> Of brass, four inches in diameter .....	3 00
4380. <b>Bursting Squares of thin Glass,</b> three inches square. Per dozen...	2 25
4381. <b>Wire Guard</b> for No. 4380.....	75
4382. <b>Valve Cap</b> for No. 4380.....	50
4383. <b>Cupping Glass.</b> Glass about two inches in diameter, with small stopcock.....	3 00
4384. <b>Rubber Bag,</b> six inches in diameter; to be placed under a receiver to show the expansion of air.....	1 75

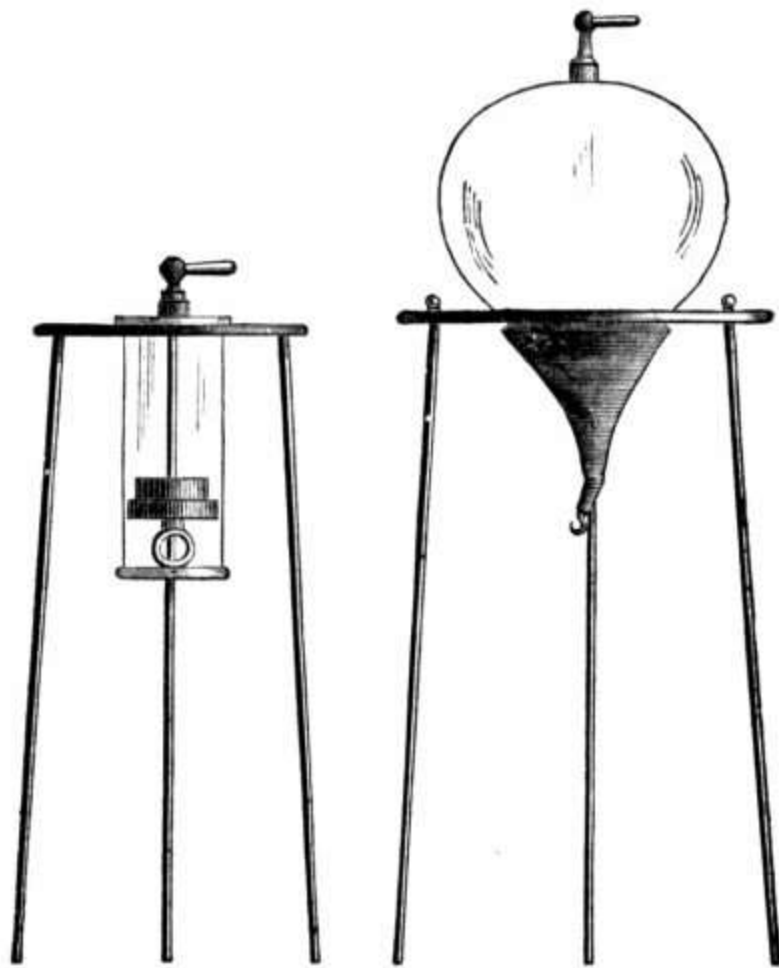

4385.

4386.

4385. <b>Upward Pressure Apparatus.</b> Strong brass cylinder, with piston, brass flange, and connector for rubber hose. Supported on a stout mahogany table, with iron legs. Without weights.....	10 00
4386. <b>Upward Pressure Apparatus.</b> Strong globular glass vessel, with brass cap and pipe at top, and stout rim, unground, below. To the latter is attached a strong rubber bag, with hook. The whole is supported upon a strong mahogany table, with iron legs. Without weights.....	13 00

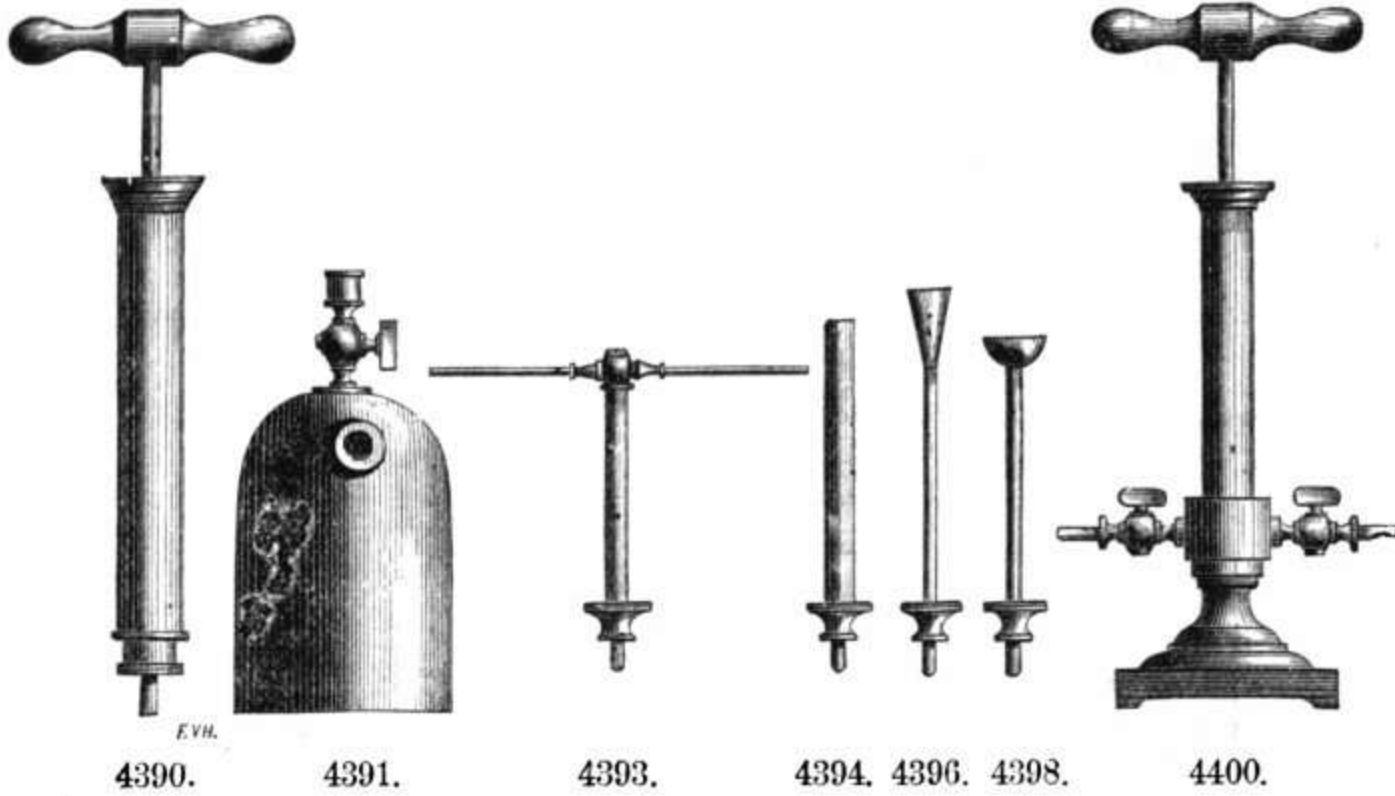

	PRICE
4390. <b>Condensing Syringe.</b> Convertible by reversing the valves into an exhausting syringe. Barrel of brass, eight inches long, and one and one-quarter inches in diameter.....	\$7 50
4391. <b>Copper Reservoir.</b> For compressed air, with two stop-cocks, to one of which is fastened a metal pipe reaching nearly to the bottom of the reservoir.....	7 50
4392. <b>Glass Reservoir.</b> For compressed air, with brass screw fittings and stop-cock.....	15 00
4393. <b>Revolving Jet.</b> Of brass, with arm seven inches in length.....	2 50
4394. <b>Air-Gun Jet.</b> Of brass, six inches long.....	1 00
4395. <b>Ball Paradox.</b> Of glass, seven inches long.....	75
4396. <b>Ball Paradox.</b> Of brass, six inches long.....	1 50
4397. <b>Plate Paradox.</b> Of brass, with mica discs.....	1 50
4398. <b>Fountain Jet.</b> Of brass, six inches long.....	2 00
4399. <b>Condensing Apparatus Complete.</b> Consisting of Nos. 4390, 4391, 4393, 4394, 4396, 4397 and 4398.....	23 50
4400. <b>Transferrer.</b> Pump of brass, eight inches long by one and one-quarter inches in diameter, mounted on a strong iron base, with entrance and exit stop-cocks.....	14 00
4401. <b>Brass Plate and Sliding Rod, with Hook.</b> .....	4 00
4402. <b>Bladder and Weight, small model</b> .....	5 00
4403. <b>Gold Beater's Skin Balloons</b> .....	2 25



4401

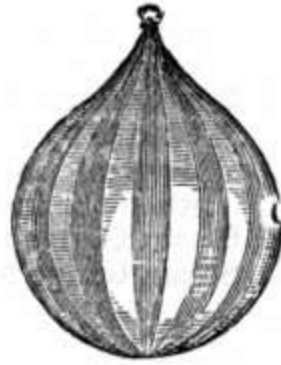

4403

## SECTION VII.—MANOMETERS.

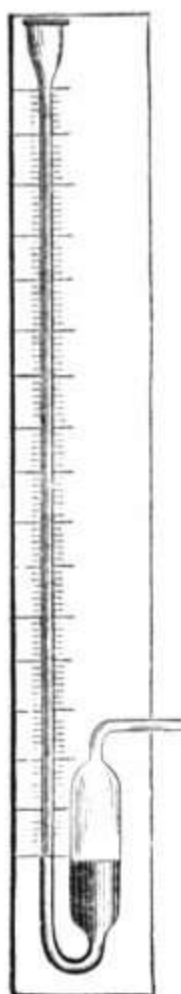

4425.

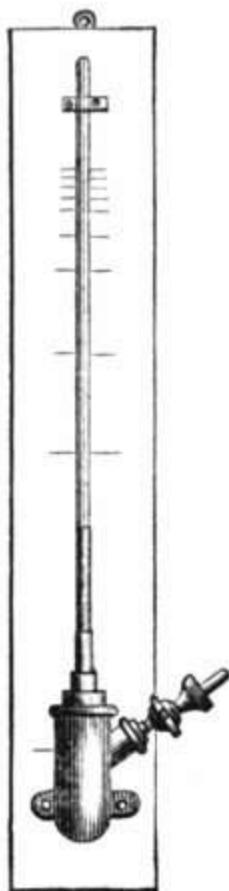

4426.

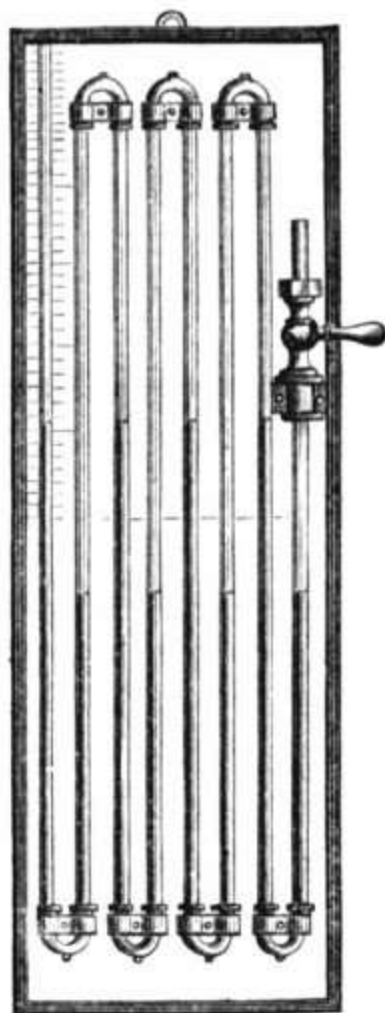

4427.

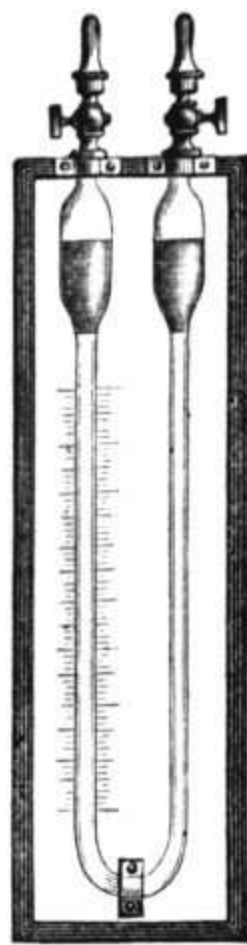

4428.

	PRICE
4425. <b>Open Manometer Tube.</b> To measure pressures less than one atmosphere. An upright tube of glass, thirty-six inches high, connected at the base, through a curved arm, with a strong glass reservoir for mercury, to the top of which the pressure is applied. On a neat mahogany frame, with scale.....	\$8 00
4426. <b>Closed Manometer Tube.</b> For pressures higher than one atmosphere. A strong iron cistern fitted with a closed vertical glass tube, and a side stop-cock. Mounted on a neat mahogany frame, thirty inches high, with scale.....	12 00
4427. <b>Compound Open Manometer.</b> Four pairs of tubes, connected by metal joints at top and bottom; the upper half of each tube is to be filled with water, the lower half with mercury. The last tube is of glass, and carries a scale showing the pressure. On a neat mahogany frame, forty inches high.....	20 00
4428. <b>Differential Manometer.</b> To register very small differences in pressure. Consists of a bent glass tube, placed upright and having a cylindrical bulb and a stop-cock on each arm. One bulb and both tubes, as far as zero of the scale, are filled with a mixture of alcohol and water. The other bulb and the remaining part of the corresponding tube are filled with a colored oil, of exactly the same specific gravity as the former mixture. A very slight difference in pressure is thus strikingly shown. Mounted on a neat mahogany frame, twenty-four inches high. Without liquids.....	9 00
4429. <b>Comparative Manometer.</b> Consisting of two open manometers, placed side by side, with a common scale, and brass fittings and connectors. Mounted in a neatly polished walnut box, which closes when the instrument is not in use.....	12 00
4430. <b>Steam Gauge</b> for pressures up to 180 pounds to the inch.....	18 00
4431. <b>Steam Gauge</b> for pressures up to 250 pounds to the inch.....	22 50

## SECTION VII.—AIR-PUMP ACCESSORIES.

	PRICE
4440. <b>Rubber Hose for Connectors.</b> Strong enough not to collapse in exhausting, per foot.....	\$0 20
4441. <b>Rubber Hose for connections,</b> with cloth lining, <i>not elastic</i> , per foot.	25
4442. <b>Screw Couplings,</b> to connect hose with stop-cocks without twisting the hose, each.....	1 00
4443. <b>Stop-Cock of brass,</b> with outside screw on each end.....	1 50
4444. <b>Stop-Cock of brass,</b> with outside screw on one end and inside on the other.....	1 50
4445. <b>Stop-Cock of brass,</b> with inside screw on each end.....	1 50
4446. <b>Stop-Cock of brass,</b> with outside screw on each end, and with an additional small <i>inside</i> screw in one end.....	2 00
4447. <b>Small Stop-Cock of brass,</b> with outside screw on each end to fit the inside screw of No. 4446.....	1 25
4448. <b>Stop-Cock of iron,</b> for use with mercury, with outside screw on each end.....	3 00
4449. <b>Stop-Cock of iron,</b> with outside screw on one end and inside screw on the other.....	3 00
4450. <b>Brass Coupler,</b> with outside screws.....	50
4451. <b>Brass Coupler,</b> with inside screws.....	50
4452. <b>Brass Coupler,</b> with one inside and one outside screw.....	50
These couplers, Nos. 4450-52, fit the stop-cocks, Nos. 4443-46, and also any of the stop-cocks used with any of our pneumatic apparatus, as the thread is <i>uniform</i> throughout.	
4453. <b>Guard Screw,</b> for pump-plate.....	50
4454. <b>Bottle of Oil,</b> for pump.....	50
4455. <b>Leather Washers,</b> assorted, per hundred.....	50
4456. <b>Sheet rubber,</b> pure, very thin, per square foot.....	50
4457. <b>Sheet rubber,</b> pure, heavier than No. 4456, per square foot.....	50

## CHAPTER IV.

## UNDULATIONS.

4474. <b>Spiral</b> of elastic brass wire to show wave motion.....	2 50
4475. <b>White Silk Cord,</b> very soft and pliable, to show the waves in cords, by fastening one end to a firm support, and starting the wave by the hand from the other.....	2 00
4476. <b>String of Silvered Beads,</b> twelve feet long, for the same purpose....	5 00
4477. <b>Melde's Apparatus.</b> A tuning-fork on stand, with a hook, cord and support.....	18 00
4478. <b>Melde's Apparatus.</b> Tuning-fork, three feet high, with hook, and white silk cord twelve feet long. On a heavy base.....	30 00
4479. <b>Melde's Apparatus.</b> Same as No. 4478, but with a magnetic interrupter, to keep up the vibrations.....	45 00

	PRICE
4482. <b>Circular Vase</b> , with spring and points to produce waves in fluids. . . .	\$6 00
4483. <b>Elliptical Vase</b> , to show the waves by reflection from a body of mercury. . . . .	2 50
4484. <b>Rectangular Vase</b> , for the same purpose. . . . .	2 50
4485. <b>Grand Rectangular Vase</b> , with bottom of glass, and with mirror to reflect the waves upon a screen. Lighted from below by the hydro-oxygen light. Mounted on neat table. . . . .	40 00
4486. <b>Weber's Wave Canal</b> . A trough with glass sides, to show waves in water, by skilfully raising and depressing one end . . . . .	25 00
4487. <b>Rood's Wave Apparatus</b> . To show by projection that in the progressive motion of the wave the individual particles composing it do not themselves partake of the forward movement. . . . .	5 50
4488. <b>Wave Apparatus for projection</b> . Similar purpose as No. 4487, but arranged so as to be kept in action any required time. . . . .	25 00
4489. <b>Wave Apparatus</b> , for projection. To show the reflection of a wave. .	25 00
4490. <b>Dickerson's Wave Apparatus</b> , for projection. To show the propagation of a sound wave from a centre (sounding body) outward. Six rays show the arrangement of the particles of air as the wave progresses. . . . .	10 00
4491. <b>Wave Apparatus, for projection</b> . To show the arrangement of the air particles in a sounding organ-tube. One node . . . . .	25 00
4492. <b>Wave Apparatus, for projection</b> . Showing the vibrations of the ether in light waves. . . . .	25 00
4493. <b>Wave Apparatus, for projection</b> . Showing the interference of two vibrating movements. . . . .	25 00
4494. <b>Whole Series of Wave Apparatus</b> , consisting of seven plates, with a common stand for them all, instead of a separate stand for each . . . . .	60 00
4505. <b>Apparatus</b> to represent the molecular movement of an aerial wave produced by a simple shock. . . . .	k 7 50
4506. <b>Apparatus</b> to represent the molecular movement of aerial waves, produced by a continuous sound. . . . .	k 7 50
4507. <b>Apparatus</b> to represent the molecular movement of aerial waves confined in tubes. . . . .	k 9 50
4508. <b>Apparatus</b> to represent the molecular movements of liquid waves . . .	k 18 00
4509. <b>Apparatus</b> to represent the molecular movement of waves of ether. . .	k 15 00
4510. <b>Wheatstone's Wave Apparatus</b> , to show the theoretical curves resulting from the co-existence of two systems of simple waves in the same plane; of two systems of waves perpendicular to each other; of one system of plane waves with another circular or elliptic; and finally, of two circular or elliptic systems. . . . .	k 112 00
4511. <b>Wheatstone's Wave Apparatus</b> . Similar to No. 4510, but without the resultants of the two circular or elliptic systems. . . . .	k 56 00
4512. <b>Apparatus</b> , showing the theoretical curves resulting from the co-existence of two systems of simple waves in the same plane. . . . .	k 20 00
4513. <b>Apparatus</b> , showing the theoretical curves resulting from the co-existence of two systems of equal and perpendicular waves. . . . .	k 10 00
4514. <b>Wheatstone's Apparatus</b> for the combination of two rectangular vibrations. . . . .	k 30 00



## CHAPTER V.

## ACOUSTICS.

## SECTION I.

*Apparatus for the Production of Sound in General.*

	PRICE
4530. <b>Eight pieces of wood</b> , giving the gamut when struck in succession..	\$1 50
4531. <b>Four pieces of wood</b> , giving the chord.....	1 00
4532. <b>Water Hammer</b> .....	1 00
4533. <b>Four tubes</b> , with pistons, giving the chord when their pistons are successively drawn.....	12 00
4534. <b>Heavy or Bass Bow</b> .....	3 00
4535. <b>Violin Bow</b> .....	2 00
4536. <b>Bow</b> for vibrating plates by the middle.....	4 00
4537. <b>Whistling tube</b> of Cagniard de Latour.....	1 25
4538. <b>Philosopher's Lamp</b> .....	3 00
4539. <b>Steam Whistle</b> of brass.....	6 00
4540. <b>Universal Mouth-piece</b> .....	3 50
4541. <b>Mouth-piece</b> of Tube, with movable lever.....	3 50
4542. <b>Mouth-piece</b> of the Cornet.....	1 50
4543. <b>Mouth-piece</b> of the Trumpet.....	1 50
4544. <b>Mouth-piece</b> of the Clarionet.....	2 00
4545. <b>Mouth-piece</b> of the Hautbois.....	1 50
4546. <b>Mouth-piece</b> of the Bassoon.....	1 50
4547. <b>Siren of Cagniard de Latour</b> , with cylindrical tube.....	k 3 50
4648. <b>Trevelyan Rocker</b> .....	4 00
4549. <b>Wertheim's Apparatus</b> .....	9 50
4550. <b>Magnetic Interrupter</b> , in which the vibrating spring is replaced by a diapason, $ut_2$ .....	k 26 50
4551. <b>Magnetic Interrupter</b> , with three diapasons, $ut_{-1}$ , $ut_1$ , $ut_2$ .....	k 45 00
4552. <b>Universal Magnetic Interrupter</b> , with two supports and ten diapasons, carrying riders, so that the experimenter can produce any desired number of interruptions per second, from 30 to 256.....	k 220 00

## SECTION II.—THE SIREN.

4560. <b>Siren</b> of Cagniard de Latour, with register.....	27 00
4561. <b>Toothed Wheel</b> of Savart, large model, with bar for the low pitch, and register.....	175 00
4562. <b>Toothed Wheel</b> of Savart, small but very satisfactory and portable model, without bar or register.....	50 00
4563. <b>Gyroscope</b> , with toothed wheel, answering the purpose of the wheel of Savart, very perfectly .....	6 00

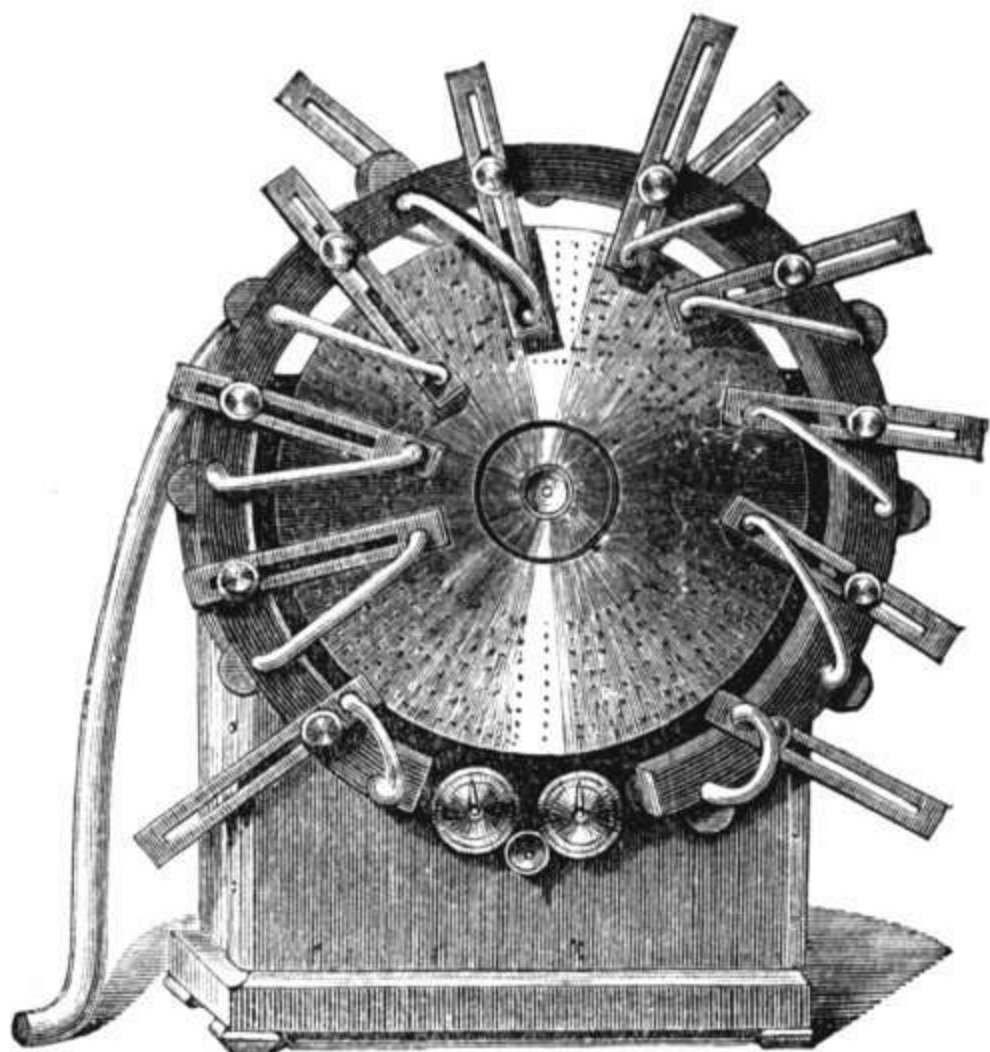

4564.

- |   | PRICE     |
|---|-----------|
| 4564. <b>Grand Siren of Seebeck.</b> A strong system of clock-work, serves to keep in motion a copper disc, pierced with holes at regular intervals. A common air-chamber communicates with a series of tubes which can be accurately adjusted in front of the revolving disc, at any required position. A register gives the velocity of rotation. Of the nine discs furnished with the instrument, four are intended to show the results obtained when the <i>isochronism</i> of the impulses is imperfect from any cause; the fifth shows that impulses coming from different points can unite to form one sound; the sixth serves for experiments on interference; the seventh has eight series of holes, giving the gamut; the eighth has eight series of holes for the harmonics; the ninth illustrates the phenomena of beats. . . . . | k\$224 00 |
| 4565. Seebeck's Siren, with feebler clock work, without register, with seven discs of card-board. . . . .   | k 67 00   |
| 4566. <b>Oppelt's Siren.</b> Disc of card-board, 19 inches in diameter, pierced with several series of holes, and adapted for use with any rotator. . . . .   | k 9 00    |
| 4567. <b>Oppelt's Siren.</b> Same as No. 4566, but made of zinc instead of card-board. . . . .  | k 13 50   |
| 4568. <b>Helmholtz's Double Siren.</b> For description see Tyndall's Lectures on Sound. . . . .   | k100 00   |

## SECTION III.—OF PITCH, INTENSITY AND TIMBRE.

- |  |         |
|--|---------|
| 4570. <b>Four Diapasons,</b> forming perfect chord, $ut_3, mi_3, sol_3, ut_4$ , mounted upon resonant cases. . . . .                         | 32 00   |
| 4572. <b>Diapason <math>ut_3</math>,</b> giving 256 complete vibrations per second, mounted upon its resonant case. . . . .                  | 8 50    |
| 4573. <b>Grand Diapason <math>ut_2</math>,</b> 128 vibrations, mounted upon its resonant case..  | 20 00   |
| 4574. <b>Official Diapason, <math>la_1</math>,</b> giving 435 complete vibrations, mounted upon its resonant case. . . . .                   | 8 50    |
| 4575. <b>Thirteen Diapasons,</b> with box, giving the tempered gamut from $ut_3$ to $ut_1$ , based upon the $la_3$ , 435 vibrations. . . . . | k 25 00 |

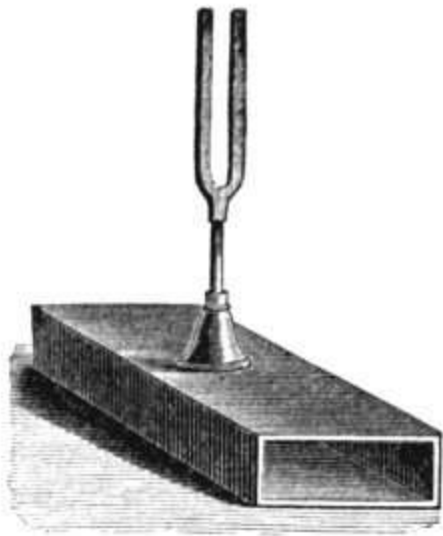

4572 and 4573.

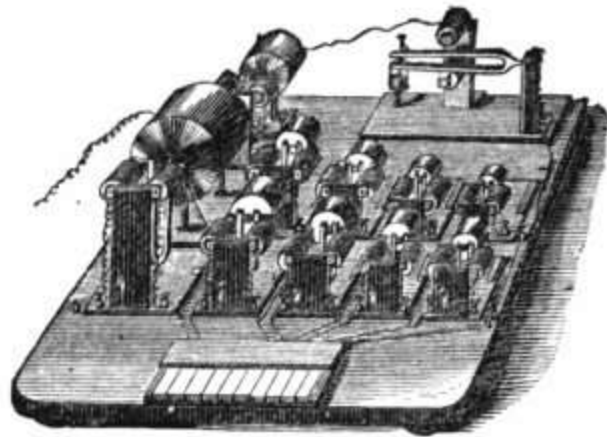

4581.

	PRICE
4577. Series of ten cylinders of Steel to determine the limit of acute sounds .....	\$20 00
4578. Helmholtz's Resonators. Series of ten .....	30 00
4579. Helmholtz's Resonators. Series of nineteen.....	50 00
4580. Helmholtz's Resonators. Series of fourteen adjustable from sol <sub>1</sub> to ut <sub>6</sub> .....	k 78 00
4581. Helmholtz's Apparatus for the artificial composition of the different "timbres" or "clang tints," consisting of ten diapasons fastened between the poles of ten electro-magnets, traversed by an intermittent current. These intermittences are produced by a diapason interrupter of 128 vibrations per second.....	k 186 00
4582. Helmholtz's Apparatus. Same as No. 4581, but with the addition of ten diapasons giving the harmonics.....	k 224 00

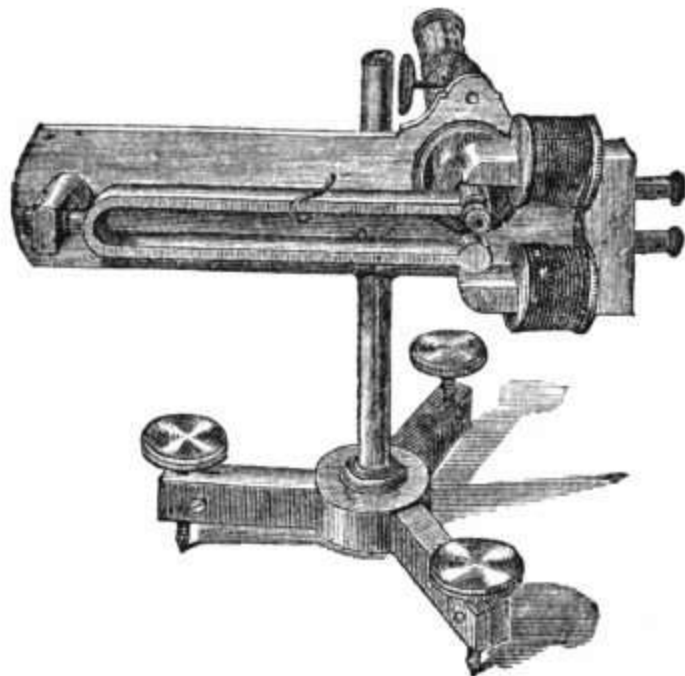

4584.

4583. Optical Comparer of M. Lissajous, without electro-magnet.....	k 18 00
4584. Optical Comparer of M. Lissajous, with electro-magnet.....	k 36 00
4585. Five Diapasons, with resonators in unison with the air-chambers of the mouth in the utterance of the vowels a, e, i, o, u.....	k 25 00

## SECTION IV.—OF THE PROPAGATION, REFLEXION AND REFRACTION OF SOUND.

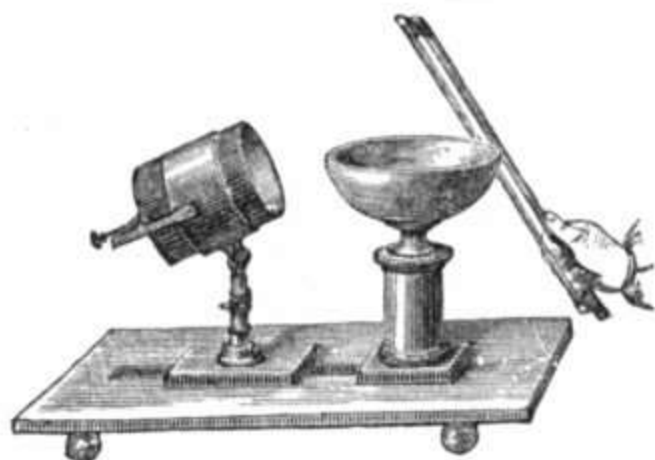

4599.

	PRICE
4595. Bell, suspended from a brass frame by silk cords, to show the enfeeblement of sound in a vacuum.....	\$2 50
4596. Bell, with clock-work, suspended by silk cords, from a brass frame, which is in turn supported on a piece of India rubber.....	12 00
4597. Chladni's Apparatus, to cause an organ tube to sound in different gases.....	16 50
4598. Ten Bars, each one metre in length, of different kinds of wood.....	12 50
4599. Savart's Bell and Resonator, mounted upon a solid support, and with resonator, adjustable in all directions, upon a polished mahogany table.....	20 00
4600. Resonant Jars, for diapasons No. 4570. Series of four for chord. . . .	8 00
4601. Resonant Jars, for diapasons. Series of eight for octave.....	16 00
4602. Seebeck's Ear.....	12 50
4603. Pair of Parabolic Reflectors, thirteen inches in diameter, on adjusting stands.....	35 00
4604. Pair of Parabolic Reflectors, twenty inches in diameter, on adjusting stands.....	60 00
4605. Lens of India Rubber, eighteen inches in diameter, consisting of a brass ring with two sheets of thin rubber fastened upon it and securely covered. A stop-cock communicating to the space between the two rubber sheets allows the entrance of any gas desired, and the closing of the stop prevents the exit. On neat mahogany stand.	15 00
4606. Lens of India Rubber, similar to No. 4605, without the stop-cock, or brass ring, and only twelve inches in diameter.....	4 00
4607. Two Diapasons $ut_1$ , mounted upon their resonant cases, and adjusted to give four beats per second.....	17 00

## SECTION V.—OF VIBRATIONS.

## 1. VIBRATIONS OF AIR.

4620. Large Bellows, with regulator.....	120 00
4621. Bellows, smaller than No. 4620, with regulator.....	80 00
4622. Bellows, same as No. 4621, but without regulator.....	50 00
4623. Manometer, to measure the pressure of the air.....	5 00
4624. Organ Tube, plain, for simple illustration.....	2 50
4625. Open Organ Tube, with one side of glass, with a membrane and cord which can be lowered into the tube, and which will sound in any position in the tube, except at the node.....	4 50
4626. Long Open Tube, one of whose faces is very thin, so that by strewing this face with sand the position of the nodes in the vibrating column of air can be distinctly seen.....	3 50
4627. Open Tube, for manometric flames.....	12 00
4628. Closed Tube, for manometric flames.....	12 00

	PRICE
4629. Organ Tube, with a key at the node, permitting the tube to be closed at this point. . . . .	\$3 00
4630. Organ Tube, with stop-cock at the middle of the vibrating column..	3 00
4631. Organ Tube, with a slide, having holes of various sizes which open at the middle of the vibrating column . . . . .	4 00
4632. Three Equal Tubes, with lumière of different sizes. . . . .	5 50
4633. Tube, which can be closed at the end by a sliding plate, pierced with four holes, which serve successively for mouth-piece. . . . .	4 00
4634. Cubical Tube, arranged as No. 4633. . . . .	4 00
4637. Three similar tubes, in wood of different thickness. . . . .	5 00
4638. Two similar tubes, the interior of one of them lined with cloth. . . . .	4 50
4639. Three similar tubes, one of brass, one of wood, and one of card-board.	6 00
4640. Five tubes of the same size and different lengths, giving the notes ut, ré, mi, fa, sol; and four tubes of the same length and different sizes, giving the notes ré, mi, fa, sol. . . . .	25 00
4641. Cubical Glass Tube, with three pistons, by means of which one can diminish the mass of air contained, alternately, according to the three dimensions, to show the comparative influence of the different dimensions upon the sound. . . . .	15 00
4642. Four Rectangular Tubes (one a cube), giving the same note. . . . .	11 00
4643. Two Closed Cubical Tubes. . . . .	9 00
4645. Two Long Tubes of Glass, one open, the other closed, to give the succession of harmonics. . . . .	5 00
4646. A Long Open Tube, giving a succession of notes corresponding to the numbers 1, 2, 3, 4, which can be opened at the middle of each vibration, and closed at each node by a piston. . . . .	7 00
4647. A Long Tube, closed at one end, same style as No. 4646, with six stop-cocks, and one piston, giving notes corresponding to the numbers 1, 3, 5, 7. . . . .	7 00
4648. A Long Tube, closed at both ends, with movable mouth-piece, which gives, if the mouth-piece remains in the middle, notes as 1, 3, 5, 7, but if moved, the notes 1, 2, 3, 4. . . . .	20 00
4649. Circular Tube. Giving notes 1, 3, 5, 7, which carries a key at the spot where the node always forms. . . . .	10 00
4650. Flute. Composed of a mouth-piece, of two open tubes, each the length of a wave, and one tube the length of half a wave. . . . .	4 50
4651. Water Flute. Composed of two tubes of glass, of different diameters, worked by two flowing columns of water. On neat stand. . .	20 00
4652. Four Tubes. Containing the same mass of air, with mouth-pieces of the same size, one a tetrahedron, one a cube, one a cylinder, and one a sphere. . . . .	14 00
4653. Three Tubes. Of the same length, and containing the same volume of air. One is prismatic and the two others conical. One of the latter tapers just as much toward the mouth-piece as the other does from it. . . . .	8 00
4654. Five Tubes. Of the same length, but bent in different ways. . . . .	14 00
4655. Eight Open Tubes. Giving the gamut from ut <sub>1</sub> to ut <sub>8</sub> . . . . .	13 00
4656. Eight Closed Tubes. Giving the same notes as No. 4655. . . . .	13 00
4657. Four Open Tubes. Giving the perfect chord. . . . .	7 00
4658. Four Closed Tubes, giving the perfect chord. . . . .	7 00

## 2. VIBRATIONS OF MEMBRANES.

4665. Circular Membrane of Rubber, which can be stretched at will. . . . .	3 50
4666. Circular Membrane of Paper. About twelve inches in diameter. . .	2 00
4667. Square Membrane of Paper. Twelve inches on a side. . . . .	2 00
4668. Triangular Membrane of Paper. Twelve inches on a side. . . . .	2 00

## 3. VIBRATION OF CORDS.

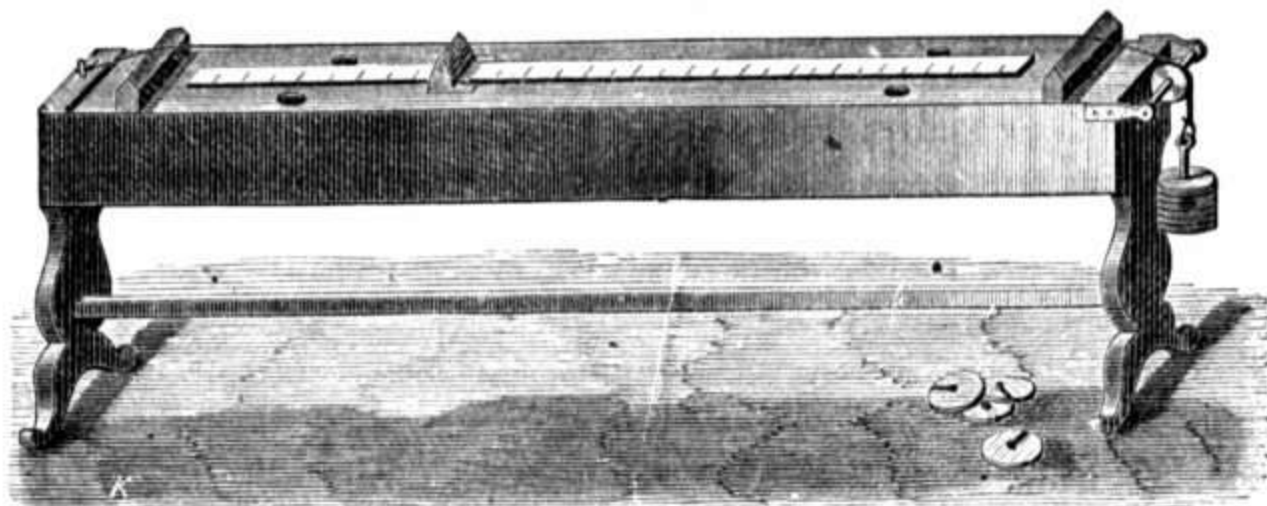

4676.

	PRICE
4675. Sonometer, plain form, sounding-board, bridges, key and cord.....	\$10 00
4676. Sonometer, of mahogany, with sounding-board of spruce, one metre in length between the bridges, two cords and weights, scale to millimetres, and movable bridges for the octave, thirds, &c.....	25 00
4677. Differential Sonometer, with assortment of weights. This instrument is one metre in length between the bridges. Carries three scales, the first the chromatic tempered gamut; the second, the true chromatic gamut and the harmonics; the third is a metre divided to millimetres throughout its length.....	45 00
4678. Apparatus for studying the longitudinal vibrations of cords, one metre in length.....	k 37 50
4679. Two Sonometer Cords of Brass, whose diameters are as 1 to 2.....	50
4680. Two Cords of the same diameter, one of iron the other of platinum..	3 50
4681. Grand Sonometer of M. Berbereau, having eight cords for experiments upon the gamut, &c., &c.....	k 70 00

## 4. VIBRATIONS OF RODS AND BARS.

4690. Four Bars of Steel, of which two are of the same length, same thickness, and different width; a third same length as first and double the thickness; and a fourth of the same thickness as the first but its length is to that of the others as 1: $\sqrt{2}$ .....	7 50
4691. Four Bars of Brass, similar to No. 4690.....	3 25
4692. Four Bars of Wood, do. do. ....	2 00
4693. Six Bars of same size, five of wood of different kind and density, and one of brass.....	4 00
4694. Two Flat Springs of Brass, one a metre in length, the other a half metre, to show the law of the harmonics in transverse vibrations..	4 00
4695. Four Springs of Brass, of the same length, one straight and the others successively more and more curved, to illustrate the nodes in the diapason.....	5 00
4696. Four Springs of Steel, two cylinders of one metre in length and of different diameters, a bar of the same length, and a cylinder half the length.....	11 00
4697. Four Springs, as in No. 4696, but of wood.....	3 00
4698. A Rod and a Tube of Brass, of same diameter, and one metre in length.....	10 00
4699. A Rod of Brass, supported horizontally in a frame, with one end just touching an ivory ball suspended from a frame. As soon as the bar is put into vibration the ball is repelled.....	12 00
4700. Apparatus, to show the nodes on a body vibrating longitudinally, consists of a hair with small rings on it, stretched between two keys on a strong frame.....	2 50

ACOUSTICS.

49

PRICE

4701. **The Claque Bois.** A musical instrument founded upon the transverse vibration of bars. . . . . \$5 00
4702. **Marloye's Harp.** A musical instrument, founded on the longitudinal vibrations of rods, consisting of twenty rods of wood, fastened in a strong support. The white rods give the diatonic gamut, the red rods the half tones; the sound is produced by playing upon the rods with rosined fingers. . . . . 23 00

5. VIBRATION OF PLATES.

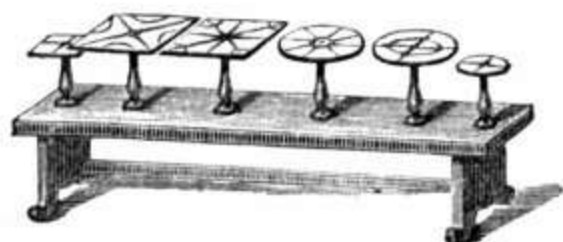

4710.

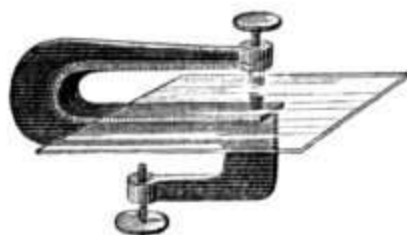

4719.



4721.

4710. **Bench, with Screw Supports for Six Plates of Brass,** three round and three square. Two plates of each shape are of the same size, but one double the thickness of the other. Each pair is accompanied by a third plate of the same thickness as the first but of half the diameter. . . . . 25 00
4711. **Smaller Bench, with three plates only, either round or square.** . . . . 12 50
4712. **Circular plate of brass, 12 inches in diameter.** . . . . 4 50
4713. **Square plate of brass, 12 inches on the side.** . . . . 4 50
4714. **Triangular plate of brass, 12 inches on a side** . . . . 4 50
4715. **Hexagonal plate of brass, 12 inches across.** . . . . 4 50
4716. **Series of four plates of plate-glass, finely finished, nine inches on a side, or in diameter, including the circle, square, triangle, and hexagon.** . . . . 8 00
4717. **Series of four plates of plate-glass, finely finished, five inches on a side, or in diameter, including the circle, square, triangle, and hexagon. For use in projection.** . . . . 5 00
4718. **Universal support for plates, composed of four screw-clamps.** . . . . 18 00
4719. **Simple support for plates, to be clamped to a table** . . . . 5 00
4720. **Simple support for plates, to be held in the hand.** . . . . 5 00
4721. **Simple support for plates held at the centre.** . . . . 4 00
4722. **Support for plates when used for projection, having, besides the main clamp, another to fasten at the node.** . . . . 12 00
4723. **Glass Bell, mounted upon a base. A frame carries four balls, which touch the edge of the bell. When the bell is set into vibration by the bow the balls are repelled if they are not in the nodes.** . . . . 8 50

SECTION VI.—ON THE COMMUNICATION OF VIBRATIONS THROUGH THE AIR, OR OTHERWISE.

4730. **Two Diapasons  $ut_3$  in unison, and mounted upon their resonant cases.** . . . . 17 00
4731. **Two plates of brass of the same form, size, and thickness, one of which is mounted upon a base and the other with a handle. On setting the latter in vibration and holding it above the former, having strewn black sand over each, the vibration will be transmitted to the lower one, and the sand on both the plates will assume the same figures.** . . . . 9 00

	PRICE
4732. <b>Tube of Brass.</b> Twenty-four inches long, with a plate of brass ten inches in diameter attached to one end. A hoop, with either of the discs Nos. 4665 or 4666, is placed upon the floor or table, and the experiment No. 4731 is performed by rubbing the tube with a rosined rag. ....	\$6 00
4733. <b>Tube of Glass.</b> For singing flame, mounted on a base. ....	4 00
4734. <b>Tube of Glass.</b> For sensitive flame, mounted on a base. ....	4 00
4735. <b>Set of four Glass Tubes.</b> For sensitive flames, mounted on a neat base, with hose for each tube. ....	10 00
4736. <b>Tube of Brass.</b> For singing or sensitive flame, with support for glass tube on the same stand. ....	6 50
4737. <b>Neatly Japanned Tin Tube.</b> One metre in length. ....	3 00
4738. <b>Neatly Japanned Tin Tube.</b> Two metres in length. ....	6 00
4742. <b>Apparatus for the transmission of vibrations through liquids.</b> ....	5 50
4743. <b>Free Reed.</b> Carried upon a glass wind-chest, surmounted by a tube in unison with the reed, and which can be lengthened to triple its length. ....	k 5 75
4744. <b>Free Reed.</b> Mounted upon a glass wind-chest, with two harmonic cornets of different form to show their influence upon the timbre. .	k 5 50
4745. <b>Beating Reed.</b> Mounted as No. 4744, and carrying the same cornets. .	k 5 75
4750. <b>Two square plates of Brass.</b> Fastened together by one corner. One larger than the other. ....	4 50
4751. <b>Two round plates of Brass</b> of different sizes. Joined by their circumference. ....	4 50
4752. <b>Two square plates.</b> Of same size, joined by the corner. ....	4 50
4753. <b>Two round plates.</b> Same size, joined by the circumference. ....	4 50

SECTION VII.—ON THE PHENOMENA RESULTING FROM THE CO-EXISTENCE OF TWO OR MORE SOUNDS IN THE AIR.

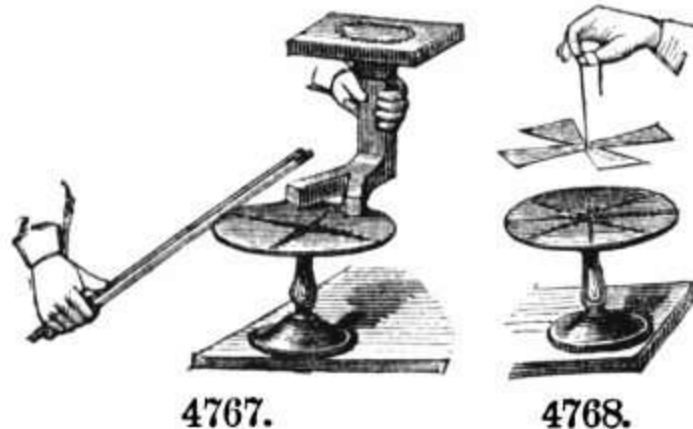

4765. <b>Two Diapasons</b> $ut_2$ in unison. Each mounted upon a support, between the poles of an electro-magnet, with a diapason interrupter $ut_2$ . ....	k 72 50
4766. The two Diapasons of No. 4765, without the interrupter. ....	k 60 00
4767. <b>Interference Tube.</b> Tube with two arms, surmounted by a disc of thin paper. When held over the opposite sections of a vibrating plate, the vibrations of the two arms of the tube act in unison; when held over contiguous sections the one neutralizes the other. ....	k 8 00
4768. <b>Interference Apparatus</b> of M. Lissajous. A circular plate of brass on stand, and three discs of zinc, cut to correspond with the successive divisions of the plate in vibration. ....	k 22 50
4769. <b>The three Discs of Zinc</b> of No 4768, without the plate and stand. ....	k 14 00



PRICE

4770. **Five open Organ Tubes.** Two giving  $ut_2$ , and the others  $mi_2$ ,  $sol_2$ , and  $ut_3$ . All so adjusted that they can be made to vary half a tone.  $\frac{1}{2}$  \$19 00
4771. Two Organ Tubes. Giving  $ut_2$ , and adjustable as in No. 4770. . . . . k 9 00
4772. Two open Tubes. Giving the fourth. For the resultant sounds. . . . k 2 50
4773. **Helmholtz's Double Siren** . . . . . k 100 00

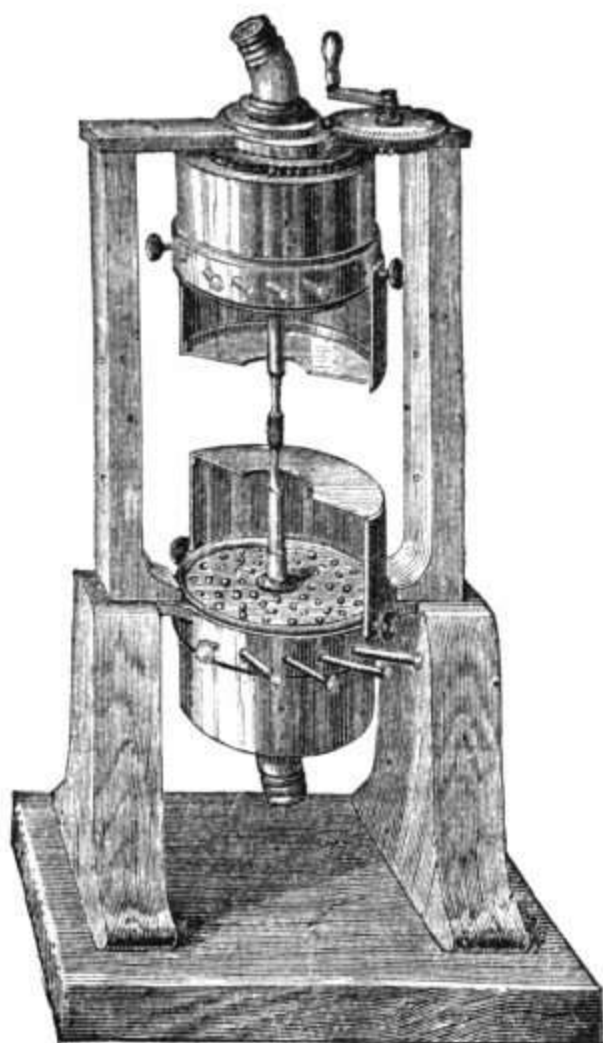

4773.

SECTION VIII.—METHODS OF OBSERVING SONOROUS VIBRATIONS WITHOUT THE USE OF THE EAR. COMPRISING THE GRAPHIC METHOD; THE OPTICAL METHOD; THE METHOD OF MANOMETRIC FLAMES; AND THE METHOD WITH THE STROBOSCOPE.

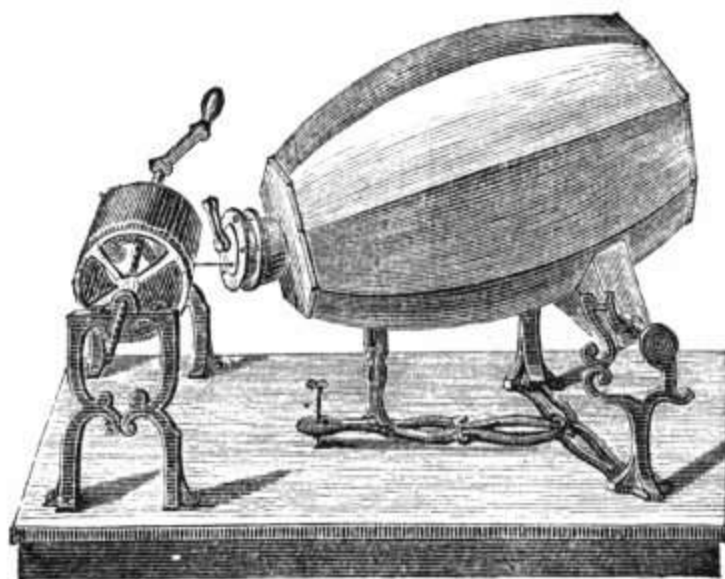

4785.

4785. **The Phonautograph.** With chronometer marker, and diapason chronoscope, complete . . . . . \$ 112 00

4787. **The Cylinder** on its stand, chronometer marker, diapason chronoscope, and stands of No. 4785, without the vibrating membrane and tracer. . . . . k \$62 00
4788. **The Cylinder**, with the screw movement and crank alone, on its stand k 37 50
4789. **Regnault's Chronograph**. Consisting essentially of a Bond's magnetic register, with three pairs of diapasons dividing the space on the cylinder, indicating seconds, into the  $\frac{1}{60}$ ,  $\frac{1}{100}$  or the  $\frac{1}{60}$  part. With apparatus for rolling on and fuming the paper to be used. . . k 222 00
4790. **Regnault's Chronograph** similar to No. 4789, but with only one pair of diapasons. . . . . k 178 00
4791. **Regnault's Chronograph**, with one pair of diapasons, but without the apparatus for rolling and fuming the paper. . . . . k 133 00
4792. **Interrupter**, with four diapason interrupters of 30, 60, 120, and 180 per second; and a support, fitted with electro-magnet suited to receive four writing diapasons in unison with the above. . . . . k 90 00
4793. **Interrupter**. Similar to No. 4792, but with three pairs of diapasons. 50, 100 and 200 to the second. . . . . k 73 00
4794. **Interrupter**. As No. 4792, but with three pairs of diapasons, 32, 64 and 128 per second. . . . . k 73 00
4795. **Interrupter and Marker**. Of  $\frac{1}{100}$  of a second. . . . . k 47 00
4796. **Interrupter and Marker**. Of  $\frac{1}{30}$  of a second. . . . . k 49 00
4801. **Large Lissajous Apparatus**. Or apparatus for the optical method alone. Microscope for comparing ten large diapasons, with polished steel mirrors and riders with adjustments from  $ut_1$  to  $ut_3$ . With stand and lamp. . . . . k 267 00
4802. **Lissajous Apparatus**. For the composition of *two movements* by the optical method. Six diapasons with steel mirrors, and stand and a lamp. . . . . k 78 00
4803. The same as No. 4802, but with feebler diapasons and glass mirrors. k 45 00
4804. **Lissajous Apparatus**. With *four* diapasons. . . . . k 37 50
4805. **Open Organ Tube**. With capsules and gas jets to show the position of the nodes by the method of *manometric flames*. . . . . 12 00
4806. **Closed Organ Tube**. As No. 4805. . . . . 12 00

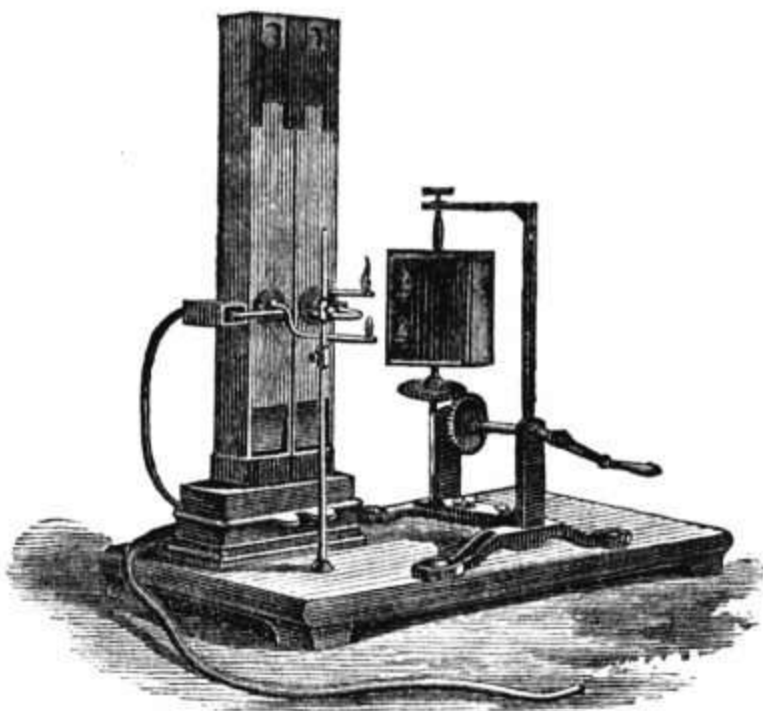

4807.

4807. **Apparatus for the comparison and composition of the vibrations of two columns of air by the method of manometric flames**, with five tubes, two  $ut_2$ , and the three others  $mi_2$ ,  $sol_2$ , and  $ut_3$ . So arranged that each can be varied half a tone. . . . . 60 00

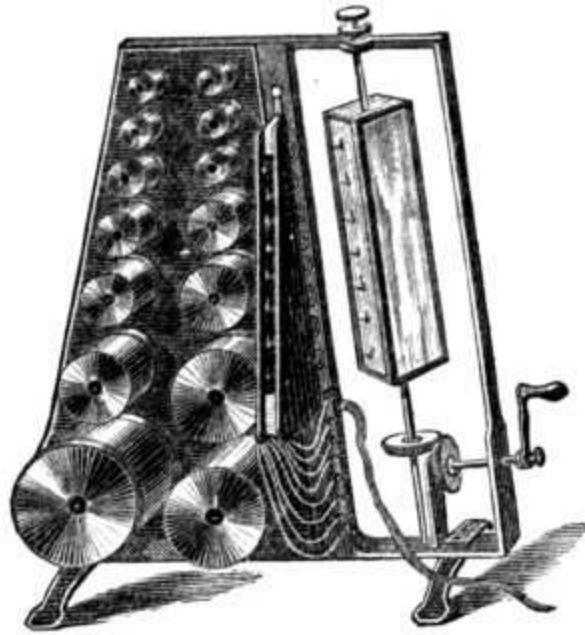

4809.

PRICE

4808. **Apparatus.** To resolve, in a manner to be seen by the eye, the "timbre" of a sound into its elementary notes by means of manometric flames. The ten Helmholtz Resonators No. 5578 are fixed upon a support one above the other. Each communicates by a small rubber tube with a little cavity which forms the manometric capsule. The gas jets of these capsules are placed one above the other, upon an inclined line, and a revolving mirror whose axis is parallel to this line, decomposes those of the flames which are put into vibration by the resonant globes, while those flames not put into vibration appear simply as a line of light. . . . . k \$67 00
4809. **Apparatus.** Same as No. 4808, but with fourteen adjustable resonators, suited to the analysis of the *timbre* of any sound whatever. . . . . k 133 00
4810. **Small Revolving Mirror.** With a manometric capsule on stand, with rubber tube to attach the resonator. . . . . 12 00
4811. **Manometric Capsule** alone, with rubber tube. . . . . 5 00
4813. **Kundt's Vibroscope.** For polarization. . . . . k 45 00
4814. **Strong Vise and long bar of glass** to show same as No. 4813. . . . . 15 00
4815. **Apparatus to Examine the Vibrations of Bodies by the Stroboscopic Method.** Composed of a universal electric interrupter, with two supports and ten graded diapasons, with riders. The diapasons range from  $ut_1$  to  $ut_3$ , and the positions of the riders for intermediate vibrations are marked upon the branches. An arrangement for opening and closing a narrow slit, by means of an electro-magnet, so that a light, intermittent in its nature, may fall upon the body whose movements are to be studied, completes the whole. . . . . k 245 00
4816. **Wheatstone's Kaleidophone.** Consisting of twelve bars whose vibrations produce the figures of the rectangular combination of two vibrations for different intervals. . . . . 30 00
4817. **Wheatstone's Kaleidophone for projection.** Similar to No. 4816, but with steel mirrors and a base of lead to be held in a vise. . . . . 42 00
4818. **Wheatstone's Kaleidophone.** With only six bars. . . . . 18 00
4819. **Wheatstone's Kaleidophone for projection,** with only six bars. . . . . 20 00
4820. **A Series of Reed Pipes** giving the gamut,  $ut_3$  to  $ut_4$ , carrying mirrors by which the vibrations of the reed can be thrown upon a screen, and the relation between the different notes made apparent to the eye. . . . .
4821. **Lissajous Apparatus.** Consisting of a pair of steel forks, about 15 inches long, with mirrors mounted so as to greatly amplify the motion. The forks are mounted on bases, so as to allow all necessary movements. With this apparatus the figures may be made several feet in diameter on the screen. . . . . 20 00

## CHAPTER VI.

## HEAT.

## SECTION I.—ARTIFICIAL SOURCES OF HEAT.

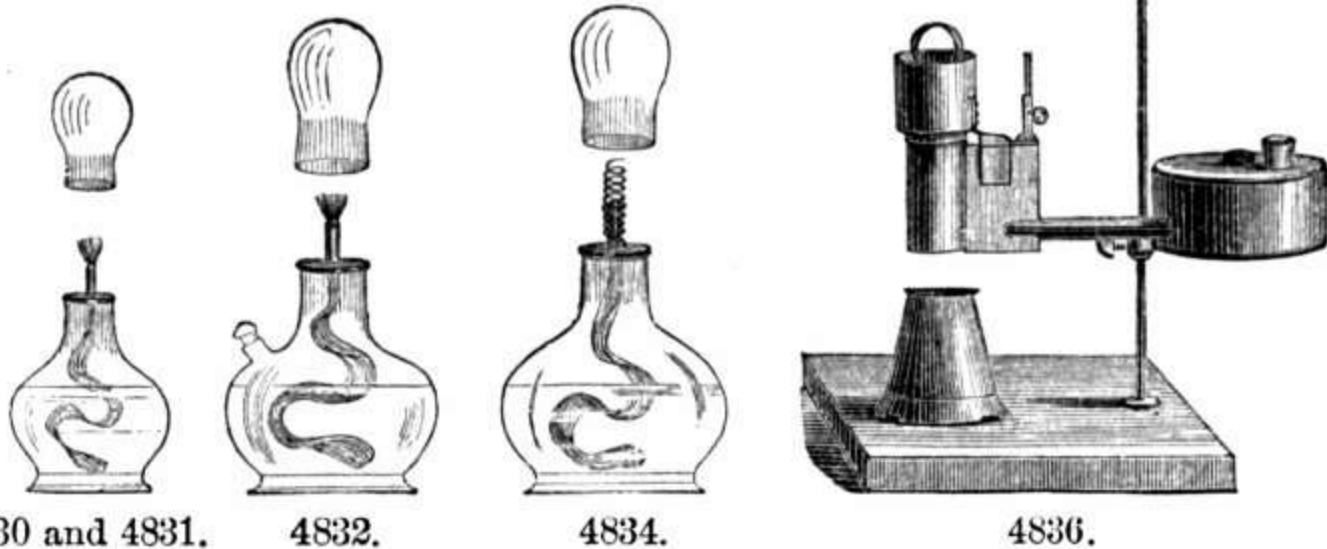

	PRICE
4830. <b>Spirit Lamp</b> , plain, of glass, with ground cap. Capacity two ounces..	\$0 50
4831. Spirit Lamp, same as No. 4830, but holding four ounces.....	75
4832. Spirit Lamp of glass, with ground cap, and aperture for filling without removing the wick. Capacity two ounces.....	50
4834. <b>Aphlogistic Lamp</b> , similar to No. 4831, but with coil of platinum wire	1 50
4835. <b>Berzelius Lamp</b> , of strong tin, neatly japanned.....	1 00
4836. Berzelius Lamp, of brass, with rack movement for the wick, and metal chimney, on stand.....	6 00
4842. <b>Bunsen's Gas Burner</b> , single tube without regulator.....	75
4843. Bunsen's Gas Burner, same as No. 4842, but with regulator for supply of air.....	1 00
4844. Bunsen's Gas Burner, with air regulator, as No. 4843, and stop-cock for regulating the flow of gas.....	2 00
4845. Bunsen's Gas Burner, with key for adjusting the flow both of the air and the gas. Improved form.....	2 00
4846. Bunsen's Gas Burner, with three tubes and regulator for supply of air.	3 00
4847. <b>Bunsen's Blast Lamp</b> , for gas, with one pair of tubes for glass-blowing, melting metals, and any other intense heating, with stop-cock on each tube.....	7 00
4848. Bunsen's Blast Lamp, with 6 pairs of tubes, without stop-cocks.....	10 00
4849. Bunsen's Blast Lamp, same as No. 4848, but with 18 pairs of tubes.....	15 00
4850. Bunsen's Blast Lamp, arranged for hydro-oxygen light.....	10 00
4851. <b>Hydro-oxygen Apparatus</b> , complete. See Chapter XI.	



For Electric batteries, lamps, etc., for deflagration, etc., see Chap. VII., section IX.

SECTION II.—INSTRUMENTS WHICH ILLUSTRATE THE CHANGE OF VOLUME CAUSED BY HEAT.



4834.

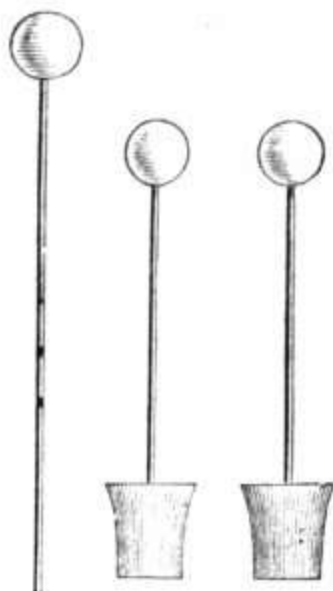

4900.

4901.

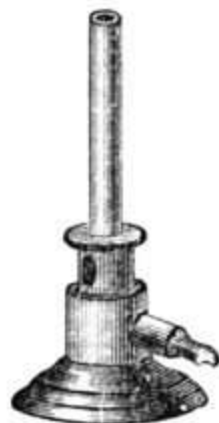

4843.

	PRICE
4900. <b>Air Thermometer.</b> Glass tube fifteen inches long, with bulb two inches in diameter.....	\$0 25
4901. Pair of Air Thermometers similar to No. 4900, with glass beakers...	1 00
4902. <b>Apparatus to show expansion of a liquid.</b> consisting of an air thermometer and glass beaker, with stand and holder.....	2 00
4903. <b>Apparatus to show comparative expansion of two liquids.</b> A pair of air thermometers on neat stands, one to be partly filled with colored water, the other with alcohol. A large glass beaker to be filled with hot water. For projection by lantern.....	4 00
4904. <b>Apparatus to show maximum density of water.</b> An air thermometer on stand, and a copper vessel for the freezing mixture. For projection by lantern.....	5 00
4905. <b>Apparatus for maximum density of water.</b> A glass cylinder twelve inches high, with a thermometer inserted horizontally near the top and another near the bottom. A jacket of copper to contain a freezing mixture surrounds the middle.....	8 00

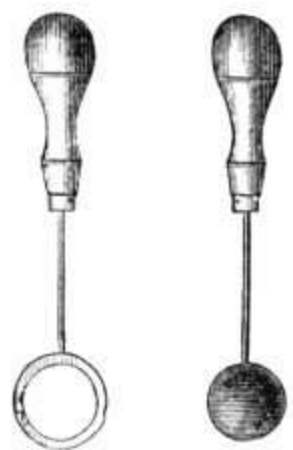

4906.

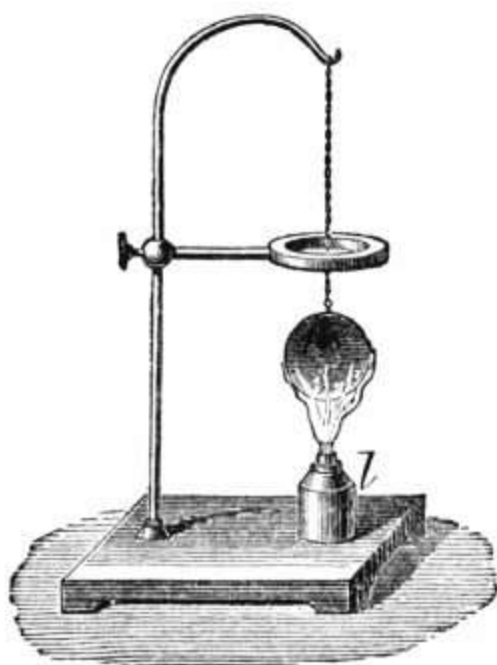

4907.

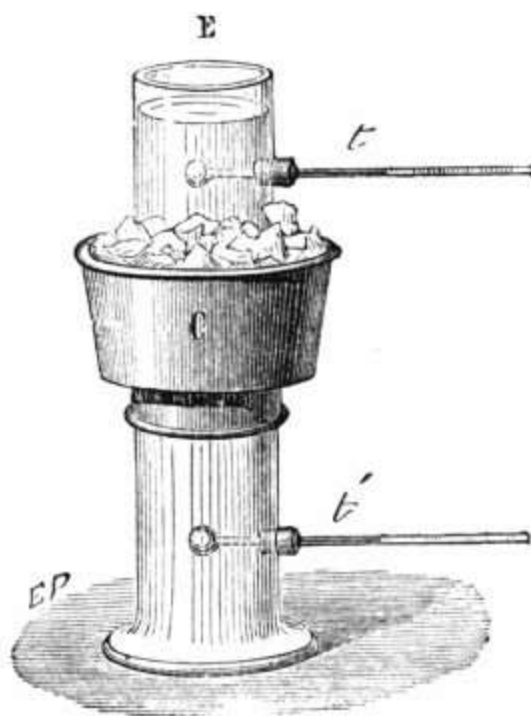

4905

4906. <b>Ball and Ring</b> .....	1 75
4907. <b>Ball and Ring on stand, with alcohol lamp</b> .....	3 00
4908. <b>Pyrometer with two metals, with lamps</b> .....	5 00

	PRICE
4909. <b>Compound Bar.</b> To show the comparative expansion of two metals (brass and iron); twelve inches long, with a wooden handle. . . . .	\$1 00
4910. <b>Compensating Pendulum.</b> Bars of brass and iron; small model. .D. F.	6 25
4911. <b>Compensating Pendulum.</b> Rod of brass with compensator of mercury.	12 50

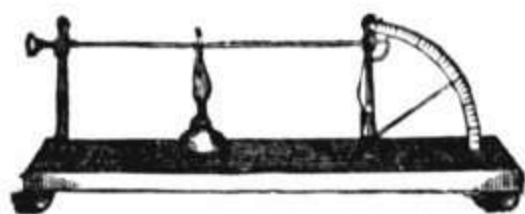

4908.

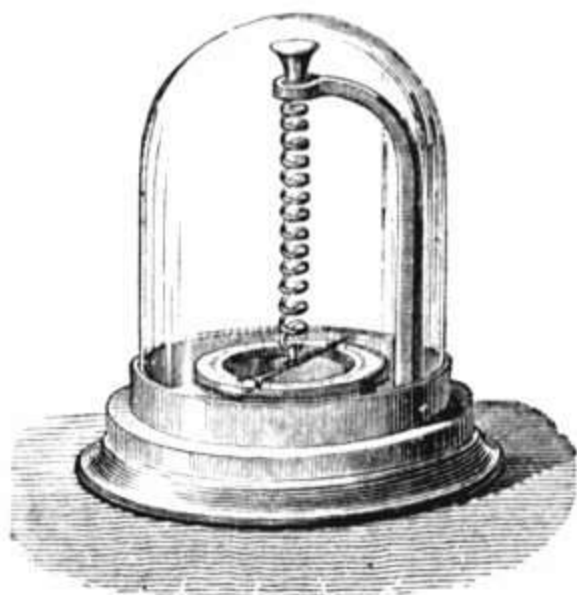

4913.

4912. <b>Wedgewood's Pyrometer</b> . . . . .	15 00
4913. <b>Breguet's Metallic Thermometer</b> . . . . . D. F.	25 00
4914. <b>Apparatus to show the Contraction of India-Rubber by Heat.</b> Consisting of a firm base of mahogany supporting a rod of iron with clamps and arms for attaching the India-Rubber, and surrounding it with a sheet-iron tube; and also a post with a lever of very long light arm suspended upon it as a fulcrum, and held down at one end by a spiral spring. A weight of ten pounds and an alcohol lamp complete the arrangement. See Tyndall's Lectures . . . . .	20 00
4915. <b>Geyser Illustration.</b> Consisting of a galvanized iron tube six feet long, surmounted by a basin of the same material two and a half feet in diameter. The whole instrument is mounted upon a tripod, and heated at the bottom, and two feet above it, by two charcoal furnaces. A series of stops and cocks permits the operator to illustrate various intermittent geyser actions . . . . .	25 00

## SECTION III.—THERMOMETERS.

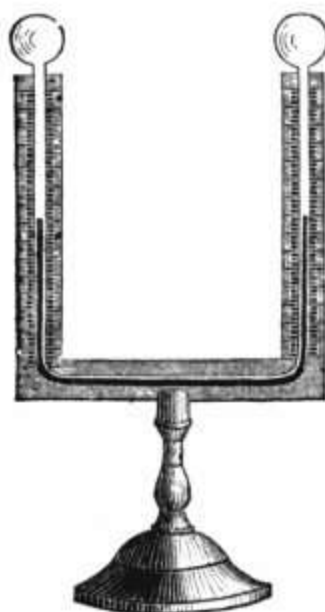

4926.

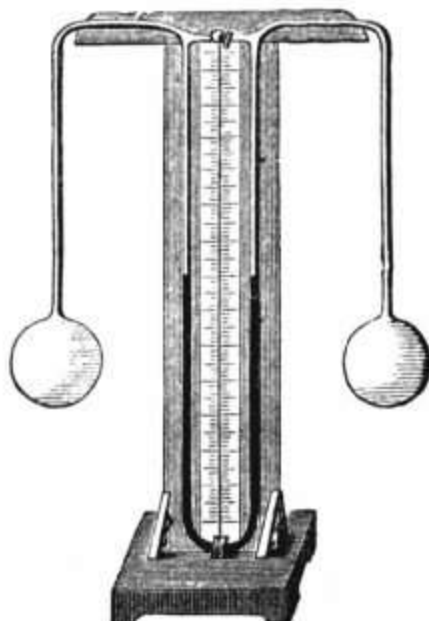

4927.

THERMOMETERS.

57

	PRICE
4925. <b>Leslie's Differential Thermometer on stand</b> .....	\$3 00
4926. <b>Leslie's Differential Thermometer, on mahogany stand, with scale on both arms</b> .....	4 00
4927. <b>Matthiessen's Differential Thermometer.</b> A short tube with clamps connects the upright tubes near the top, and permits the pressure, <i>i e.</i> , the <i>temperature</i> of the two arms to be speedily equalized. All mounted upon a neat mahogany stand with scale.....	10 00
4928. <b>Matthiessen's Differential Thermometer.</b> With <i>glass</i> upright and scale to permit use in the lantern for projection. The position of the bulbs in this form of the differential thermometer gives it a great advantage over the old form, and when used for projection it dispenses in many cases with the more delicate thermo-multiplier No. 4964.....	15 00

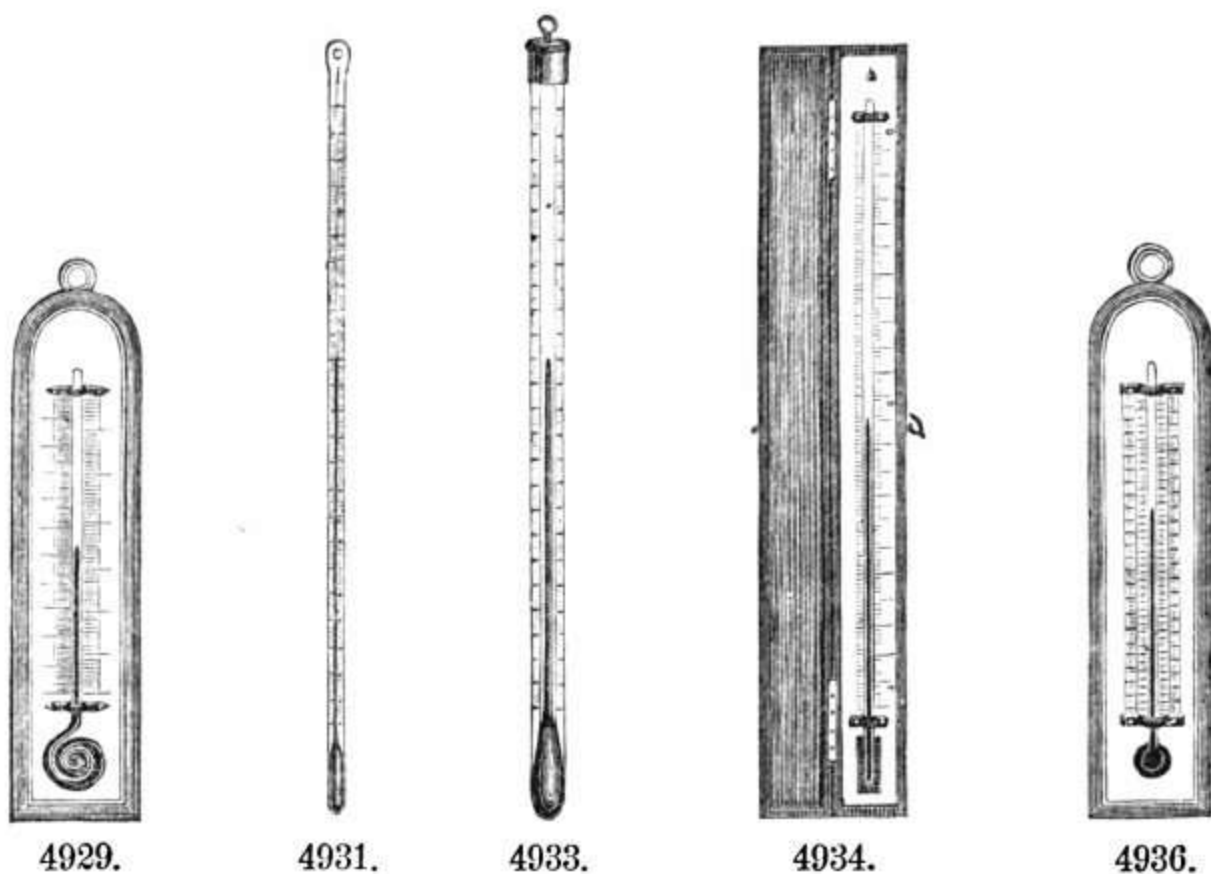

4929. <b>Alcohol Thermometer</b> , ten inches long, with spiral bulb; 40° to + 130°.	2 00
4931. <b>Mercurial Thermometer</b> , graduated on the tube and reading to 400°, in case.....	1 75
4932. <b>Mercurial Thermometer</b> , thirteen inches long, graduated on the tube and reading to 600°; in case.....	2 25
4933. <b>Mercurial Thermometer</b> , reading to fifths of a degree, inclosed in a glass tube with porcelain scale, and furnished with a brass cap and hook for suspension; eighteen inches long.....	11 00
4934. <b>Normal or Standard Thermometer.</b> 24 inches long, divided upon tube to fifths of a degree, from 0° to 110° Centigrade, in a neat morocco case.....	12 50
4935. <b>Normal or Standard Thermometer</b> , engraved upon the tube, from -40° to +220° Fahrenheit; in neat case.....	15 00
4936. <b>Comparative Thermometer</b> , eight inches long, carrying the three scales, Centigrade, Reaumur, and Fahrenheit.....	2 50
4937. <b>Comparative Thermometer</b> , similar to No. 4936, but with the scales engraved upon glass to permit of projection upon a screen by the lantern.....	5 50

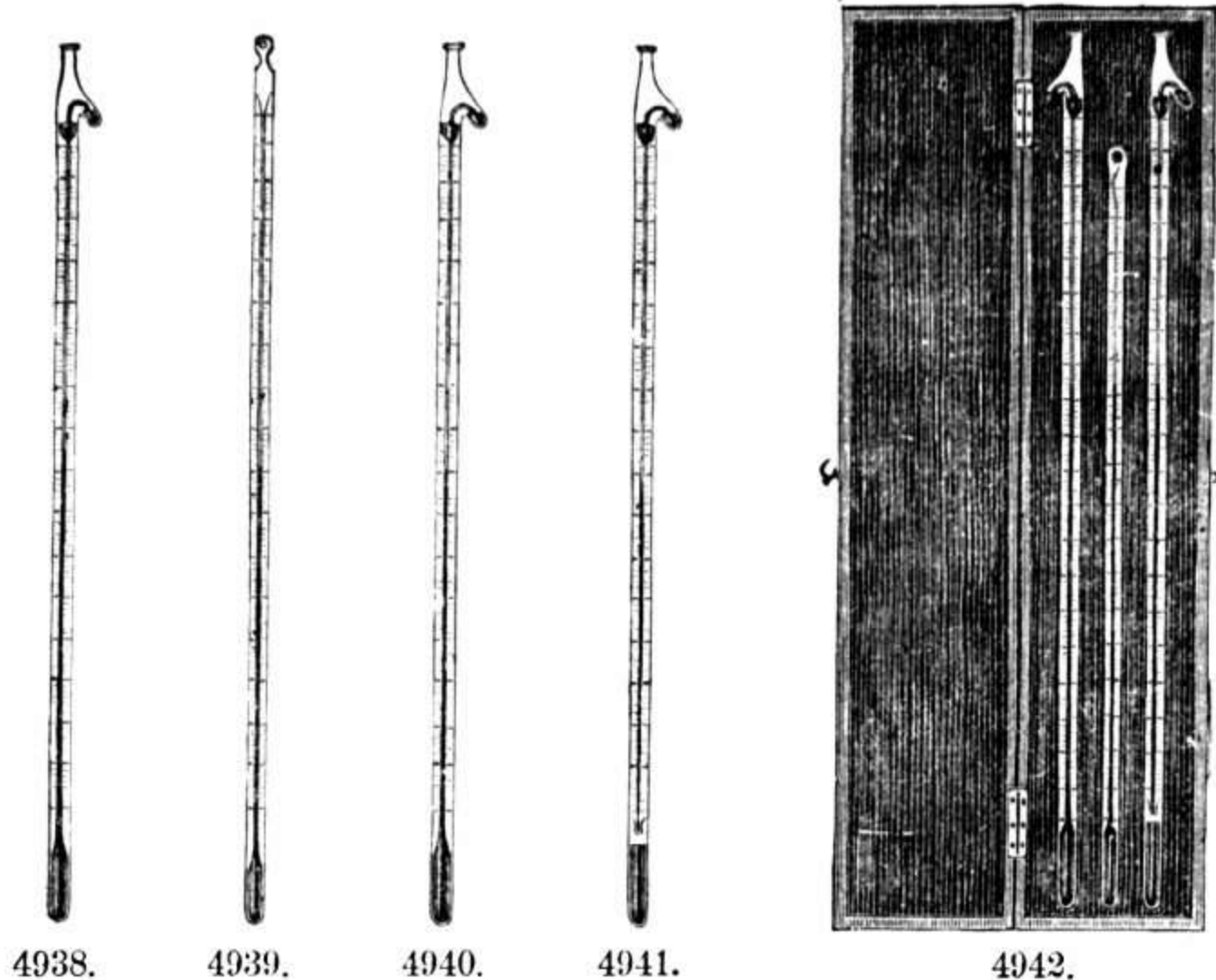

	PRICE
4938. <b>Metastatic Thermometer of Walferdin</b> , 16 inches long, to measure very small differences of temperature anywhere between the freezing-point and the boiling-point of mercury.....	\$12 50
4939. <b>Metastatic Differential Thermometer of Walferdin</b> , 13 inches long, containing alcohol instead of mercury, and of course showing slighter differences of temperature than is possible with mercury..	12 50
4940. <b>Maximum Thermometer of Walferdin</b> , divided upon the tube.....	12 50
4941. <b>Minimum Thermometer of Walferdin</b> , divided upon the tube.....	12 50
4942. <b>Maximum Thermometer and Minimum Thermometer of Walferdin</b> , Nos. 4940 and 4941, with Normal Thermometer No. 4934, inclosed in a neat morocco case.....	35 00
4943. Same as No. 4942, without the Standard Thermometer.....	25 00

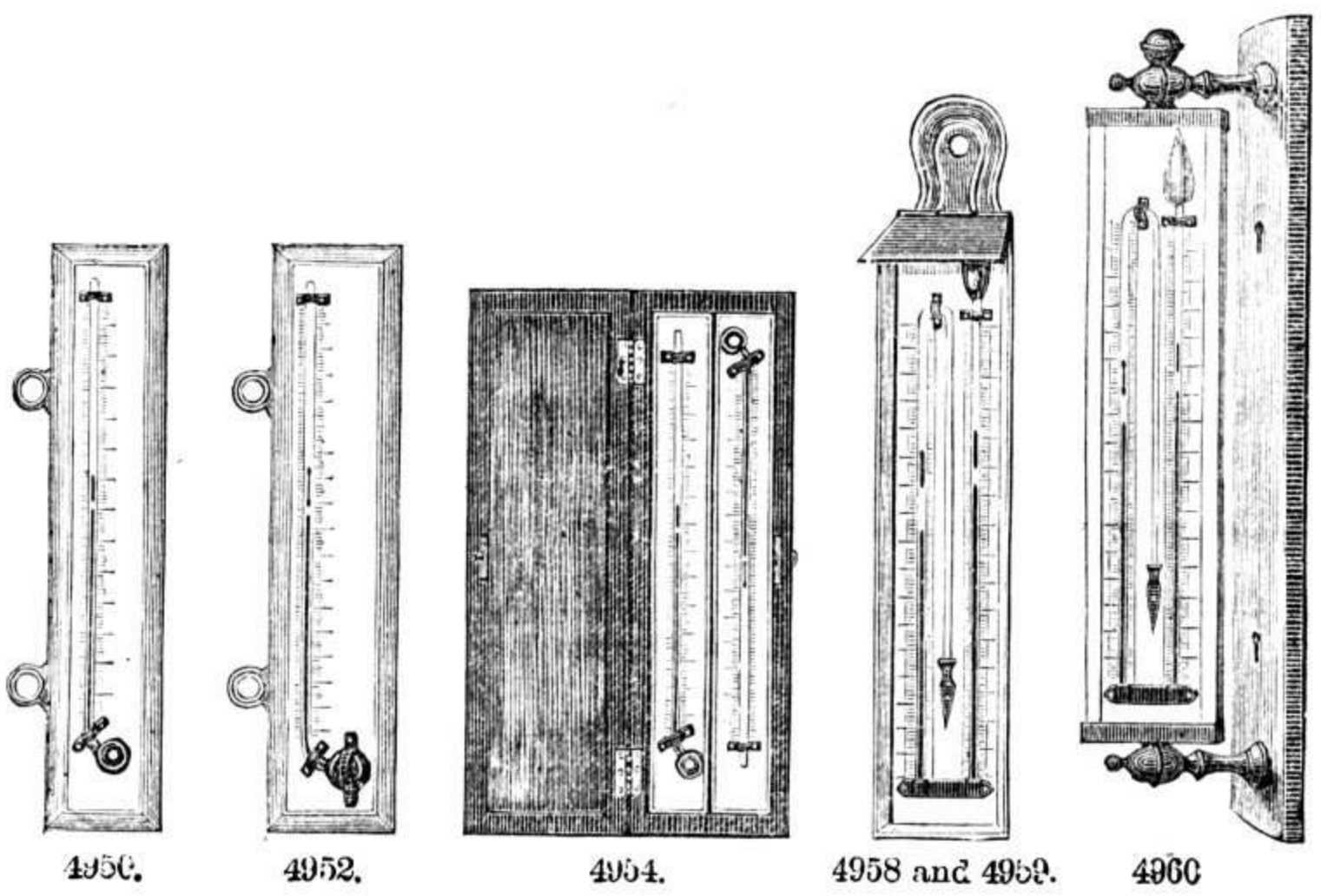

4950.                      4952.                      4954.                      4958 and 4959.                      4960



THERMOMETERS.

59

PRICE

- 4950. **U. S. Signal Service Maximum Thermometer**, twelve-inch solid metal scale, enameled tube..... 5 50
- 4951. **U. S. Signal Service Minimum Thermometer**, solid metal scale, twelve inches long..... 4 00
- 4952. **Standard Maximum Thermometer**, engine divided on stem, with porcelain or opaque glass scale, in oak frame, fourteen inches long..... 8 00
- 4953. **Standard Minimum Thermometer**, divided on stem, with porcelain or opaque glass scale, in oak frame, fourteen inches long..... 8 00
- 4958. **Six's Maximum and Minimum Thermometer**, scale eight inches long, mounted in painted tin case, with roof, for protection from sun and weather..... 7 50
- 4959. **Six's Maximum and Minimum Thermometer**. Similar to No. 4958, but with scale fourteen inches long..... 10 50
- 4960. **Six's Maximum and Minimum Thermometer**. 18 inches long, mounted on a porcelain plate. The plate with the thermometers turns upon pivots in the ends, and is fastened by two arms to a strong oak back, to render it available as a *window* thermometer..... 18 00

For complete list of thermometers, see **Meteorological Catalogue**.

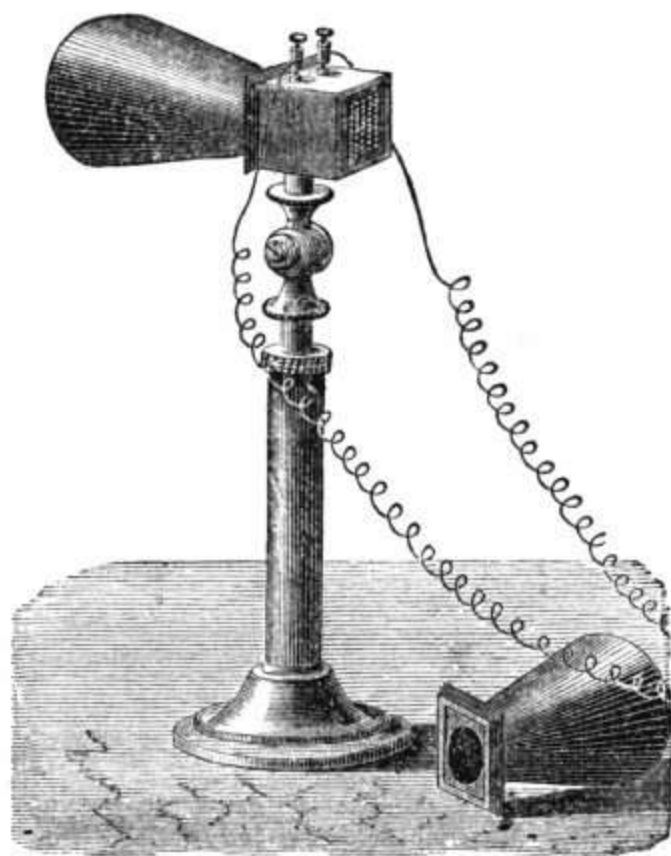

4964 to 4966.

- 4964. **Thermo-Multiplier**. Twenty-five pairs of bismuth and antimony, in brass case, with elevating and adjusting stand, clamp, caps, and cones..... 30 00
- 4965. **Thermo-Multiplier**. Similar to No. 4964, but with thirty-six pairs.... 35 00
- 4966. **Thermo-Multiplier**. Similar to No. 4964, but with forty-nine pairs.. 40 00

For Galvanometer, see **Electricity** ; Chapter VII, Nos. 5540 and 5543.

## SECTION IV.—OF ABSORPTION, RADIATION, REFLECTION, REFRACTION, AND POLARIZATION.

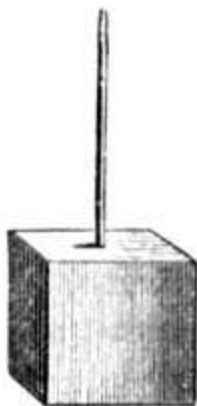

4975.

	PRICE
4975. <b>Leslie's Radiator</b> , 3 inches on a side, of different metals on different sides.....	\$2 00
4980. <b>Apparatus</b> to show that radiant heat varies inversely as the square of the distance. Used with the thermo-multiplier, Nos. 4964, '65 and '66. It consists of a flat tin vessel for water, twenty-four inches square, with one side blackened; mounted upon a stand of cast-iron, and kept at a boiling temperature by a lamp or Bunsen's burner. Without lamp, or Bunsen's burner.....	7 00
4981. <b>Pair of Parabolic Reflectors</b> , thirteen inches in diameter, with elevating stands, ball and phosphorus cup.....	10 00

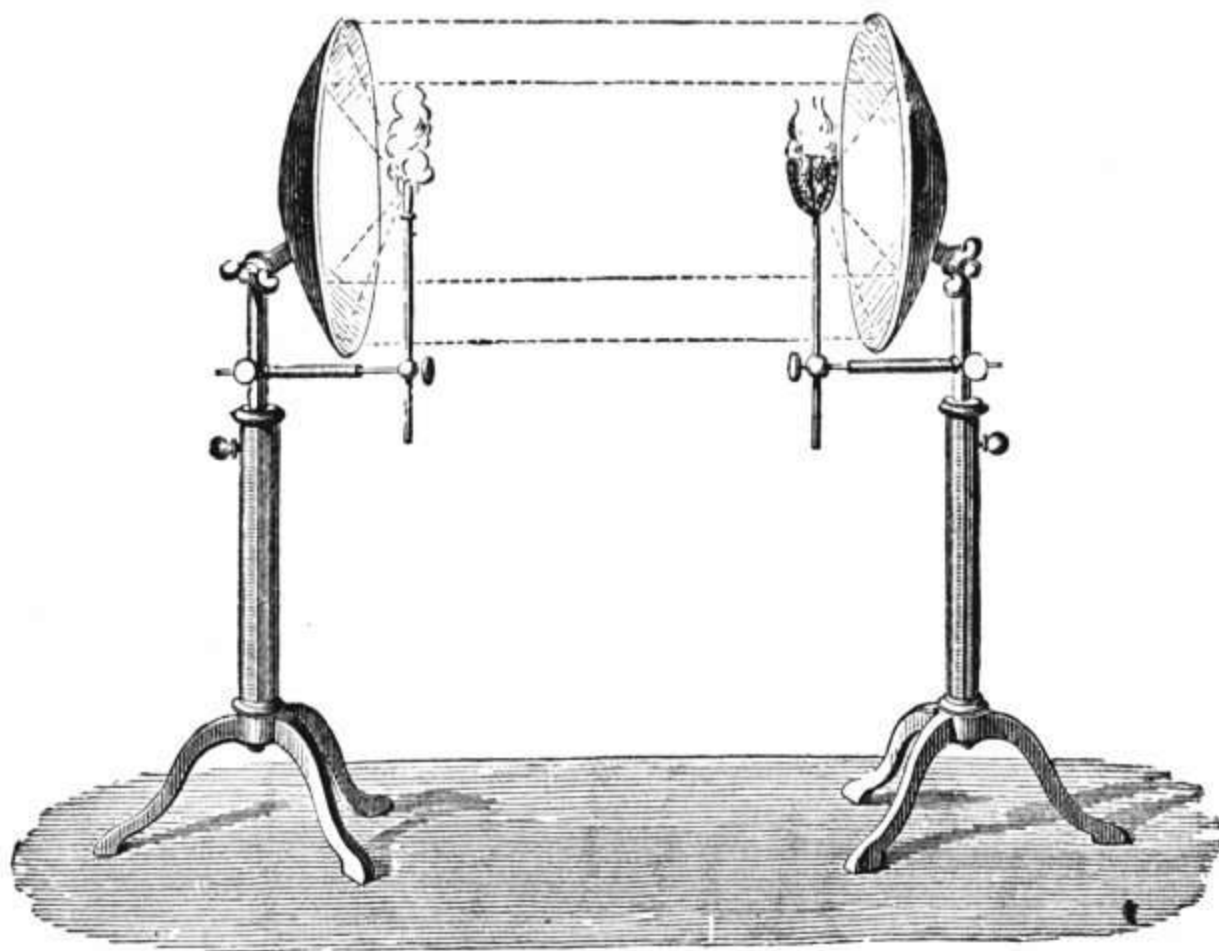

4983.

4982. <b>Pair of Parabolic Reflectors</b> , of copper, nickel plated, thirteen inches in diameter, mounted upon elevating and adjusting stands of mahogany and brass, with ball and holder, and phosphorus cup. Made exceedingly accurate.....	35 00
4983. <b>Pair of Parabolic Reflectors</b> , of silvered copper, twenty inches in diameter, mounted upon mahogany and brass elevating and adjusting stands, with ball and holder, and phosphorus cup... ..	60 00

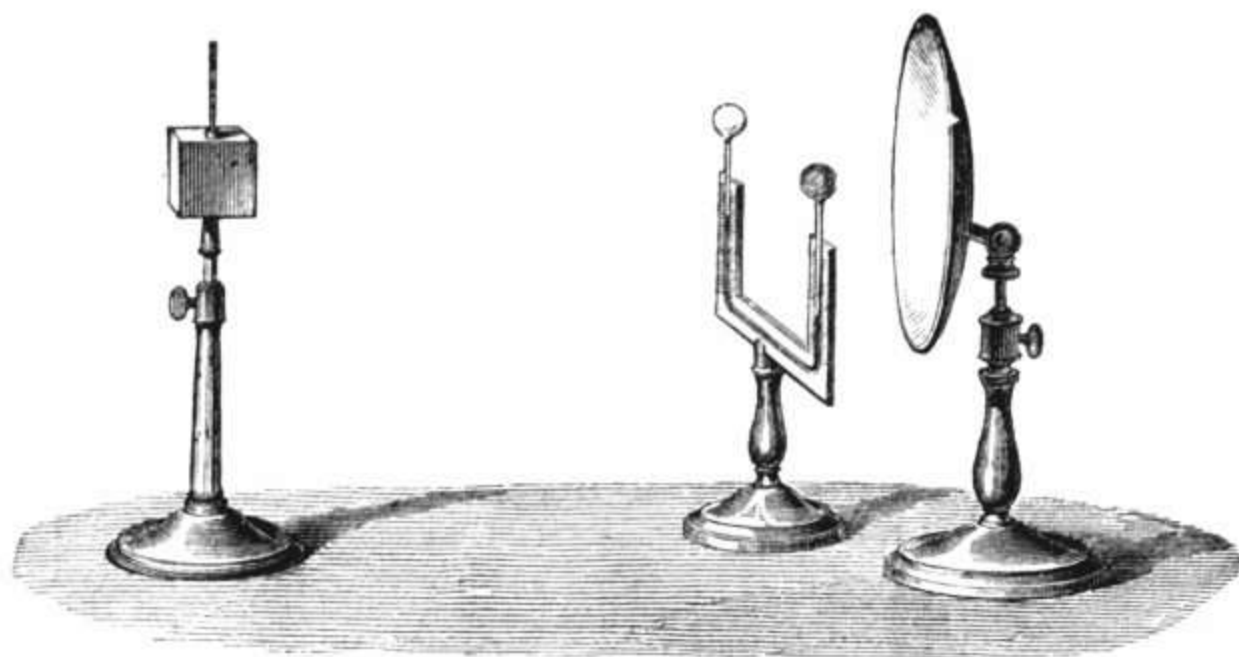

4984 and 4985.

- |   | PRICE   |
|---|---------|
| 4984. <b>Apparatus to Illustrate both Radiation and Reflection.</b> Consisting of a Leslie's cube, on adjusting stand of mahogany, a Leslie's differential thermometer, and a parabolic reflector, thirteen inches in diameter of planished tin, on a neat adjusting stand of mahogany..... | \$15 00 |
| 4985. Apparatus, same as No. 4984, but with parabolic reflector of nickel-plated copper, thirteen inches in diameter .....  | 22 00   |

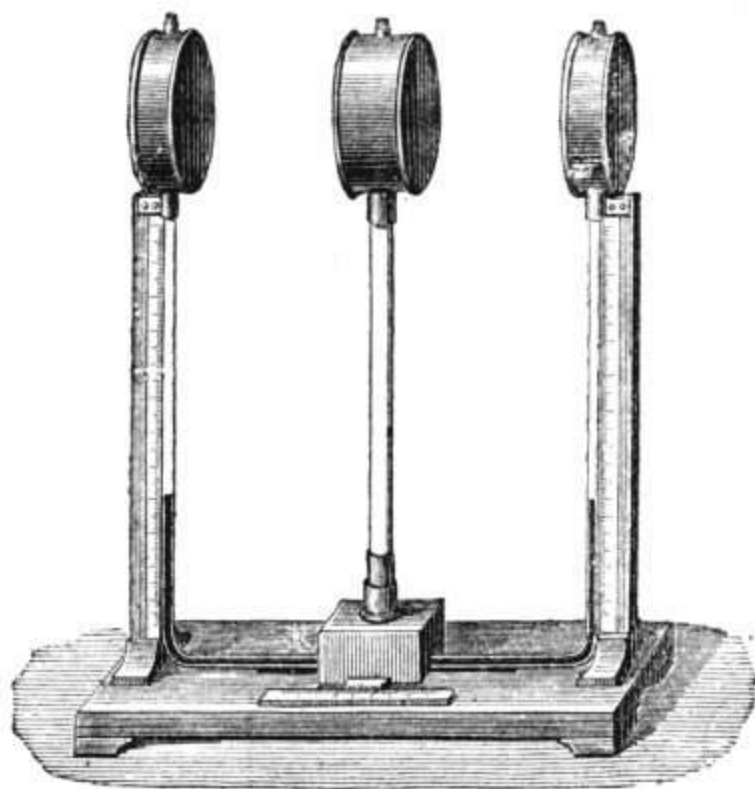

4986.

- |  |       |
|--|-------|
| 4986. <b>Ritchie's Apparatus.</b> To show the relation of radiation and absorption. Consisting essentially of a differential thermometer, with reservoirs of metal, the face of one black with lampblack, that of the other covered with white paint. A stand carrying a cylindrical vessel is placed between the arms, and can be adjusted to any desired position. This vessel is filled with hot water, and has its face, which is opposite the reservoir with blackened face, covered with white paint, and that opposite the one covered with white paint blackened with lampblack. Thus, the radiation from the black surface is absorbed by the white, and vice versa ..... | 20 00 |
| 4987. <b>Burning Mirror.</b> of silvered glass, six inches in diameter, mounted on pivots on a brass frame, with a holder for the substances to be melted.   | 25 00 |
| 4990. <b>Lens of Glass.</b> six inches in diameter, to show refraction of heat; on a brass stand.....  | 10 00 |
| 4991. <b>Lens,</b> similar to No. 4990 but eight inches in diameter .....  | 13 00 |

	PRICE
4992. <b>Pair of Lenses</b> , four and a half inches in diameter, of short focus, mounted in brass cell, to be used with the oxyhydrogen or electric lamp, to show refraction of heat.....	\$16 00
4993. <b>Hollow Prism of Glass</b> , for bisulphide of carbon, to show refraction and dispersion of heat; large model.....	7 50
4994. <b>Solid Prism of Rock Salt</b> , for same purpose, in a neat case.....	10 00

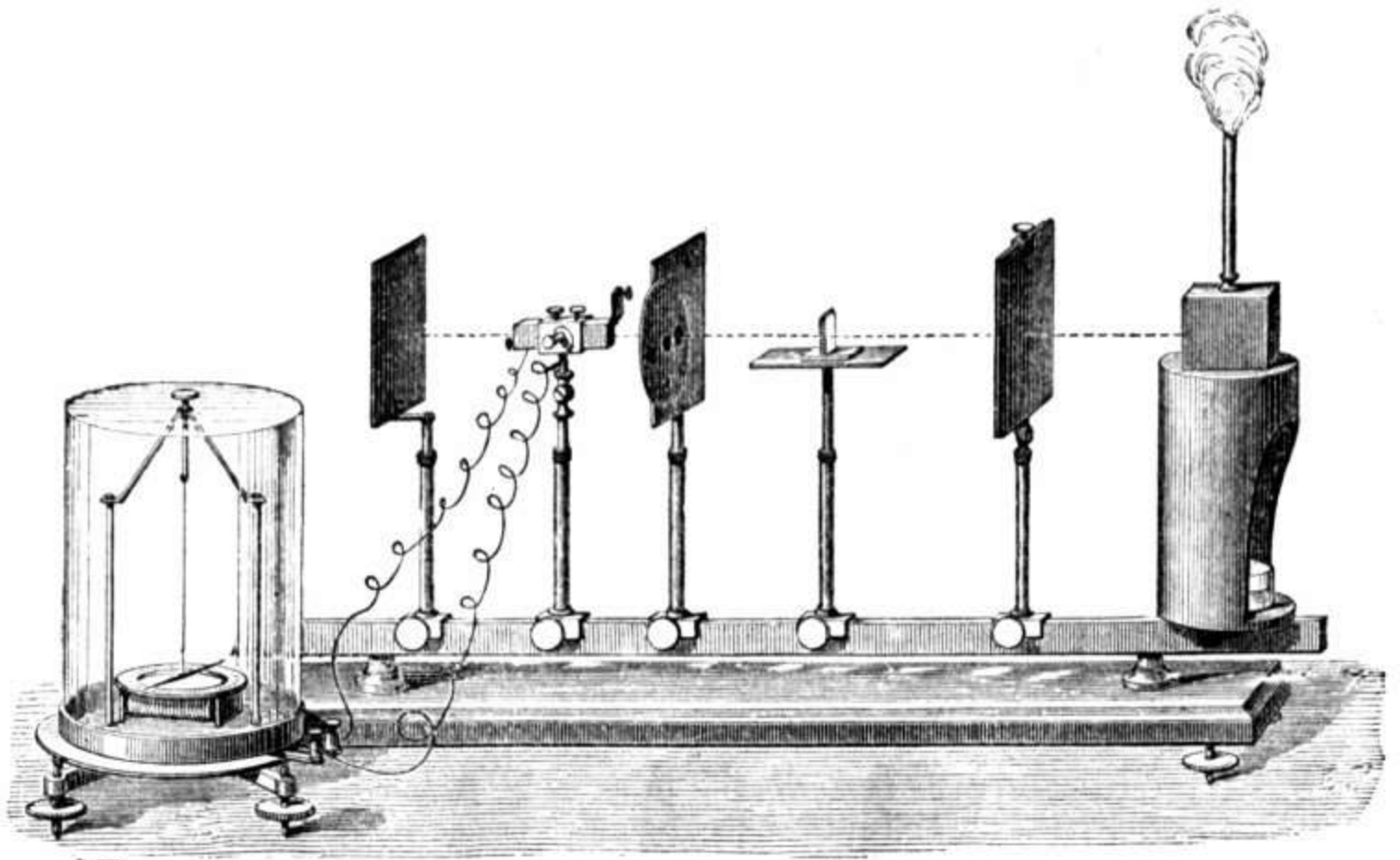

4995.

**4995. Melloni's Apparatus** for determining the laws of radiant heat, and the dia-thermancy of bodies.

This instrument consists of a graduated bar of brass, on a finely polished wooden base, with leveling screws; and carrying on elevating and adjusting posts of brass the following parts:

1. A Leslie's Cube, with shield and lamp.
2. Three screens for cutting off and limiting the amount of heat.
3. A table to carry the body whose dia-thermancy is to be tested.
4. A thermo-multiplier, No. 4964.

A delicate galvanometer, with leveling screws, accompanies the table.

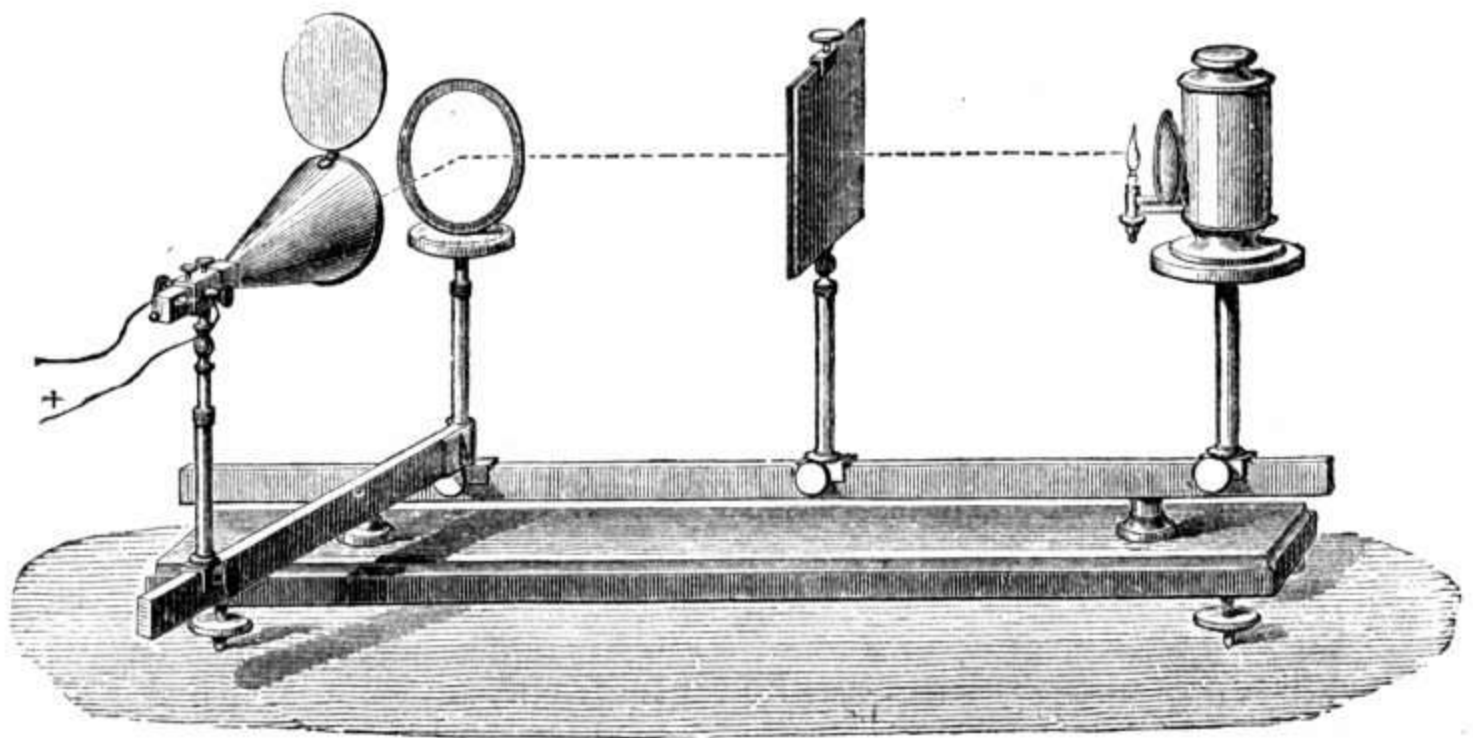

4996.

4996. **Melloni's Apparatus** for illustrating the laws of reflection, refraction, and diffusion. Consisting of the following additions to No. 4995:

1. A graduated arm of brass connected with the main bar of No. 4995 by a pivot and clamp.
2. A Locatelli lamp on stand.
3. A double screen on stand.
4. A stand with circular table graduated on the margin.
5. A silver reflector, burnished upon one side, but left unburnished upon the other.
6. A hollow prism for bisulphide of carbon.

Fig. 4996 shows the mode of arranging the thermo-multiplier and reflector.

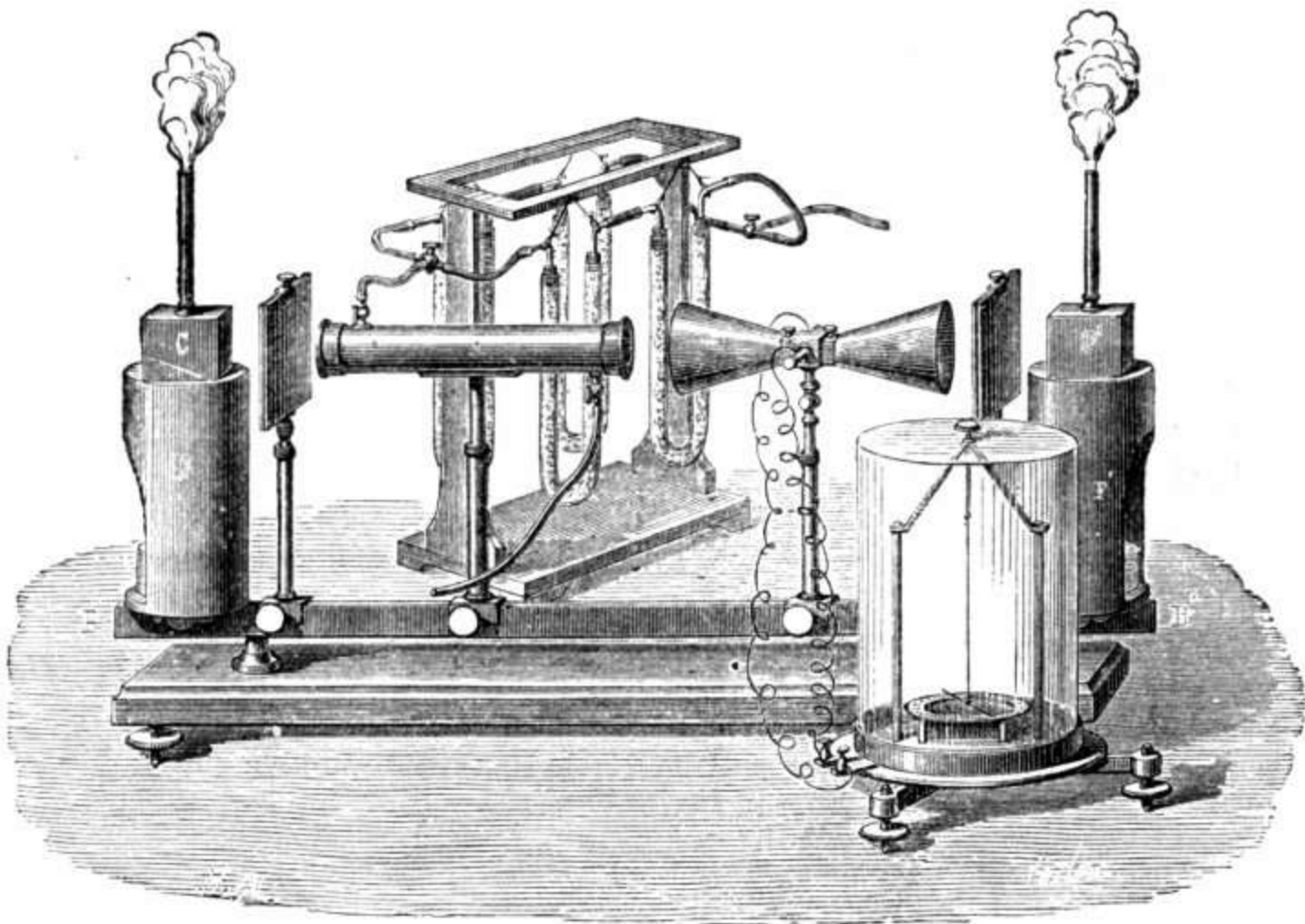

4997.

4997. **Tyndall's Addition to Melloni's Apparatus.** Consisting of a brass tube, with caps of rock salt, and entrance and exit tubes for gases; a series of four U tubes with the necessary stop-cocks, mounted on a neat mahogany frame, and an additional Leslie's cube, with clamp and shield, and a double screen. The mode of using is shown in the cut.....

\$85 00



5000.

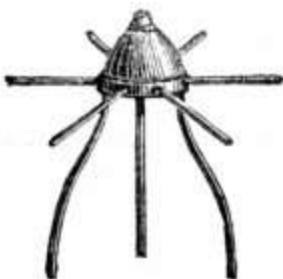

5001.

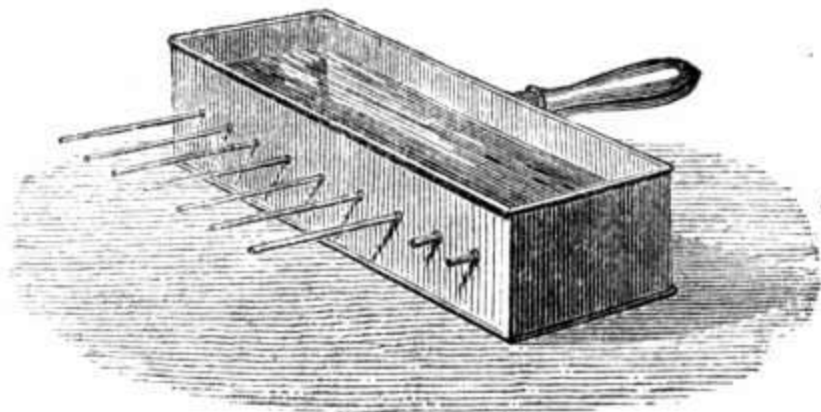

5002.

	PRICE
5000. <b>Conductometer.</b> Brass disc, with wooden handle, and six bars of different material, with cups for phosphorus.....	\$2 00
5001. <b>Conductometer.</b> Brass disc, on tripod stand, with six bars of different material, with cups and a lamp for heating.....	3 00
5002. <b>Conductometer of Ingenhouse.</b> A tank of copper, fifteen inches long, three wide and two deep, with nine flanges, and rods of different substances, and cups for phosphorus.....	5 00
5003. <b>Jamin's Ingenhouse Conductometer.</b> Similar to No. 5002, but with cover, feet and lamp.....	10 00

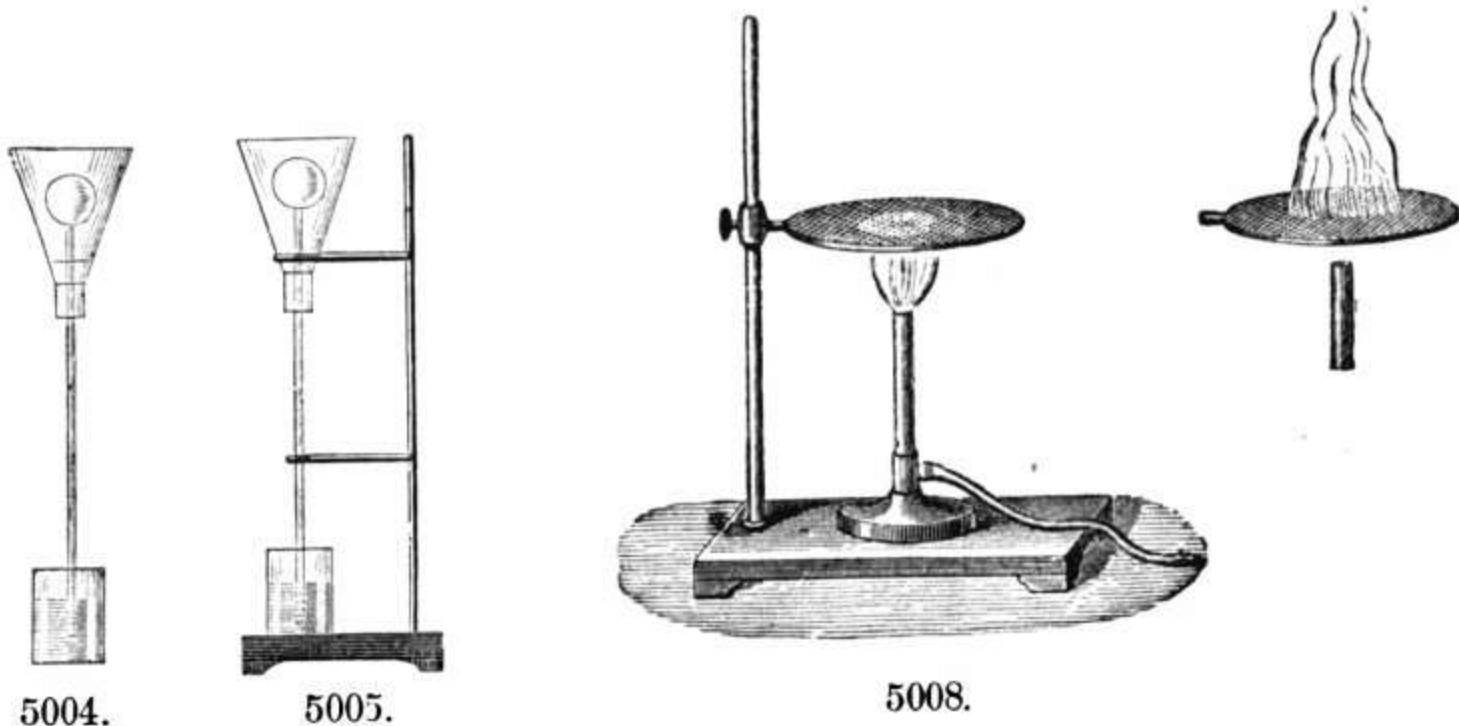

5004. <b>Apparatus to show the Weak Conducting Power of Water.</b> Glass funnel, air thermometer, and glass beaker.....	1 25
5005. <b>Apparatus, &amp;c.,</b> same as No. 5004, but mounted on neat stand.....	3 50
5007. <b>Wire Gauze.</b> Four inches square, with handle.....	50
5008. <b>Wire Gauze.</b> Four inches in diameter, on stand, with Bunsen burner.	3 75

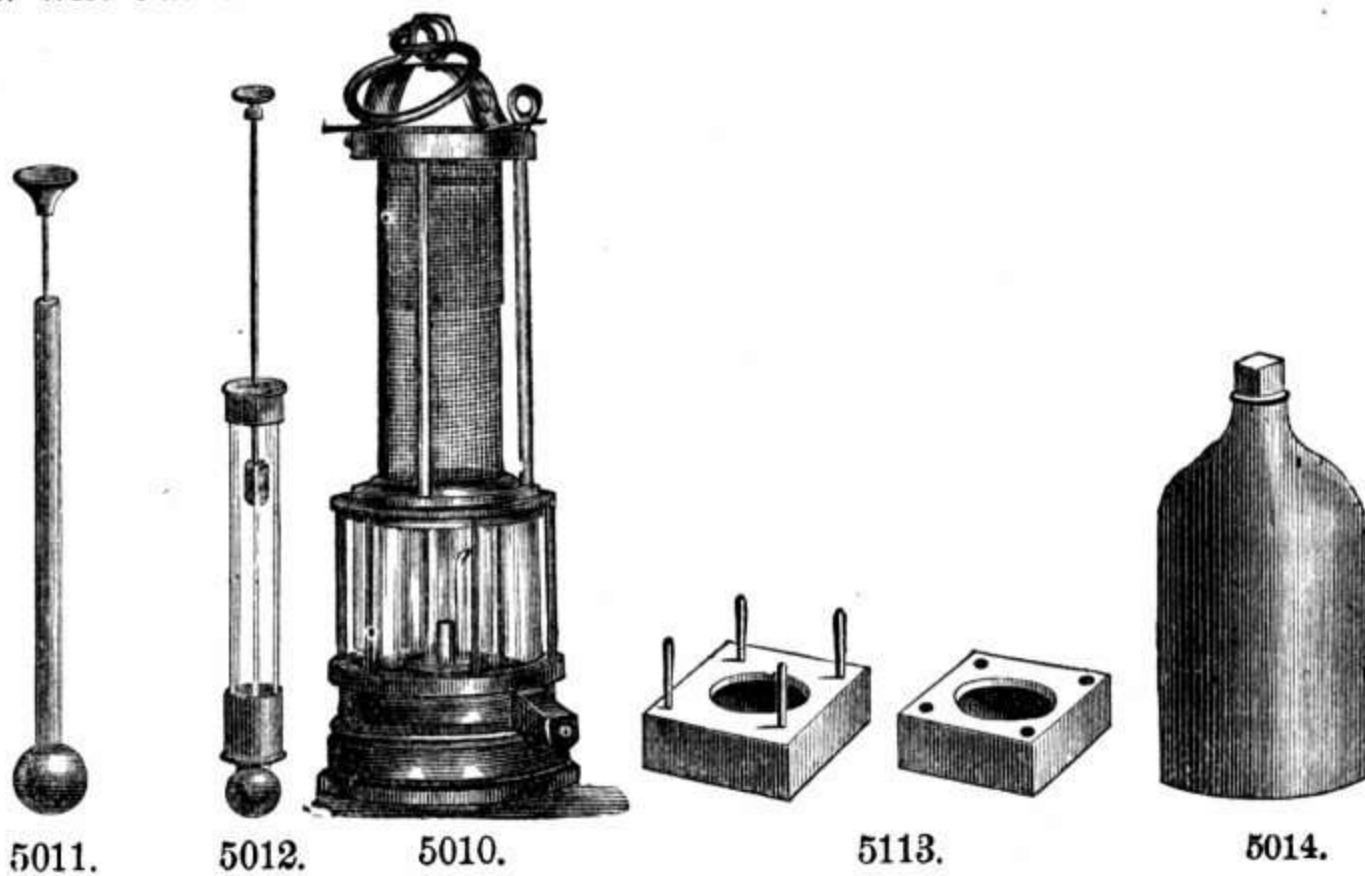

5010. <b>Davy's Safety Lamp.</b> Miner's model.....	4 00
5011. <b>Air Syringe.</b> Brass tube and piston, with box of tinder.....	2 00
5012. <b>Air Syringe.</b> Strong glass tube and piston, with box of tinder.....	6 00

INSTRUMENTS ILLUSTRATING THE PHENOMENA OF VAPORIZATION. 65

	PRICE
5013. <b>Set of Boxwood Moulds</b> , to use in showing the phenomenon of regelation. Spherical, cylindrical, and lenticular forms.....	\$7 50
5014. <b>Cast-Iron Bottles</b> . With screw top, to show the expansive power of water in freezing. Each.....	4 00

SECTION V.—OF INSTRUMENTS ILLUSTRATING THE PHENOMENA VAPORIZATION.

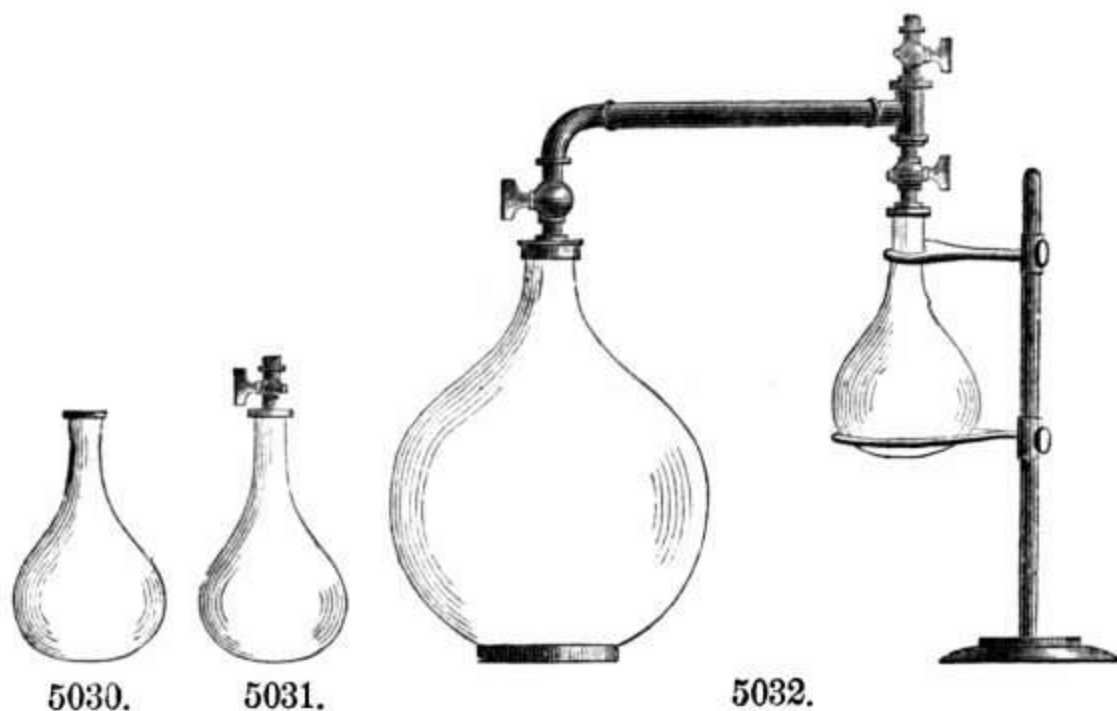

5030. <b>Culinary Paradox</b> . A glass flask, capacity one quart, with cork. . . .	60
5031. <b>Culinary Paradox</b> . A glass flask, capacity one quart, with brass cap and stop-cock.....	3 50
5032. <b>Culinary Paradox</b> . A glass flask, with brass cap and stop-cock. A larger flask is connected with this by a metal tube, and a pair of stop-cocks, placed as shown in the cut, permits the large flask to be exhausted by the air-pump.....	15 00

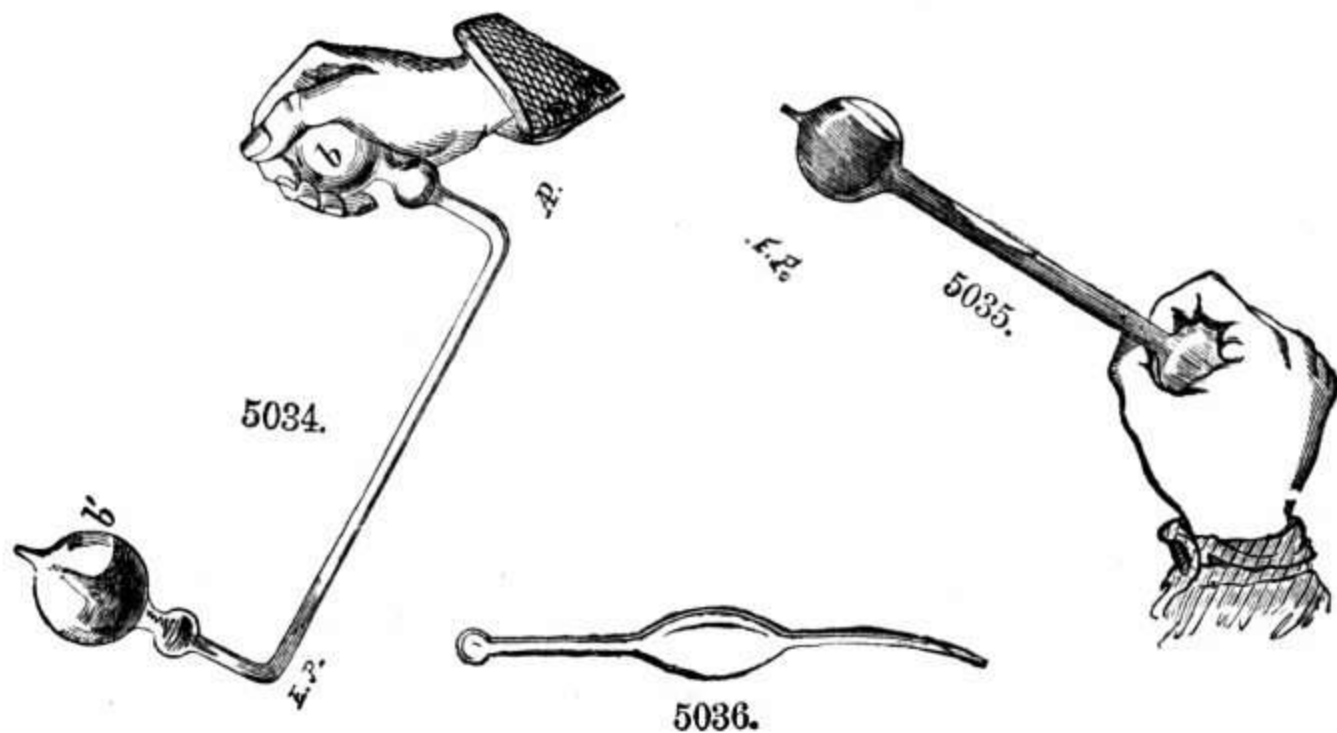

5033. <b>Palm Glass</b> .....	75
5034. <b>Franklin's Pulse Glass</b> .....	75
5035. <b>Pulse Glass</b> , with straight stem.....	75
5036. <b>Eolipile, or Ether Jet</b> . Of glass.....	25
5037. <b>Cryophorus</b> .....	2 00

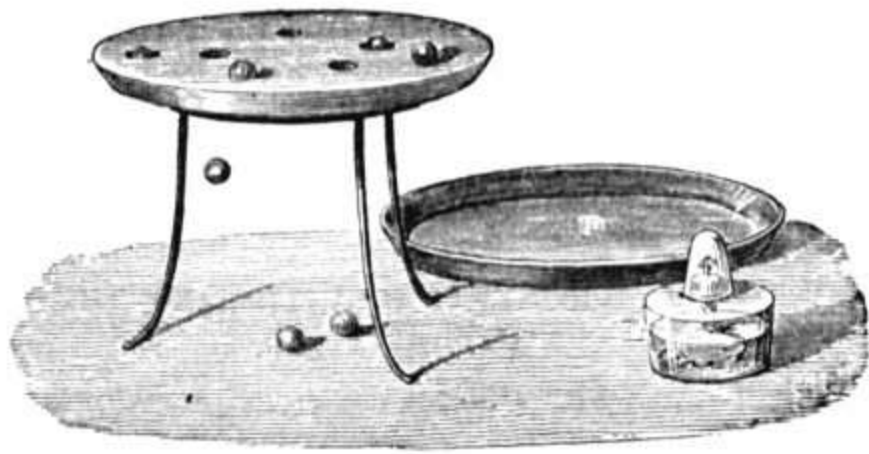

5038.

5038. **Tyndall's Apparatus for Specific Heat.** Consisting of a metal stand and ring for supporting a plate of wax. A dish for moulding the wax, and a lamp for melting it, two cakes of wax, three-eighths of an inch in thickness, and a series of seven balls, accompany the instrument .....

PRICE

\$3 00

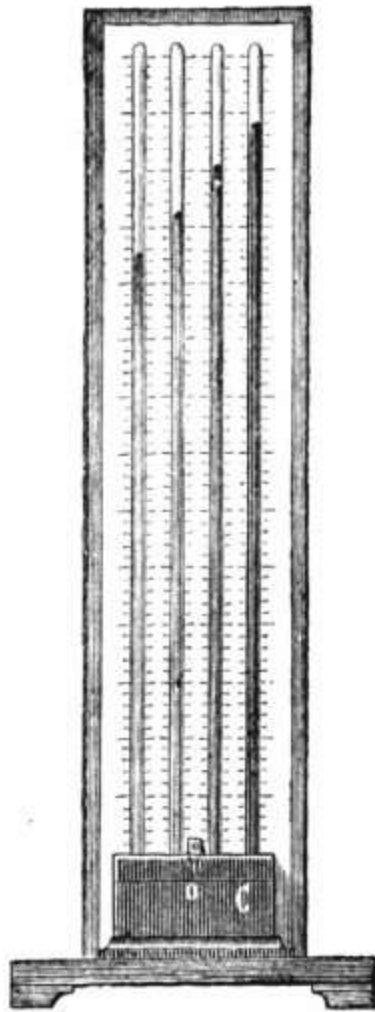

5041.

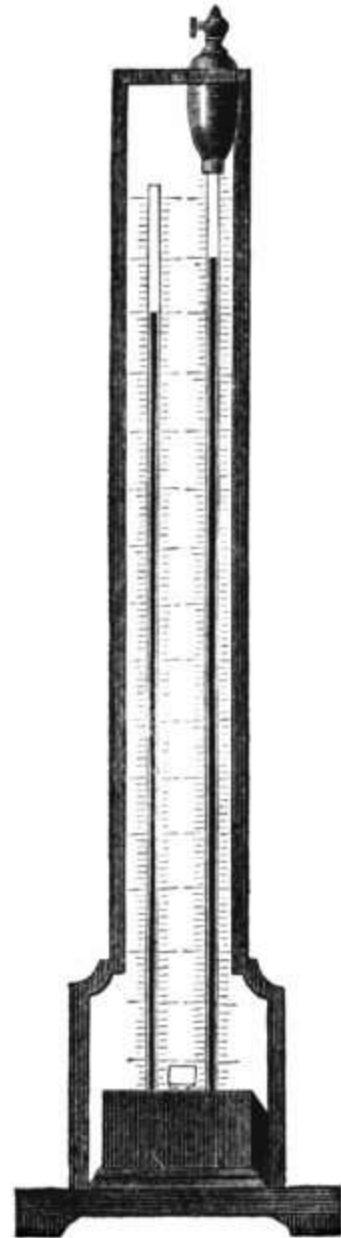

5043.

5041. **Apparatus to show the Unequal Tension of Different Vapors.** A cistern of iron, and four strong barometer tubes of glass, securely mounted upon a mahogany frame.....

12 00



PRICE

5042. **Barometer, with deep Cistern**, to show that the Law of Mariotte applies to Non saturated Vapors. Cistern of iron, with glass top, mounted on a neat iron tripod. An ordinary barometer tube supported from one side of the tripod stand, is attached..... \$10 00
5043. **Apparatus of M. Pouillet**, to show that the Tension of Vapor increases with the degree of saturation. A vase of iron for mercury, an ordinary barometer tube of glass, and a second tube, to the upper end of which a metallic vessel, with stop-cock, is cemented. All securely fastened to a neat, but strong stand of wood..... 17 00

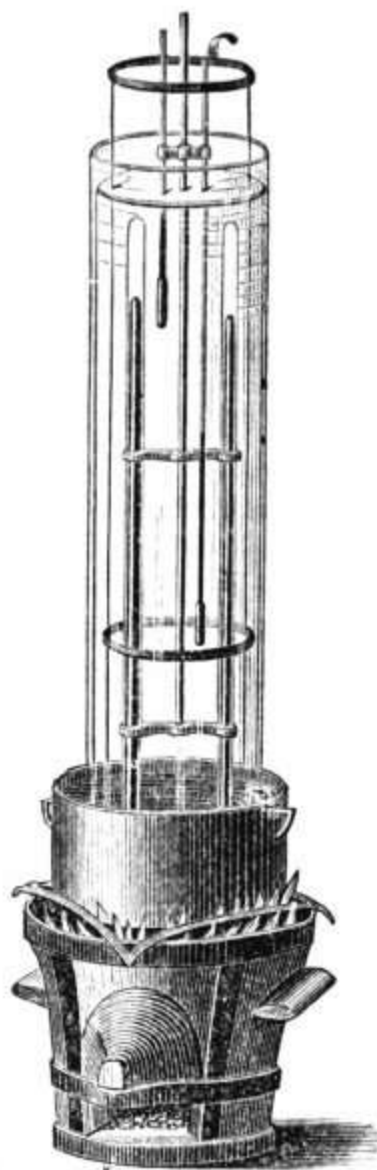

5045.

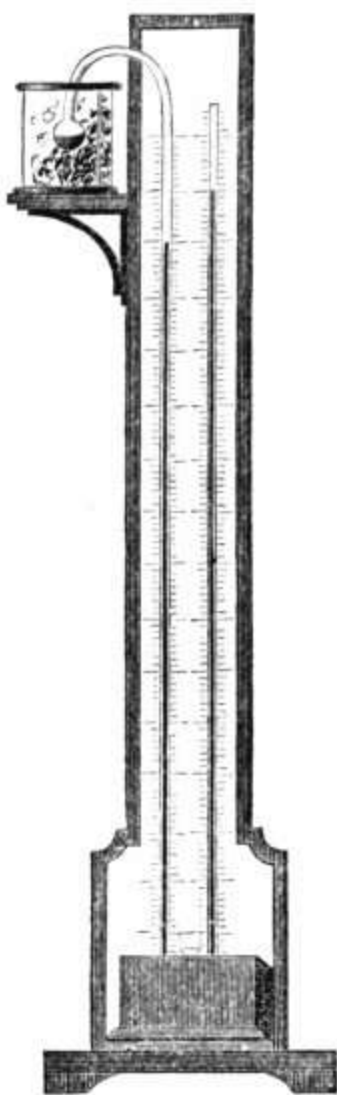

5046.

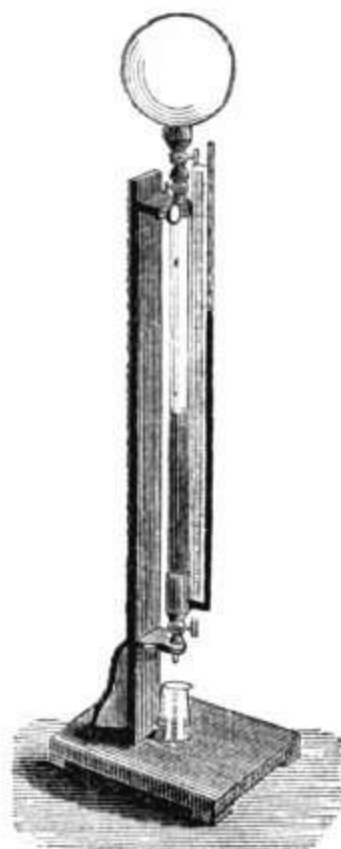

5047.

5045. **Dalton's Apparatus**. To measure the tension of the vapor of water between  $0^{\circ}$  and  $212^{\circ}$ . Consists of an iron reservoir for mercury, a glass tube three or four inches in diameter, and thirty-six inches high, for water; two barometer tubes, and two thermometers, on a strong frame. The whole is supported by a stout frame, and rests on a strong furnace for charcoal; or on a heavy iron base when Bunsen burners supply the place of a furnace. With the furnace.. 30 00
5046. **Gay Lussac's Apparatus**. To measure the tension of the vapor of water below  $0^{\circ}$ . Consisting of an iron reservoir for mercury, and two strong glass barometer tubes, supported on a neat mahogany frame. One of these is an ordinary tube, the other is recurved at the upper end, and terminates in a ball, which is surrounded, in performing the experiment, with a freezing mixture..... 15 00

5047. **Apparatus of Gay Lussac and Thenard.** To measure the tension of vapors mingled with gases..... \$27 00

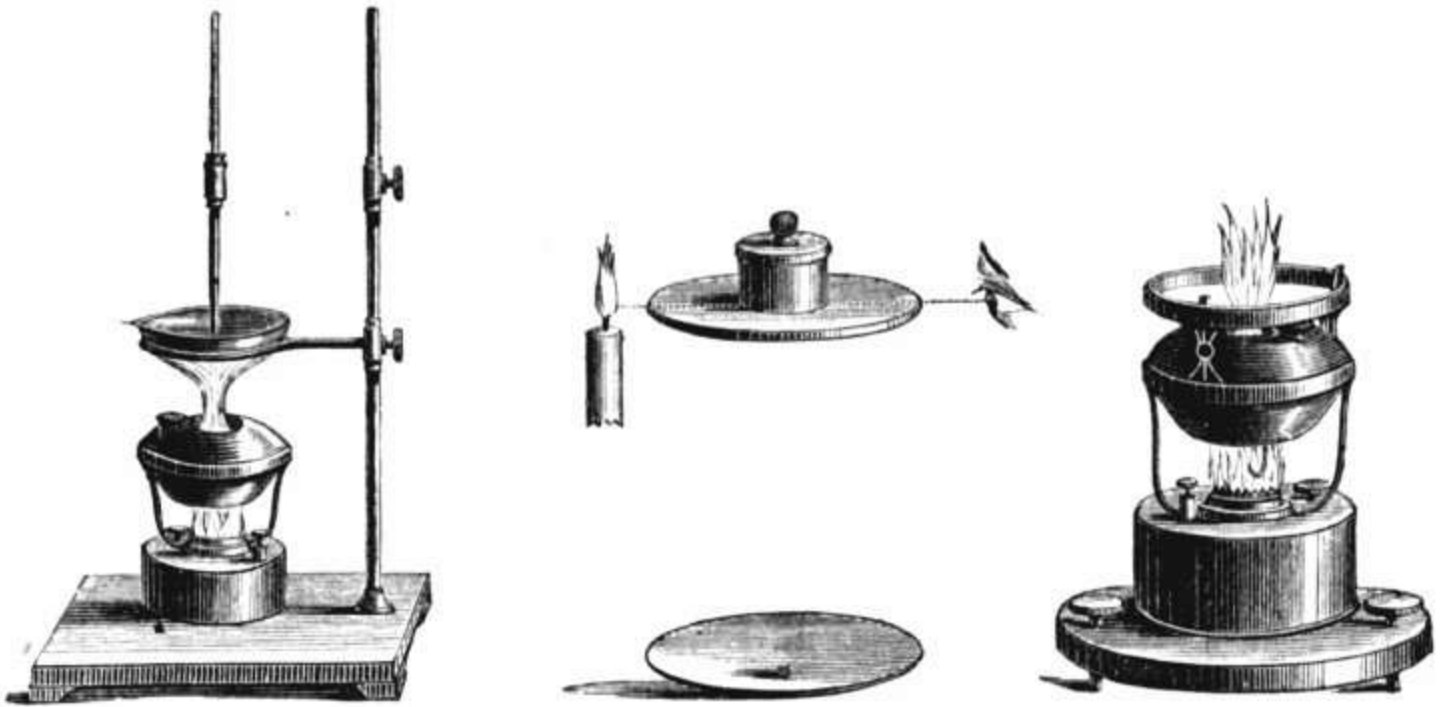

5055.

5055. **Apparatus of M. Boutigny.** For experiments upon the spheroidal state of liquids. Consisting of a blast-lamp with vertical jet, on a table, with leveling screws, and a table to hold the various plates, etc., as follows:

1. A silvered plate slightly hollowed.
2. A silvered cup, pierced with small holes.
3. A silvered plate, perfectly plain, and a silvered cylinder, cut away on opposite sides at one end.
4. A silvered basin, furnished with a thermometer, to show the temperature of the fluid during the spheroidal state.....

50 00

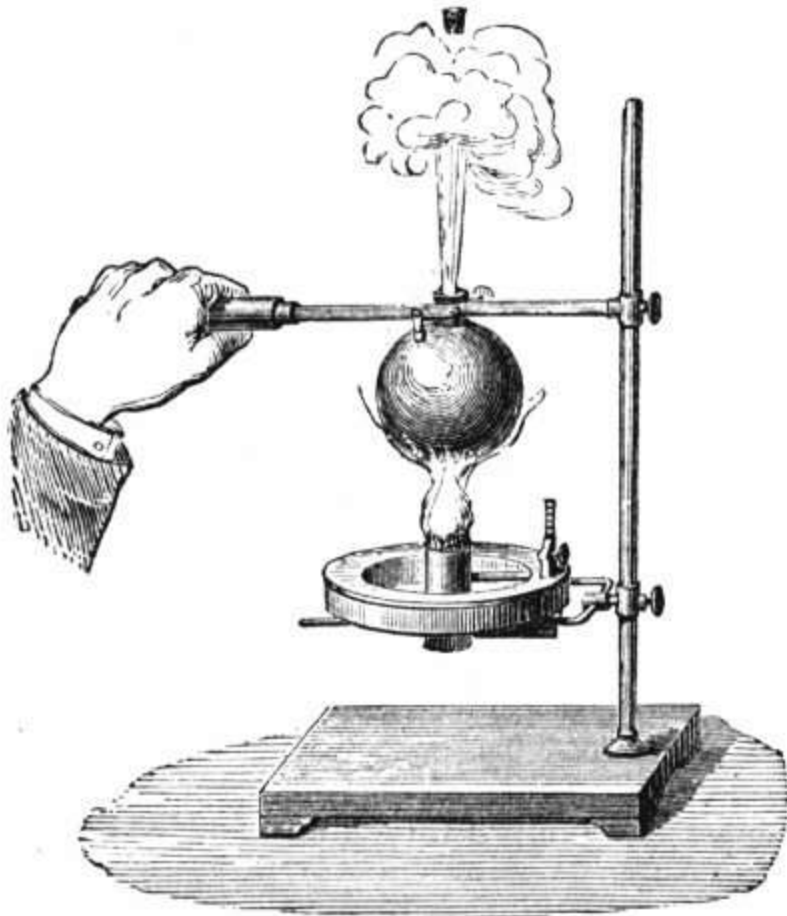

5056.

5056. **Copper Vessel,** to show spheroidal state. With lamp supported on stand as shown in the cut..... 12 50

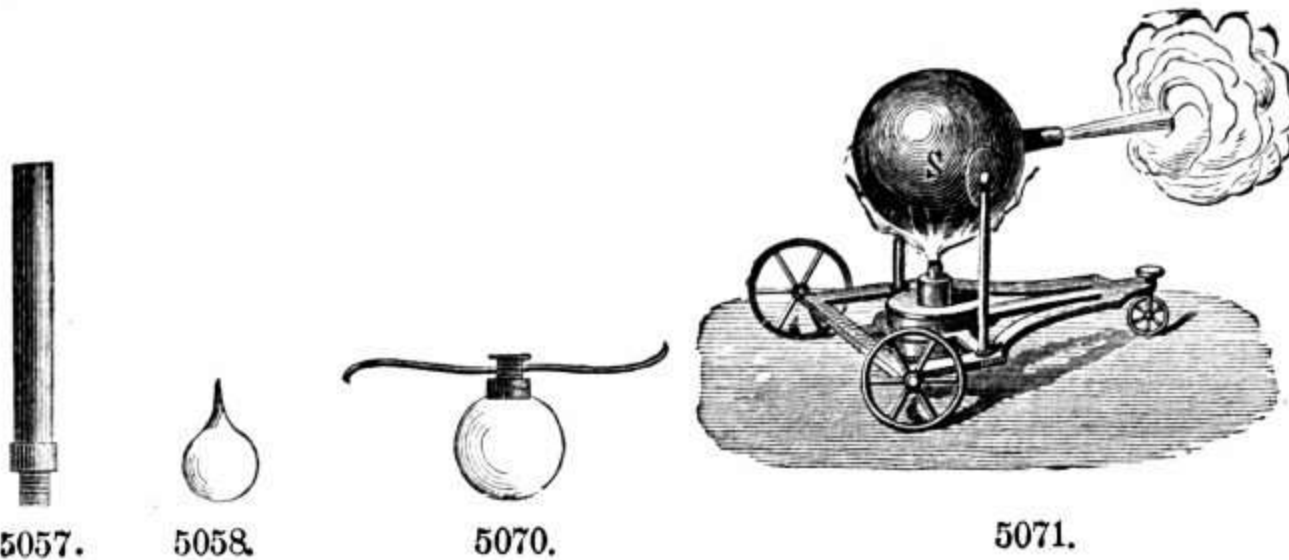

	PRICE
5057. <b>Tube of Copper.</b> Five inches long, to screw to the whirling table, No. 4078, and a pair of wooden jaws, to illustrate the boiling of water by friction, insulated by hard rubber.....	\$5 00
5058. <b>Candle Bombs.</b> Per dozen.....	50

SECTION VI.—THE STEAM ENGINE.

5070. <b>Hero's Engine.</b> Of brass, with curved arms on a swivel joint.....	4 25
5071. <b>Hero's Engine.</b> With straight jet, mounted, with lamp, on a neat car.	8 00

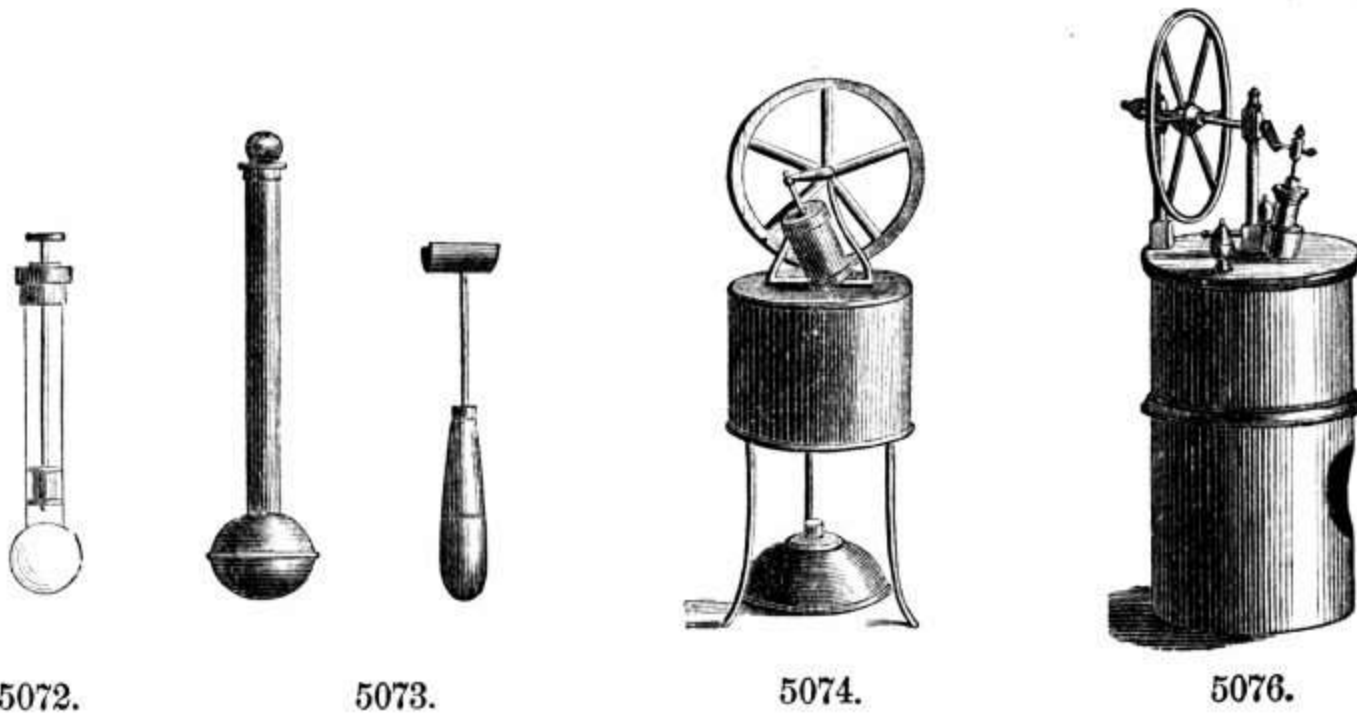

5072. <b>Wollaston's Illustration of a Low-pressure Engine.</b> Of strong glass.	1 50
5073. Same as No. 5072, but of brass, with safety valve, and handle with spring holder.....	4 00
5074. <b>Working Model of High-pressure Engine.</b> On tripod, with <i>tin</i> boiler, oscillating cylinder and lamp.....	3 00
5075. <b>Working Model of a High-pressure Engine.</b> On tripod, with <i>brass</i> boiler, oscillating cylinder, lamp, and low-water gauge.....	5 50
5076. <b>Working Model of a High-pressure Engine,</b> all of brass, on a neat brass stand, with oscillating cylinder, and lamp.....	10 00
5077. <b>Working Model,</b> same as No. 5076, but with low-water gauge.....	11 00

5078. **Working Model of High-pressure Engine.** Of brass, with detached boiler of copper, ten inches long and four inches in diameter, with safety-valve, high and low water gauges, connecting pipe, with stop-cock to shut off steam from the boiler, brass fly-wheel five inches in diameter, and driving-wheel on end of crank to permit the attachment of light articles for rotation.....

\$40 00

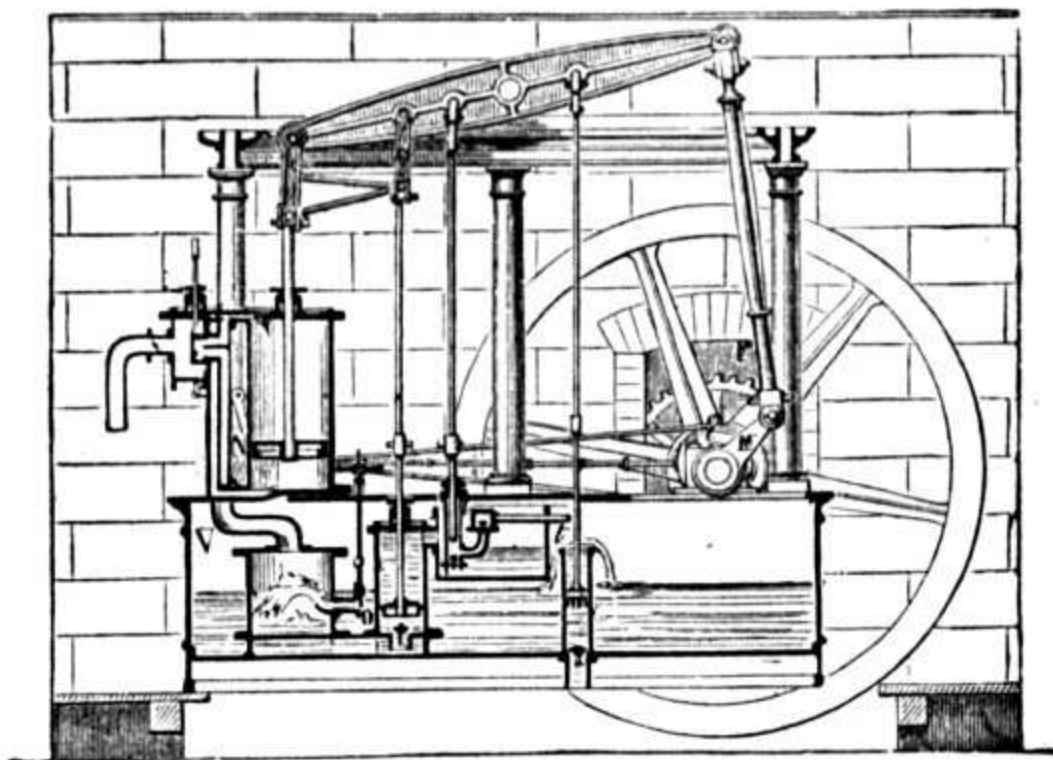

5095.

5095. **Sectional Model of Watts' Engine.** Of strong card-board. Showing all the interior valves and details of construction. Moved by a crank at the back.....

10 00

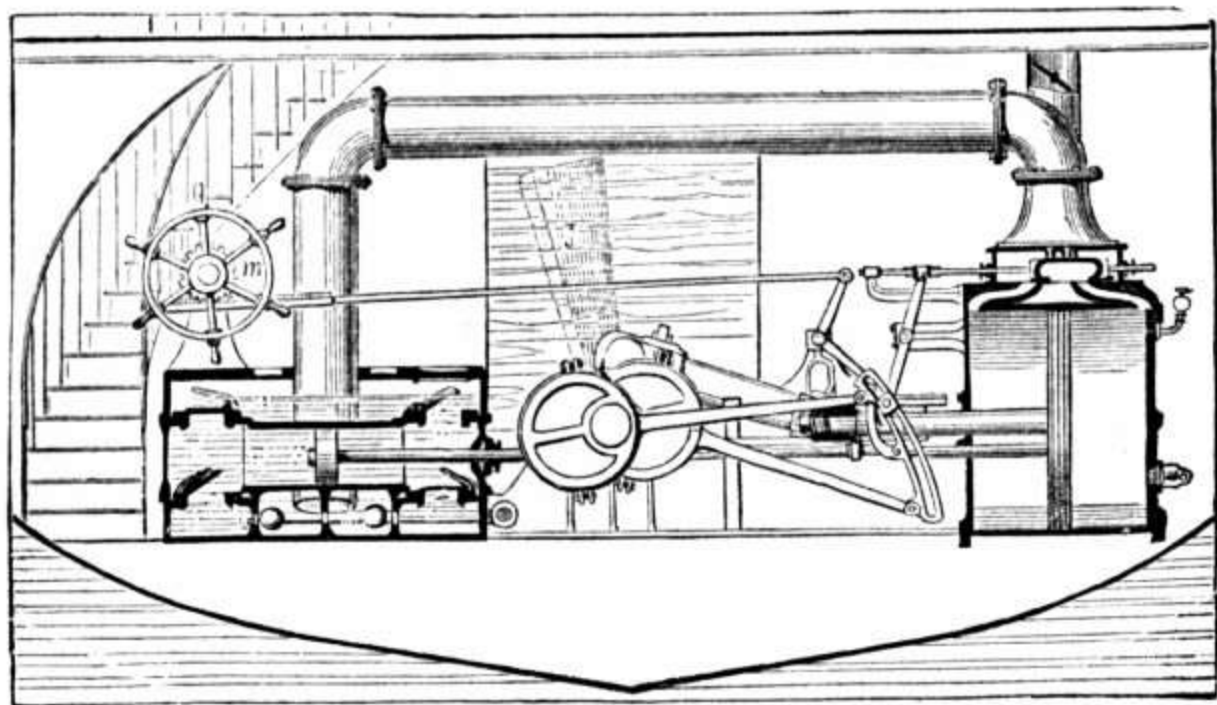

5096.

5096. **Sectional Model of a Marine, Side-wheel Engine.** Of strong card-board, showing all the interior valves and details of construction. Moved by a crank at the back.....

12 00

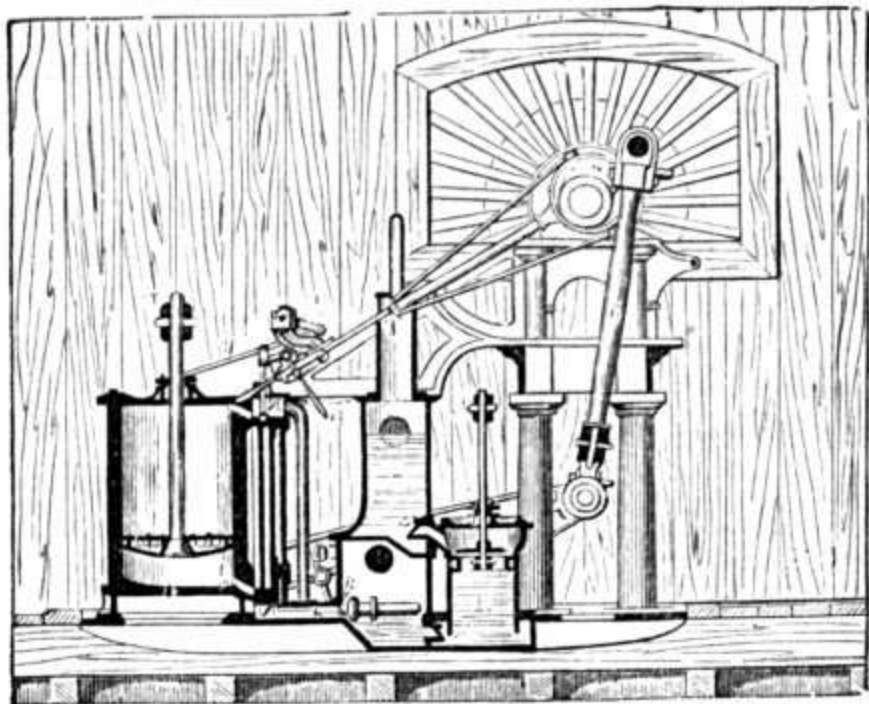

5097.

5097. Sectional Model of a Marine Engine, with Screw Propeller. Of strong card-board, showing all the interior valves and details of construction. Moved by a crank at the back ..... PRICE  
\$12 00

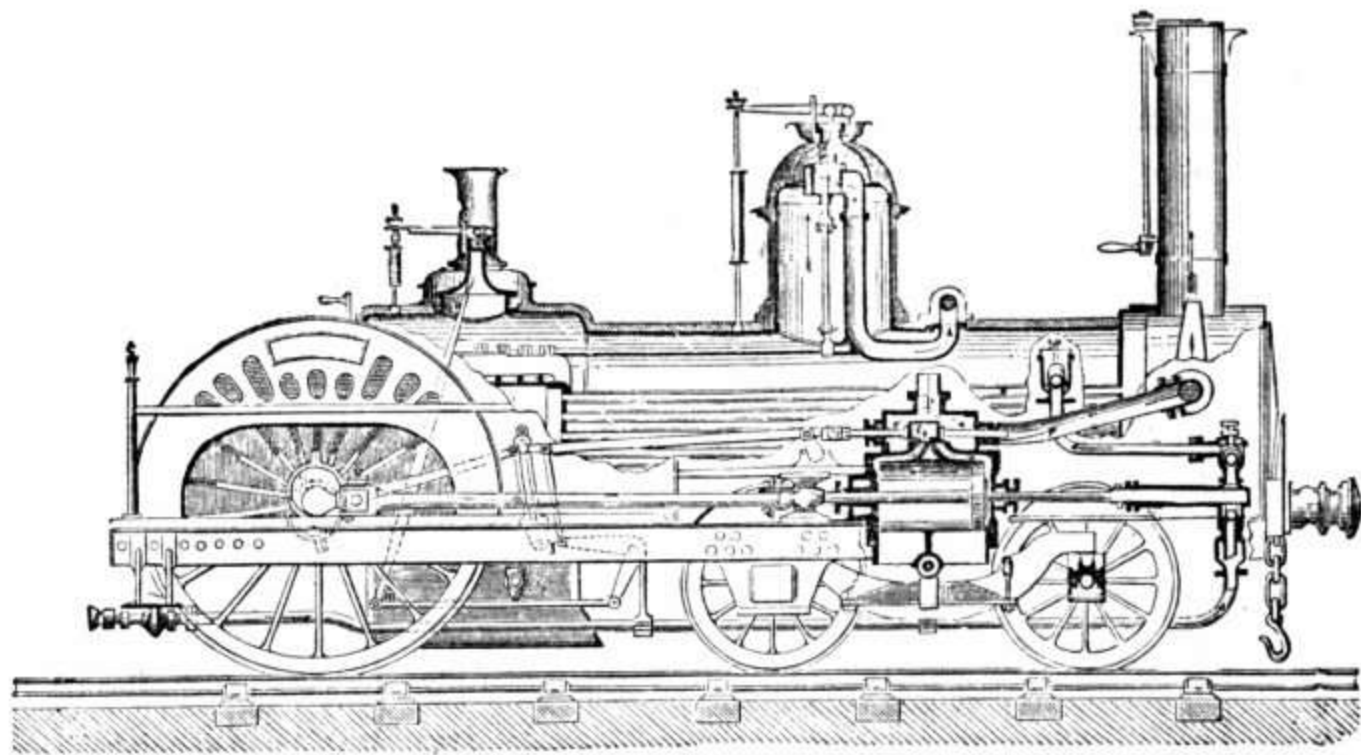

PEGARD

5098.

5098. Sectional Model of Locomotive Engine for high speed. Of strong card-board. Showing all the interior valves and details of construction. Moved by a crank at the back..... 12 00

SECTION VII.—HYGROMETERS.

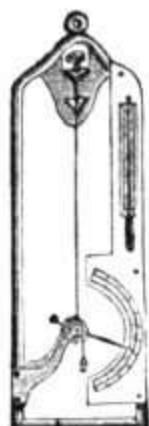

5110.

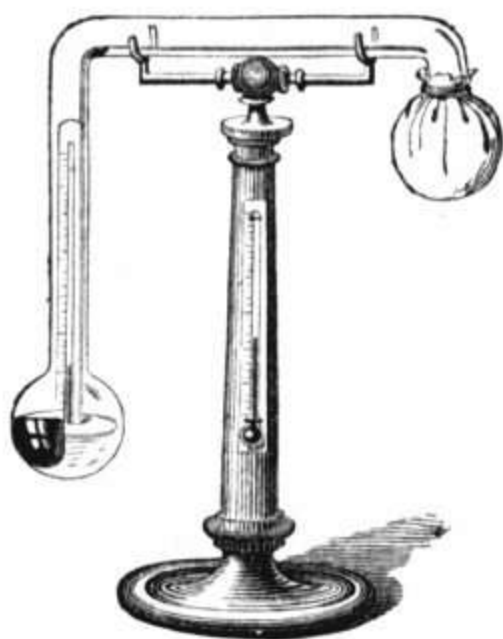

5111.



5112.

	PRICE
5110. <b>Saussure's, or Hair Hygrometer.</b> Nine and a half inches high, on brass frame, with thermometer. Very neatly finished and inclosed in a strong wood case.....	\$15 00
5111. <b>Daniell's Hygrometer.</b> On brass base, with silvered metallic post. Whole instrument, eight inches high. In neat morocco case, lined with velvet.....	16 00
5112. <b>August's Psychrometer.</b> On neat brass stand, with brass arm for the thermometers, and holder for the water-cistern. Thermometers very delicate and accurate, graduated upon the tube to fifths of a degree Centigrade. The whole contained in a neat morocco case, lined with velvet .....	25 00

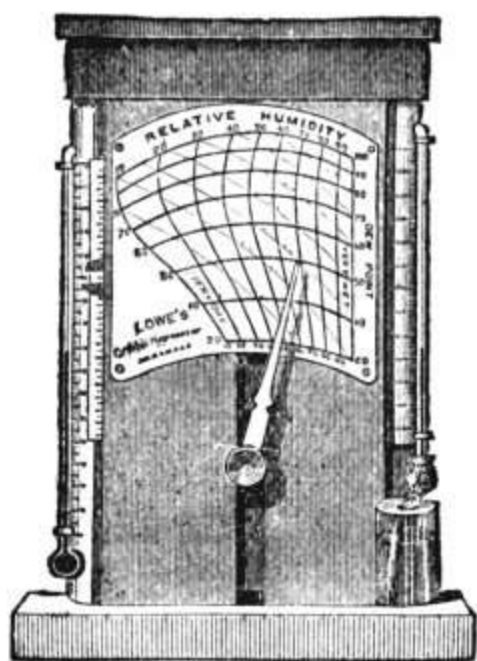

5117.

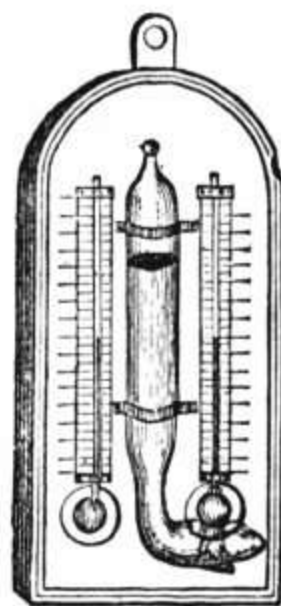

5119.

5117. <b>The Hygrodeik.</b> A very useful instrument for showing the actual temperature, the temperature due to evaporation, the relative amount of moisture, and the dew point, by adjusting the index on the dial. This instrument is especially suited for use in school-rooms and parlors. On a neat marble base .....	15 00
5118. <b>Rain Gauge.</b> Smithsonian style .....	5 00
5119. <b>Mason Hygrometer Boxwood Scales</b> .....	4 50
5120. <b>Opal Glass Scales,</b> in metal case.....	8 00

# ELECTRICITY.

## PART FIRST.

### CHAPTER VII.

#### APPARATUS FOR EDUCATIONAL PURPOSES AND DEMONSTRATION.

#### SECTION I.—INSTRUMENTS ILLUSTRATING THE FUNDAMENTAL PRINCIPLES OF ELECTRICITY.



5141.

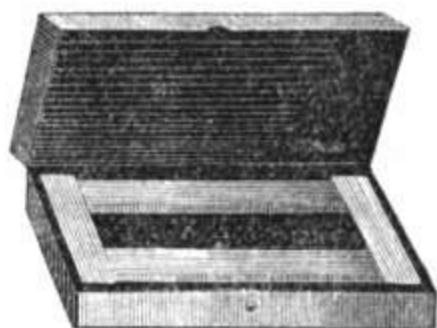

5143.



5146.



5148.

	PRICE
5138. <b>Lodestone, or Natural Magnet</b> .....	\$0 50
5139. <b>Lodestone.</b> Very strong, in brass frame, with rings.....	15 00
5141. <b>Bar Magnet.</b> Six inches long.....	50
5142. <b>Bar Magnets.</b> Pair, two inches long, to be used in projecting the "magnetic phantom"; in box, with armatures.....	2 50
5143. <b>Bar Magnets.</b> Pair, nine inches long, in neat wooden box, with armatures.....	3 50
5146. <b>Magnetic Needle.</b> Six inches long. On stand.....	2 00
5147. <b>Magnetic Needle.</b> Very superior, with agate centre.....	3 50
5148. <b>Magnetic Needle.</b> Fifteen inches long, suspended by a stirrup and cord from a brass stand.....	6 00



5149.



5150.

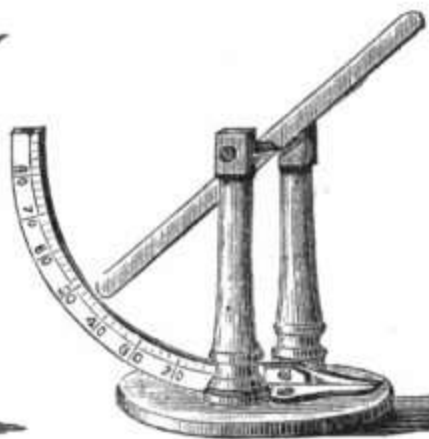

5151.

5149. <b>Dipping Needle.</b> Small Model. Needle, two inches long.....	2 00
5150. <b>Dipping Needle.</b> Large Model. Needle, twelve inches long, on universal joint, mounted on brass stand.....	6 00
5151. <b>Inclination Compass.</b> Graduated arc, needle three and a half inches long. Very delicate.....	8 00

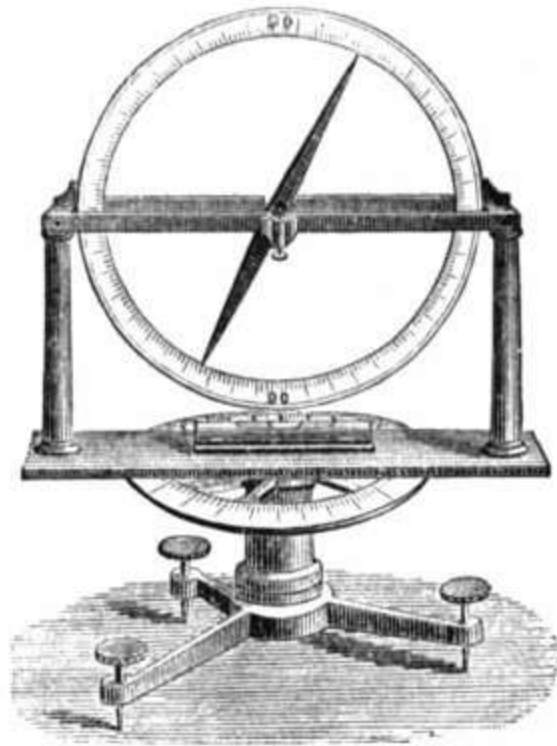

5152.

- |   | PRICE   |
|---|---------|
| 5152. <b>Inclination Compass.</b> Vertical circle, ten inches in diameter, horizontal circle, five inches; brass posts, base and leveling screws, all delicately finished ..... | \$50 00 |
| 5153. <b>Inclination and Declination Compass.</b> Needle on agate bearings, circles graduated on silver, 140 mm. diameter .....   | 25 00   |



5155.

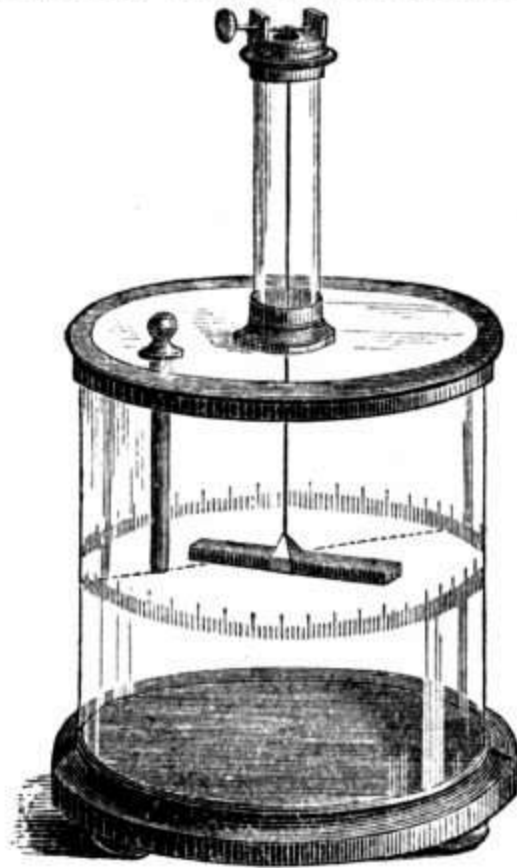

5158.

- |  |       |
|--|-------|
| 5155. <b>Astatic Needle.</b> Pair, six inches long, on a brass pivot and stand.                                | 2 00  |
| 5156. <b>Astatic Needle.</b> Pair, twelve inches long, supported by an untwisted cord from a brass stand ..... | 9 00  |
| 5158. <b>Torsion Balance.</b> Glass case, eight inches in diameter and ten inches high .....                   | 25 00 |
| 5159. <b>Coulomb Torsion Balance</b> (5158), with accessory parts for use as electrometer (5228).....          | 44 00 |



5171.	"	"	"	two inches long .....	10
5172.	"	"	"	two and one-half inches long.....	10
5173.	"	"	"	three inches long.....	15
5174.	"	"	"	three and one-half inches long.....	20
5175.	"	"	"	four inches long.....	25
5176.	"	"	"	four and one-half inches long .....	30
5177.	"	"	"	five inches long.....	35
5178.	"	"	"	five and one-half inches long .....	50
5179.	"	"	"	six inches long.....	60

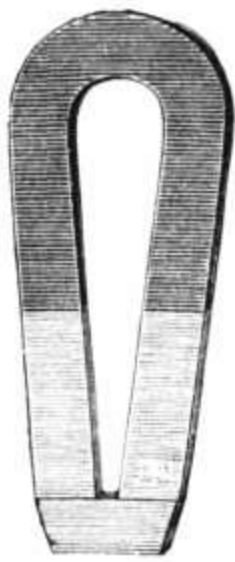

5170-81.

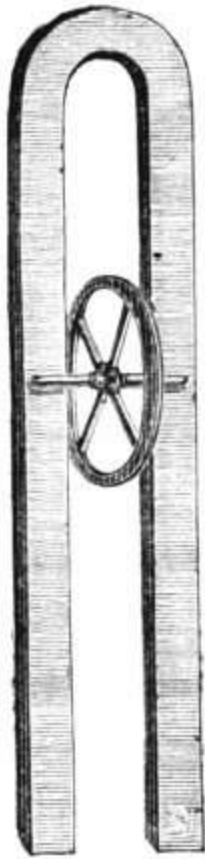

5186.

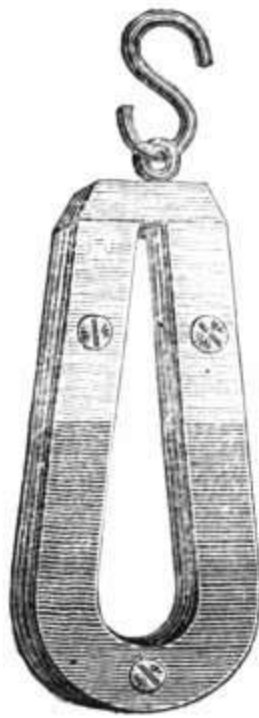

5187.



5190-5196.

					PRICE
5180.	<b>Horseshoe Magnet,</b>	seven inches long.....			\$ 75
5181.	"	eight inches long.....			1 00
5185.	"	ten inches long, very superior quality.....			1 75
5186.	"	ten inches long, with rolling armature.....			3 25
5187.	<b>Compound Horseshoe Magnet,</b>	four bars, four inches long.....			4 25
5188.	Compound Horseshoe Magnet,	four bars, five inches long.....			5 00
5189.	Compound Horseshoe Magnet,	four bars, six inches long .....			6 00

**JAMIN MAGNETS.**

*Composed of a number of strips fastened together, as per figure 5190-5196.*

No.	Thickness.	Length.	Wt. of Iron.	Wt. of Steel.	Total wt.	Weight it will carry.	
5190.	1. cm.	0.5 m.	.085 k.	.190 k.	.275 k.	3. k.....	6 60
5191.	2. 1. cm.	0.5 m.	.120 k.	.250 k.	.370 k.	5. k.....	9 00
5192.	3. 1.50 cm.	0.6 m.	.145 k.	.435 k.	.580 k.	10. k.....	10 40
5193.	4. 2. cm.	0.7 m.	.220 k.	.800 k.	1.020 k.	15. k.....	13 20
5194.	5. 3. cm.	0.8 m.	.350 k.	1.150 k.	1.500 k.	20. k.....	14 70
5195.	6. 4. em.	0.9 m.	.500 k.	1.650 k.	2.150 k.	25. k.....	16 50
5196.	7. 5. cm.	1.00 m.	1.870 k.	5.950 k.	7.820 k.	80. k.....	45 00

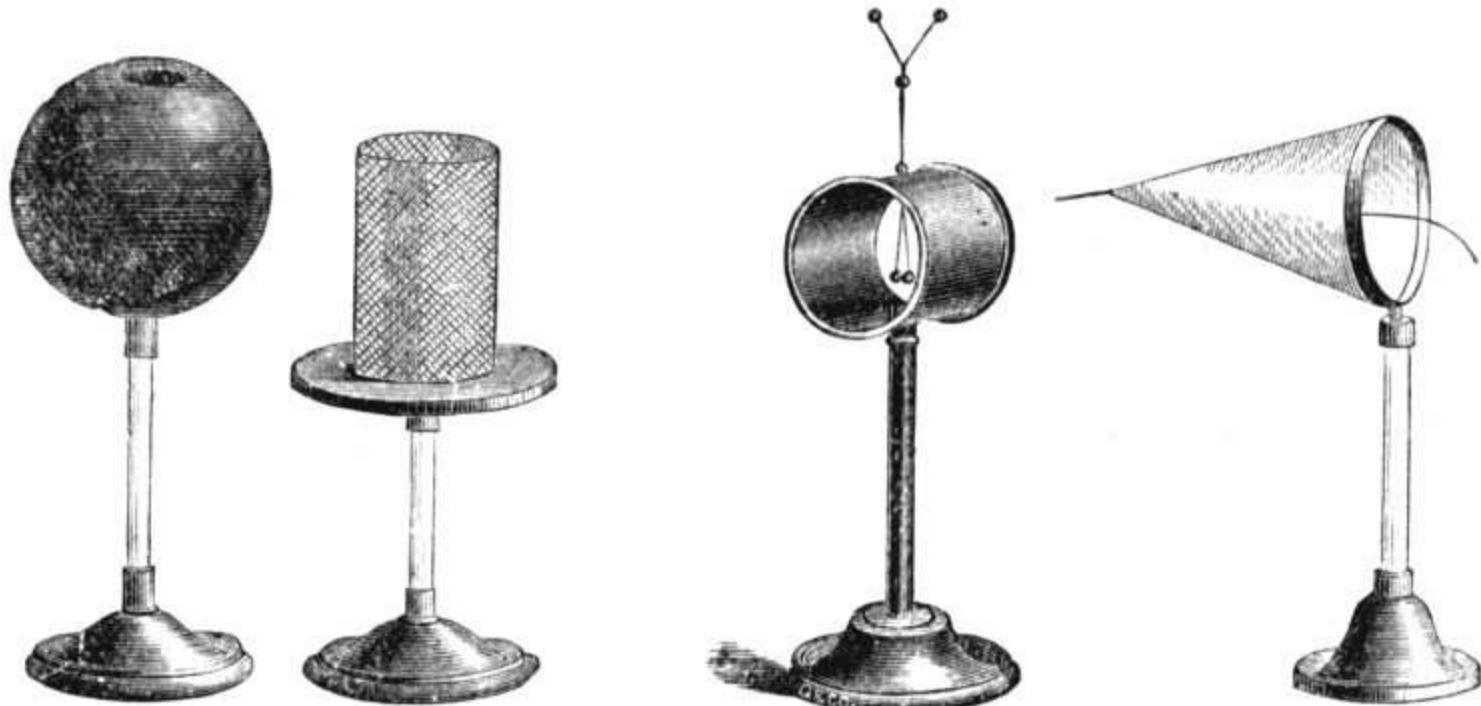

5216.	5217.	5218.	5219.	
5210. Pith Balls, per dozen.....				25
5211. Pith Balls, suspended by cords, each .....				10
5212. Glass Rod, for excitation, large.....				1 00
5213. Rod of Shellac, for excitation.....				1 25
5214. Rod of Vulcanite, for excitation.....				1 00
4215. Cat's Skin, for exciter.....				,75
5216. Hollow Sphere, five inches in diameter. To show that electricity resides only on the surface of bodies. On neat insulating stand, with proof plane.....				8 00
5217. Faraday's Wire Cylinder, on a polished, insulated brass plate.....				4 00
5218. "Hollow Cylinder," for showing that electricity resides only on the surface of bodies, and is intended to replace the old Biot's Hemispheres; of brass, neatly mounted rubber support.....				6 00
5219. Faraday's Bag, on insulated ring, six inches in diameter.....				4 00

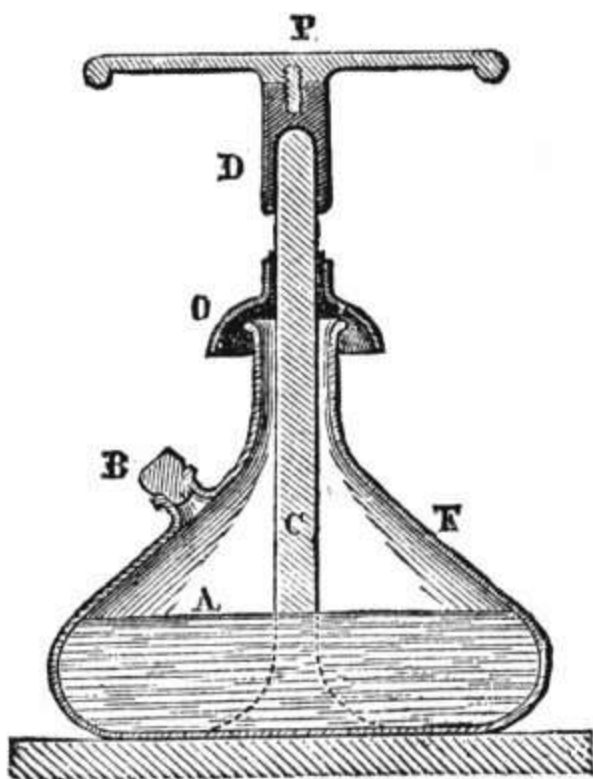

5220.

5220. New Insulating Support, by Mascart, with sulphuric acid (A). This support is almost indispensable for experiments in electricity. The electrified bodies are placed on the plate P or on the post D, preserving the charge.....	6 00
---	------

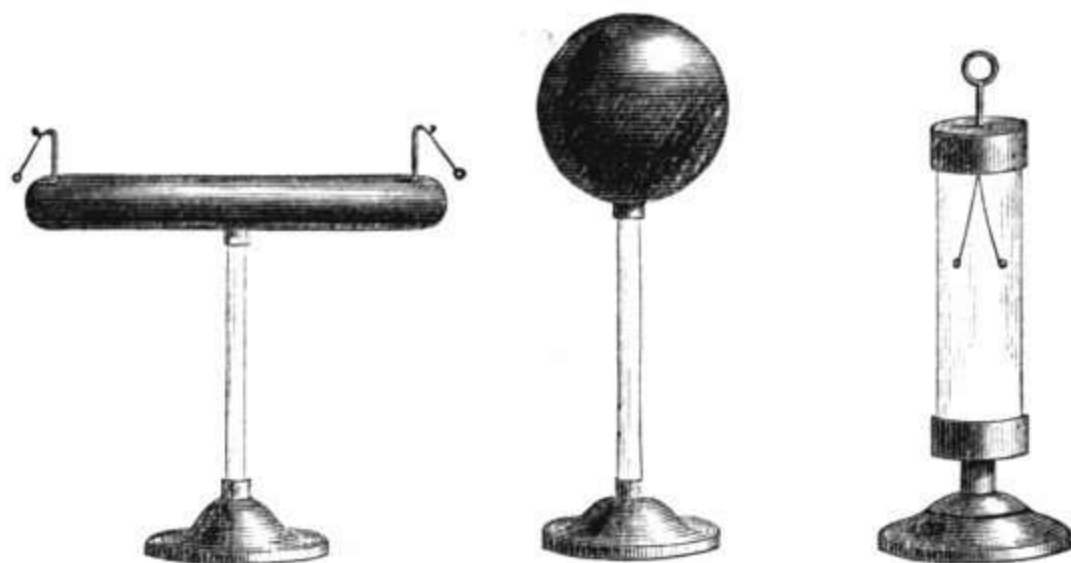

5221.

5222.

5224.

	PRICE
5221. Induction Cylinders, of brass, finely finished, seven inches long, on neat insulating stand.....	\$5 00
5222. Induction Globe, of silvered brass, four inches in diameter, on strong insulating stand.....	8 00
5223. Pith Ball Electroscope, plain .....	75
5224. Plain gold Leaf Electrometer.....	3 75

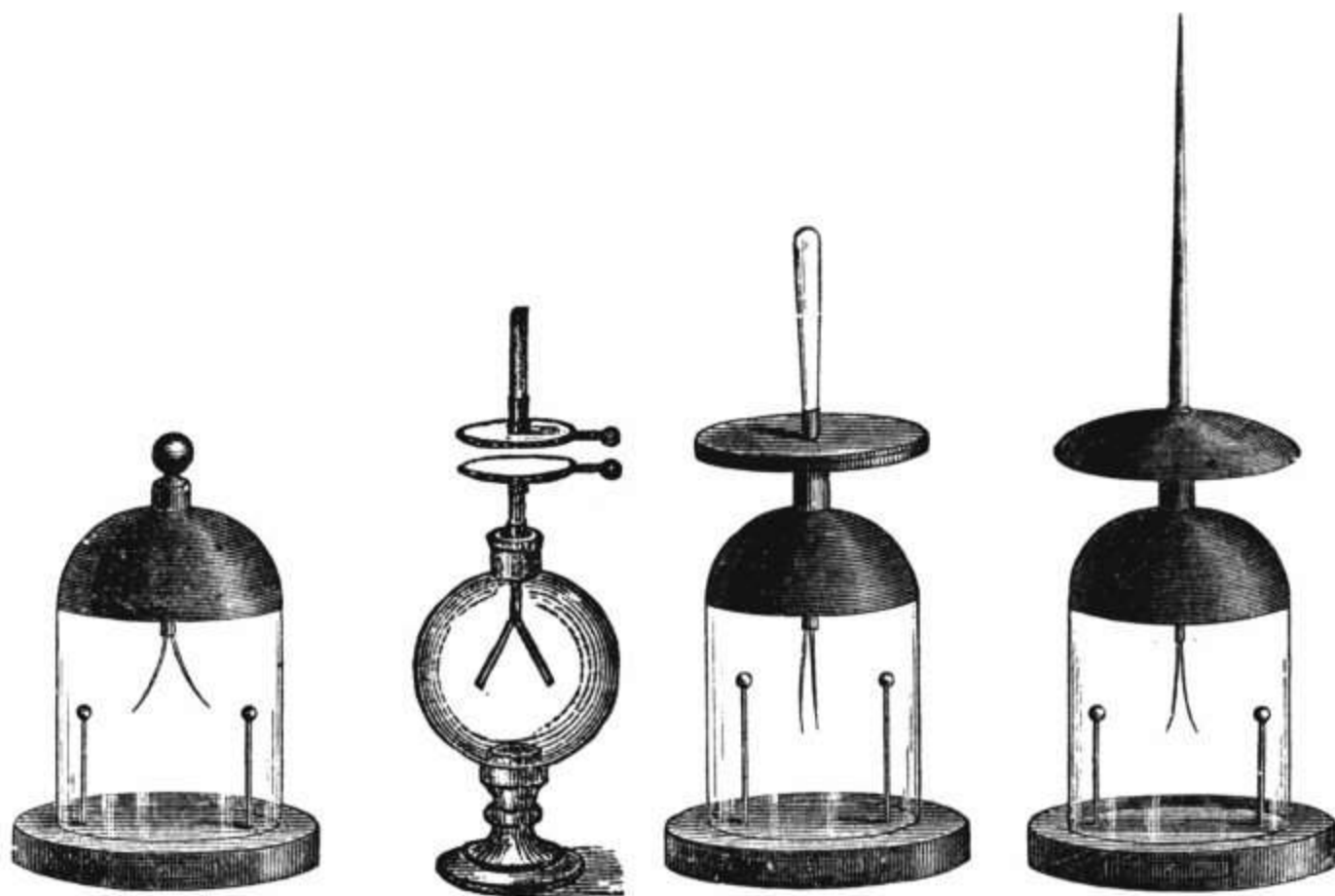

5225.

5226½.

5226.

5227.

5225. Bennett's Electroscope, or Gold Leaf Electrometer, with ball. Glass bell, nine inches high by seven and a half inches in diameter, mounted on wooden base, with drawer for drying material. This and the following electroscopes are finely finished in every part, and are of exceeding delicacy. Large.....	10 00
5226. Bennett's Electroscope, same as No. 5225, but with Volta's condenser instead of ball.....	16 00
5226½. Bennett's Electroscope, but without condenser or balls, with foot, all glass. A very good form, as the interior can easily be kept dry...	10 50
5227. Saussure's Electroscope.....	16 00

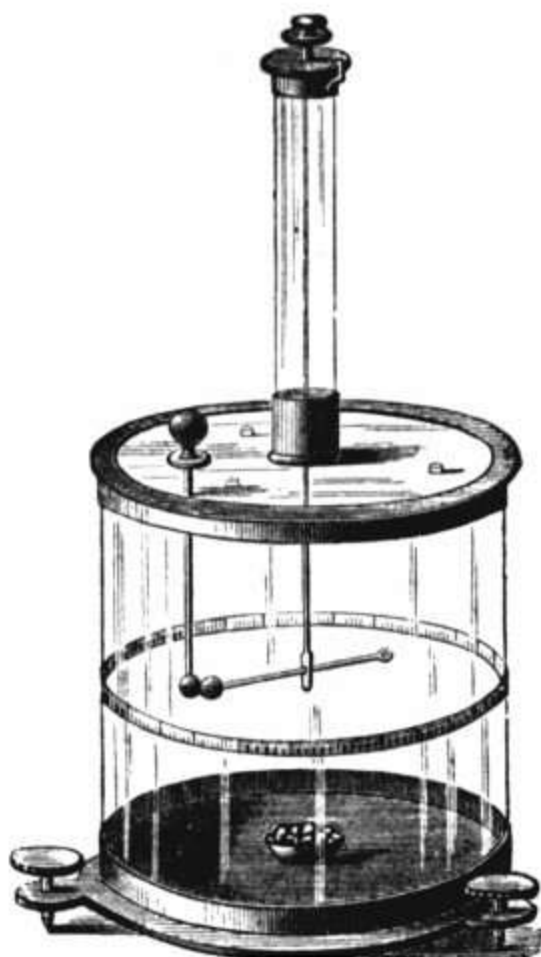

5228.

	PRICE
5228. <b>Coulomb's Electrometer.</b> Glass case, eight inches in diameter, and ten inches high, on neat stand of mahogany.....	\$25 00

## SECTION II.

## INSTRUMENTS FOR OBTAINING ELECTRICITY OF TENSION BY FRICTION.

5240. <b>Electrophorus</b> , of sealing wax, with base and plate, ten inches in diameter.....	6 00
5241. <b>Electrophorus</b> , of sealing wax, with brass base and plate, fifteen inches in diameter.....	10 00
5242. <b>Electrophorus</b> , of vulcanite, ten inches in diameter, with brass base and plate.....	8 00
5243. <b>Electrophorus</b> , of vulcanite, fifteen inches in diameter, with brass base and plate.....	11 00

## QUEEN'S NEW TOEPLER-HOLTZ ELECTRICAL MACHINE.

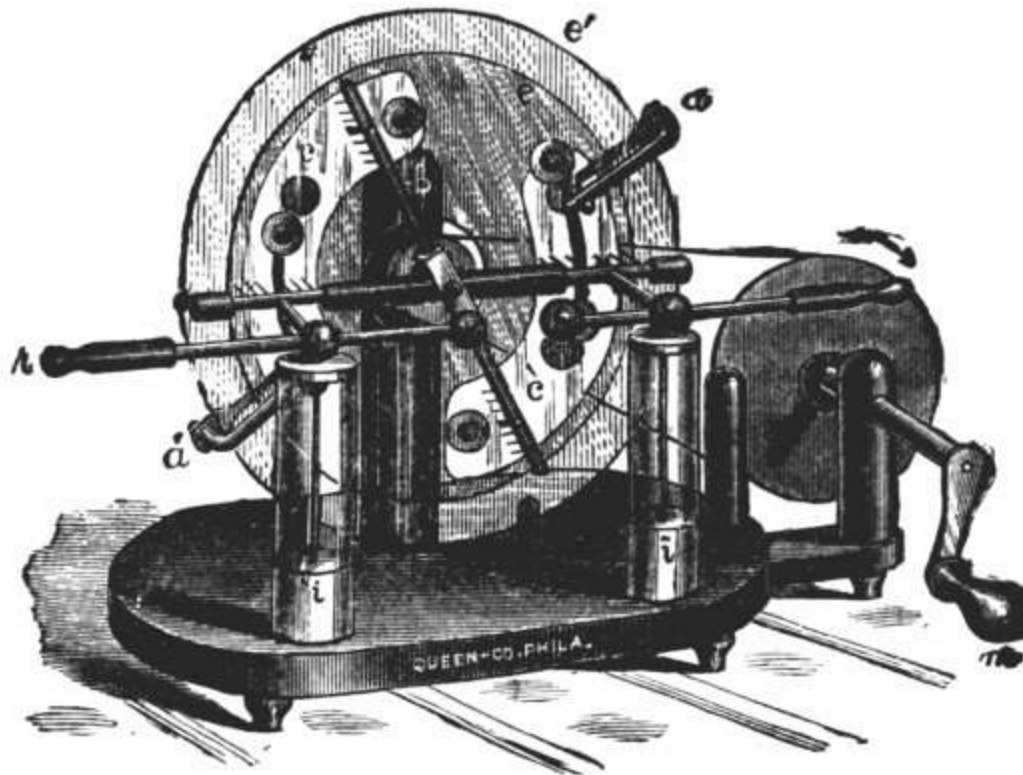

No. 1 to 1g.

- |  |         |
|--|---------|
| No. 1. Queen's New Toepler-Holtz Electrical Machine; gives long and brilliant discharges; self-charging; will work under all atmospheric conditions. Diameter of revolving plate, 26 centimeters = 10½ inches, giving 5-inch spark. Mounted on finely polished base..... | \$25 00 |
| No. 1a. New Toepler-Holtz Electrical Machine; similar to No. 1, but with revolving plate of 31 centimeters = 12½ inches.....   | 30 00   |
| No. 1b. New Toepler-Holtz Electrical Machine; with revolving plate of 36 centimeters = 14½ inches.....   | 40 00   |
| No. 1c. New Toepler-Holtz Electrical Machine; with revolving plate of 41 centimeters = 16½ inches.....   | 50 00   |
| No. 1d. New Toepler-Holtz Electrical Machine; with revolving plate of 47 centimeters = 19 inches.....  | 70 00   |
| No. 1e. New Toepler-Holtz Electrical Machine; with revolving plate of 52 centimeters = 21 inches.....  | 85 00   |
| No. 1f. New Toepler-Holtz Electrical Machine; with revolving plate of 57 centimeters = 23 inches.....  | 120 00  |
| No. 1g. New Toepler-Holtz Electrical Machine; with revolving plate of 62 centimeters = 25 inches.....  | 175 00  |
| Special duty-free prices on the machines in this list on application.  |         |

## TOEPLER-HOLTZ ELECTRICAL MACHINES.

SELF-CHARGING.

*Will work under all atmospheric conditions. Best make, most improved form, and most complete. No. 2 Machines.*

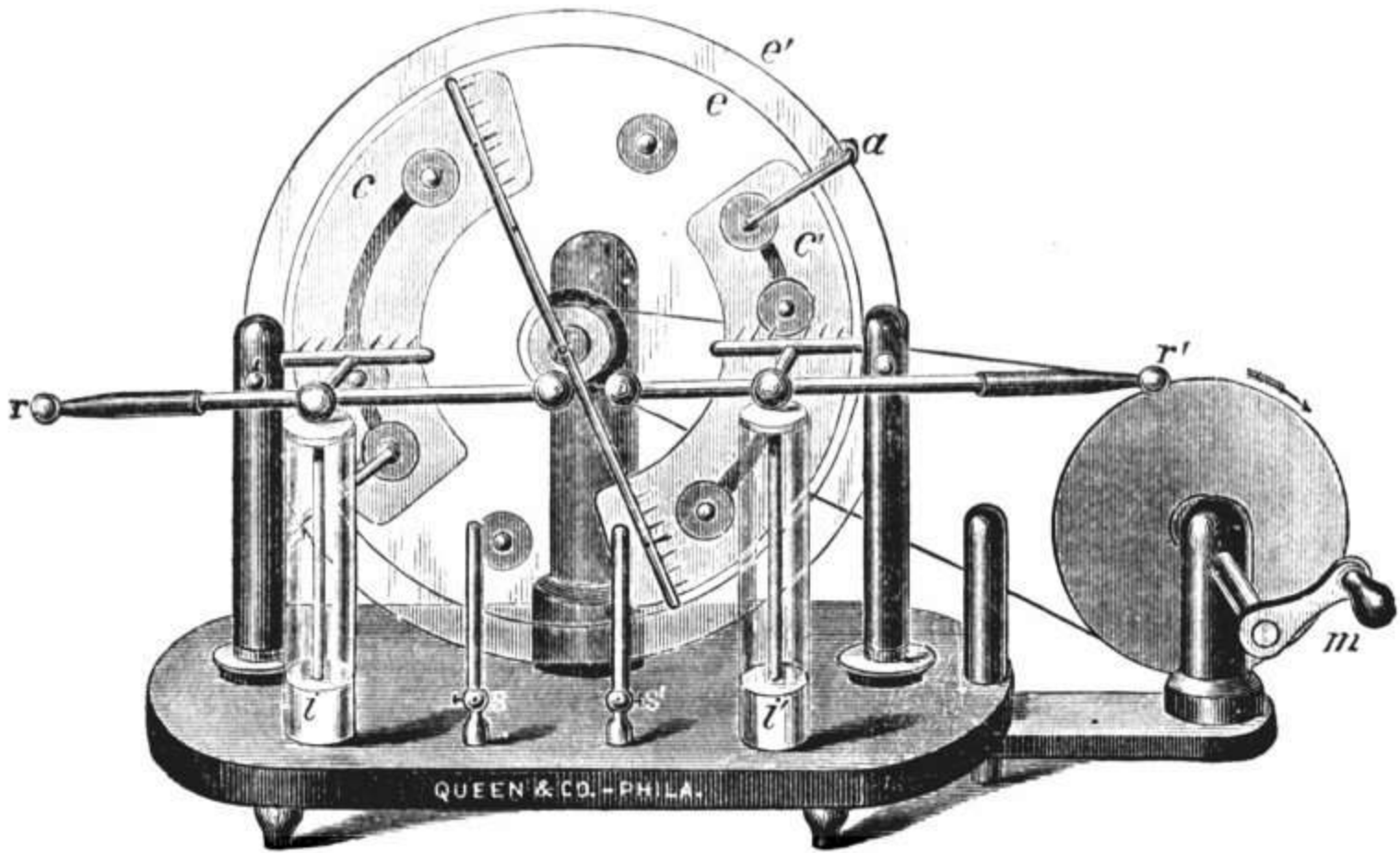

No. 2.

**No. 2a. New Toepler-Holtz Electrical Machine**; self-charging; fitted with rubber supports, with neat and new arrangement for adjusting the combs, etc., to the plates; also with adjustment for the plates; diameter of revolving plate, 26 centimeters = 10½ inches; elegantly mounted on polished mahogany base, with Geissler tube attachment, conical bearings for rubber supports, etc..... \$35 00

This machine is constructed with the utmost care, of the very best material, and is the finest and most complete machine made.

No. 2b. New Toepler-Holtz Electrical Machine; similar to 2a, but with revolving plate of 31 centimeters = 12½ inches.....	50 00
No. 2c. New Toepler-Holtz Electrical Machine; with revolving plate of 36 centimeters = 14½ inches.....	60 00
No. 2d. New Toepler-Holtz Electrical Machine; with revolving plate of 41 centimeters = 16½ inches.....	75 00
No. 2e. New Toepler-Holtz Electrical Machine; with revolving plate of 47 centimeters = 19 inches.....	90 00
No. 2f. New Toepler-Holtz Electrical Machine; with revolving plate of 52 centimeters = 21 inches.....	115 00
No. 2g. New Toepler-Holtz Electrical Machine; with revolving plate of 57 centimeters = 23 inches.....	155 00
No. 2h. New Toepler-Holtz Electrical Machine; with revolving plate of 62 centimeters = 25 inches.....	200 00
No. 2i. New Toepler-Holtz Electrical Machine; with revolving plate of 75 centimeters = 30 inches.....	250 00
No. 2j. New Toepler-Holtz Electrical Machine; with revolving plate of 90 centimeters = 36 inches.....	275 00

## TOEPLER-HOLTZ ELECTRICAL MACHINES.

*With double revolving Plates, self-charging, complete on Mahogany base.  
Similar to No. 2, but with two revolving and two stationary plates.*

No. 3a.	New Toepler-Holtz Electrical Machine; self-charging; double revolving plates, 26 centimeters = 10½ inches in diameter, mahogany base, beautifully finished.....	\$65 00
No. 3b.	New Toepler-Holtz Electrical Machine; similar to 3a, but with revolving plates 31 centimeters in diameter = 12½ inches.....	80 00
No. 3c.	New Toepler-Holtz Electrical Machine; with revolving plates of 36 centimeters = 14½ inches.....	100 00
No. 3d.	New Toepler-Holtz Electrical Machine; with revolving plates of 41 centimeters = 16½ inches.....	120 00
No. 3e.	New Toepler-Holtz Electrical Machine; with revolving plates of 47 centimeters = 19 inches.....	160 00
No. 3f.	New Toepler-Holtz Electrical Machine; with revolving plates of 52 centimeters = 21 inches.....	170 00
No. 3g.	New Toepler-Holtz Electrical Machine; with revolving plates of 57 centimeters = 23 inches.....	230 00
No. 3h.	New Toepler-Holtz Electrical Machine; with revolving plates of 62 centimeters = 25 inches.....	260 00
No. 3i.	New Toepler-Holtz Electrical Machine; with revolving plates of 75 centimeters = 30 inches.....	300 00
No. 3j.	New Toepler-Holtz Electrical Machine; with revolving plates of 90 centimeters = 36 inches.....	400 00

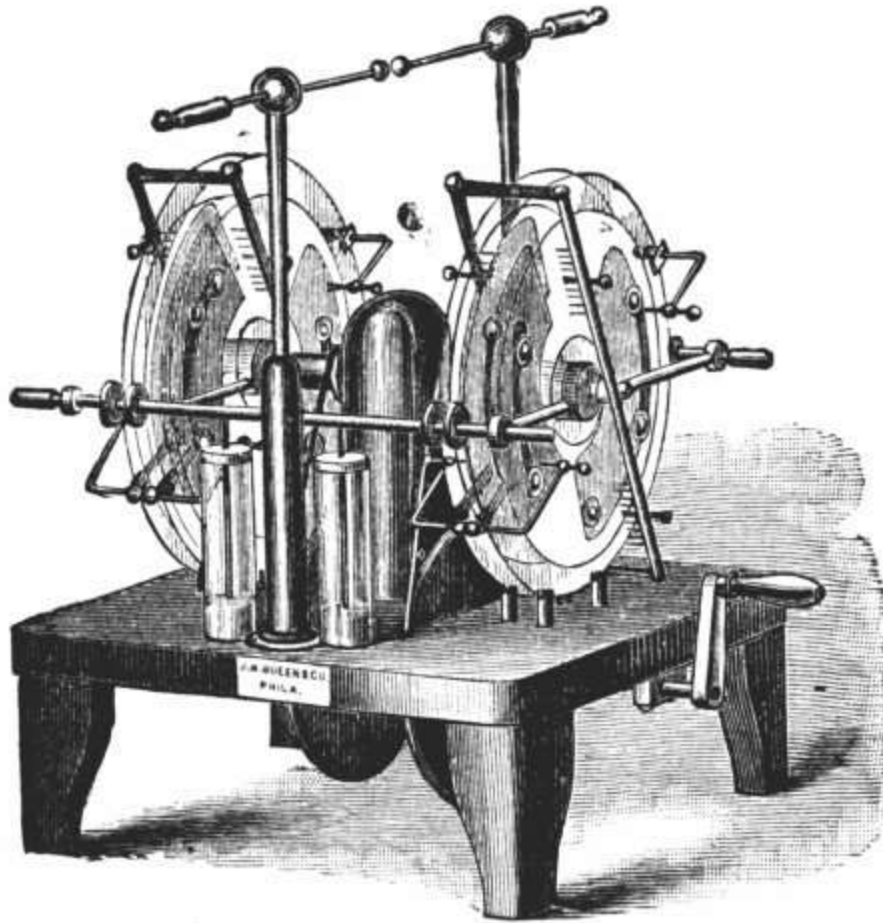

## TOEPLER-HOLTZ ELECTRICAL MACHINES.

*With four revolving plates.*

No. 4a.	New Toepler-Holtz Electrical Machine; with four revolving plates, 36 centimeters = 14½ inches in diameter, mounted on mahogany base, with central mahogany pillar, all elegantly polished. This instrument is of superior workmanship, and the results which can be obtained with it are very fine.....	125 00
---------	---	--------

No. 4b.	New Toepler-Holtz Electrical Machine; similar to 4a, but with revolving plates of 41 centimeters = 16½ inches.....	\$160 00
No. 4c.	New Toepler-Holtz Electrical Machine; with revolving plates of 47 centimeters = 19 inches.....	185 00
No. 4d.	New Toepler-Holtz Electrical Machine; with revolving plates of 52 centimeters = 21 inches.....	225 00
No. 4e.	New Toepler-Holtz Electrical Machine; with revolving plates of 57 centimeters = 23 inches.....	275 00
No. 4f.	New Toepler-Holtz Electrical Machine; with revolving plates of 62 centimeters = 25 inches.....	350 00
No. 4g.	New Toepler-Holtz Electrical Machine; with revolving plates of 75 centimeters = 30 inches.....	400 00
No. 4h.	New Toepler-Holtz Electrical Machine; with revolving plates of 90 centimeters = 36 inches.....	475 00



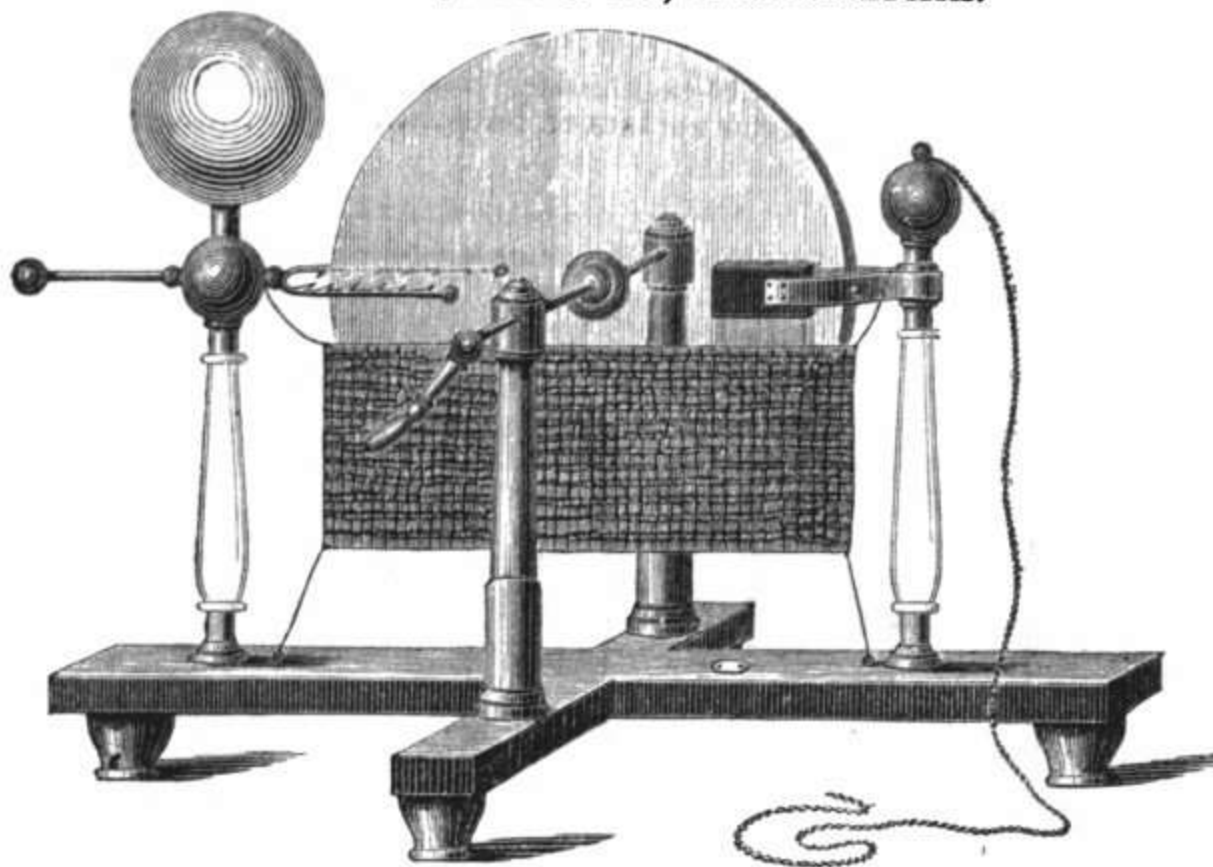

5244-48.

	PRICE.
5244. <b>Friction Machine.</b> Plate, of <i>glass</i> , twelve inches in diameter, with solid walnut base. Prime Conductor of tin, neatly japanned, silk apron, box of amalgam, and three feet of brass chain.....	\$20 00
5245. <b>Friction Machine.</b> Glass plate, sixteen inches in diameter, solid walnut base, finely polished, felt rubbers of best quality, insulated positive and negative conductors, of brass; Rogers' condenser, silk apron, box of amalgam, and four feet of brass chain.....	22 00
5246. <b>Friction Machine.</b> Glass plate, twenty inches in diameter, with solid polished walnut base, felt rubbers of best quality, insulated positive and negative conductors, of brass; Rogers' condenser, silk apron, box of amalgam, and five feet of brass chain.....	30 00
5247. <b>Friction Machine.</b> Glass plate, twenty-four inches in diameter, with solid polished walnut base, felt rubbers of best quality, insulated positive and negative conductors, of brass; Rogers' condenser, silk apron, box of amalgam, and six feet of brass chain.....	42 00
5248. <b>Friction Machine.</b> Glass plate, thirty inches in diameter, with solid polished walnut base, felt rubbers of best quality, insulated positive and negative conductors, of brass; Rogers' condenser, silk apron, box of amalgam, and eight feet of brass chain.....	70 00

SECTION III.—ON THE ATTRACTION AND REPULSION OF TENSIONAL ELECTRICITY.



5270 and 5271.

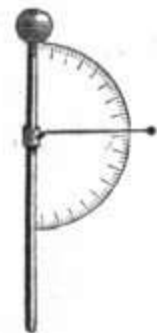

5272.

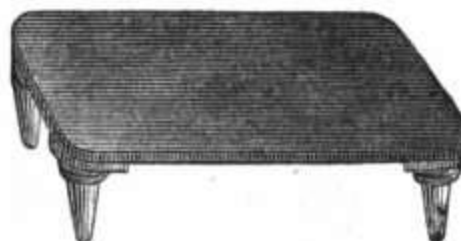

5273 and 5274.

5270. <b>Directing Rod.</b> Of brass, with balls and adjusting slide. Three feet in length, on insulating stand.....	4 50
5271. <b>Directing Rod.</b> Same as No. 5270, but four feet in length.....	6 00
5272. <b>Quadrant Electrometer,</b> and stand .....	2 50

	PRICE.
5273. Insulating Stool. With feet of rubber.....	\$4 50
5274. Insulating Stool. Of mahogany, finely finished, with feet of glass or rubber, fitted into screw sockets of brass.....	6 00



5275.

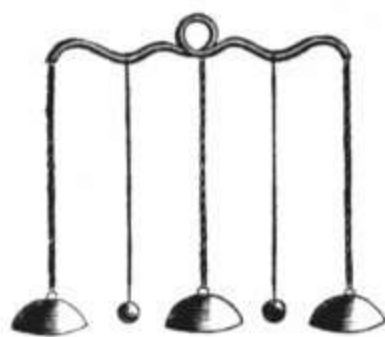

5276.



5277.

5275. Electrical Chime. Two bells.....	1 75
5276. Electrical Chime. Three bells.....	2 00
5277. Electrical Chime. Five bells, centre one four inches in diameter....	9 00
5278. Electrical Vane.....	1 25
5279. Head of Hair.....	1 50
5280. Tissue Figure.....	1 50



5281.

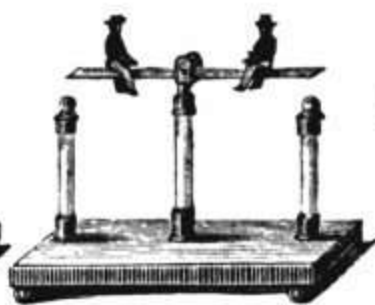

5282.



5283.

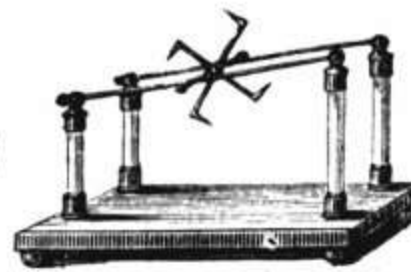

5284.

5281. Electrical Swing.....	4 00
5282. Electrical See-Saw.....	4 50
5283. Electrical Orrery. To place in prime conductor.....	4 50
5284. Electrical Inclined Plane.....	4 00



5285.

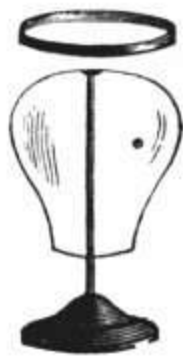

5286.



5286½.



5288.



5289.

5285. Electrical Bucket.....	1 00
5286. Revolving Globe.....	2 75
5286½. Revolving Cylinder.....	3 50
5287. Plate, to screw on sliding rod, for use with capped receiver, to show Volta's Hail Storm.....	75
5287½. Points, to use with capped receiver, showing brush, discharge, etc...	2 00

	PRICE
5288. <b>Volta's Hail Storm</b> .....	\$5 00
5289. <b>Volta's Hail Storm. Arranged for projection</b> .....	5 00

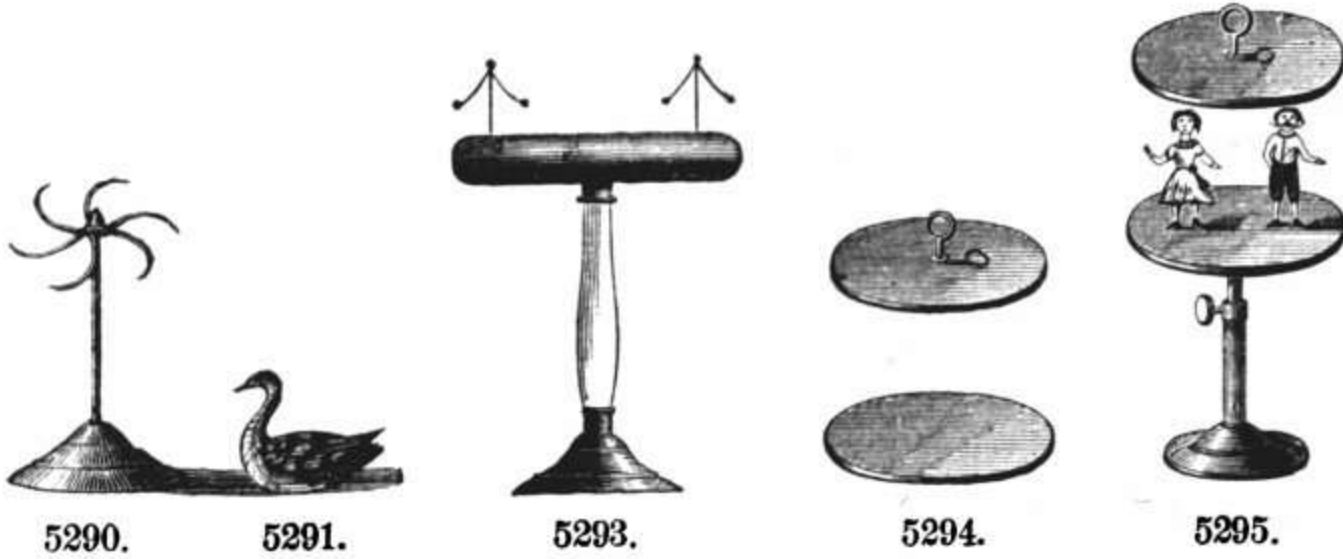

5290. <b>Electrical Flier and Stand</b> .....	1 25
5291. <b>Electrical Swan</b> .....	1 25
5292. <b>Electrical Spider</b> .....	25
5293. <b>Insulated Conductor.</b> Of brass, 5 inches in diameter and 24 inches long.....	20 00
5294. <b>Metallic Plates.</b> For dancing images, for suspension. Of tin, neatly japanned, ten inches in diameter. Not adjustable.....	1 50
5295. <b>Metallic Plates.</b> For dancing images. Similar to No. 5294, but lower one on an adjusting stand.....	4 00
5297. <b>Dancing Images.</b> Of pith, per pair.....	75
5298. <b>Pith Birds.</b> Per dozen.....	1 00

SECTION IV.—CONDENSERS AND THE LEYDEN JAR.

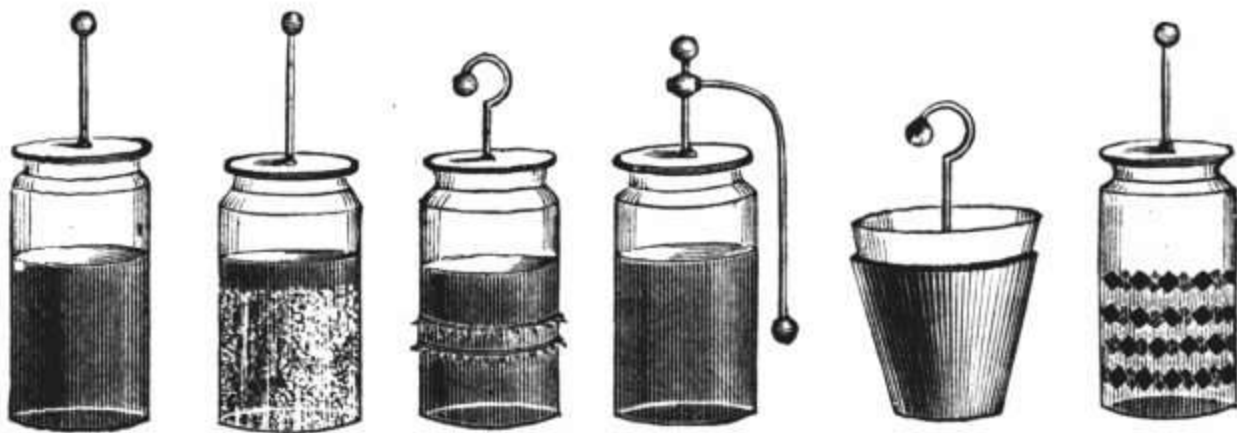

5309-13.      5314.      5315.      5316.      5317.      5318 and 5319.

5309. <b>Leyden Jar.</b> One-half pint.....	1 00
5310. <b>Leyden Jar.</b> One pint.....	1 25
5311. <b>Leyden Jar.</b> One quart.....	1 50
5312. <b>Leyden Jar.</b> One half gallon.....	2 00
5313. <b>Leyden Jar.</b> One gallon.....	2 50
5314. <b>Lightning Jar.</b> Half gallon.....	2 25
5315. <b>Atmospheric Leyden Jar.</b> Half gallon.....	2 50
5316. <b>Electrometer Jar.</b> Half gallon.....	2 50
5317. <b>Leyden Jar.</b> With movable coatings.....	2 00
5318. <b>Diamond Jar.</b> Half gallon.....	3 00
5319. <b>Diamond Jar.</b> Gallon.....	3 75

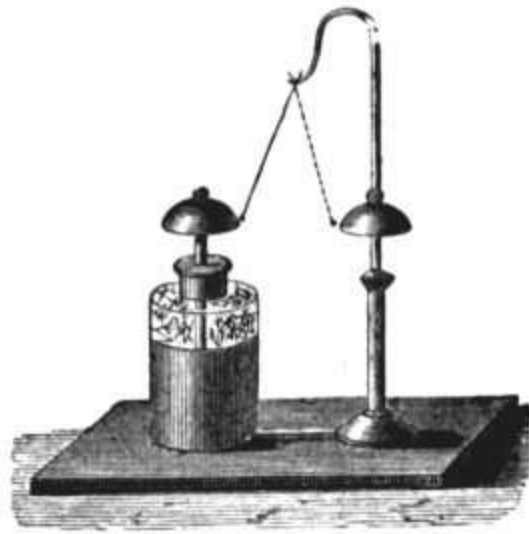

5320.

5320. **Leyden Jar.** With bell and ball for slow discharge..... **PRICE \$4 50**



5321 and 22.

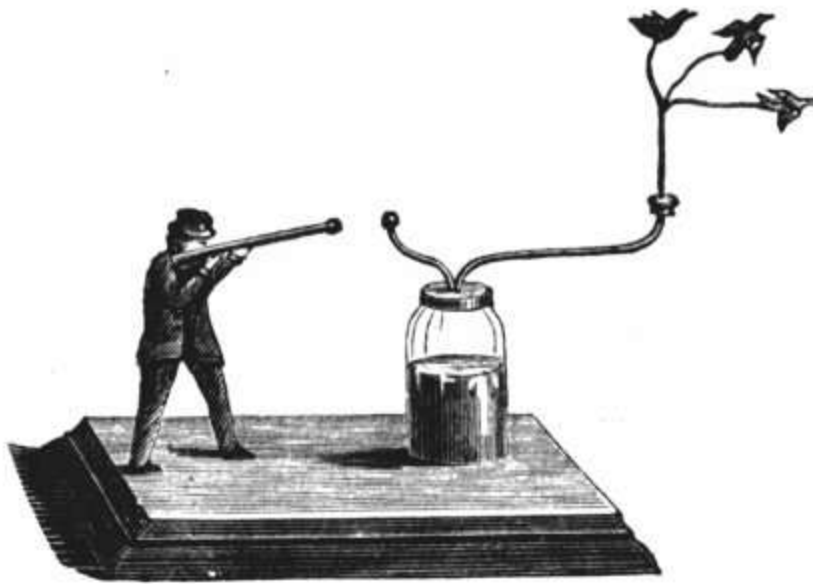

5324.



5325.

5321. <b>Double Jar.</b> Pint and quart.....	3 50
5322. <b>Double Jar.</b> Quart and half gallon.....	4 00
5323. <b>Unit Jar.</b> For measuring the quantity of electricity ...	12 00
5324. <b>Electrical Sportsman.</b> On stand, with Leyden jar, and birds .....	5 00
5325. <b>Electrical Sportsman and electrometer jar</b> with birds.....	3 75
5326. <b>Electrical Sportsman, and birds, without jar.</b> .....	1 25
5327. <b>Miser's Plate.</b> Ten inches by twelve, unmounted.....	1 00
5328. <b>Miser's Plate.</b> Same as No. 5327, but in a neat walnut frame....	2 00

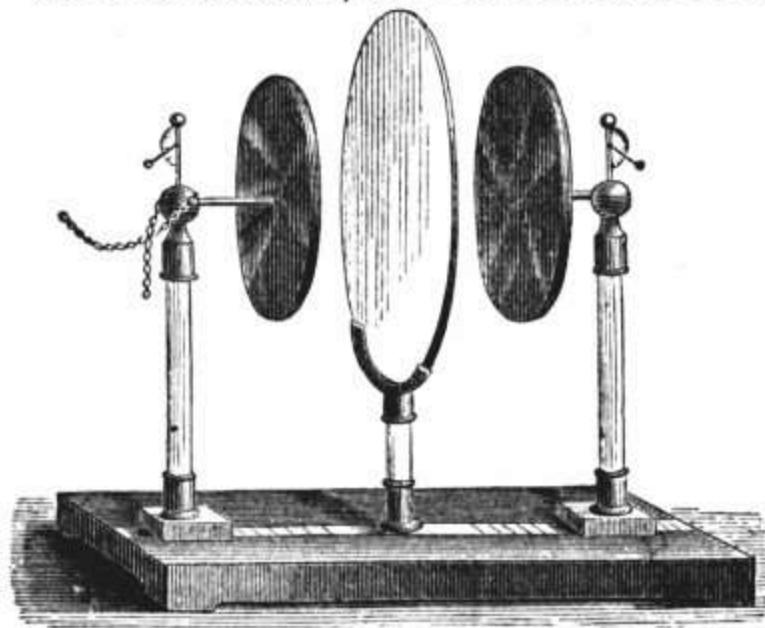

5335.

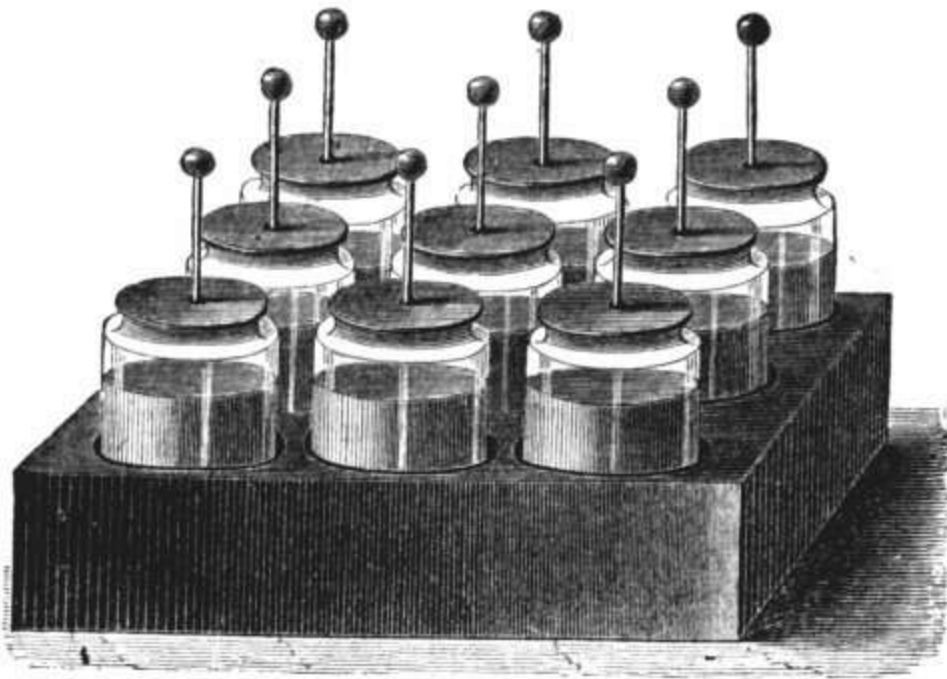

5340.

	PRICE
5335. Condenser of <b>Epinus</b> . Outer plates each six and a half inches in diameter, on neat mahogany stand.....	\$16 00
5335½. Condenser of <b>Epinus</b> , as above, but finer.....	20 00
5336. <b>Electrical Battery</b> . In neat walnut tray, containing four quart jars..	9 00
5337. <b>Electrical Battery</b> . Similar to No. 5336, but with six quart jars.....	13 00
5338. <b>Electrical Battery</b> . In neat walnut tray, containing four half-gallon jars.....	12 00
5339. <b>Electrical Battery</b> . Similar to No. 5338, but with six half-gallon jars.	15 00
5340. <b>Electrical Battery</b> . Same as above, but with nine half-gallon jars...	23 00
5341. <b>Electrical Battery</b> . In neat walnut tray, with handles, containing four one-gallon jars.....	15 00
5342. <b>Electrical Battery</b> . Similar to No. 5341, but with six one-gallon jars.	22 00

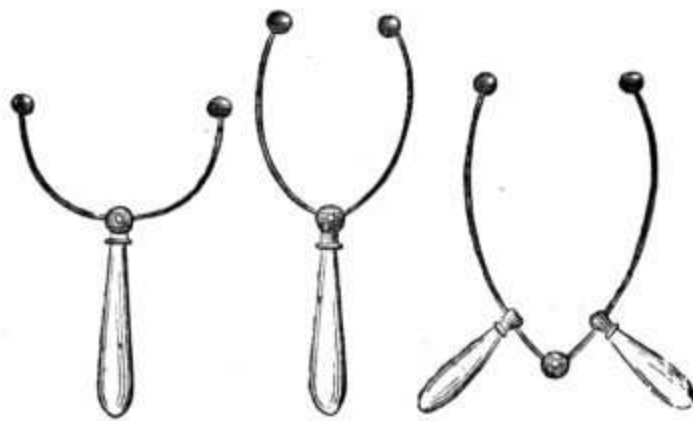

5345.

5346.

5347.

5345. <b>Glass or Rubber Handle Discharger</b> . Not jointed.....	2 25
5346. <b>Glass or Rubber Handle Discharger</b> . Jointed.....	3 50
5347. <b>Discharger</b> . With two handles of glass or rubber.....	4 00

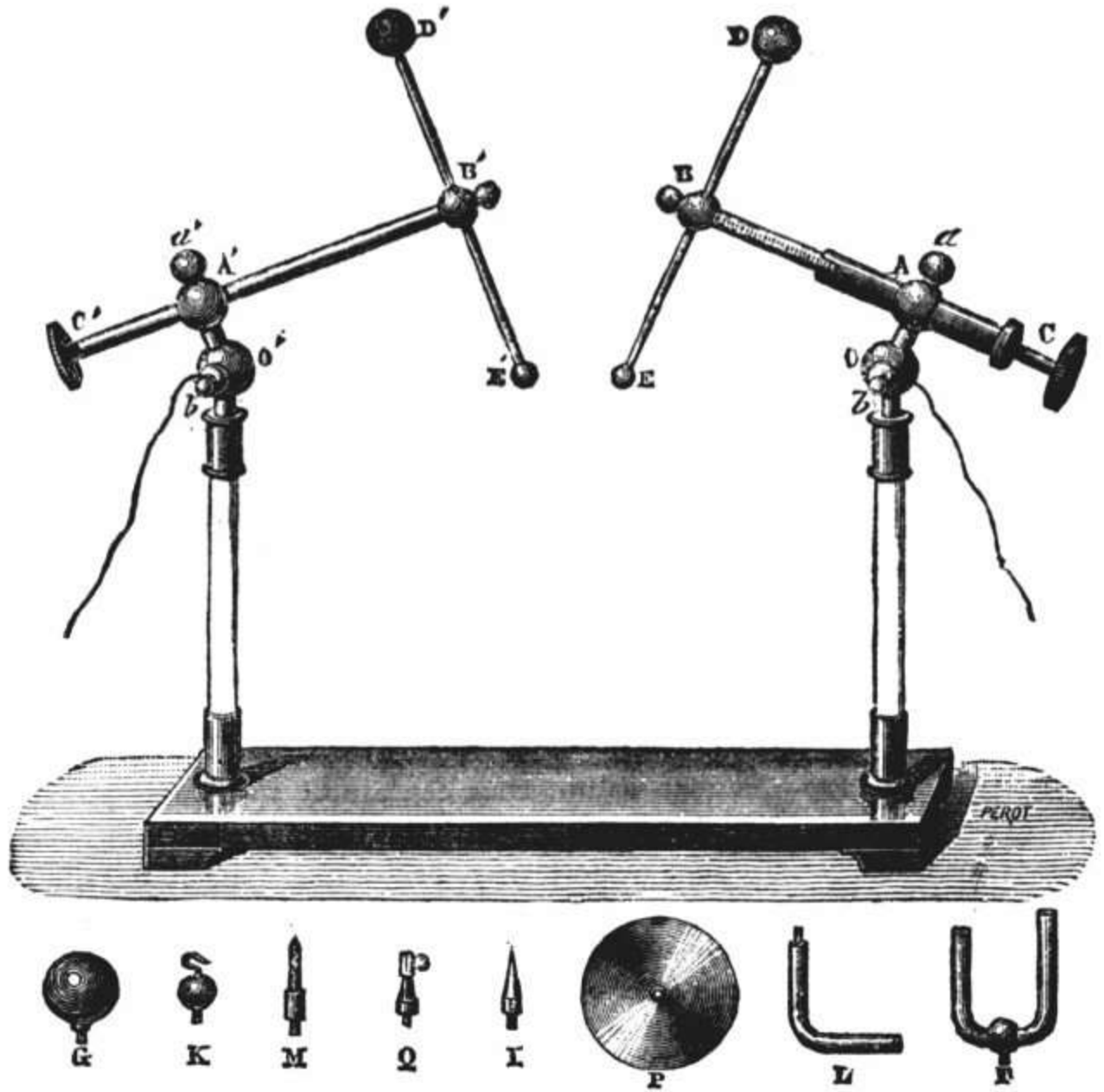

5348.

5348. **Henley's Universal Discharger, or Table for Experiments, with balls, ball with hook, carbon holders, points bent arms, discs, etc.** All these accessories can be placed on a detachable joint..... 15 00

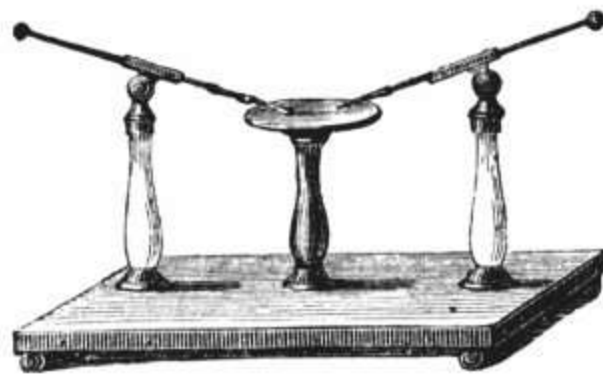

5349.

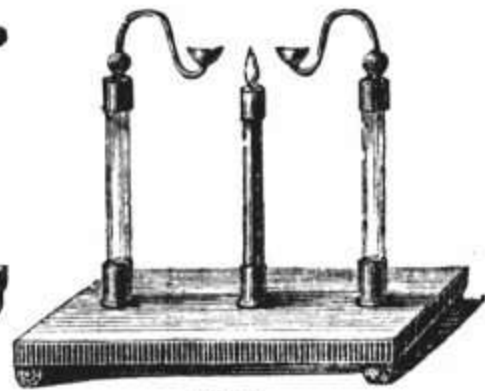

5350.

5349. **Universal Discharger. Insulated arms and adjusting table.....** 12 00  
 5350. **Phosphorus Apparatus.....** 4 50

SECTION V.—ON THE ELECTRICAL DISCHARGE.

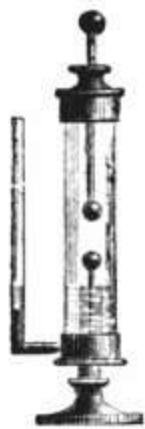

5359.

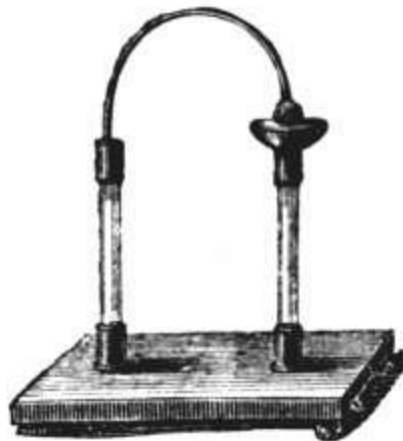

5360.



5361.

	PRICE
5359. Kinnersley's Thermometer .....	\$5 00
5360. Powder Apparatus.....	4 50
5361. Powder Bomb. Of wood, on mahogany base.....	2 00
5362. Gas Pistol, of Japanned Tin.....	75

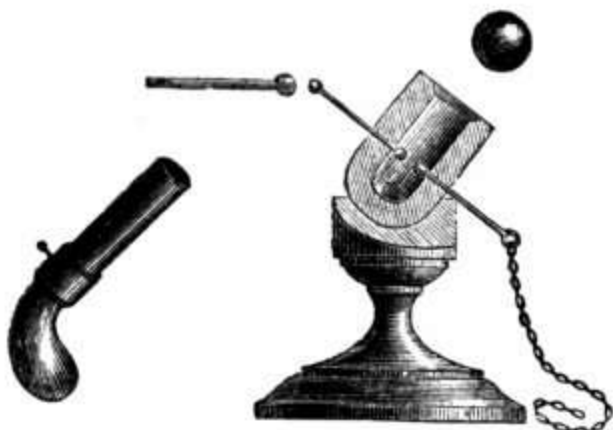

5363.



5364.



5366.



5367.



5368.

5363. Electrical Pistol. Of brass, with wooden handle.....	4 00
5364. Electrical Bomb. Of ivory, on mahogany base.....	3 00
5366. Fire House of Japanned Tin.....	4 50
5367. Ether Cup, with ball at centre and with handle of wood.....	1 00
5368. Brass Ball. On handle, to be used in igniting cotton.....	1 25
5369. Thunder House, so hinged as to blow open when the electric spark is applied.....	8 50
5370. Fulminating Pane. Plate of Glass, twelve inches square, with the middle coated with filings, to show the zigzag course of the electric spark. Not framed.....	1 00
5371. Fulminating Pane. In neat frame, on stand.....	3 00
5372. Luminous Pane. With various devices, such as a star, arch, motto, flowers, etc., etc., in neat frame on stand.....	5 00
5373. Luminous Globe. On polished walnut base.....	7 00
5374. Luminous or Diamond Tube. Straight. One foot long.....	2 50
5375. Luminous Tube. Straight. Two feet long.....	3 00
5376. Luminous Tube. Straight. Three feet long.....	3 50
5377. Luminous Tube. With hook for suspension. Three feet long.....	4 00

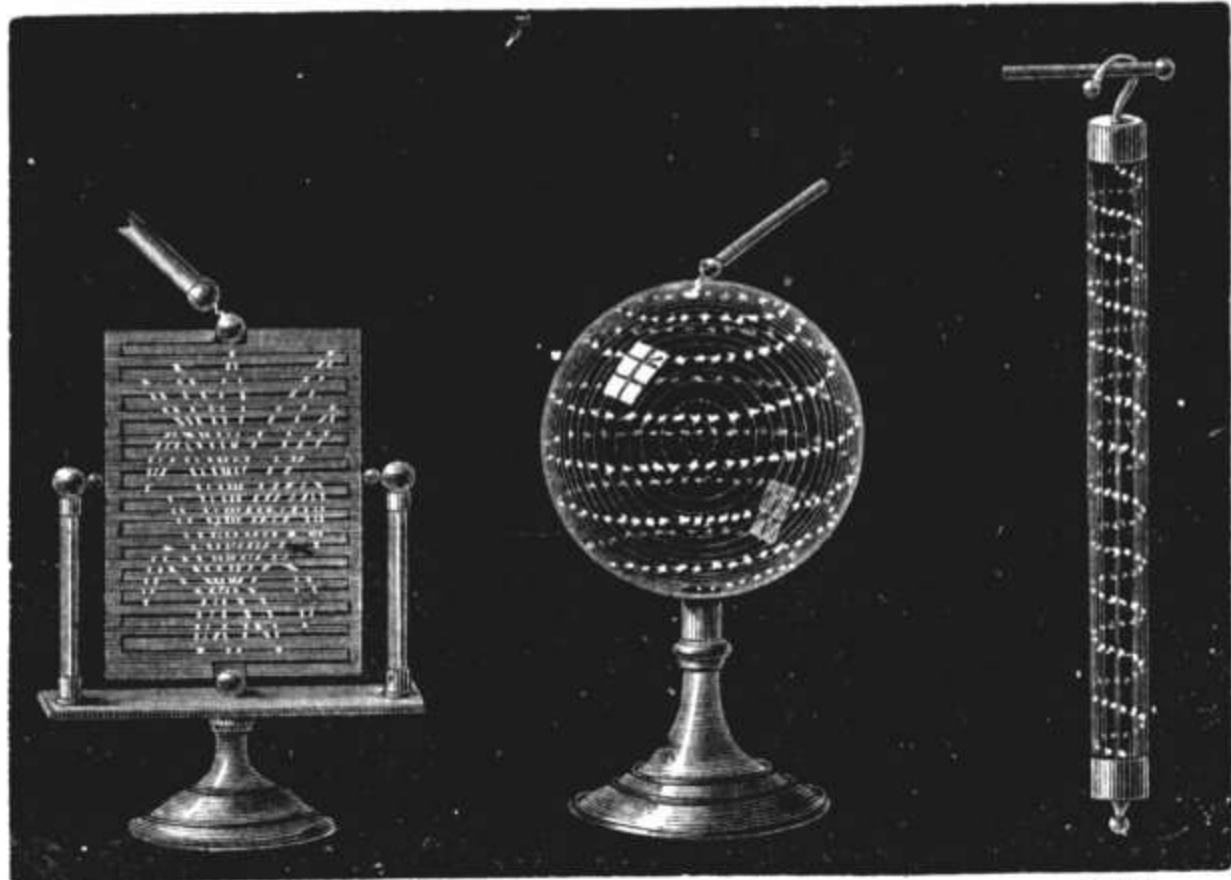

5372.

5373.

5377.

	PRICE
5380. Aurora Tube. Plain glass, three feet long.....	\$7 00
5381. Aurora Tube. Plain glass, four feet long.....	8 00
5382. Aurora Tube. Plain glass, extra size, four feet long.....	10 00
5384. Aurora Tube. Of uranium glass, three feet long.....	10 00

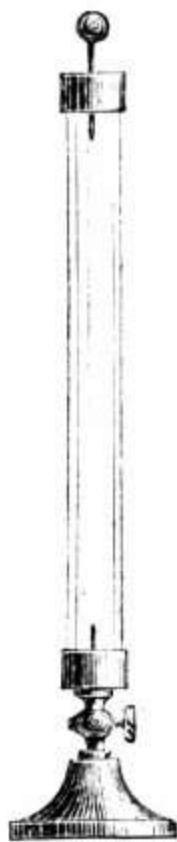

5380-84.



5388.



5389-92.

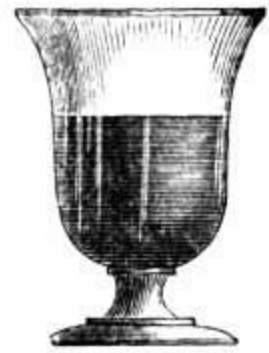

5395-98.

5388. Abbe Nollett's Globe, with receiver.....	6 00
5389. Electrical Egg. Twelve inches high, of plain glass.....	7 50
5390. Electrical Egg. Sixteen inches high, plain glass.....	9 00
5391. Electrical Egg. Of uranium glass, twelve inches high.....	8 00
5392. Electrical Egg. Of uranium glass, sixteen inches high.....	11 00
5395. Gassiot's Cascade. Of plain glass, goblet at top four inches in diameter.....	1 25



	PRICE
5396. Gassiot's Cascade. Of uranium glass, four inches in diameter.....	\$2 00
5397. Gassiot's Cascade. Of uranium glass, five inches in diameter.....	2 50
5398. Gassiot's Cascade. Of uranium glass, five and a half inches in diameter.....	2 75
5399. Illuminating Egg Stand. Of wood, with metal connections.....	2 00
5400. Block of Uranium Glass. For use under the exhausted receiver of an air-pump.....	2 50
5401. Block of Uranium Glass. Similar to No. 5400, but in neat case.....	4 00

SECTION VI.—ON SUNDRY ACCESSORIES TO ELECTRICAL INSTRUMENTS.

5410. Brass Chain. For connections, per yard.....	15
5411. Copper Wire. Insulated with gutta-percha, per yard.....	10
5413. Amalgam. Per bottle .....	25
5420. Tin Foil. For coatings, per pound.....	50
5421. Glass Plate. Twelve inches in diameter, center drilled and edges ground.....	3 50
5422. Glass Plate. Similar to No. 5421, but sixteen inches in diameter..	4 50
5423. Glass Plate. Similar to No. 5421, but twenty inches in diameter....	7 50
5424. Glass Plate. Similar to No. 5421, but twenty-four inches in diameter.....	10 00

PLATES FOR TOEPLER-HOLTZ MACHINES.

All of our machines are designated by the diameter of the revolving plates.

5425. Plates for 26 cm. (= 10 inch) Machine, each.....	2 00
5426. Plates for 31 cm. (= 12½ inch) Machine, each.....	3 50
5427. Plates for 36 cm. (= 14½ inch) Machine, each.....	4 75
5428. Plates for 41 cm. (= 16½ inch) Machine, each.....	5 75
5429. Plates for 47 cm. (= 19 inch) Machine, each.....	7 00
5430. Plates for 52 cm. (= 21 inch) Machine, each.....	7 75

Larger sizes on application. Stationary plates same prices as revolving plates for the same machines.

CONDENSERS FOR TOEPLER-HOLTZ MACHINES.

5435. Condensers for 26 cm. Machine, each .....	65
5436. Condensers for 31 cm. Machine, each.....	90
5437. Condensers for 36 cm. Machine, each.....	1 25
5438. Condensers for 41 cm. Machine, each.....	1 50
5439. Condensers for 47 cm. Machine, each.....	1 75
5440. Condensers for 52 cm. Machine, each.....	2 00

Larger sizes on application.

SECTION VII.—GALVANIC BATTERIES.

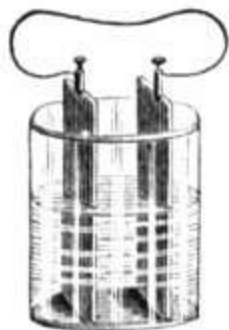

5460.

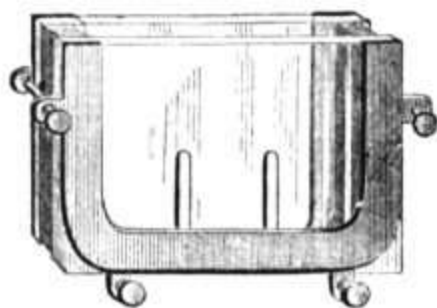

5461.

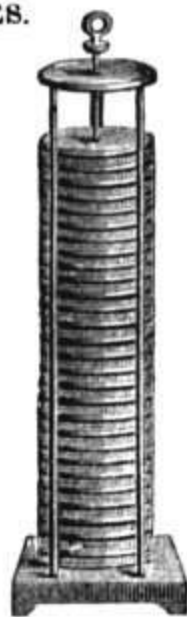

5462.

5460. Simple Galvanic Cell. A plate of copper, another of zinc, with connecting wires and glass cell.....	2 00
5461. Simple Galvanic Cell, for projection.....	4 50
5462. Volta's Column Battery.....	12 00

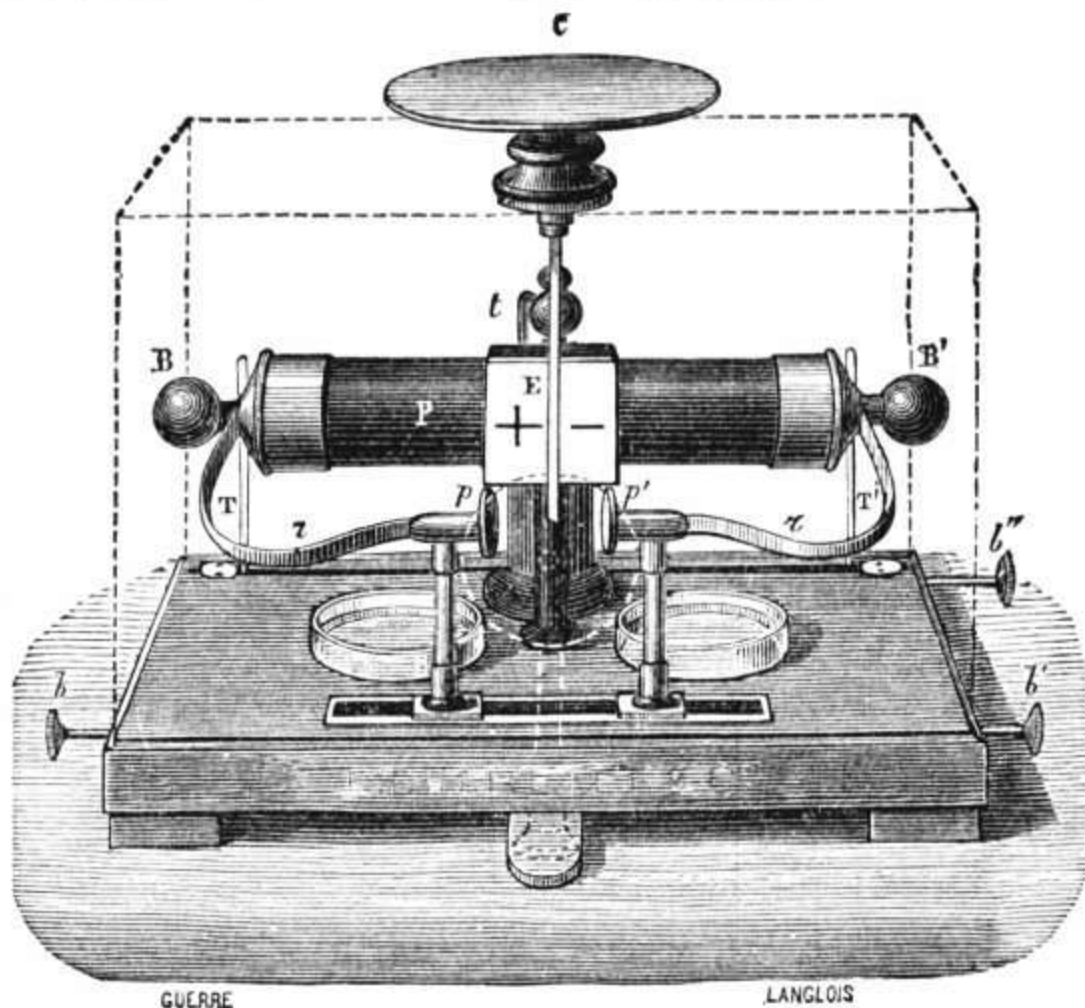

GUERRE

LANGLOIS

5465.

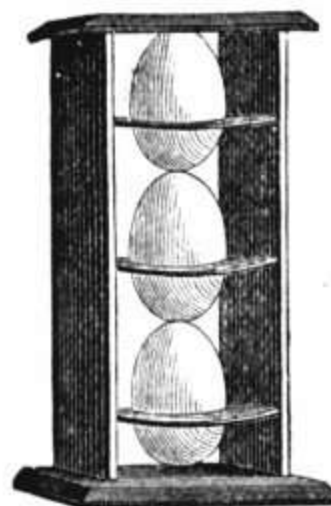

5399.



5400.

5463. Zamboni's Pile. Able to move a needle.....	17 50
5465. Bohnenberger's Electroscope, with dry pile; horizontal model, with insulated movable plates pp', between which is the gold leaf. The plates pp' can be moved by the rods bb' from the outside of the case. The middle of the pile can be connected to the earth. With arrangement to bring the gold leaf to the vertical, or to zero, and opening to observe the gold leaf.....	48 00
5466. Apparatus for Continuous Rotation. Pair of Zamboni's Piles, connected at base and terminated at top by brass balls. A very light needle, terminated by strips of foil, is balanced upon a needle-point so as to rotate. The alternate attractions and repulsions of the two opposite poles keep the needle in rotation for a long time. The whole is covered with a glass shade.....	40 00

QUEEN'S NEW PLUNGE BATTERY.

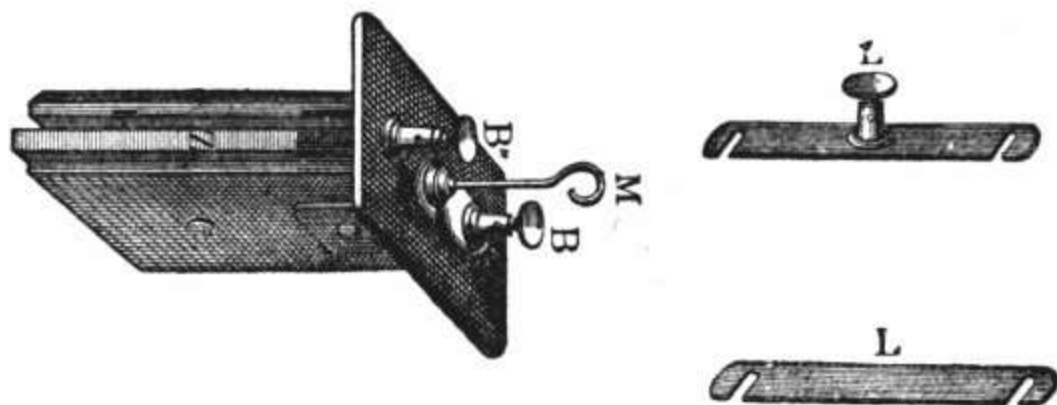
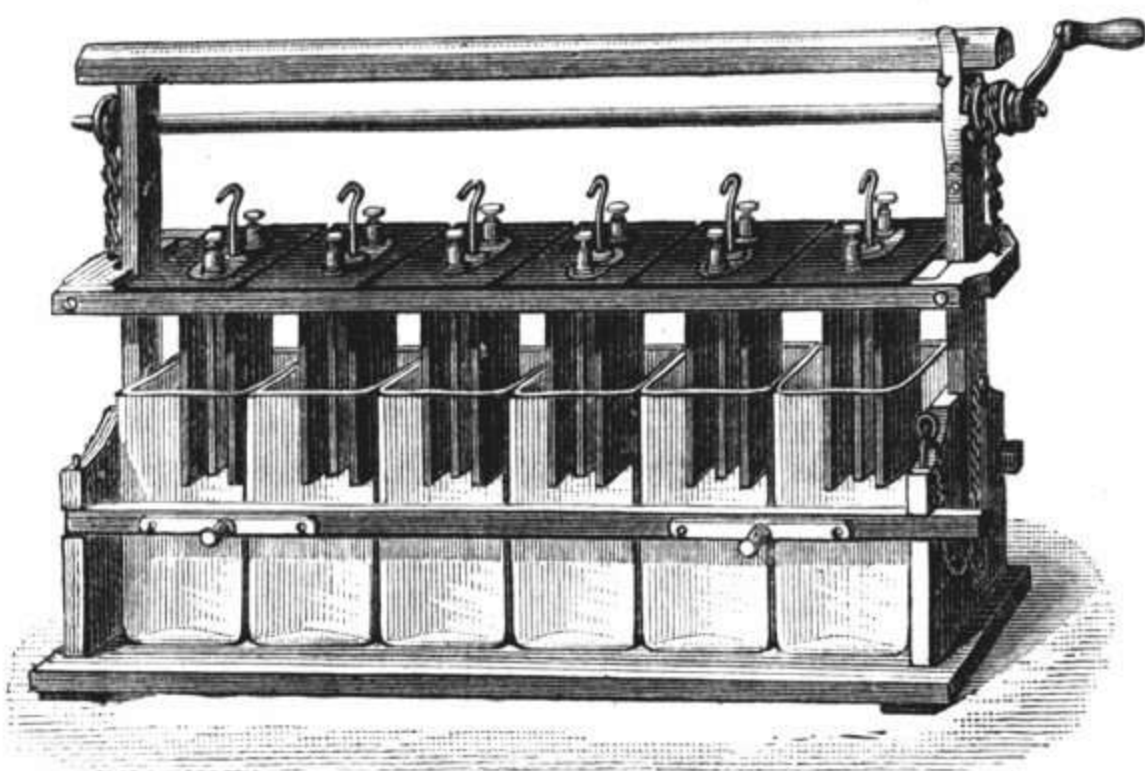

Nos. 1 AND 2.

Queen's New Plunge Battery, on account of its compactness, power, ease of manipulation, simple but perfect arrangement for connecting up for either the quantity or intensity current, has become a general favorite in the lecture-room. The large six-cell battery is fitted with a wheel and ratchet, and is not as represented in the cut. We use this battery daily, to show Crookes' Tubes, Geissler Tubes, etc., etc. It is often allowed to remain weeks, without needing any attention, and is always ready, and is invaluable to the teacher. Great care should be used to see that the battery is taken out of the solution immediately after use. The connections of this battery are detachable, so any number of cells, from one to six, can be used, and can be arranged for either quantity or intensity.

- |  |       |
|--|-------|
| 5500. New Dipping Battery, No. 1, with movable elements, arranged for quantity or intensity; six cells, in wood frame, carbons $3\frac{1}{2} \times 1\frac{1}{2}$ in....                         | 18 00 |
| 5501. New Dipping Battery, No. 2 similar to above cut, with six cells; carbon plates, $5\frac{1}{2} \times 2\frac{1}{2}$ in., with wheel and ratchet, for lifting out of the acid. Complete..... | 35 00 |

PATENT AUTOMATIC BATTERIES.

These are furnished with an arrangement by which the carbon and zincs are automatically raised from the fluid when not in use. Well adapted for demonstration purposes in the class-room. Connections are permanent, hence the battery must be used as a whole, connected for intensity only, amount of current regulated by treadle.

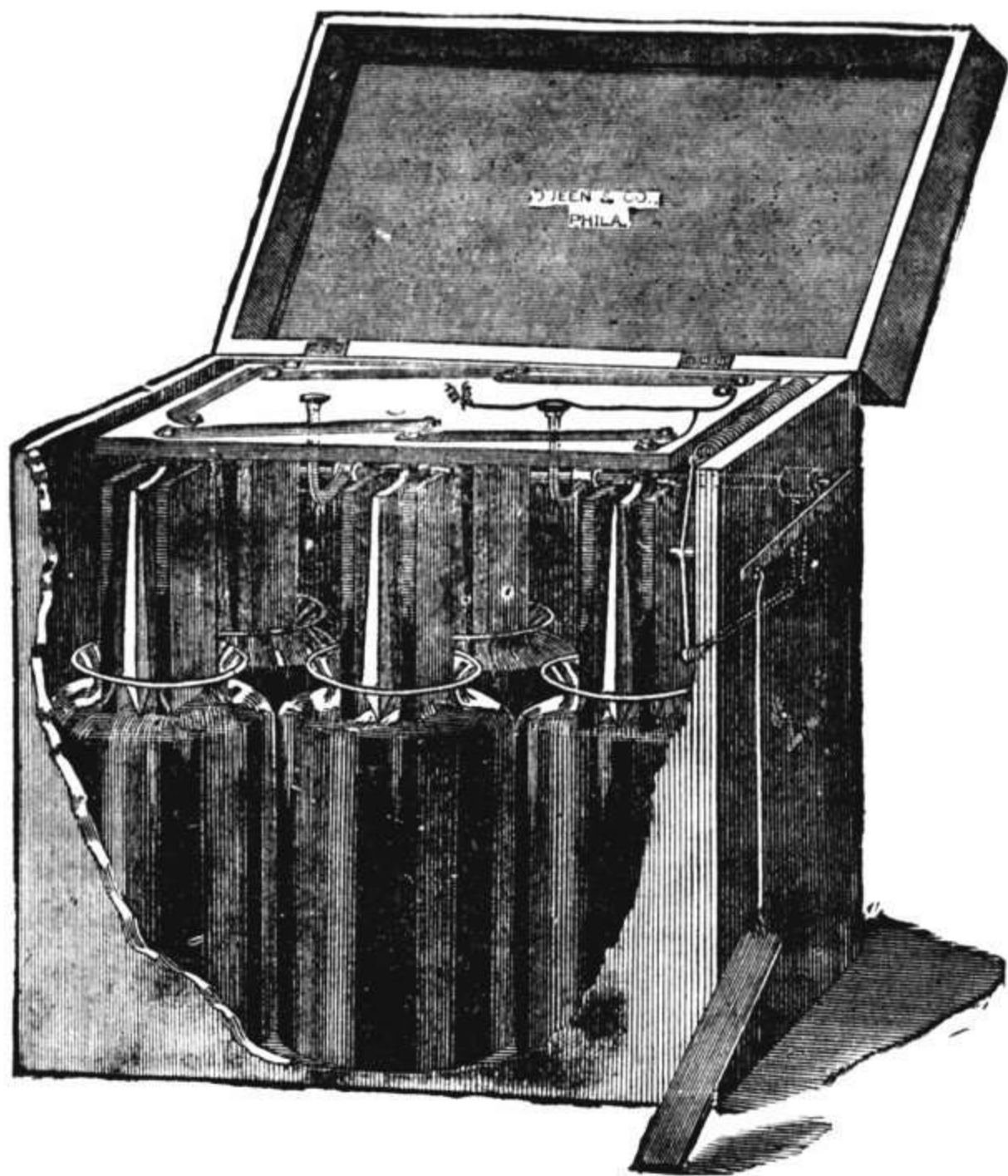

5505i

5505. Patent Automatic Battery, six one-gallon cells, imitation walnut case (carbons $2\frac{1}{2} \times 4\frac{1}{2}$ ).....	15 00
Same as above, in ebonized case.....	20 00
Packing for shipment, on either above.....	1 00
Extra zincs (rolled), each.....	20
Extra carbons, each.....	15

SECTION VIII.—THE GALVANOMETER AND ELECTRICAL MEASUREMENT.

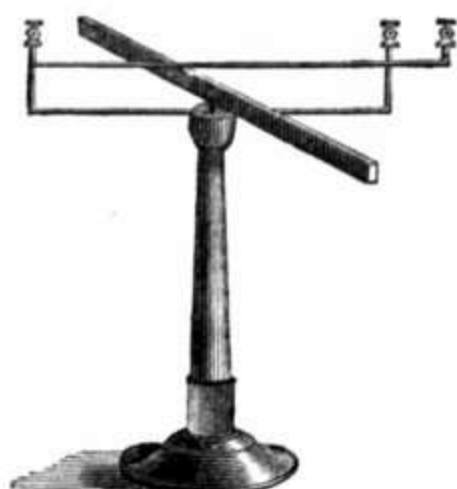

5535 and 5536.



5538.



5539 and 5540.

- |   |       |
|---|-------|
| 5535. Apparatus to Illustrate Oersted's Law. Magnet eight inches long.  | 4 00  |
| 5536. Apparatus to Illustrate Oersted's law. Magnet fifteen inches long   | 7 00  |
| 5537. Galvanometer. Simple form, with single needle suspended upon a needle point at center . . . . .   | 5 00  |
| 5538. Galvanometer, with astatic needle; on rosewood base, with leveling screws, graduated circle, and glass cover . . . . .  | 15 00 |
| 5539. Galvanometer. Similar to No. 5339, but with posts to suspend the needle by a filament of unspun silk, an adjustment for placing the zero of the scale in the axis of the coil, and leveling screws. . . . . | 20 00 |
| 5540. Galvanometer. Similar to No. 5539, but with helix for use in thermo-electric experiments . . . . .  | 20 00 |

SECTION IX.—OF INSTRUMENTS ILLUSTRATING THE HEATING EFFECTS OF DYNAMICAL ELECTRICITY.

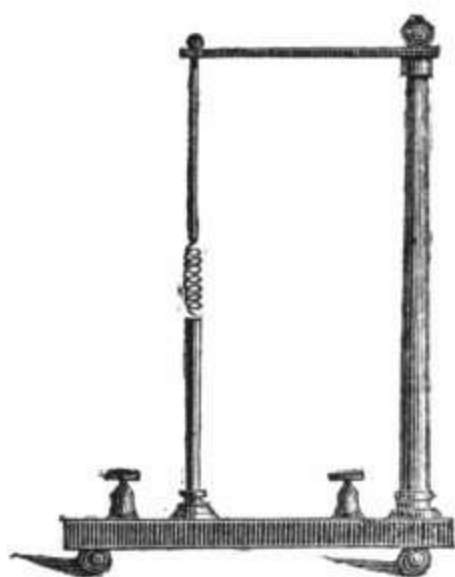

5575.

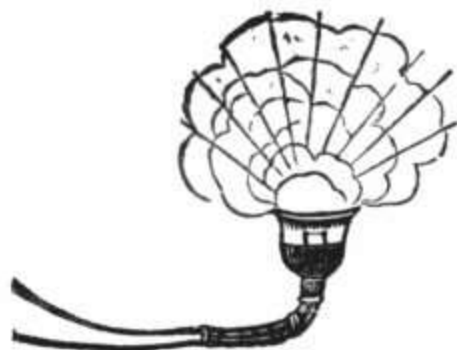

5576.

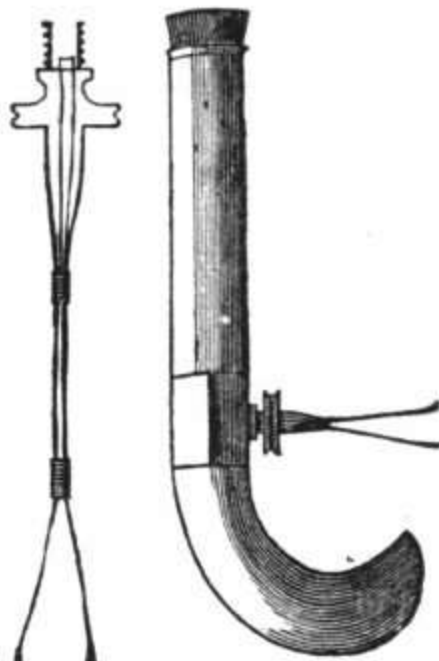

5578.

- |   | PRICE  |
|---|--------|
| 5575. Galvanic Lamp. Of platinum wire in coil, with vertical support of brass, on a neat polished base of mahogany. . . . . | \$5 00 |
| 5576. Powder Cup. Of brass, with platinum wire in coil. . . . .   | 1 00   |
| 5577. Powder Cup. Of brass, with handle of wood, and an extra supply of platinum wire. . . . .                              | 4 00   |
| 5578. Voltaic Pistol. Of brass, strongly made and neatly finished. . . . .  | 5 00   |

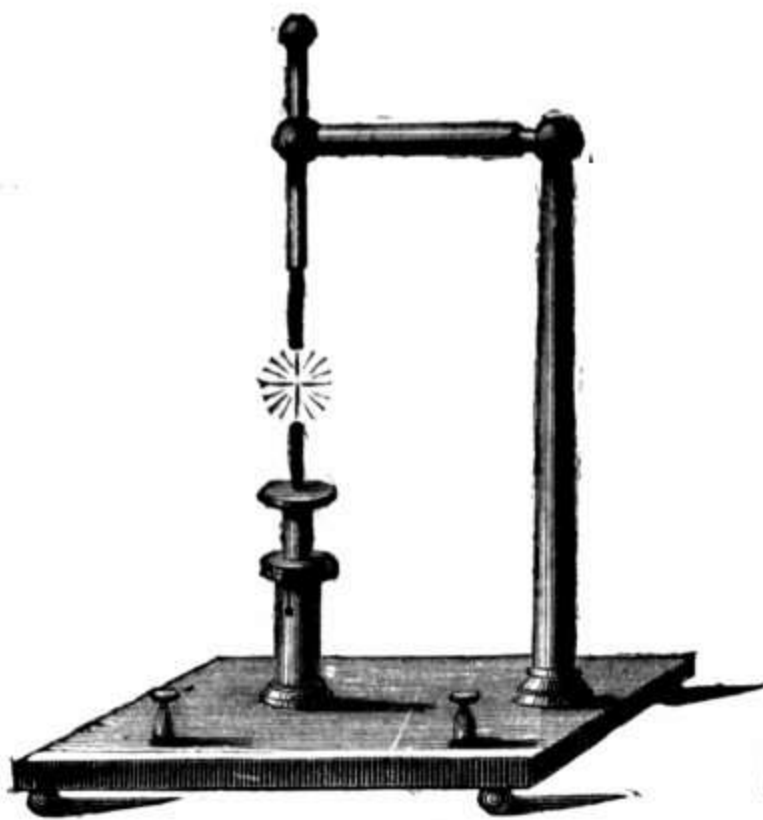

5580.

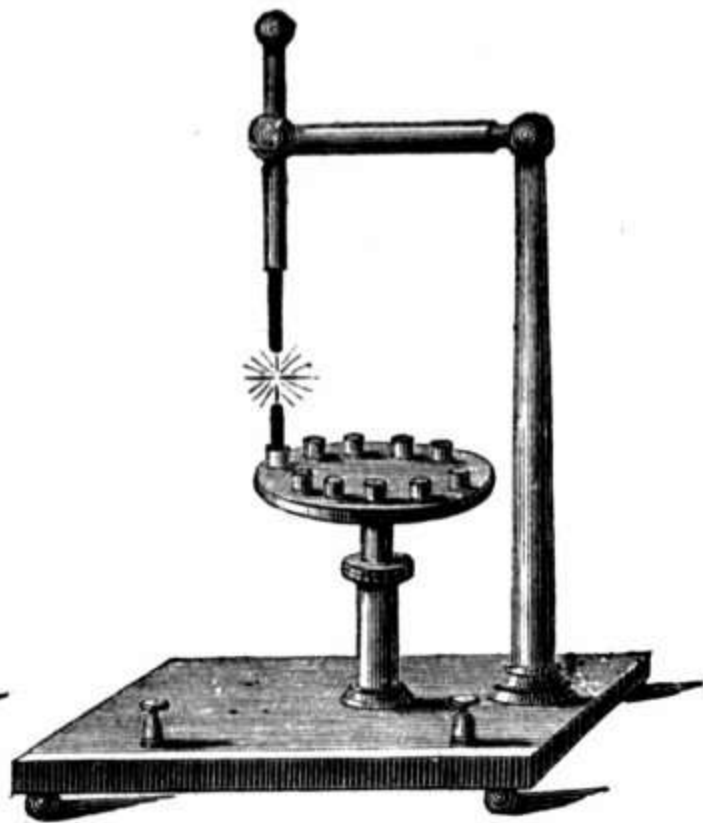

5581.

5579. Simple Electric Lamp. Base of wood, arms and holders of brass..	8 00
5580. Simple Electric Lamp. Base of hard rubber, post, arm, and carbon holders of brass.....	12 50

For complete list of Electrical Lamps, see Part 4.

SECTION X.—OF ELECTROLYSIS.

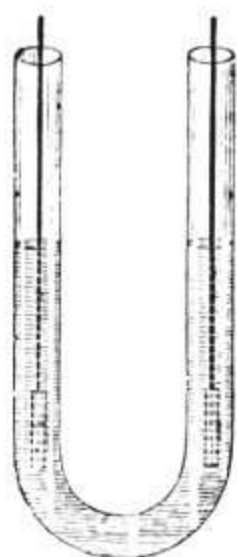

5600.



5601.

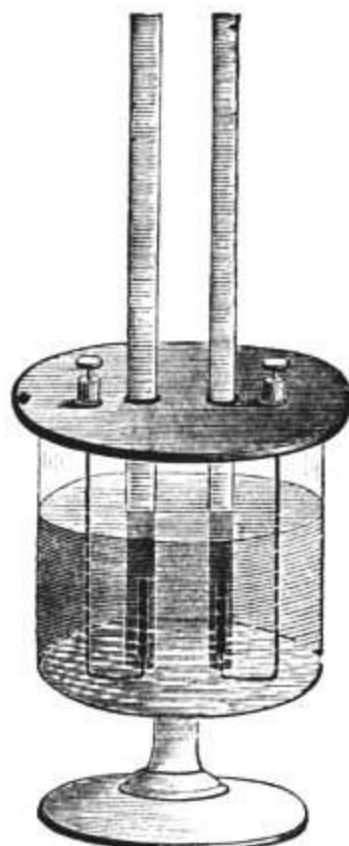

5602.

	PRICE
5600. <b>U Tube of Glass.</b> Arms 12 inches long. Insulated copper wires with bar electrodes of platinum.....	\$1 50
5601. <b>Decomposing Water Apparatus.</b> Glass goblet 6 inches high, and 3½ inches in diameter at top, with binding screws, platinum bar electrodes, and bell tubes for the gases.....	3 00
5602. <b>Decomposing Water Apparatus.</b> Glass goblet seven inches high and four and a half inches in diameter at top, with binding screws, platinum electrodes, and fine, graduated bell tubes for the gases.....	6 00
5603. <b>Decomposing Tank.</b> For use in projecting the results of electrolysis upon a screen. Plate glass sides, improved brass clamps, binding screws, platinum bar electrodes, and small glass bell tubes for the gases.....	3 00
5605. <b>Chemical Voltameter.</b> Plain glass goblet, 7 inches high, platinum bar electrodes, binding screws, and single graduated glass bell.....	6 00

SECTION XI.—ILLUSTRATING THE LAWS OF CURRENTS.

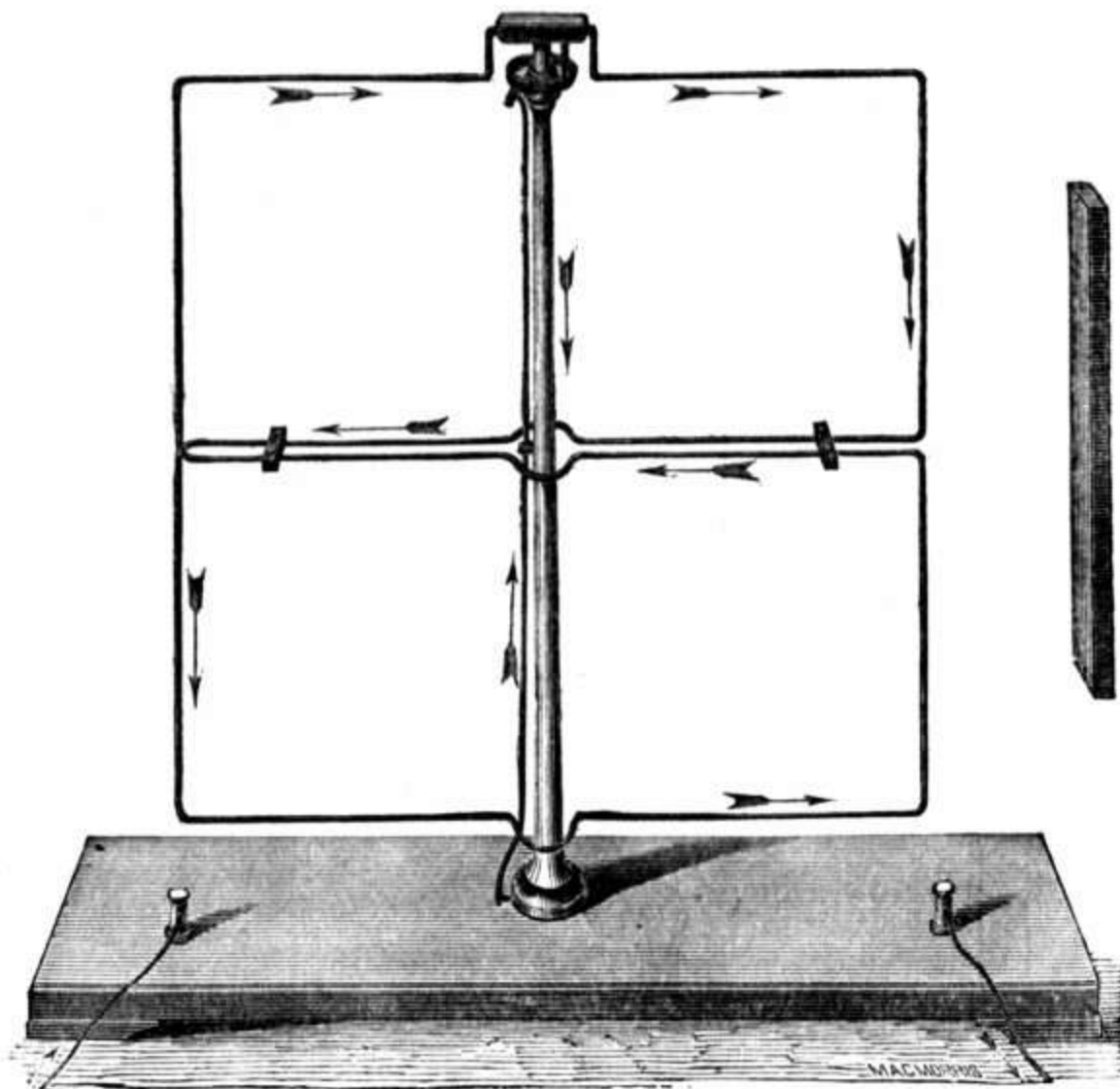

5625.

5625. **Ampere's Frame.** Base of polished mahogany, figures of copper, consisting of solenoid, astatic combination, square, and circle. With strong bar magnet. This is a new form, which requires less battery to operate it. The rotation may be continuous, and it is altogether much more satisfactory than the old arrangement.....

20 00

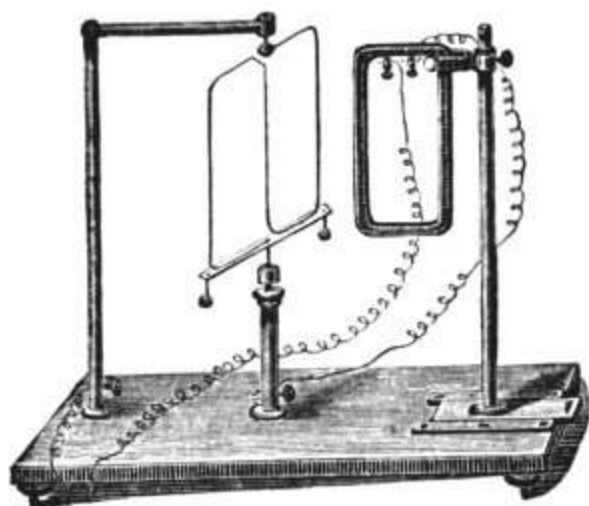

5626.

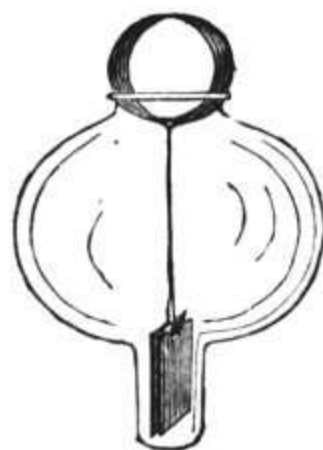

5628.

5626. **Ampere's Table.** Polished table of mahogany, two vertical posts of brass, with mercury cups at base and top for sustaining the wire forms; two forms twenty inches square of heavy wire, one to show attraction, the other repulsion. With intensifier. See cut p. 95...

\$27 00

5627. **Solenoid.** Without frame, of heavy wire, with points for suspension, as in No. 5625.....

3 00

5628. **De la Rives' Ring** .....

1 50



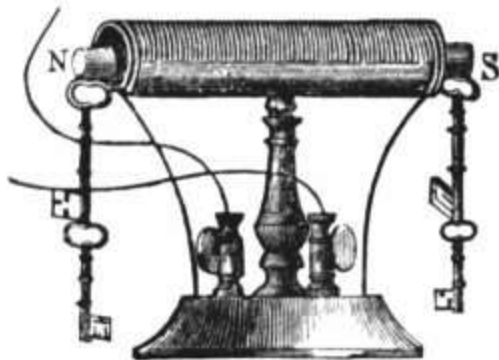

5632.

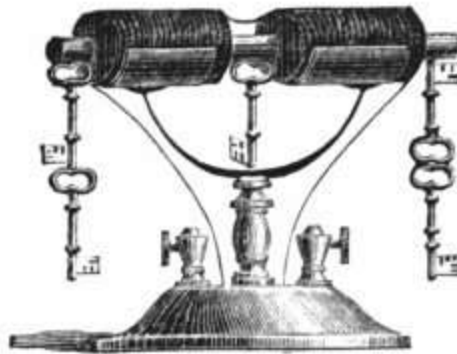

5633.



5635.

- |   |       |
|---|-------|
| 5632. <b>Helix on Stand.</b> Base of mahogany, pillar of brass, coil of insulated copper wire, with binding screws, and rod of soft iron..... | 3 00  |
| 5633. <b>Three-Pole Helix,</b> on stand, as in No. 5632.....  | 3 50  |
| 5634. <b>Horizontal Coil.</b> Twelve inches long, of insulated copper wire, on neat stand, with soft iron bar, similar to No. 5632.....       | 10 00 |
| 5635. <b>Lifting Coil.</b> Four inches long, with soft iron bar.....  | 3 00  |

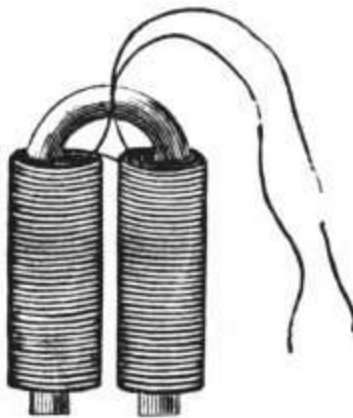

5637 and 5640.

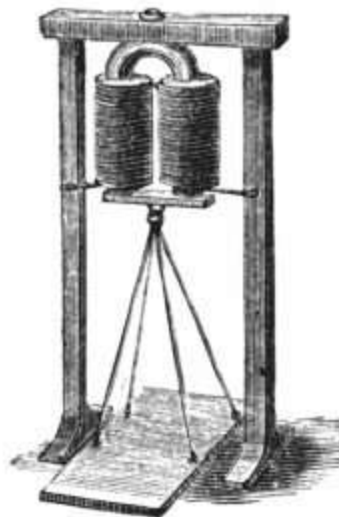

5641.



5645.

- |  |        |
|--|--------|
| 5637. <b>Electro-Magnet.</b> Three inches long, sustaining about twenty-five pounds.....   | 1 50   |
| 5638. <b>Electro-Magnet.</b> Four inches long, sustaining about forty pounds...  | 2 00   |
| 5639. <b>Electro-Magnet.</b> Five inches long, sustaining about sixty pounds...  | 2 50   |
| 5640. <b>Electro-Magnet.</b> Seven inches long, sustaining about one hundred and twenty pounds.....  | 3 50   |
| 5641. <b>Electro-Magnet.</b> Same as No. 5640, but mounted in strong frame with binding screws and armature with hook.....   | 8 00   |
| 5642. <b>Globe and Coil,</b> with magnetic and dipping needle.....   | 5 00   |
| 5645. <b>Magic Circle.</b> Two semicircular soft iron bars, with handles of brass; a hollow ring of insulated copper wire permits the semicircles to slip into it..... | \$3 50 |

5650. **Polymagnet.** A compound electro-magnet, devised for the purpose of showing to an audience as many as possible of the phenomena of magnetism and diamagnetism. (See Tyndall, Phil. Mag., vol. ix. p. 425.) Consisting of two large horseshoe electro-magnets, a helix of covered copper wire disposed between them, all mounted upon a strong mahogany base, with commutators for the currents, and supports and glass covers for the bodies to be experimented upon. Price on application.....
5651. **Apparatus** to demonstrate to a large audience that an iron bar is lengthened by the process of magnetization. Consisting of a strong base of mahogany, with two upright rods of brass three feet long, firmly set in it, and carrying a delicate apparatus consisting of a lever, connected with a mirror by a spiral spring, to magnify the amount of expansion as much as practicable. An iron bar, two feet long, and a coil of wire, eighteen inches long, serve for the magnetic excitation. Price on application.....

SECTION XII.—TELEGRAPHIC INSTRUMENTS.

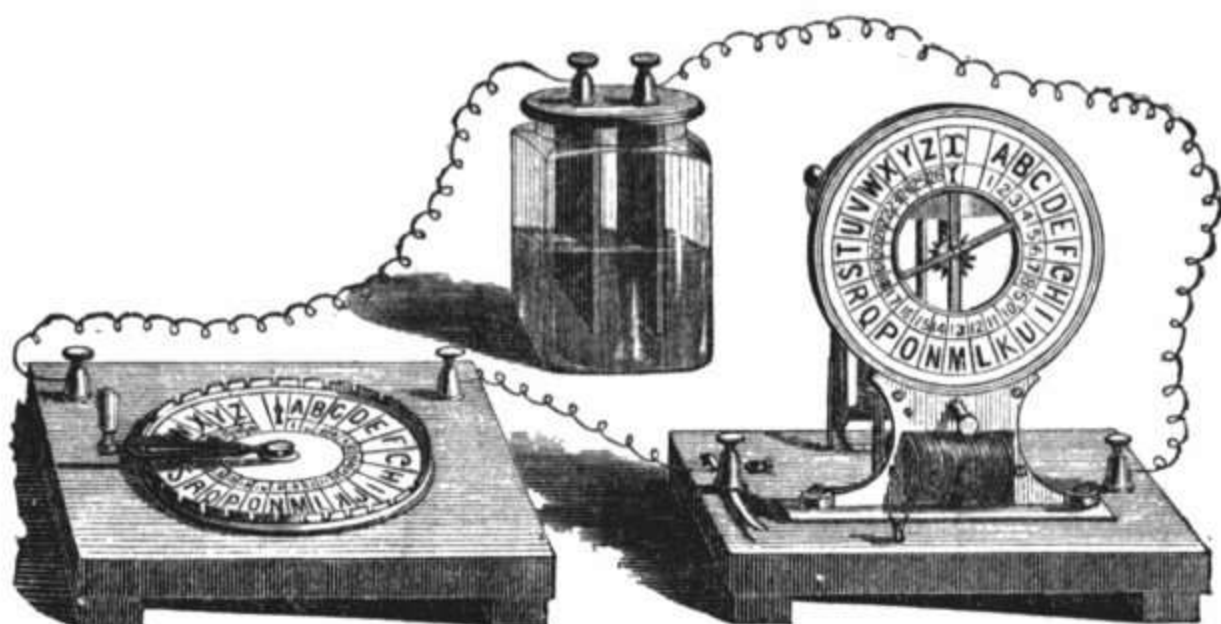

5652.

5652. **Dial Telegraph.** Consisting of a manipulator or crank, with the letters of the alphabet, for sending the signals, a bell and indicator for receiving them, and a small battery for working the instrument; all packed in a neat box ..... 15 00

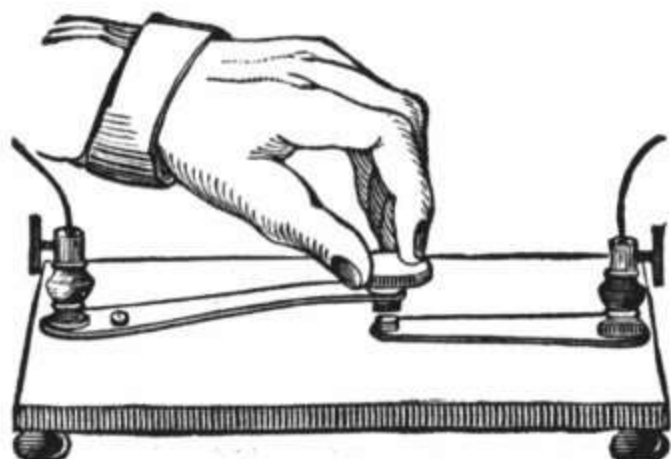

5653.

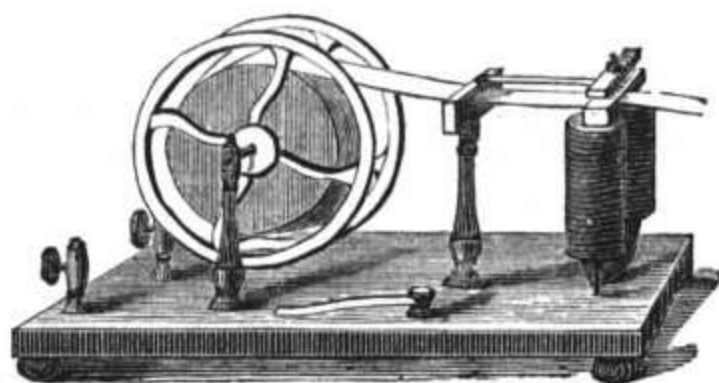

5654.

5653. **Plain Signal Key**, for closing and opening circuit..... 1 50
5654. **Plain Receiver**, Morse, without clock-work, finely finished, on polished mahogany base..... 7 00

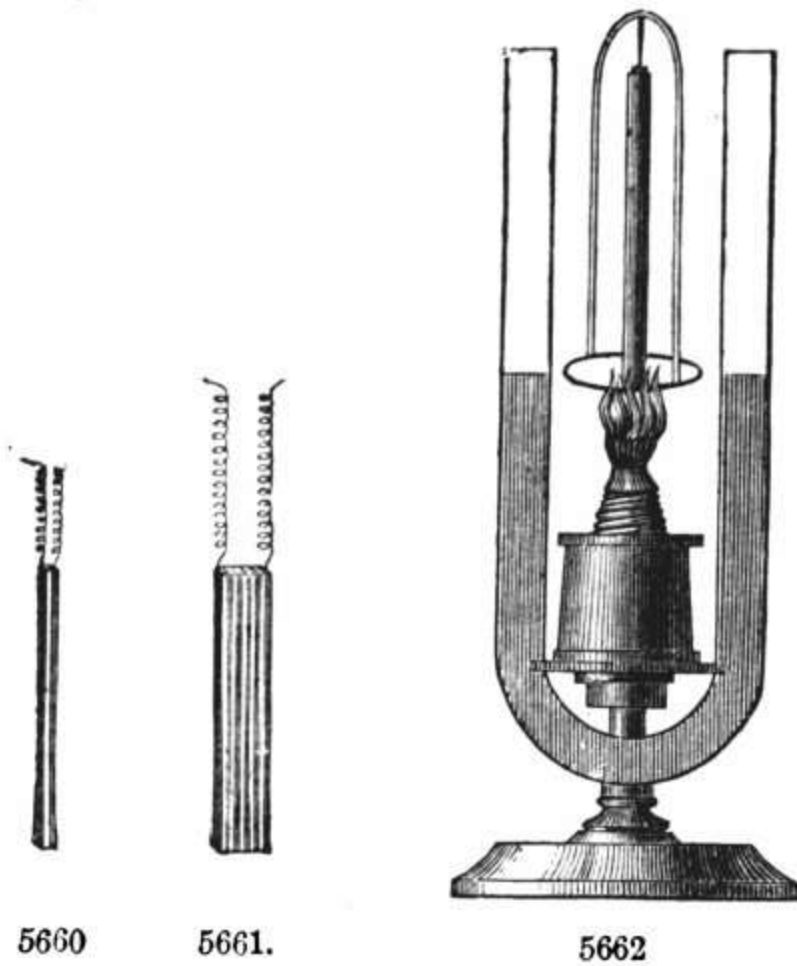

SECTION XVI.—OF THERMO-ELECTRICITY.

	PRICE
5660. <b>Pair of Elements.</b> Of brass and German silver.....	\$0 50
5661. <b>Thermo-Multiplier.</b> Five pairs of brass and German silver.....	3 00
5662. <b>Thermo-Electric Arch.</b> Consists of a permanent magnet, between the poles of which is placed an arch, the ends of which are soldered to a ring, the arch and ring by a pivot are free to turn upon the support placed between the poles ; a lamp upon a movable stand attached to the support can be raised or lowered, as may be required.....	\$5 50
5663. <b>Thermo-Multiplier.</b> Consisting of twenty-five pairs of bismuth and antimony, mounted in neat brass case, with caps, cones, and binding-screws, on an adjusting stand.....	30 00
5664. <b>Thermo-Multiplier.</b> Similar to No. 5903, but consisting of thirty-six pairs of bismuth and antimony.....	35 00
5665. <b>Thermo-Multiplier.</b> Similar to No. 5903, but consisting of forty-nine pairs of bismuth and antimony.....	40 00

SECTION XVII.—OF ELECTRO-MOTORS.

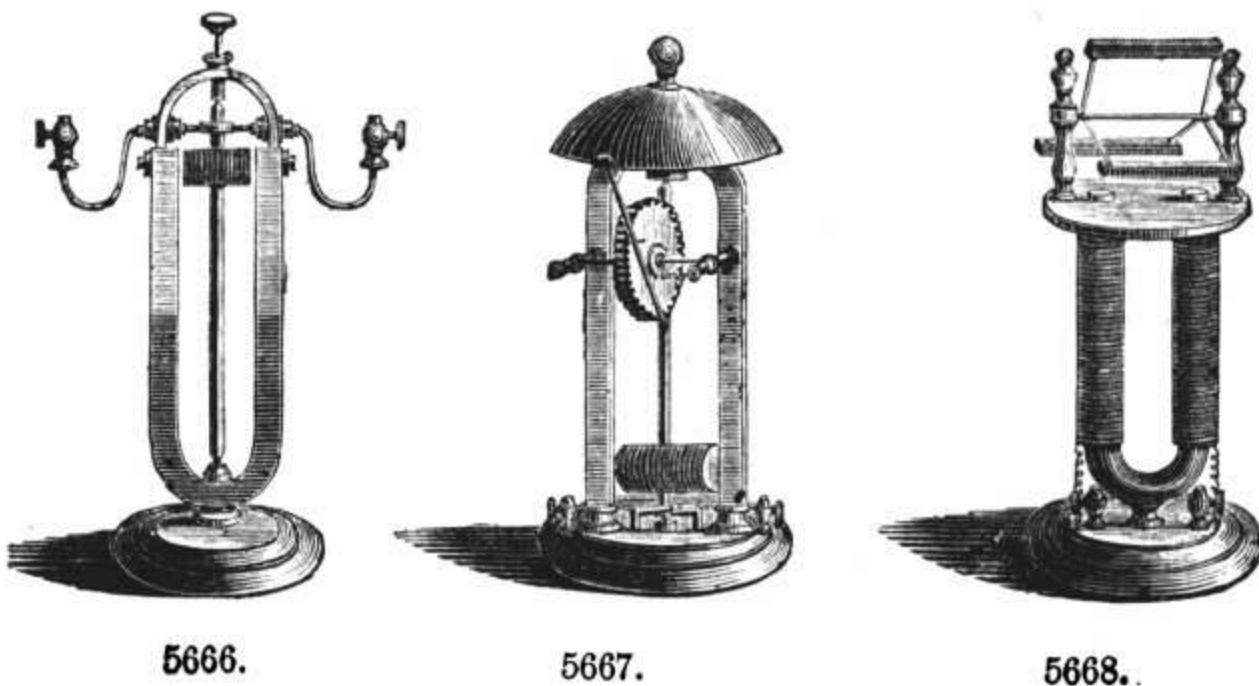

5666.

5667.

5668.

	PRICE
5666. <b>Revolving Electro-Magnet.</b> Consisting of a permanent horseshoe magnet, with an electro-magnet rotating freely upon an axis placed between its poles. ....	\$7 00
5667. <b>Bell Engine.</b> Similar to No. 5915, but with the addition of a bell, which is struck by a hammer set in motion by the electro-magnet.	10 00
5668. <b>Revolving Armatures.</b> Consisting of an electro-magnet, with a wheel carrying three soft iron armatures, rotating above the poles. ....	10 00

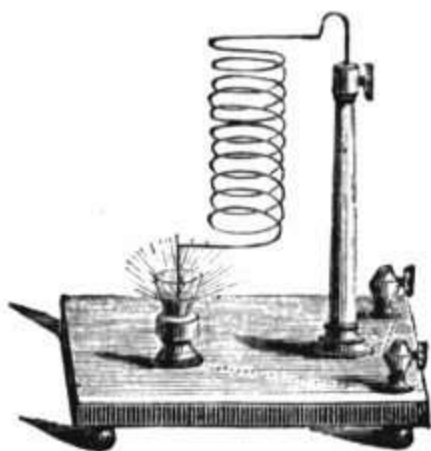

5669.

5669. <b>Contracting Helix of Copper Wire,</b> with brass pillar and mercury cup on base. ....	3 75
5670. <b>Revolving Coil.</b> A copper coil connected with binding screws, rotating between the poles of a strong permanent horseshoe magnet. ...	8 00
5671. <b>Revolving Magnet.</b> The converse of No. 5919. ....	8 00
5672. <b>Page's Reciprocating Engine.</b> ....	12 00
5673. <b>Revolving Spur-Wheel.</b> ....	10 00

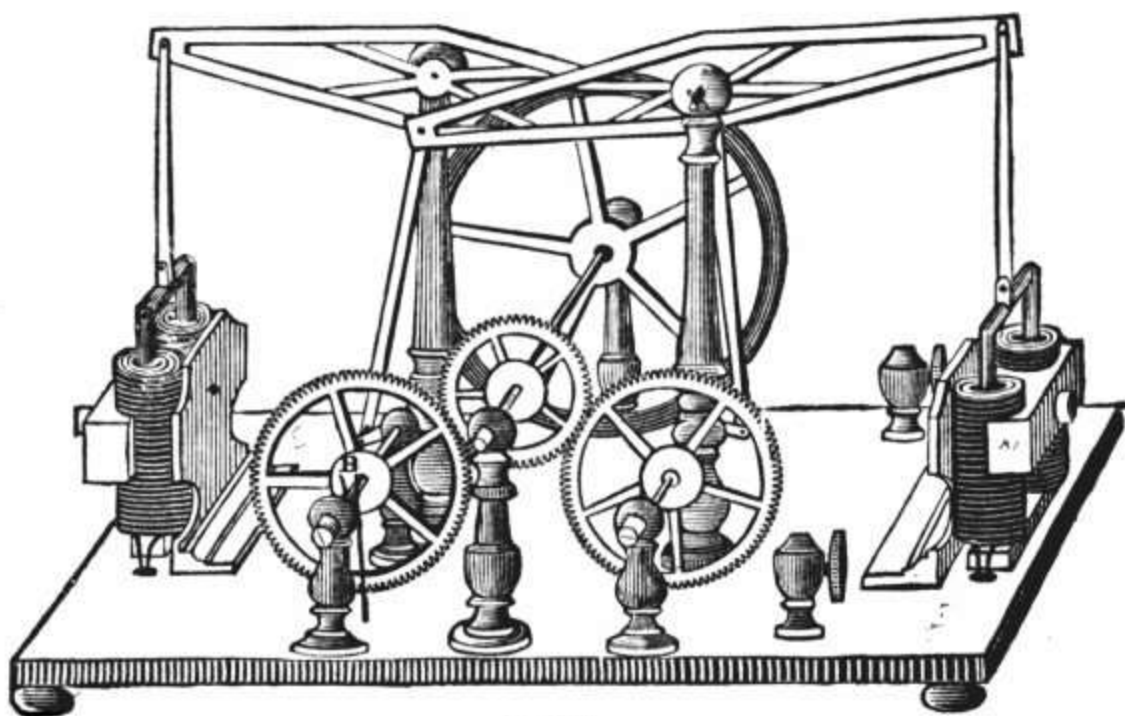

5674.

5674. <b>Double Beam Magnetic Engine.</b> ....	20 00
5675. <b>Clockwork Electrotome.</b> With copper spiral to show the intensification of the spark. Without cell. ....	15 00

**COPPER WIRE FOR CONNECTIONS.**  
**B. & S., AMERICAN GAUGE.**

No.	Bare.	Cotton covered.	Silk covered.	Office wire.
14.....	\$0.30.....	\$0.60.....	\$1.12.....	\$0.35
15.....	0.31.....	0.60.....	1.12.....	0.35
16.....	0.31.....	0.60.....	1.12.....	0.35
17.....	0.32.....	0.60.....	1.12.....	0.35
18.....	0.32.....	0.60.....	1.15.....	0.35
19.....	0.32.....	0.60.....	1.15.....	0.35
20.....	0.33.....	0.60.....	1.18.....	0.35
21.....	0.34.....	0.70.....	1.20.....	
22.....	0.38.....	0.76.....	1.30.....	
23.....	0.40.....	0.83.....	1.42.....	
24.....	0.43.....	0.90.....	1.56.....	

For full list of Wire, see Part 2, containing Electrical Test Instruments, etc.

**SECTION XIII.—OF INDUCED CURRENTS.**

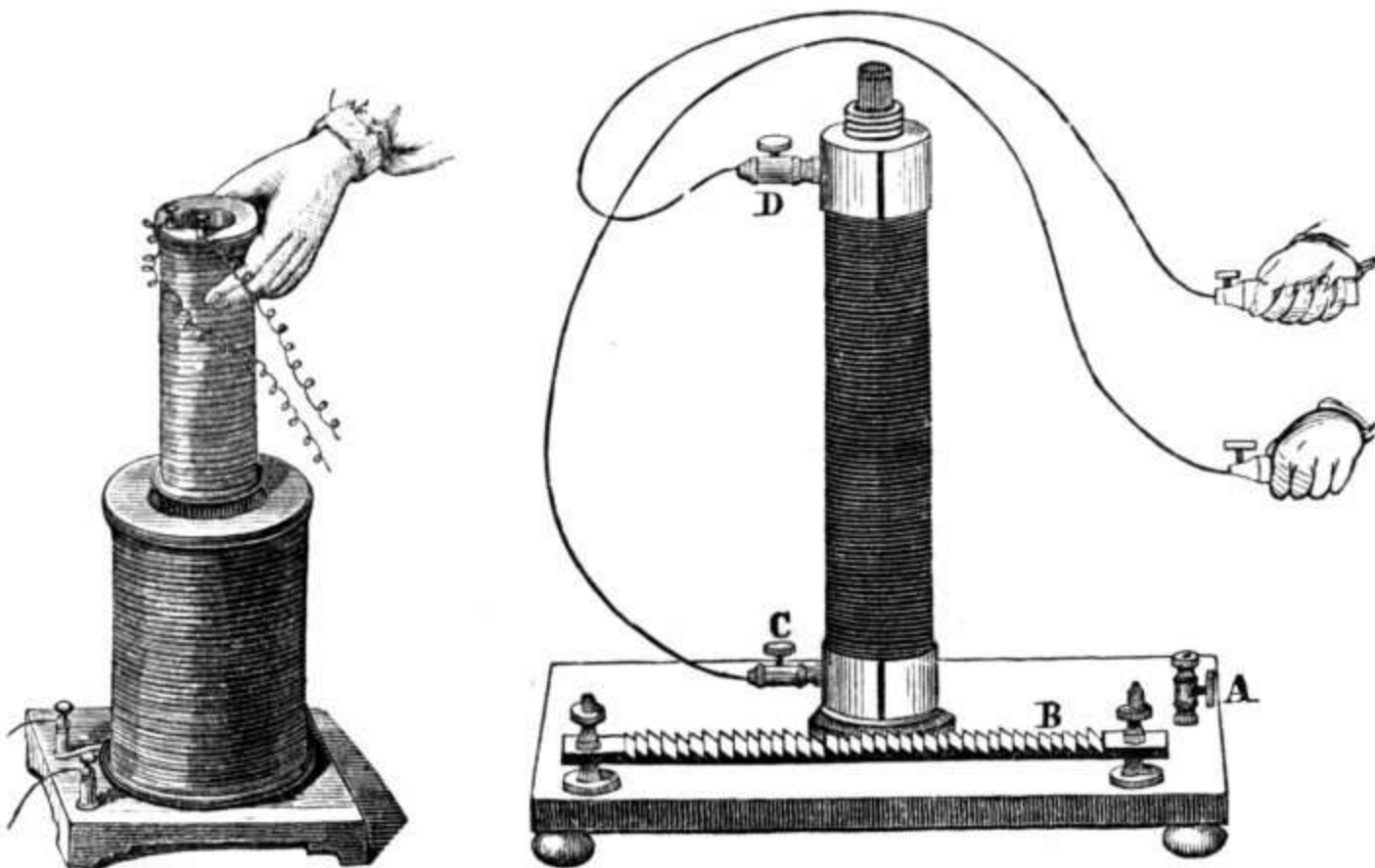

5700.

5701.

- |   | PRICE   |
|---|---------|
| 5700. <b>Primary and Secondary Coils.</b> Mounted on neat mahogany stand, with movable core of soft iron wire, for use with galvanometer...   | \$12 00 |
| 5701. <b>Primary and Secondary Coils.</b> For use in showing the physiological effects of the induced current; furnished with an automatic electro-tome, and also a rasp for slow breaks..... | 12 00   |
| 5702. <b>Portable Helix for Shocking.</b> Inclosed in a neat mahogany box, with a small cell, having six varieties of current, and a brass insulator for the soft iron core .....             | 18 00   |

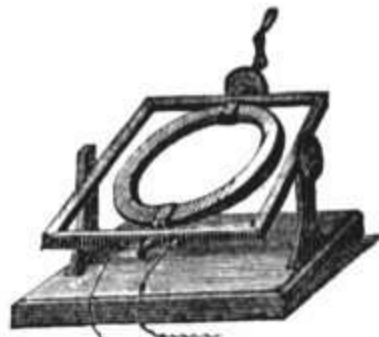

5705.

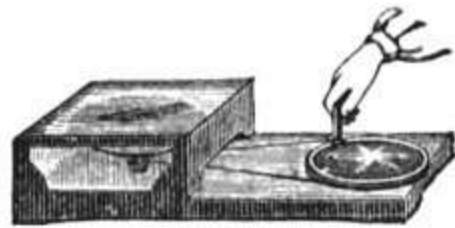

5706.

- |       |  |       |
|-------|--|-------|
| 5705. | <b>Induction Apparatus.</b> To show the induction arising from the action of the earth. Consisting of a spiral of copper wire, arranged to be turned by a crank; a commutator, and a table which can be inclined at any angle by set-screws..... | 30 00 |
| 5706. | <b>Arago's Induction Apparatus.</b> Consisting of a horizontal disc of copper, arranged to be set in rapid rotation, immediately beneath a magnetic needle.....  | 16 50 |
| 5707. | <b>Babbage &amp; Herschel's Induction Apparatus.</b> Consisting of a magnet, arranged to be set in rapid rotation, and a disc of copper supported above the magnet on a delicate pivot.....  | 23 00 |

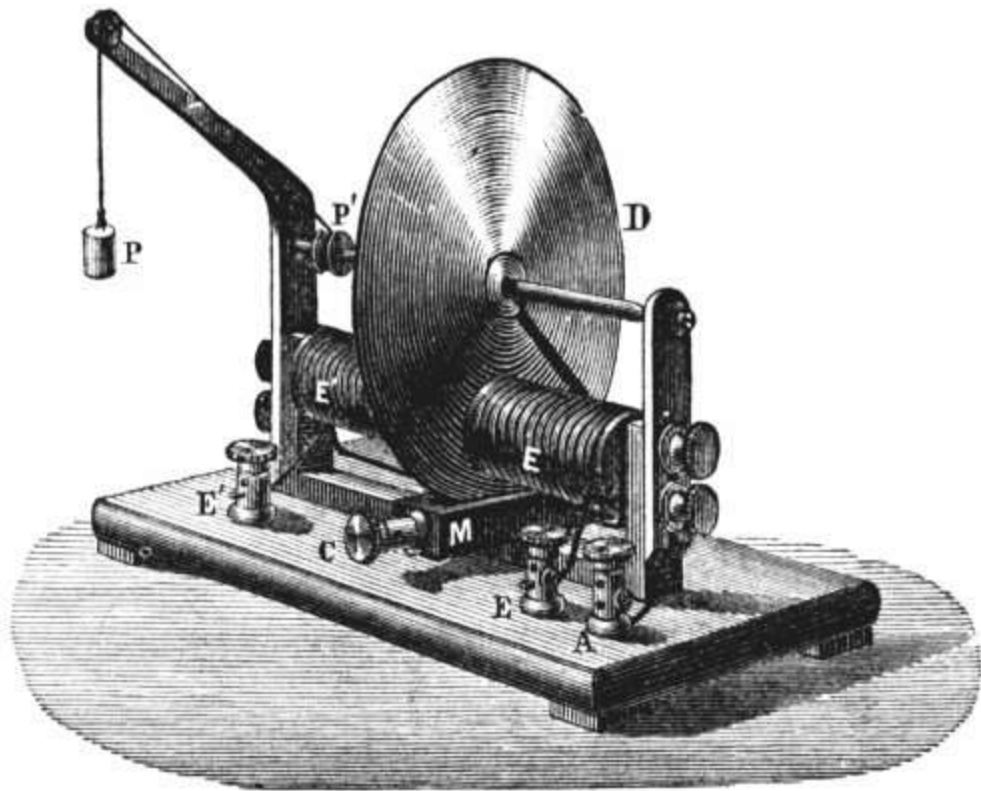

5708.

- |       |  |       |
|-------|--|-------|
| 5708. | <b>Foucault Apparatus,</b> small model, for demonstration. The disc revolving between the poles of an electro-magnet; motion is produced by the falling of a weight fixed to a cord wound upon the axis of the disc. As soon as the current passes into the electro-magnet the disc stops; when the current is broken it recovers its speed..... | 35 00 |
|-------|--|-------|

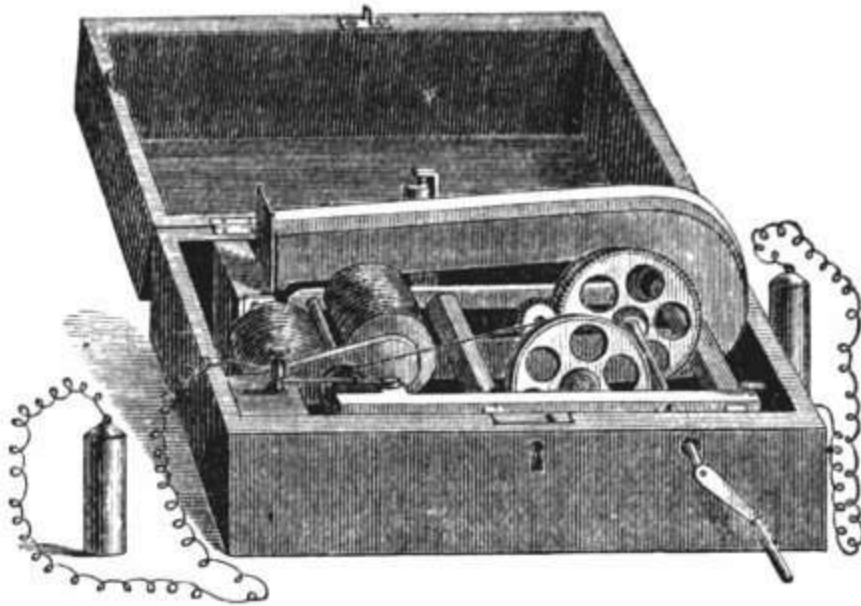

5721.

5720. <b>Clark's Induction Machine.</b> For physiological effects. Small model. A single strong magnet, one pair of spirals, for intensity, and a pair of conducting wires with handles. In neat box.....	<b>PRICE</b> \$10 00
Other sizes and styles, from.....	\$9.00 to 18 00



5723.

5723. <b>Galvanic Slippers.</b> Per pair.....	1 50
5724. <b>Insulated Handles.</b> Per pair.....	2 00

SECTION XIV.—THE RUHKORFF, OR INDUCTION COIL.

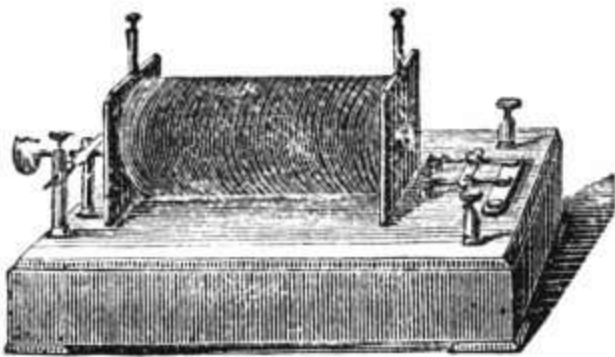

5726-27.

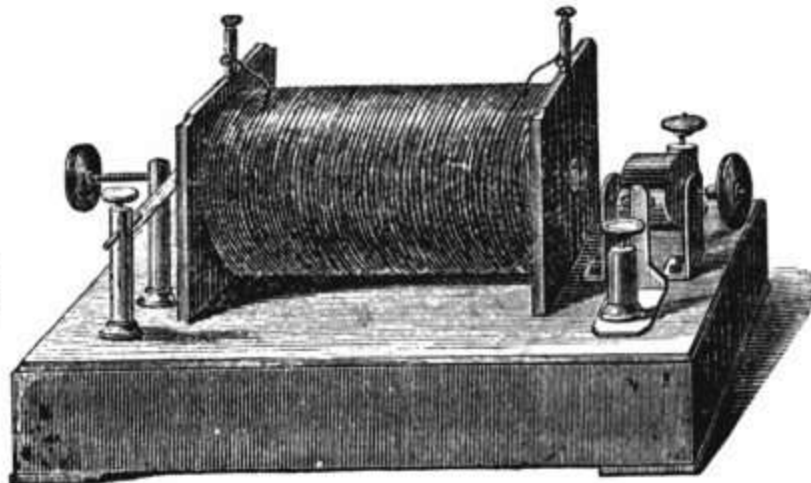

5728-34.

	PRICE
5726. <b>Induction Coil.</b> With automatic break, giving spark about $\frac{1}{8}$ inch in length, on neat mahogany base.....	\$6 00
5727. Induction Coil. Similar to No. 5726, but with plain commutator, giving spark of about $\frac{1}{4}$ -inch .....	8 00
5728. Improved Induction Coil. With automatic break, new and improved commutator, on neat mahogany base with rubber cover, and mountings, giving spark of $\frac{3}{8}$ -inch.....	12 00
5729. Induction Coil. Similar to No. 5728, but giving $\frac{1}{2}$ -inch spark .....	20 00
5730. Induction Coil. Similar to No. 5728, but giving spark of $1\frac{1}{2}$ inches...	35 00
5731. Induction Coil. Similar to No. 5728, but giving spark of $1\frac{3}{4}$ inches...	50 00
5732. Induction Coil. Similar to No. 5728, but giving spark of $2\frac{1}{2}$ inches...	75 00
5733. Induction Coil. Similar to No. 5728, but giving spark of 4 inches....	125 00
5734. Induction Coil. Similar to No. 5728, but giving spark of 6 inches...	

## QUEEN'S NEW DISSECTED RUHMKORFF COIL.

—♦—

The principal advantages of our new form of Induction Coil, are, that it is so constructed that it can be readily dissected or taken apart, without at all injuring its efficiency as a good practical instrument, and that the connections are all placed on the top of the mahogany case; the student can thus readily trace the course of the electrical current. For purposes of demonstration this form is far more valuable than the one usually sold.

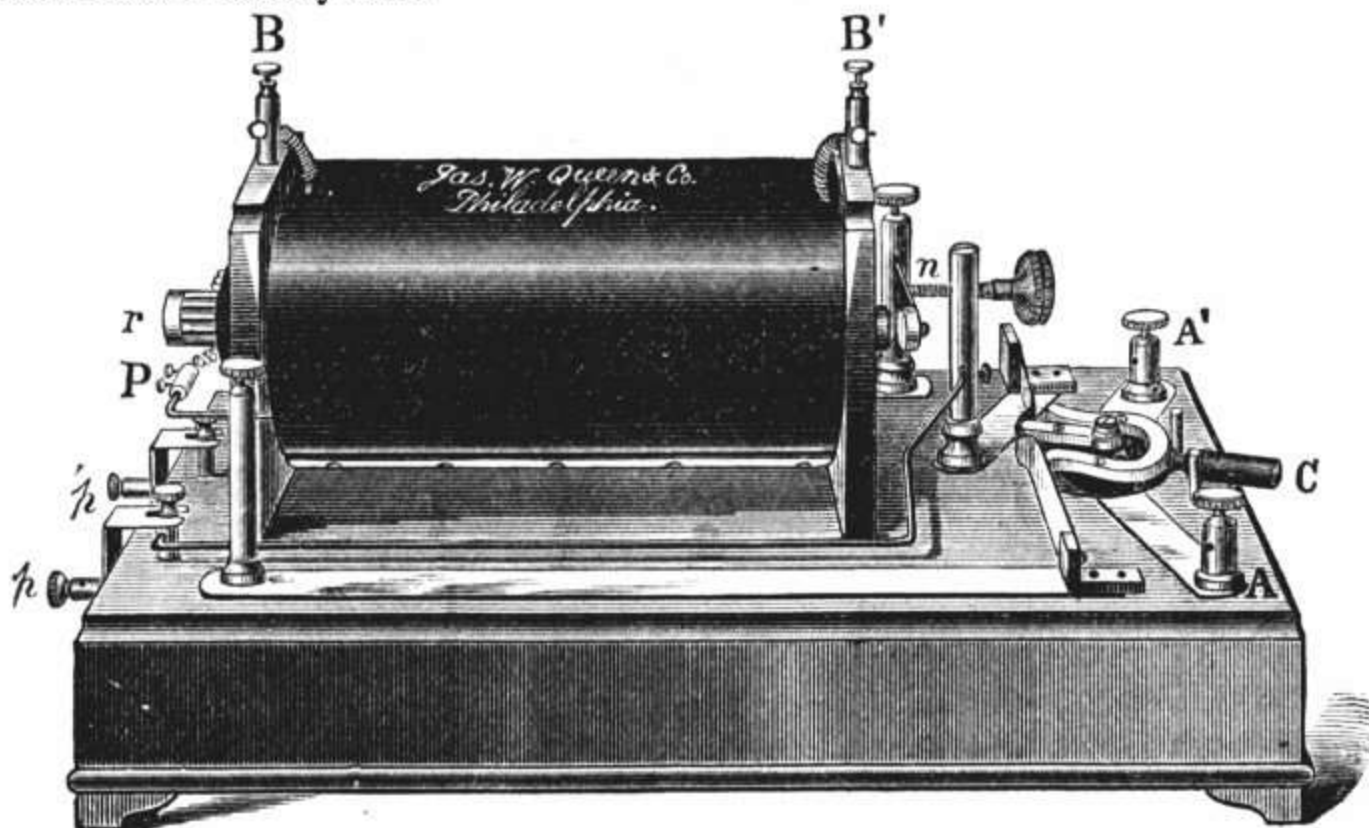

5740-44.



A A' are binding posts, to connect with the battery; C is the new Bertin Com- mutator for reversing the current; at P, the battery current enters the primary coil; this latter can be removed for demonstration, as also can the core r; at n, the battery current is automatically broken.

The brass plates p p', connect the condenser with the primary circuit; the con- denser is contained in a sliding drawer, which can be easily removed.

B B' are the terminals of the secondary coil.

The coils are encased in hard rubber, the base is mahogany finely polished, the connections are copper and brass all elegantly finished.

5740. Queen's Dissected Ruhmkorff Coil, No. 1, giving sparks of 30 mm. (about 1½ in.).....	\$45 00
5741. Queen's Dissected Ruhmkorff Coil, No. 2, giving sparks of 40 mm. (about 1¾ in.) .....	62 00
5742. Queen's Dissected Ruhmkorff Coil, No. 3, giving sparks of 60 mm. (about 2¾ in.).....	90 00
5743. Queen's Dissected Ruhmkorff Coil, No. 4, giving sparks of 100 mm. (about 4 in.).....	145 00
5744. Queen's Dissected Ruhmkorff Coil, No. 5, giving sparks of 150 mm. (about 6 in.).....	175 00

We can furnish these, duty free, to Educational Institutions.

**RUHMKORFF COILS.**

*This list comprises the Coils made by the celebrated maker, "Ruhmkorff," and are imported to order.*

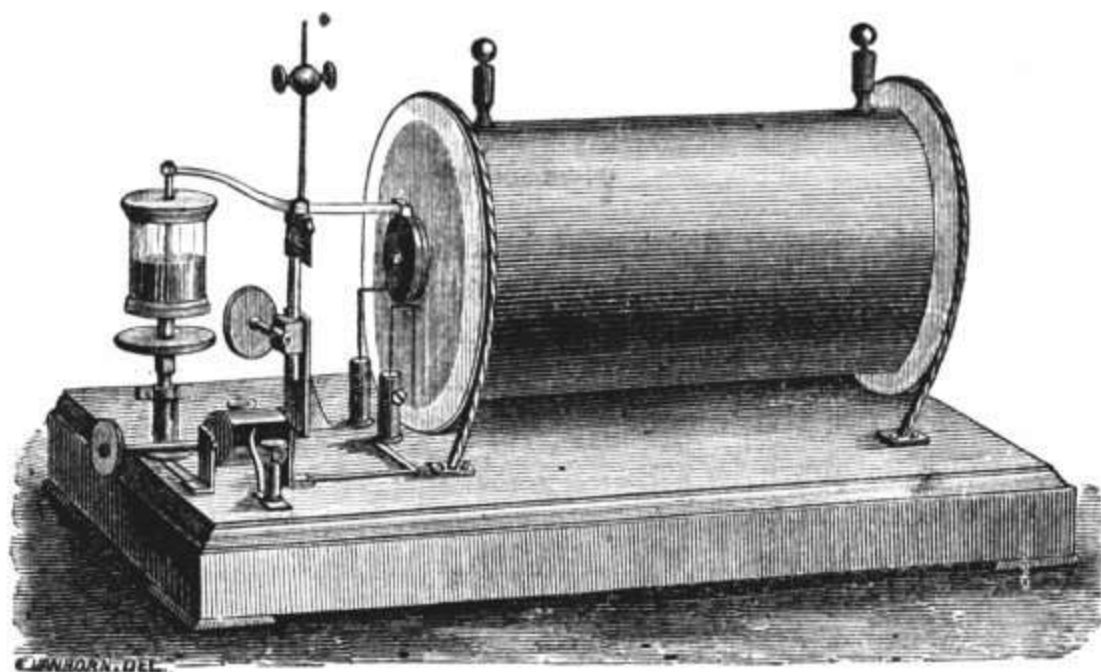

5750 and 5752.

5750. Induction Coil. Highest style of finish and perfection of construc- tion, wound in sections, having Deprez break; spark 30 mm.....	150 fr.
5751. Induction Coil. Similar to No. 5750; spark 60 mm.....	800 fr.
5752. Induction Coil. Similar to No. 5750, but furnished also with Fou- cault interrupter, giving sparks of 12 cm and 20 cm respectively...	600 fr.

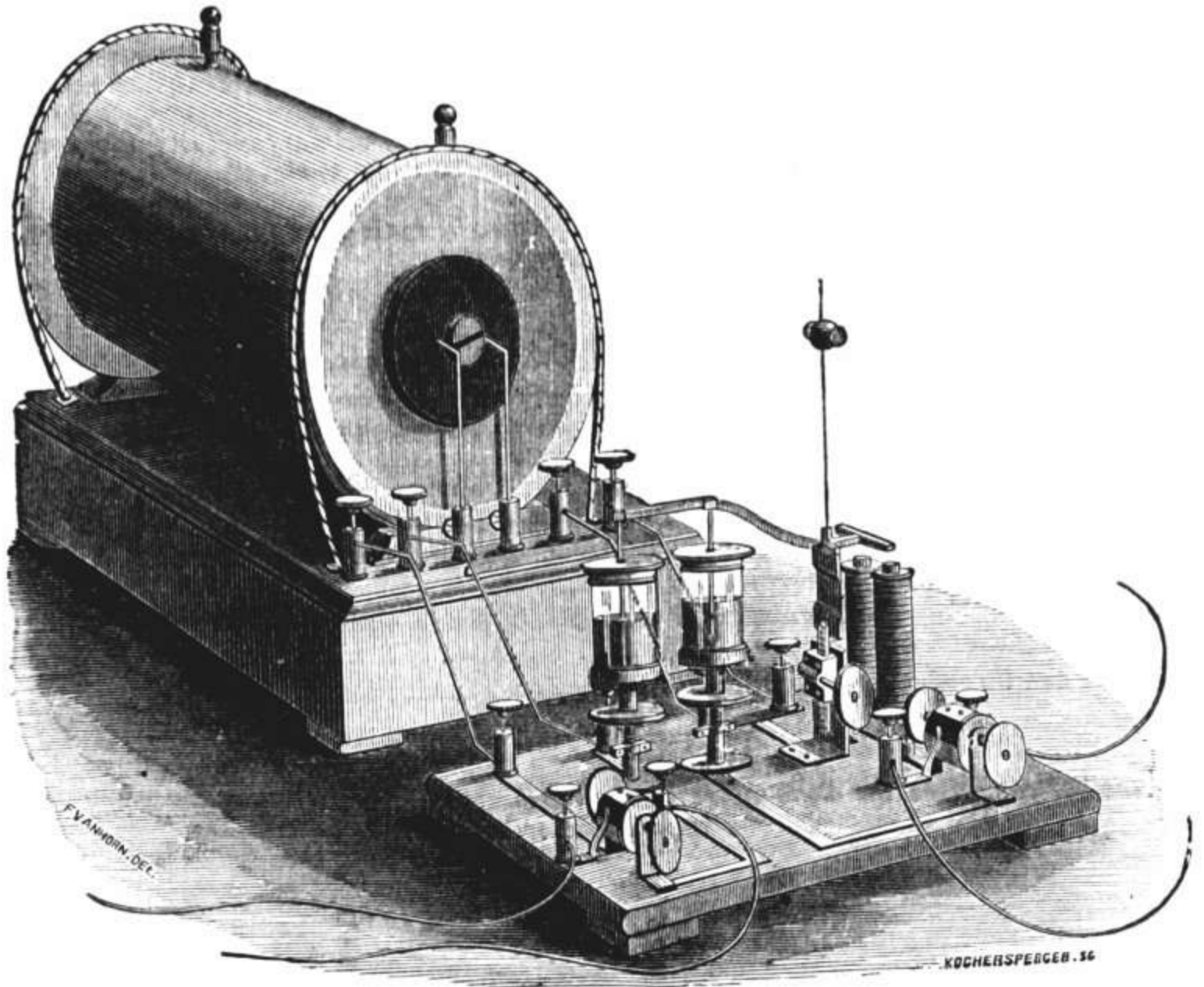

5753-58.

5753. Induction Coil. Finest finish and best construction, wound in sections, with Foucault interrupter on separate stands; spark 30 cm....	1000 fr.
5754. Similar to 5753; spark 35 cm.....	1250 fr.
5755. Similar to 5753; spark 40 cm.....	1500 fr.
5756. Similar to 5753; spark 45 cm.....	1750 fr.
5758. Similar to 5753; spark 50 cm.....	2000 fr.
5760. Foucault Interrupter.....	150 fr.
5765. Coil for Lenvir Motor.....	135 fr.

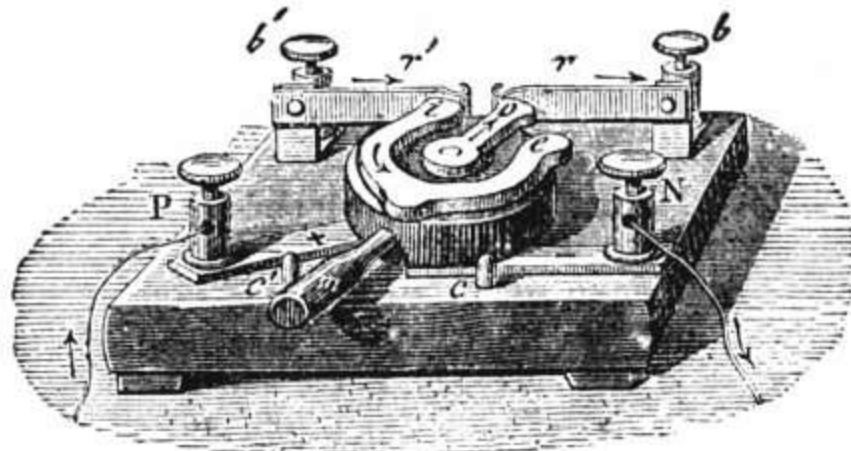

5770.

5770. Bertin's Commutator. By its use the operator can always be certain of the direction of the current.....	12 50
---	-------

SECTION XV.—OF GEISSLER, CROOKES, AND SPECTRUM TUBES.

GEISSLER'S TUBES.

Geissler's Tubes or Vacuum Tubes consist of closed glass tubes with platinum wires or electrodes, sealed in each end; they contain a highly rarefied vapor or gas, exhausted so that the pressure does not exceed half a millimeter, when a discharge from a Ruhmkorff Coil or Holtz Machine is passed through one, the whole tube is filled with a bright light, the color and brilliancy of the electric discharge depends upon the nature of the residual gas in the tube. The various phenomena connected with the subject of electric discharges in rarefied gases, have been investigated by Masson, Grove, Gassiot, Plucker, Spottiswoode, De La Rue and Müller. The Tubes admit of almost an endless variety of designs, some of which are very elaborately made in order to bring out striking contrasts of color. These beautiful effects are further heightened and rendered more brilliant by filling different parts of the same tube with a variety of gases, and by the use of uranium glass, which glows with a beautiful green light; fluorescent solutions of Sulphate of Quinine, Alcoholic solutions of Stramonium, solutions of Æsculine, Amidoterephthalate of Ethyl, etc., etc., add great beauty to the tubes. Phosphorescent gases and solids contained in these tubes show remarkable effects. The bulb at the end which is most strongly illuminated is the one connected with the negative electrode. The gases most frequently used in these tubes are Hydrogen, Nitrogen and Carbonic Acid, Bromine, etc., etc.

The increasing interest in the study of electrical discharges in high vacua, has induced us to make colored lithographs of our principal forms of Geissler's Tubes and Spectrum Tubes. These drawings have been taken directly from the tubes at a great expense; they can give but a faint idea of the actual beauty of the original. Geissler's Tubes require a Ruhmkorff's Induction Coil or Holtz Machine for their exhibition.

Most works on Physics give instructions how to use Geissler's Tubes; however, the following little book may be found useful, "Induction Coils, how made and how used," price fifty cents.

	PRICE.
Nos. 1, 2, 3, 4, 5, 6, Plain or Spiral Tubes of different forms and containing various gases, about 6 inches long, each . . . . .	\$0 75
Nos. 7, 8, 9, 10, 11, Tubes with Bulb, etc., of Uranium Glass, which becomes fluorescent on the passage of the electric discharge, about 6 inches long, each . . . . .	1 00
Nos. 12, 13, 14, 15, 16, 17, 18, 19, 20, Tubes with Uranium Glass Bulbs, Spirals, etc., 7 to 8 inches long, finely finished, each . . . . .	1 25
Nos. 21, 22, 23, 24, 25, 26, 27, 28, 29, 30, 31, Tubes partly of fluorescent Uranium Glass, about 7 inches long and more elaborately shaped than the above, each . . . . .	1 50
Beautiful and curious devices may be arranged by fastening a series of these tubes, by means of fine copper wire, to a velvet lined board.	
Nos. 32, 33, 34, Double Tubes, about 7 inches long, one within the other, inner one with Uranium Glass Bulbs or Spirals, each . . . . .	3 00
Nos. 35, 36, 37, 38, Double Tubes, about 7 inches long, inner one with Uranium Spirals, etc., outer one filled with a fluorescent solution, each . . . . .	3 00
Nos. 45, 46, 47, 48, 49, Single Tubes, about 13 inches long, with Bulbs and Spirals of Uranium Glass, very beautiful, each . . . . .	3 75
Nos. 50, 51, 52, 53, 54, 55, 56, Double and Single Tubes, both with and without fluorescent solutions, about 13 inches long, elegantly finished, with Uranium Vases, Spirals, etc., etc., each . . . . .	4 50

	PRICE
Nos. 57, 58, 59, 60, 61, Double Tubes, about 11 inches long, with various patterns of Uranium Glass, fluorescent solutions, etc., very fine, each,	\$3 75
No. 62, Compound Volute Tube, about 6 inches high, containing a Uranium Volute, the large globe is filled with a fluorescent solution . . . . .	3 75
Nos. 63, 64, U Tubes, double, with Uranium Spirals, and different fluorescent solutions in each arm, about 9 inches high, with stands, each . . . . .	5 00
No. 70, Tube, about 12 inches high, containing Uranium Cross, with stand . .	5 00
No. 70a, Tube, similar to the above, but about 16 inches high. Large and fine, with stand . . . . .	9 00
No. 71, Tube, about 12 inches high, containing within it a beautiful Glass Harp and Uranium Vase, with case . . . . .	5 00
No. 71a, Tube, similar in design to No. 71, but 18 inches high, with stand . .	11 00
No. 72, Phosphorescent Tube, in which no coil is needed, but the light is evolved, by the friction of mercury falling upon globes of glass, within an exhausted tube, each . . . . .	4 50
No. 72a, Same as No. 72, but larger, and with bulbs of Uranium Glass in the inner tubes . . . . .	6 50
No. 73, Tube, about 12 inches high, containing beautiful Uranium Rosette, the globe is filled with a fluorescent solution . . . . .	6 00
No. 74, Tube, about 6 inches high, with Uranium Pitcher, with stand. . . . .	3 00
No. 74a, Same as No. 74, but about 12 inches high . . . . .	6 00
No. 74b, Same as No. 74, but about 14 inches high . . . . .	9 00
No. 75, Tube, with triple Gassiot's Cascade, of Uranium Glass, about 16 inches high. . . . .	10 50
No. 75a, Tube, with Vase of Uranium to show as Gassiot's Cascade, about 14 inches high. . . . .	6 00
No. 76, Geissler's Tubes, containing Head of Chinaman. . . . .	6 00
No. 78, U Geissler's Tube, about 20 inches high, on neat base, with Uranium Spirals and Bulbs, very beautiful. . . . .	8 50
No. 79, U Geissler's Tube, about 20 inches high, on neat base, with Uranium Coils, Bulbs, etc. . . . .	8 50
Nos. 85, 86, Double Geissler's Tubes, about 32 inches long, containing Uranium Spirals, Bulbs, etc., with two fluorescent solutions . . . . .	15 00
No. 87, Double Geissler's Tube, about 32 inches long, with bent Uranium Tubes and Bulbs, with fluorescent solution. . . . .	14 50
No. 88, Double Geissler's Tube, about 32 inches long, with Spirals of Uranium Glass, either with or without fluorescent solution . . . . .	15 00
No. 88a, Same as No. 88, but 24 inches long . . . . .	9 50
No. 89, Double Geissler's Tube, about 32 inches long, with Glass Spiral, half white and half colored glass, with fluorescent solution . . . . .	15 00
No. 90, Induction Tubes; a double Tube, about 24 inches long, the inner Spiral Tube of Uranium Glass, becomes luminous by being held near an excited electric body, or by being itself rubbed on the outside by flannel or fur. . . . .	6 00
No. 90a, Induction Tubes, similar to No. 90, 30 inches long . . . . .	8 00
No. 90b, Induction Tube, similar to No. 90, but with concentric Spirals of Uranium Glass, about 36 inches long . . . . .	12 00
No. 90c, Induction Tube, similar to No. 90, about 37 inches long, with three Uranium Spirals, very fine. . . . .	14 00
No. 91, Geissler's Tube, straight, 12 inches long, beautifully stratified . . .	2 25
No. 91a, Geissler's Tube, similar to No. 91, but about 24 inches long . . . .	4 50
No. 92, Phosphorescent Geissler's Tube, double, filled, with two phosphorescent powders, about 13 inches long . . . . .	5 00
No. 92a, Geissler's Tube, similar to No. 92, but with four different phosphorescent powders, about 22 inches long . . . . .	9 00
No. 92b, Geissler's Tube, similar to No. 92, but with one phosphorescent powder, and about 8 inches long . . . . .	2 50
No. 100, Double Gassiot's Cascade Tube; this fine tube has two Uranium Vases, two beautiful fluorescent solutions, a fine Rosette in the centre, the effect is very beautiful . . . . .	30 00

PRICE.

- No. 101, *Curved* Phosphorescent Geissler's Tube, with 7 bulbs; this beautiful Tube contains a phosphorescent gas, which remains distinctly luminous for several seconds after the electric current has ceased to pass; 14 inches long. . . . . \$8 00
- No. 101a, Phosphorescent Geissler's Tube, similar to No. 101, but larger . . . 10 00

PLÜCKER'S OR SPECTRUM TUBES,

Having traces of the several elements mentioned below, and to be used with the Induction Coil and the Spectroscope. The late solar researches render these Tubes invaluable to the teacher and physicist.

- |   |                       |                           |                          |
|---|-----------------------|---------------------------|--------------------------|
| } | 102                   | 1. Oxygen.                | 10. Fluoride of Silicon. |
|   | 2. Hydrogen.          | 11. Cyanogen.             |                          |
|   | 3. Nitrogen.          | 12. Chloride of Tin.      |                          |
|   | 4. Carbonic Oxide.    | 13. Ammonia.              |                          |
|   | 5. Carbonic Acid.     | 14. Vapor of water.       |                          |
|   | 6. Iodine.            | 15. Mercury.              |                          |
|   | 7. Chlorine.          | 16. Sulphur.              |                          |
|   | 8. Bromine.           | 17. Selenium.             |                          |
|   | 9. Fluoride of Boron. | 18. Sulphuret of Mercury. |                          |
|   | Each . . . . .        |                           | 2 00                     |

Many of these Tubes give most brilliant results, also, when used as Geissler's Tubes. Nothing finer indeed can be found in this line than the Tubes containing Hydrogen, Nitrogen, Iodine, Chloride of Tin, Fluoride of Boron, and Fluoride of Silicon.

- No. 103, Geissler's Tube, crown shaped, 16 inches in diameter, contains a phosphorescent gas, very fine. . . . . 12 00
- No. 103a, Phosphorescent Geissler's Tube, same as No. 103, but 6 inches in diameter, 6 bulbs. . . . . 5 00
- No. 104, New End on Spectrum Tubes.

Prof. Piazzzi Smyth, in an article entitled "End on in Place of Transverse Illumination in Private Spectroscopy," says, that "in a narrow and critical region of a rather faint and difficult carbonaceous spectrum, where the Royal Society, London, has published eight lines only, and those dark ones, *the New Tubes* showed thirty-one lines, and all of them bright ones. Dr. Van Monckhoven states that the new end on Spectrum Tubes give about 100 times more light than the ordinary Spectrum Tubes. To these brilliant results we would especially call the attention of scientists. The intense light referred to above is obtained by the use of a Ruhmkorff Coil."

We have prepared the following tubes having traces of the several elements mentioned below and to be used with the Induction Coil and the Spectroscope. We can furnish tubes containing other gases to order.

- |                           |                                     |      |
|---------------------------|-------------------------------------|------|
| 1. Oxygen.                | 14. Nitrous Acid.                   |      |
| 2. Hydrogen.              | 15. Nitric Oxide.                   |      |
| 3. Nitrogen.              | 16. Hydrochloric Acid.              |      |
| 4. Carbonic Oxide.        | 17. Fluoride of Silicon.            |      |
| 5. Carbonic Acid.         | 18. Cyanogen.                       |      |
| 6. Iodine.                | 19. Chloride of Tin.                |      |
| 7. Chlorine.              | 20. Ammonia.                        |      |
| 8. Bromine.               | 21. Vapor of Water.                 |      |
| 9. Fluoride of Boron.     | 22. Mercury.                        |      |
| 10. Alcohol.              | 23. Sulphur                         |      |
| 11. Ether.                | 24. Selenium.                       |      |
| 12. Carburetted Hydrogen. | 25. Sulphuret of Mercury, Etc., &c. |      |
| 13. Hydrogen Cyanide.     |                                     |      |
| Each . . . . .            |                                     | 3 25 |

## PLUCKER OR SPECTRUM TUBES.

Containing list of tubes filled with rare and unusual compounds. Furnished to order only.

H <sub>2</sub> S. Hydrogen Sulphide.	Acetic Ether.
C <sub>2</sub> H <sub>4</sub> . Olefiant Gas.	HC <sub>2</sub> H <sub>3</sub> O <sub>2</sub> . Acetic Acid.
Paris Lighting Gas.	C <sub>6</sub> H <sub>6</sub> . Benzine.
CS <sub>2</sub> . Carbon Bisulphide.	C <sub>10</sub> H <sub>10</sub> . Oil of Turpentine.
SiCl <sub>4</sub> . Chloride of Silicon.	C <sub>10</sub> H <sub>16</sub> O. Camphor.
NaCl. Chloride of Sodium.	C <sub>10</sub> H <sub>8</sub> . Naphthaline.
BaCl <sub>2</sub> . Chloride of Barium.	C <sub>2</sub> HCl <sub>3</sub> O. Chloral.
S <sub>2</sub> Cl <sub>2</sub> . Chloride of Sulphur.	CHCl <sub>3</sub> . Chloroform.
Chloride of Phosphorus.	As <sub>2</sub> O <sub>3</sub> . Arsenic.
C <sub>2</sub> H <sub>4</sub> O. Aldehyde.	H <sub>2</sub> SO <sub>4</sub> . Sulphuric Acid.
CH <sub>4</sub> O. Methylic Alcohol.	Air, pure.
(C <sub>2</sub> H <sub>5</sub> )O. Ether.	

This is a partial list. We can furnish some fifty gases in all.

No. 105, Geissler's Apparatus for illustrating the "Rotation of Induced Currents by Magnets." It is permanently exhausted . . . . .	\$10 00
No. 106, Absolute Vacuum Tube; the vacuum is so perfect, that the spark of a good-sized Induction Coil will not pass between the poles, although they are only one-sixteenth of an inch apart . . . . .	7 00
No. 110, Double Geissler's Tube, with two gases, about 18 inches long. . . . .	6 50
No. 110a, Double Geissler's Tube, same as No. 110, but about 23 inches long, . . . . .	8 50
No. 111, Geissler's Tube, crown-shaped, with 12 fluorescent Uranium bulbs; the centre contains a beautiful star and Uranium spiral . . . . .	8 00
No. 112, Large Straight Geissler's Tube, about 30 inches high, with a beautiful Uranium rosette in the centre, with Stand . . . . .	15 00
No. 113, Geissler's Tube, similar to No. 112, but with 2 rosettes or Uranium spirals . . . . .	17 00
No. 114, Double Geissler's Tube, with 2 gases, on Stand . . . . .	4 50
No. 115, Double Geissler's Tube, gases . . . . .	6 50
No. 120, Large Stratification Geissler's Tube. This elegant Tube is 55 inches long, and has three bulbs, the largest of which is nearly six inches in diameter. The stratification shows very distinctly over a large room . . . . .	30 00
No. 121, Triple Bulb Geissler's Tube, each one filled with different gas, about 50 inches long; very fine . . . . .	30 00
No. 122, Queen's New Geissler's Tube, about 55 inches long. This magnificent Tube is one of the most beautiful ever constructed, elegantly coiled spirals and other highly ornamental designs, of various colored glass, alternate with richly-colored fluorescent solutions. The whole is encased in a strong outside tube. When illuminated by its electric discharge, the effect is extremely beautiful . . . . .	30 00
No. 123, Geissler's Tube, 18 inches long, with bulbs for showing stratification of the electric light . . . . .	4 50
No. 123a, Geissler's Tube, same as No. 123, but larger . . . . .	7 00
No. 124, Holtz's Tube, for showing the influence of points, in the direction of currents in Geissler's Tube, according to the direction of the current—one or the other branch is luminous . . . . .	10 00
No. 125, Geissler's Tube, double U form, with fluorescent solution and Uranium glass bulbs, showing stratification . . . . .	10 00
No. 126, Phosphorescent Tubes, in the shape of letters, filled with phosphorescent powders, of various colors. Price according to size of letters, etc. Designs various.	
No. 126a, Phosphorescent Tubes, small and straight; 7 tubes, giving the various tints of the spectrum. Per set, in case . . . . .	5 00
No. 127, Geissler's Stratification Tube, according to size.	\$4.50 to 12 00

PRICE

- No. 123, U Tube, about 24 inches high, with 6 fluorescent solutions and Uranium spirals, bulbs, etc., etc. Very beautiful . . . . . 10 00
- No. 135, Crowns of Uranium Balls, about 10 inches high . . . . . 5 00
- No. 136, Geissler's Tubes, double tube, U form, with Uranium balls and spirals, with fluorescent solutions, arms 9 and 10 inches long . . . . . 10 50
- Nos. 137, 138, 139, 140, Geissler's Motto Tubes, containing various mottoes and names, etc., in Uranium glass and special forms to order. Price according to size, etc.
- No. 141, Gassiot's Star. This beautiful effect is produced by revolving a single Geissler's Tube. Price of Tube alone, with Uranium bulbs, etc., very fine, for rotating . . . . . 9 00
- See Nos. 2143, 2144, Optical Catalogue.
- No. 142, Large U Tube, with 3 fluorescent solutions and 2 rosettes, about 1 metre in extreme length. Very fine . . . . . 20 00

## CROOKES' TUBES.

---

The *remarkable discoveries* of Prof. Crookes have awakened, among scientists in this country, an intense interest, and have greatly stimulated the study of *Molecular Physics*. We have already furnished these tubes to the principal universities and colleges of the country, and in consequence of the great numbers of Crookes' Tubes we have had manufactured, we are enabled not only to reduce their price, but also greatly to improve their *quality*, both as to *performance* and *durability*, which are very important considerations with delicate glass apparatus. As now *perfected* they are of large size, and some of them are really marvelous exhibitions of the glass-blowers' skill (see Nos. 11, 17, etc., etc.) We are now able to furnish Nos. 14, 15, 17, 18—not in our first circular.

These beautiful tubes, illustrating Prof. Crookes' experiments on "Radiated Matter," are prepared with extreme care, being exhausted to about the *millionth of an atmosphere*.

Prof. Crookes says: "In studying this Fourth State of Matter we seem at length to have within our grasp and obedient to our control the little indivisible particles which with good warrant are supposed to constitute the physical basis of the universe. We have seen that in some of its properties Radiant Matter is as material as this table, whilst in other properties it almost assumes the character of Radiant Energy. We have actually touched the border land where Matter and Force seem to merge into one another, the shadowy realm between Known and Unknown which for me has already had peculiar temptations. I venture to think that the greatest scientific problems of the future will find their solution in this Border Land, and even beyond; here, it seems to me, lie Ultimate Realities, subtle, far-reaching, wonderful."

"Yet all these were, when no man did them know,  
 Yet have from wisest Ages hidden beene;  
 And later Times things more unknowne shall show.  
 Why then should witlesse Man so much misweene,  
 That nothing is, but that which he hath seene?"



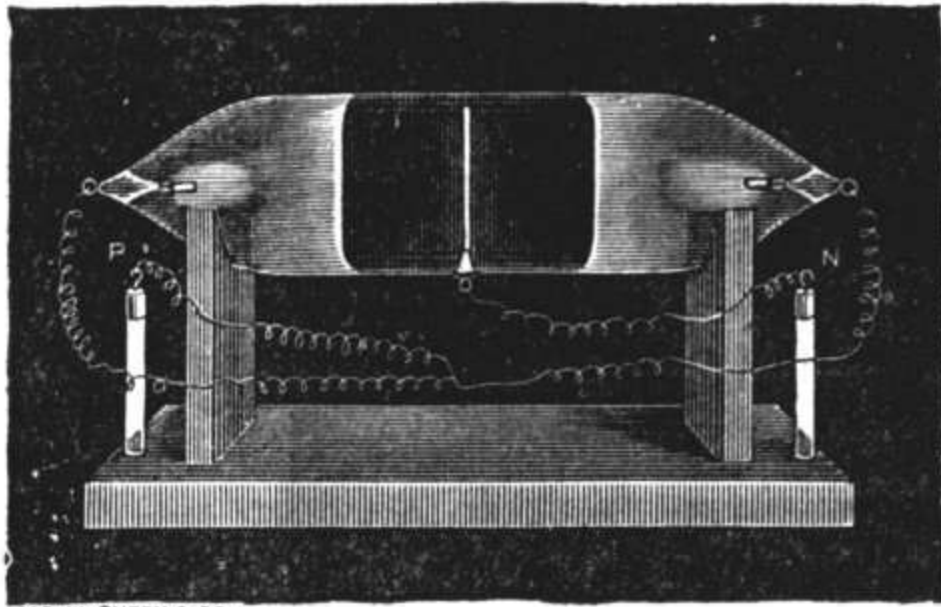

JAS. W. QUEEN & CO.

No. 1.

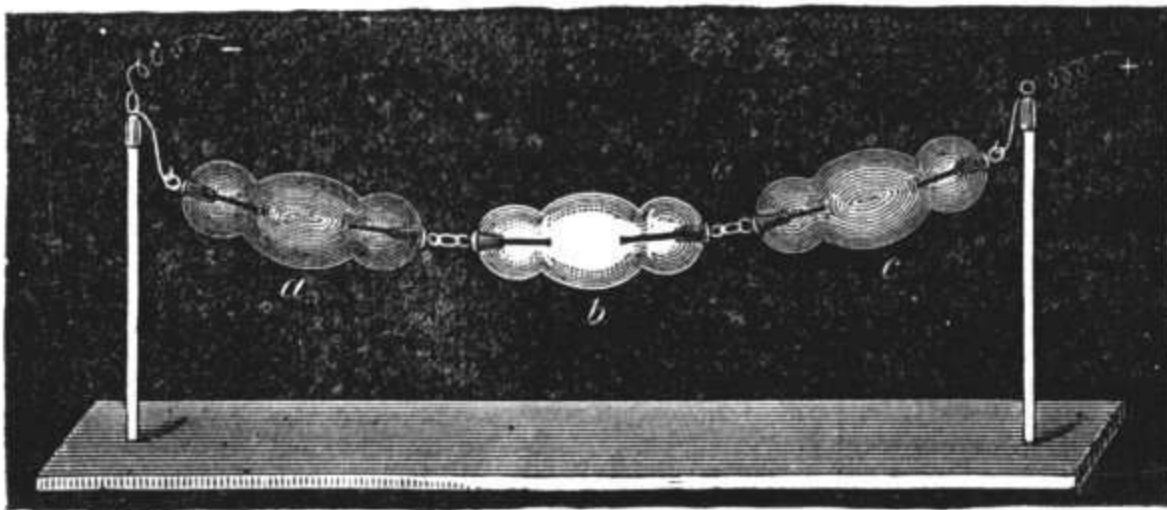

No. 2.

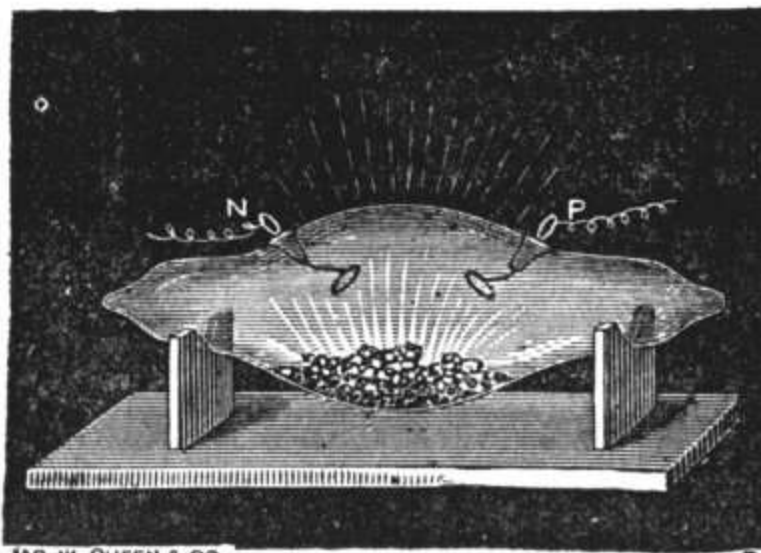

JAS. W. QUEEN & CO.

No. 4.

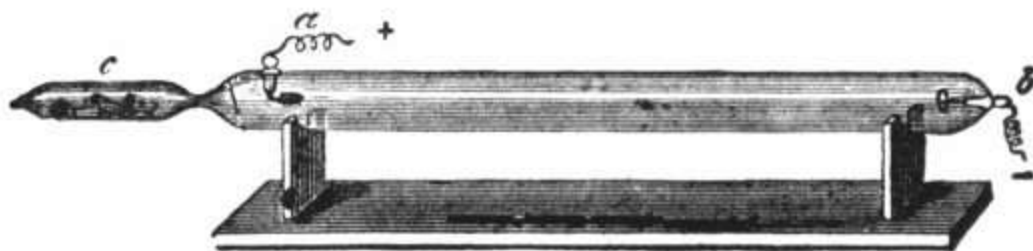

No. 5.

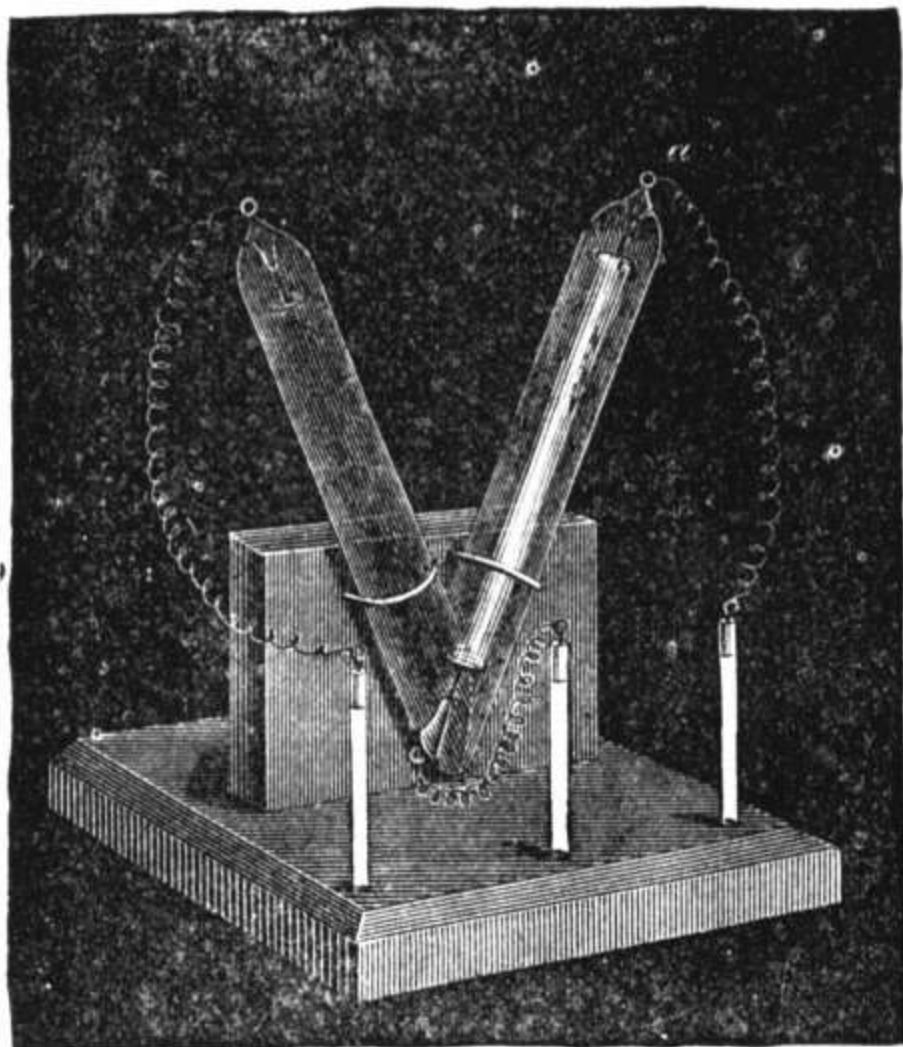

No. 6.

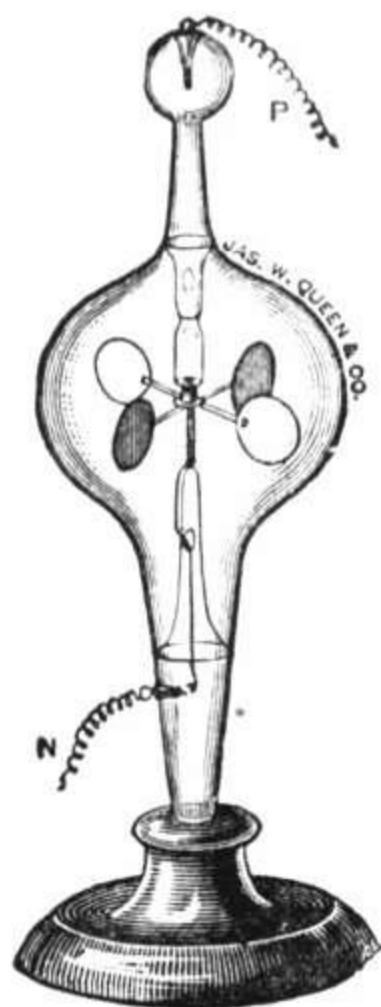

No. 12.

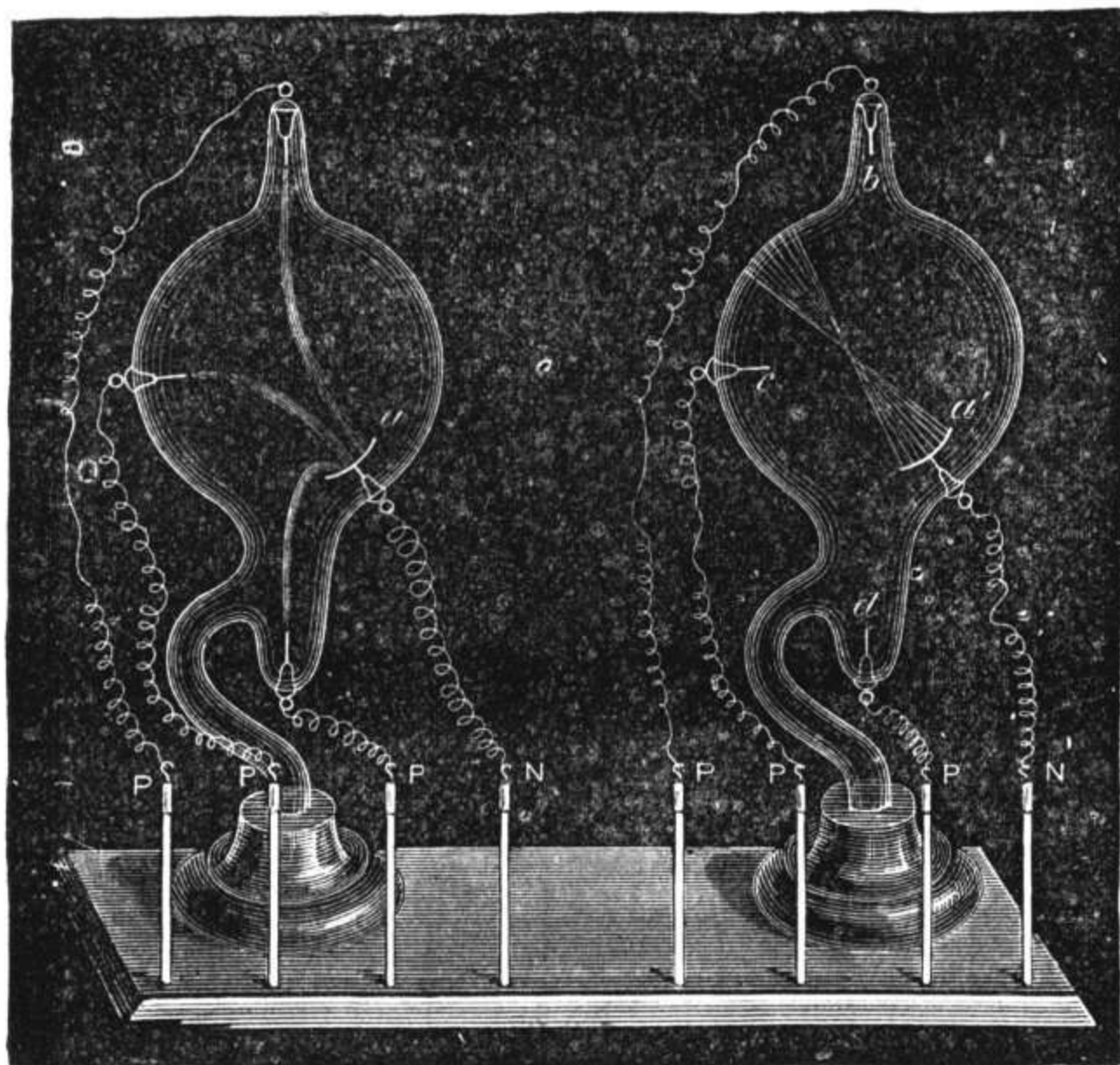

JAS. W. QUEEN & CO.

No. 7.

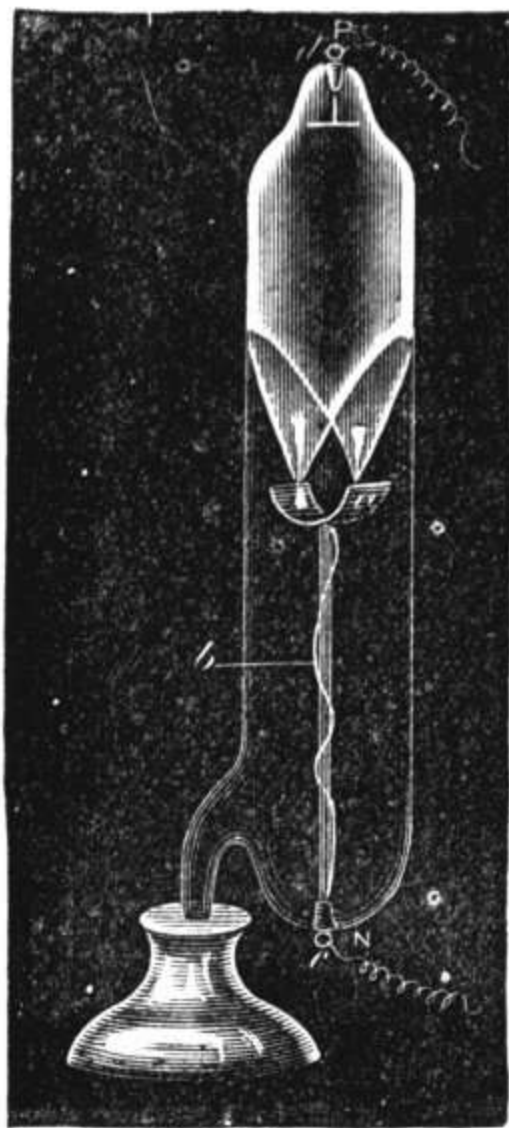

No. 8.



JAS. W. QUEEN & CO.  
No. 21.

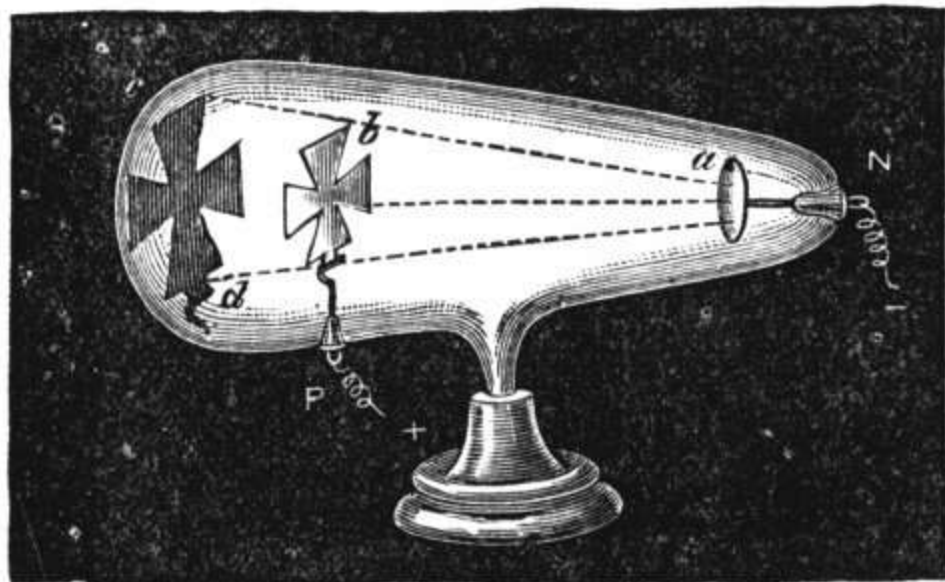

No. 9.

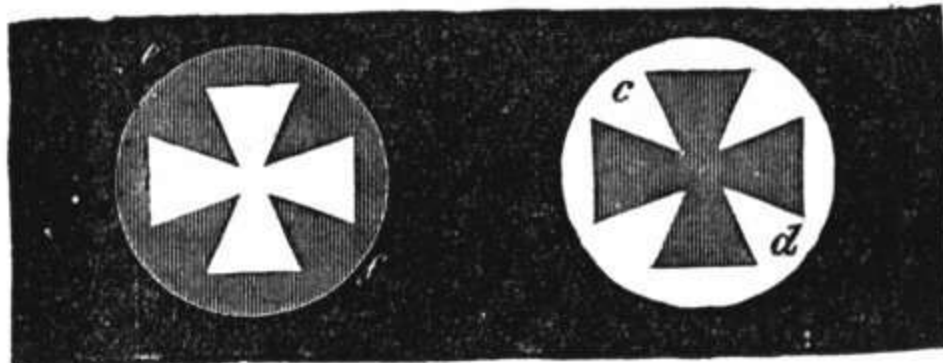

No. 10.

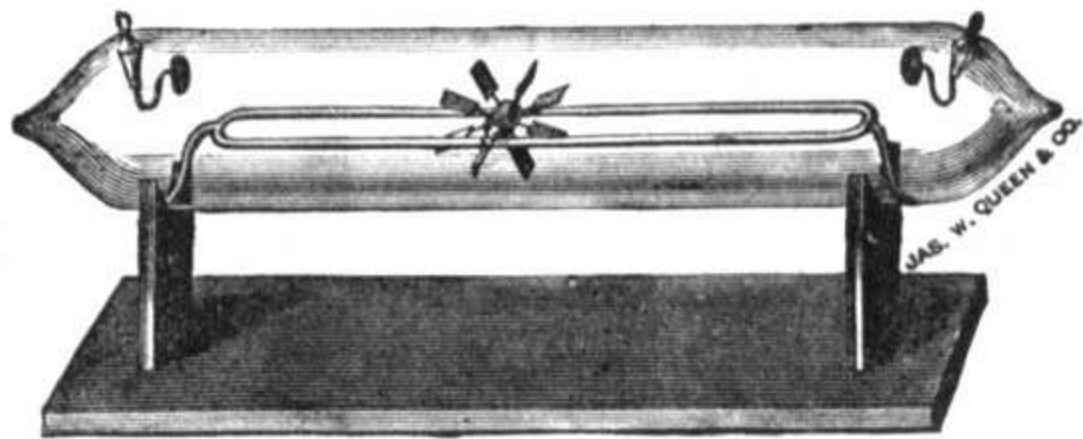

No. 11.

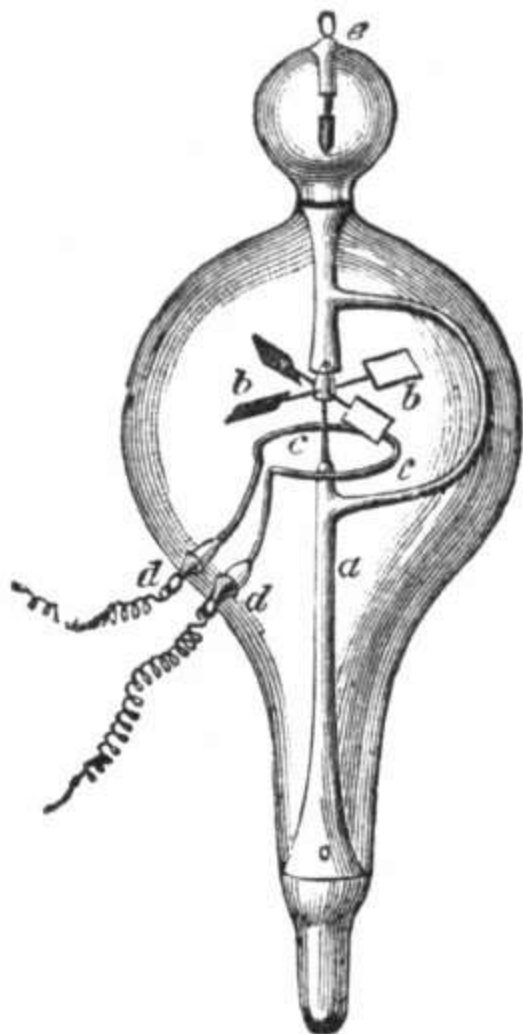

No. 13.

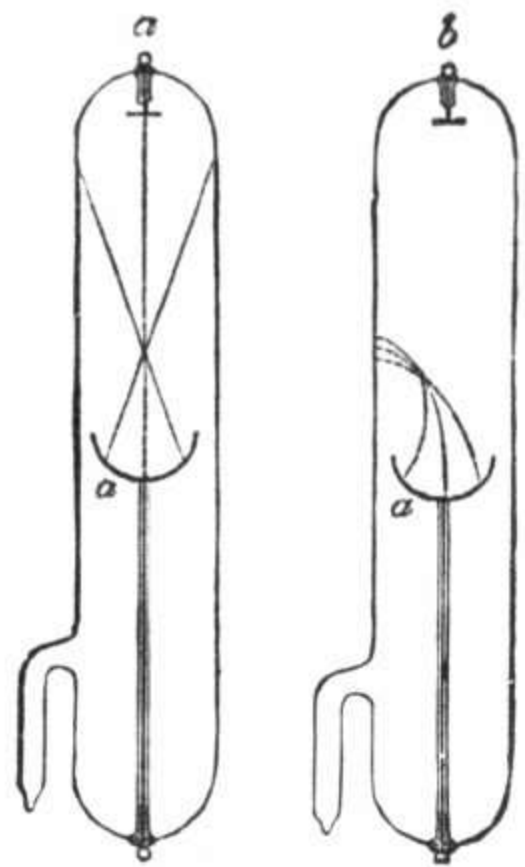

No. 19.

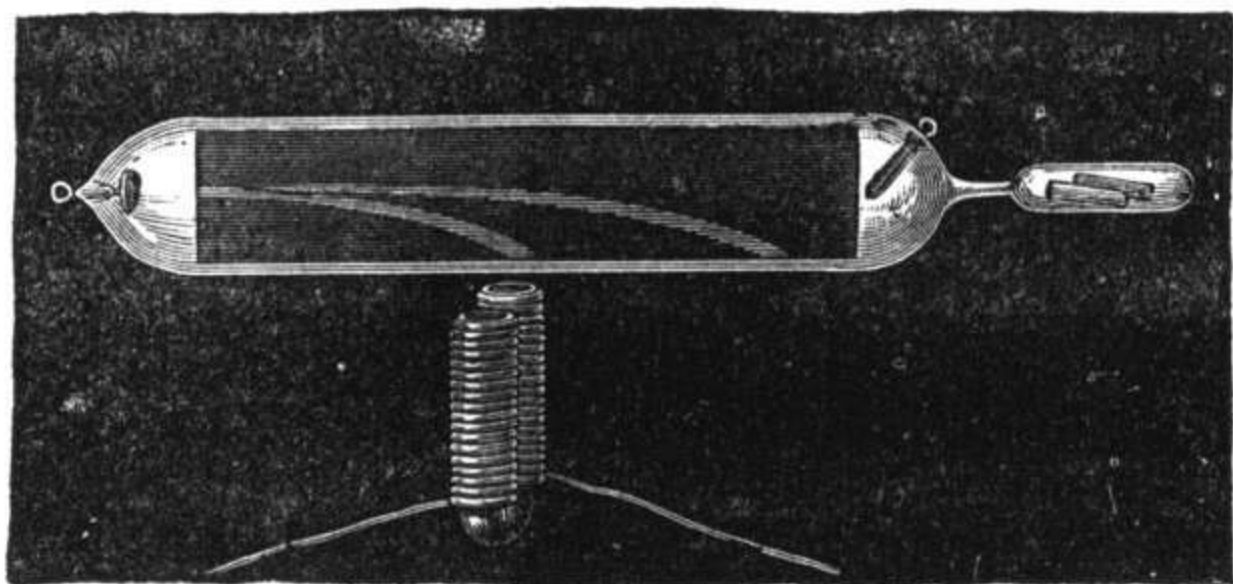

No. 15.

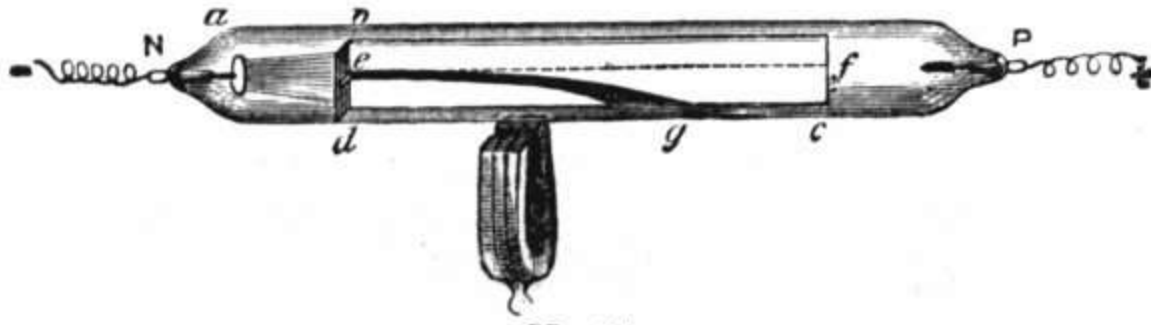

No. 14.

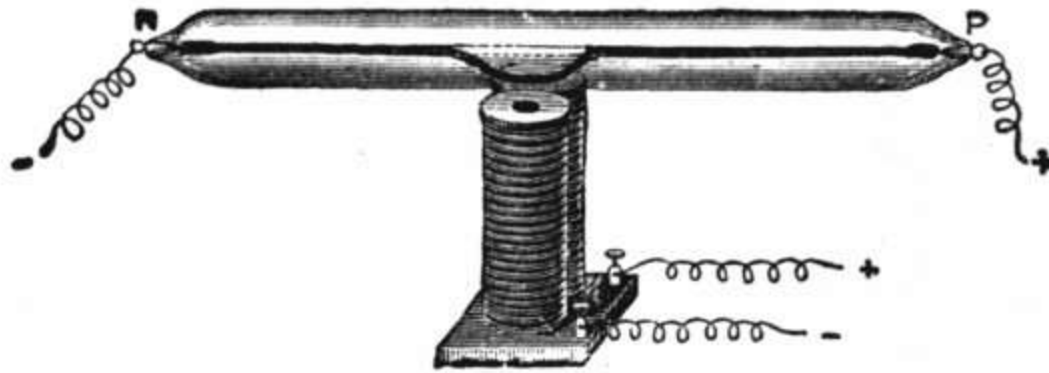

No. 16.

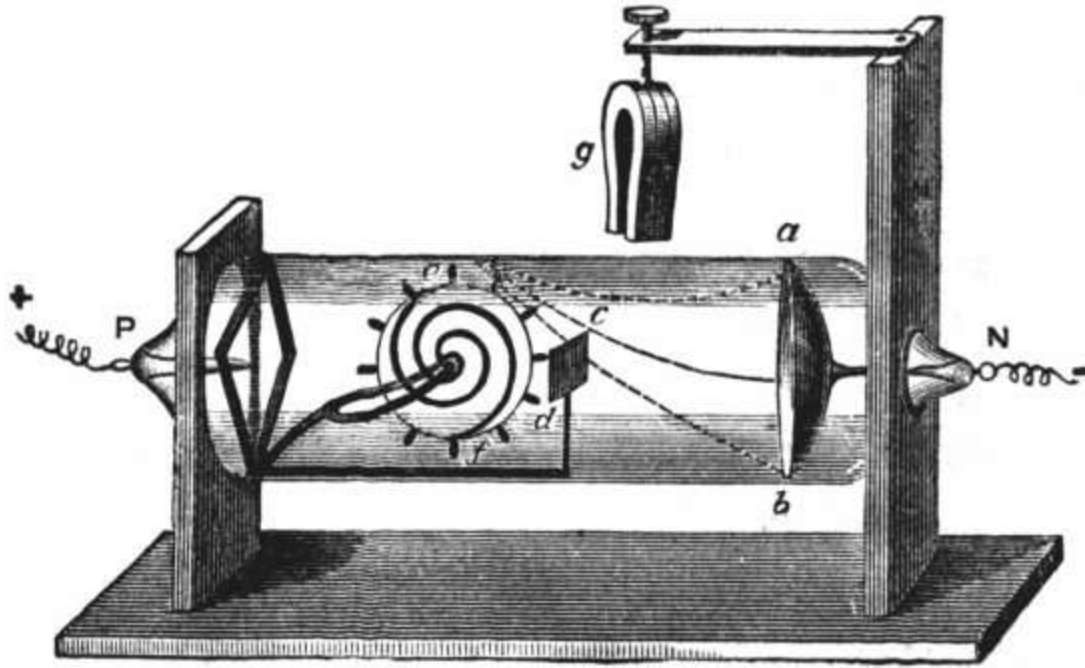

No. 17.

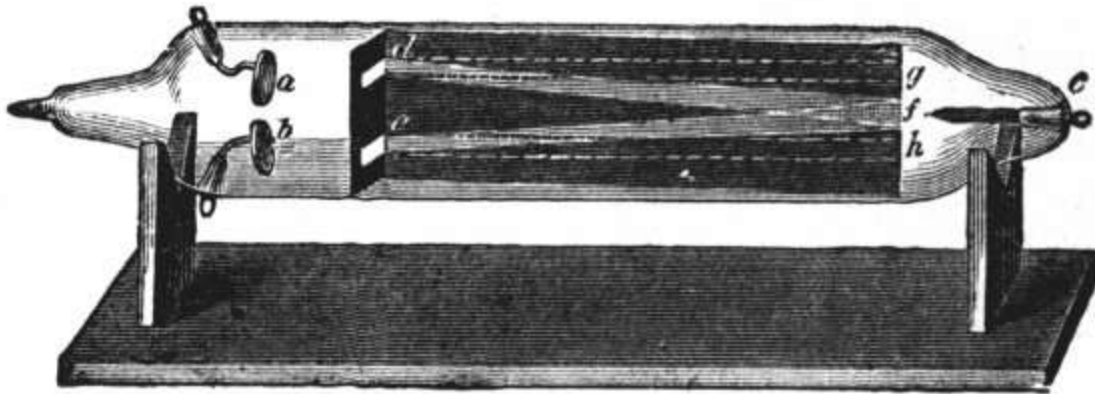

No. 18.

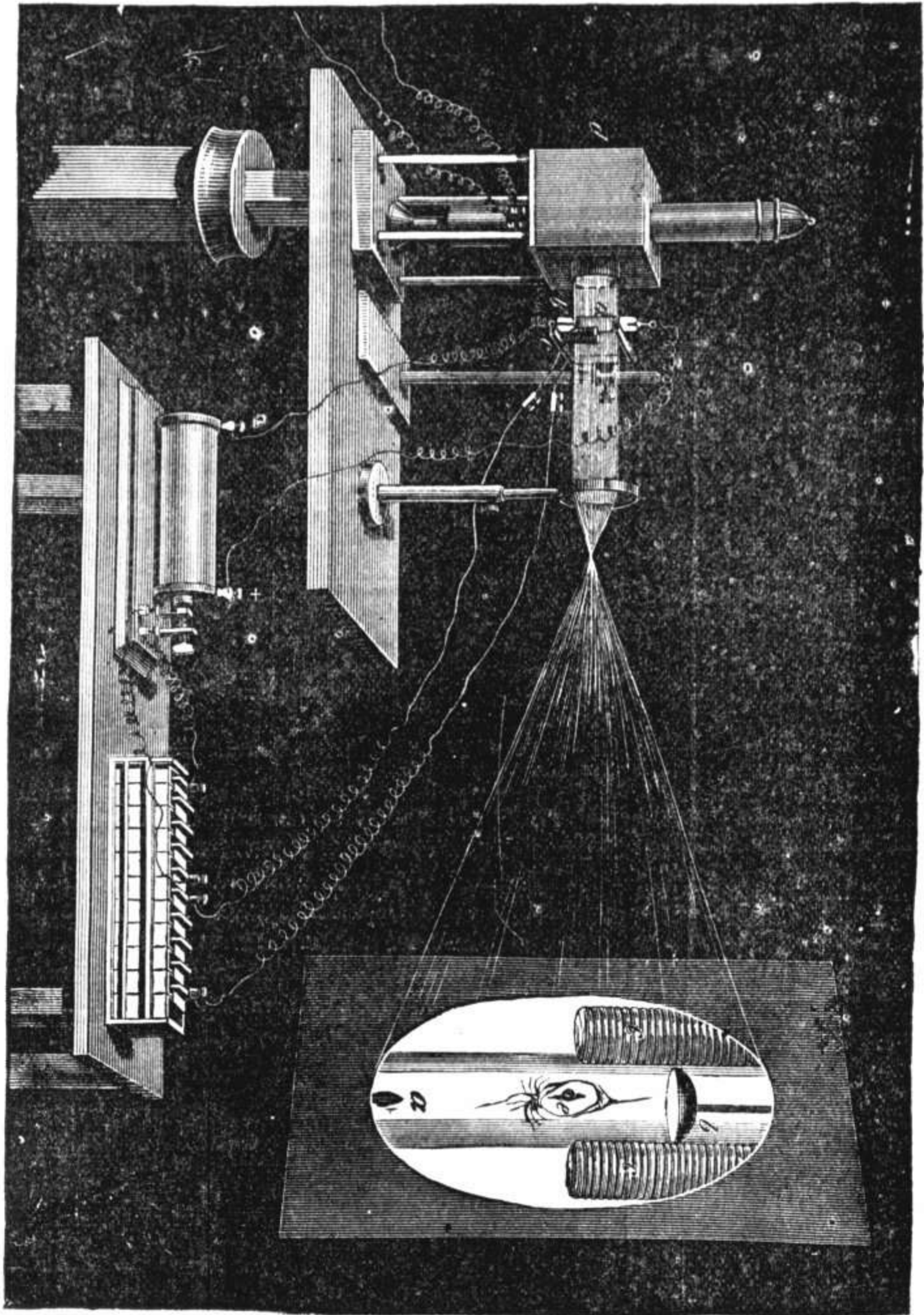

No. 211

# CROOKES' RADIANT MATTER TUBES

We would call especial attention to the fact that all our Crookes' Tubes are of extra large size, very perfectly formed, and are throughout thoroughly exhausted and of choice workmanship. See recommendations of eminent physicists. While we do not keep them in stock, and do not recommend them, we can furnish smaller and less perfectly formed tubes.

	PRICE
No. 1. "Dark Space Tube," illustrating the mean free path of the Molecules,	\$6 00
No. 2. "Three Phosphorescent Tubes," a, b, c, showing the power of Radiant Matter to cause phosphorescence, varying in color, according to the glass of which the tube is made. Three pieces complete, . . . . .	6 00
No. 4. "Ruby Tube." "As soon as the induction spark is turned on you will see these rubies showing with brilliant rich red tone, as if they were glowing hot," . . . . .	7 00

We can furnish some 12 or 15 varieties of No. 4. They are very beautiful, and many Professors desire several kinds of this Tube filled with different substances.

No. 5. "Potash Tube." Illustrating the dependence of the phosphorescence of the glass on the degree of exhaustion, . . . . .	8 50
No. 6. "V Shaped Tube," showing that Radiant Matter will not turn a corner,	6 00
No. 7. "Two tubes for showing independence of positive pole;" one of the tubes is exhausted to about the millionth of an atmosphere, . . . . .	12 00
No. 8. "Hemi-Cylinder Tube," showing that Radiant Matter is discharged normal to the surface of the negative pole. Very beautiful, . . . . .	5 00
No. 9. "Stencil Tube," showing that Radiant Matter alters in some way the surface of the glass where it strikes. This can only be used for the actual experiment once or twice, but always remains a perfect shadow tube, . . . . .	12 00
No. 11. "Railway Tube," showing the strong mechanical action of Radiant Matter, . . . . .	15 00
No. 12. "Electric Radiometer." The above experiment reversed or showing the recoil of the negative pole from the molecules, . . . . .	6 00
No. 13. Tube illustrating the mechanical force of Radiant Matter; can be used for projection, . . . . .	6 00
No. 14. "Ray of Light High Vacuum Tube," showing the permanent deflection of Radiant Matter by a magnet, . . . . .	8 00
No. 15. "Ray of Light High Vacuum Tube," with a phosphorescent screen, on which the Radiant Matter traces its trajectory, with potash bulb, to show that the curve of the trajectory depends on the degree of exhaustion, . . . . .	10 50
16. "Ray of Light, Low Vacuum Tube," showing that the current in a Geissler tube is only temporarily deflected by a magnet, . . . . .	3 00
No. 17. "Mill-Wheel Tube," for beautifully illustrating the deflection by a magnet in the Lantern. With this we are able to make an over-shot water-wheel and under-shot. Very fine, . . . . .	15 00
No. 18. "Crookes' Tube," with phosphorescent screen, for showing that two parallel streams of Radiant Matter exert mutual repulsion, . . . . .	10 00
No. 19. "Tubes for Cracking in Lantern," showing the great heat produced by bringing Radiant Matter to a focus, . . . . .	5 00

This experiment can be effectively shown by simply melting some wax with which the outside may be coated without injuring the tube.

No. 21. "Hot Platinum Tube," illustrating the preceding experiment permanently, . . . . .	9 00
---	------

Stands for above will be furnished and charged when not otherwise specified.

We have a large stock of these tubes, and can furnish at once.

The Crookes' Tubes are priced without stands. Below will be found a list of the stands, which are neatly turned and polished, and, where necessary, fitted with connections insulated on rubber posts. They are quite necessary for the proper preservation and convenient exhibition of the tubes

Stand for Crookes' Tube, No.	PRICE	Stand for Crookes' Tube, No.	PRICE
1,	\$1 00	12,	\$0 30
" 2,	1 00	" 13,	30
" 4,	40	" 14,	50
" 5,	50	" 15,	50
" 6,	1 00	" 16,	40
" 7,	2 00	" 17,	1 50
" 8,	30	" 18,	50
" 9,	30	" 19,	30
" 11,	50	" 21,	30

COMPOUND PERMANENT MAGNET, very large, made of the best steel, capable of sustaining about 28 pounds; the poles are widely separated, and these magnets are especially adapted for experiments with Crookes' Tubes. The Shadow Tube, No. 9, and, in fact, all other tubes, show beautiful phenomena under the influence of a strong magnet..... 12 00

A Ruhmkorff Induction Coil will be necessary for the proper illumination of these Tubes. See Philosophical and Chemical Catalogue, page 103.

"ABSOLUTE VACUUM TUBE," in which the vacuum is so perfect that the current will not pass between the wires, although they are but one-eighth of an inch apart..... 7 00

NEW CROOKES' TUBES, containing minerals, giving many rich and beautiful colors when subjected to the influence of radiant matter.



No. 26.

26. NEW CROOKES' TUBES, containing a rhomb of Iceland spar, giving a brilliant yellow light, and a beautiful phosphorescence, lasting for perhaps one minute or more..... 10 00



- |   |         |
|---|---------|
| 27. NEW CROOKES' TUBES, containing Smithsonite, phosphorescing with brilliant green light.....  | \$10 00 |
| 28. NEW CROOKES' TUBES, containing strontianite.....  | 10 00   |
| 29. NEW CROOKES' TUBES, containing lepidolite. Gives varied and brilliant colors.....           | 10 00   |
| 30. NEW CROOKES' TUBES, containing marble.....  | 10 00   |
| 31. NEW CROOKES' TUBES, containing coral.....   | 10 00   |
| 32. NEW CROOKES' TUBES, containing diamonds very brilliant, according to the price of diamonds. |         |

ADDITIONAL CROOKES' TUBES.

PHOSPHORESCENT DIAMONDS,

OF A

Brilliant Light Blue Color,

Bright Blue,

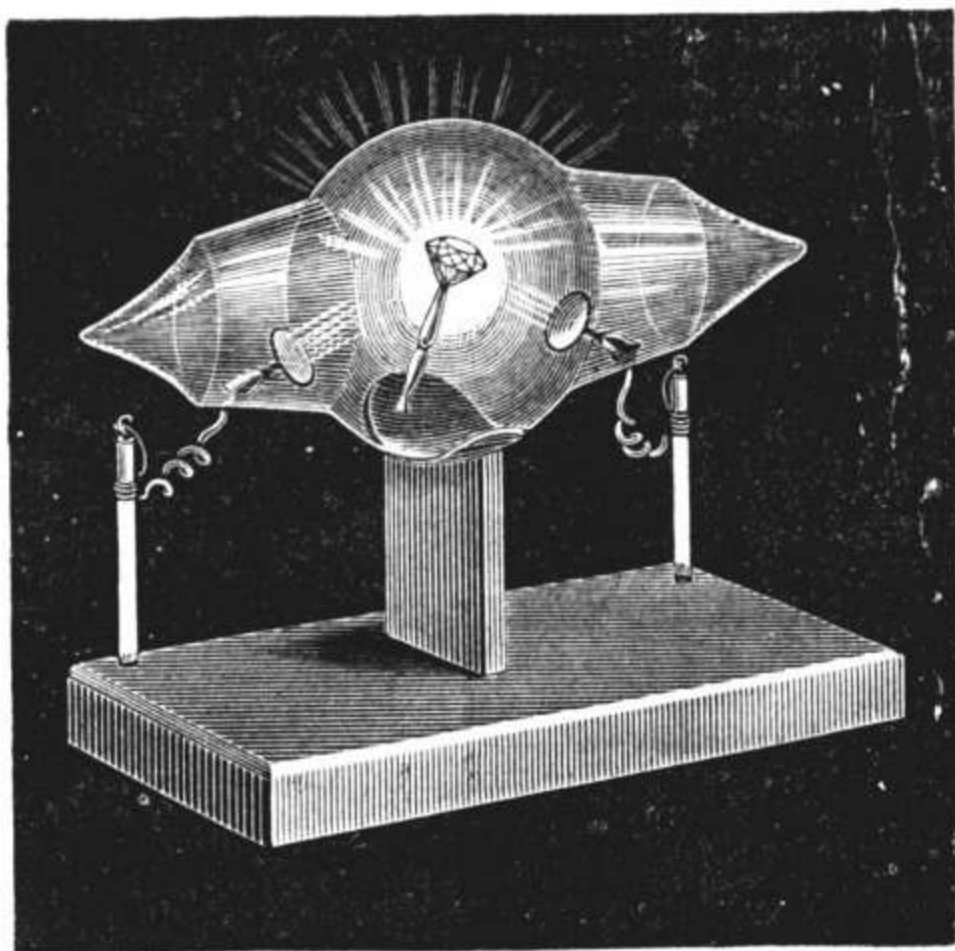

Pale Blue, Apricot,

Red, Yellowish Green,

Orange,

Bright Green,

Very brilliant and beautiful, giving almost as much light as a Candle.

No. 3. DIAMOND TUBE.

No. 3. DIAMOND TUBE. Diamonds when subjected to the molecular bombardment, phosphoresce with great brilliancy, the stones assuming rich and various colors under the influence of Radiant Matter. Price, according to size and quality, on application.

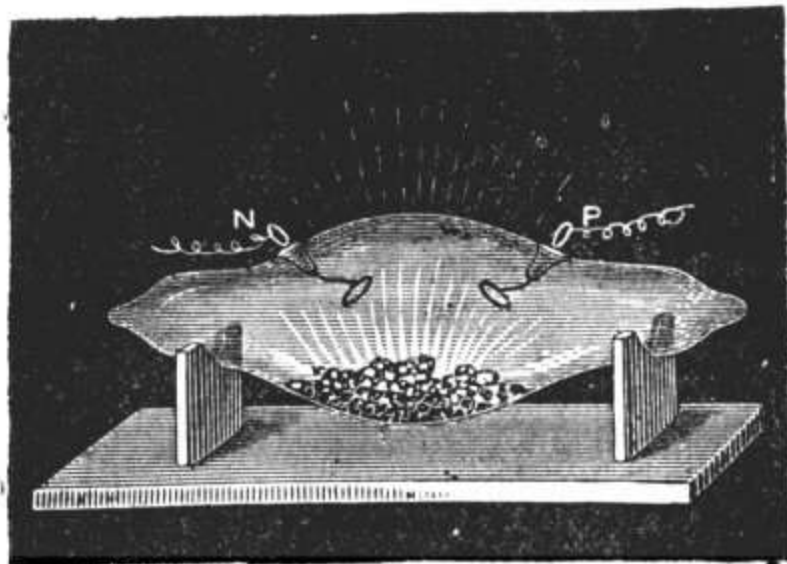

JAS. W. QUEEN & CO.

No. 4. RUBY TUBE.

Prof. Crookes, in a recent article entitled "Discontinuous Phosphorescent Spectra in High Vacua," read before the Royal Society, gives a very elaborate list of substances he has examined, with remarkable results, he says: "During the analysis of some minerals containing the rarer earths experimented on, certain anomalies have been met with, which seem to indicate the possible presence of other unknown elements awaiting detection.

It has been my practice to submit these anomalous bodies to *molecular bombardment*, and I have had the satisfaction of discovering a class of earthy bodies, which, whilst they phosphoresce strongly, also give spectra of remarkable beauty. For the convenience of those physicists who desire to study this interesting subject, we have prepared a list of those substances which phosphoresce most brilliantly.

No. 4. RUBY TUBE. Containing natural Ruby Corundum, or Artificial Ruby. These glow with an exceedingly beautiful rich red color. The phosphorescent light emitted is seen to be discontinuous, when examined with a spectroscope.

No. 4. RUBY TUBE. Containing Calcium Carbonate (Calcite); phosphoresces of a bright straw color. Calcite shows the residual glow longer than any substance yet experimented with. After the current has been turned off, the crystals shine in the dark, with a yellow light, for more than a minute.

No. 4. RUBY TUBE. Containing Calcite, calcined; phosphoresces purple and gold; very bright.

No. 4. RUBY TUBE. Containing Pectolite; phosphoresces brightly; yellow needles.

No. 4. RUBY TUBE. Containing Lepidolite; phosphoresces dark red.

No. 4. RUBY TUBE. Containing Arragonite; phosphoresces purple and golden yellow; very beautiful and bright.

No. 4. RUBY TUBE. Containing Strontianite; phosphoresces beautiful blue; very bright.

No. 4. RUBY TUBE. Containing small rhombs of Iceland Spar; phosphoresces reddish yellow, and continues to glow some time.

No. 4. RUBY TUBE. Containing Iceland Spar, calcined; phosphoresces golden yellow; very bright and beautiful.

No. 4. RUBY TUBE. Containing Smithsonite; phosphoresces beautiful deep green; very bright.

No. 4. RUBY TUBE. Containing mussel shells, calcined; phosphoresces with brilliant iridescent colors.

No. 4. RUBY TUBE. Containing Phenakite; phosphoresces blue, and shows residual glow.

We can make to order Crookes' Tubes, containing the principal phosphorescent substances mentioned below:

Alumina, sapphire, spinel, spodumine, glucina, zirconia, erbia, magnesia, baryta (hydrated), strontia (hydrated), lime, calcium phosphate, potash, soda, lithium carbonate, emerald, tinstone.

CROOKES' TUBE. With corrugated negative pole, screen with aperture, etc., for illustrating molecular projections, etc., after suggestions of Prof. Maxwell. See *Nature*, Vol. xxii, No. 6, page 101, figs. 1 to 6.

CROOKES' TUBE. With two ordinary terminals, and two extra large aluminum disks, connected with outer terminals, for connection with gold leaf electroscope, etc. Figs. 7 and 8.

CROOKES' TUBE. With suspended fluorescent screen, pendulum, fixed aluminum bar, etc. Figs. 9 and 10.

CROOKES' TUBE. Indicator, with two negative poles, mica screen, with aperture, and phosphorescent screen. *Nature*, Vol. xxii, No. 6, fig. 12.

CROOKES' TUBE. For obtaining "continuous rotation of the molecular rays under magnetic influence," either "high vacuum" or "low vacuum." Figs. 13 and 14.

Prices on application.

**CROOKES' RADIOMETERS.**

**PAMPHLET ON CROOKES' RADIOMETERS**, containing a description of the construction, action, and use of the radiometer, discovered by William Crookes, F. R. S., V. P. C. S., and first exhibited by him at the Soiree of the Royal Society ..... 50

**40. CROOKES' RADIOMETER**, of best construction, improved form, large size, ..... 7 50

**41. CROOKES' RADIOMETER**, medium size, very delicate, and mounted on a neat stand..... 4 50

**43. CROOKES' NEW RADIOMETER**, with mica and metal vanes, revolving by radiation..... 5 00

**44. CROOKES' NEW RADIOMETER**, with metal vanes, white or gilt, very sensitive..... 5 00

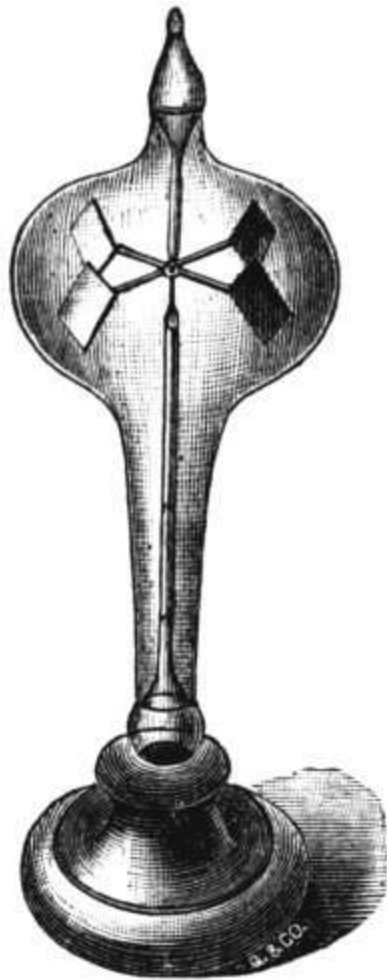

40 and 41.

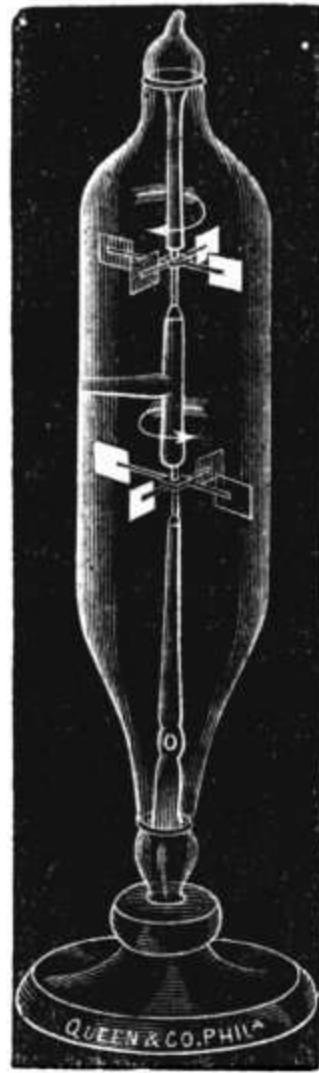

45.

**45. CROOKES' NEW DOUBLE RADIOMETER**, with two sets of vanes, blackened on opposite sides, producing the remarkable effect of two sets of vanes, revolving in contrary directions in the same tube. Very good..... 7 50

**46. CROOKES' NEW RADIOMETER**, with absolute vacuum tube attached..... 10 50

**47. CROOKES' NEW RADIOMETER**, with permanent metal vanes, over which is an unblackened mica disk, which revolves..... 7 00

**48. CROOKES' NEW RADIOMETER**, same as above, but with movable blackened mica vanes, placed at an angle, over which is a revolving unblackened mica disk..... 8 00

## NEW ELECTRICAL RADIOMETERS,

*Showing Phenomena scarcely less interesting than the Original Tubes.*

<b>Electrical Radiometer</b> , with Phosphorescent Vanes. (Fig. 50.) During the passage of the current, the molecular rays passing from the negative pole downward produce a vivid phosphorescence on the vanes and cause a rapid rotary motion.....	\$12 00
<b>Electric Radiometer</b> , with Phosphorescent Disc. (Fig. 51.) This radiometer shows a very remarkable motion if the lower electrode is employed as the negative pole.....	12 00
<b>Electric Radiometer</b> , with Double Phosphorescent Discs. (Fig. 52.) Showing the effect of reversion of current on revolving discs.....	16 00
<b>Electrical Radiometer</b> , with Rotating Bell-glass. (Fig. 53.) Showing the rotation of the bell-glass from the mica side of one vane toward the aluminium side of the second.....	16 50
<b>Phosphorescent Lamp</b> . Showing various interesting experiments.....	13 50
<b>Apparatus</b> to demonstrate that the electric discharges in Vacuo are influenced by the static electricity of the walls. (Fig. 55.).....	7 50

Fig 50.

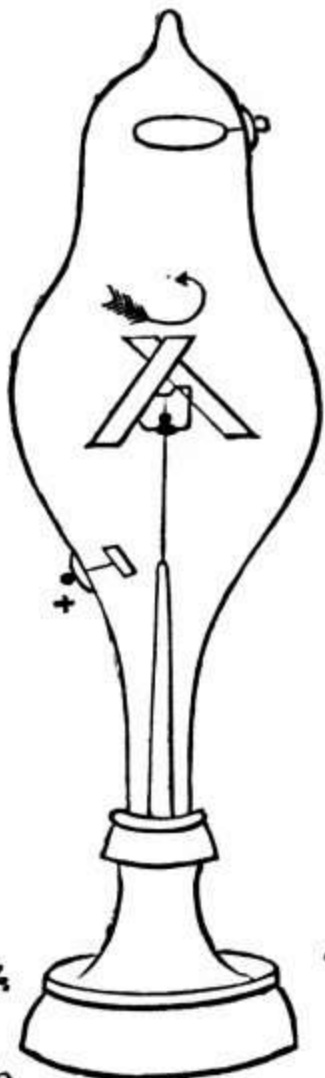

Fig 51.

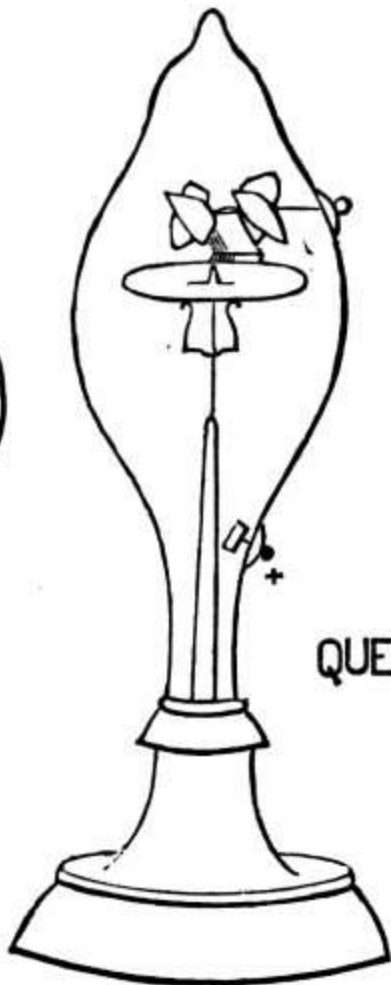
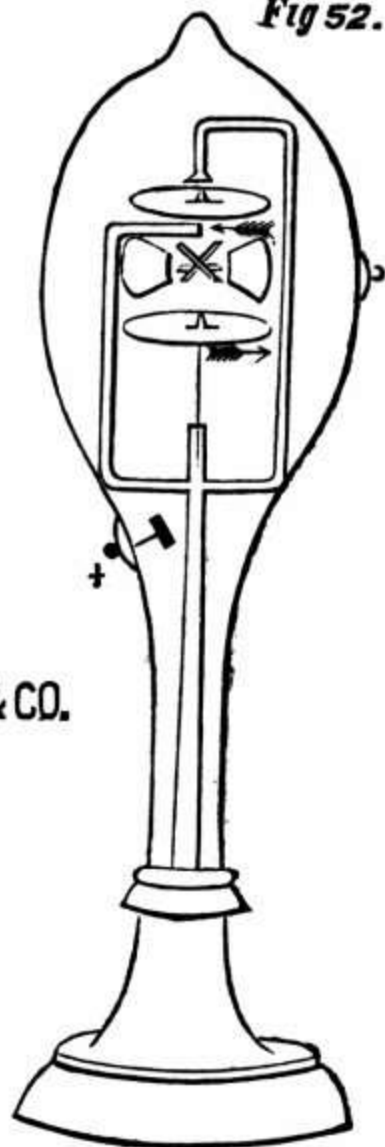

Fig 52.



QUEEN & CO.

Fig 54.

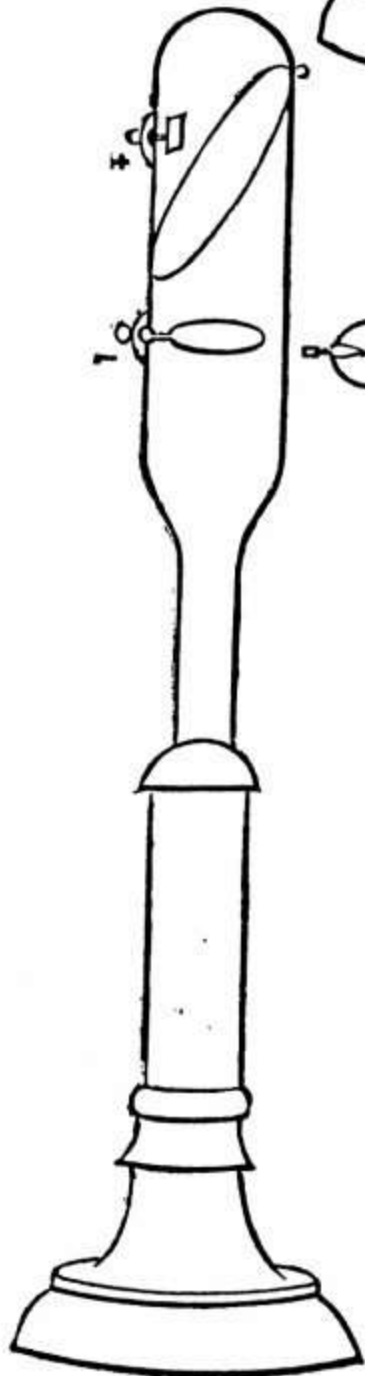

Fig 55.

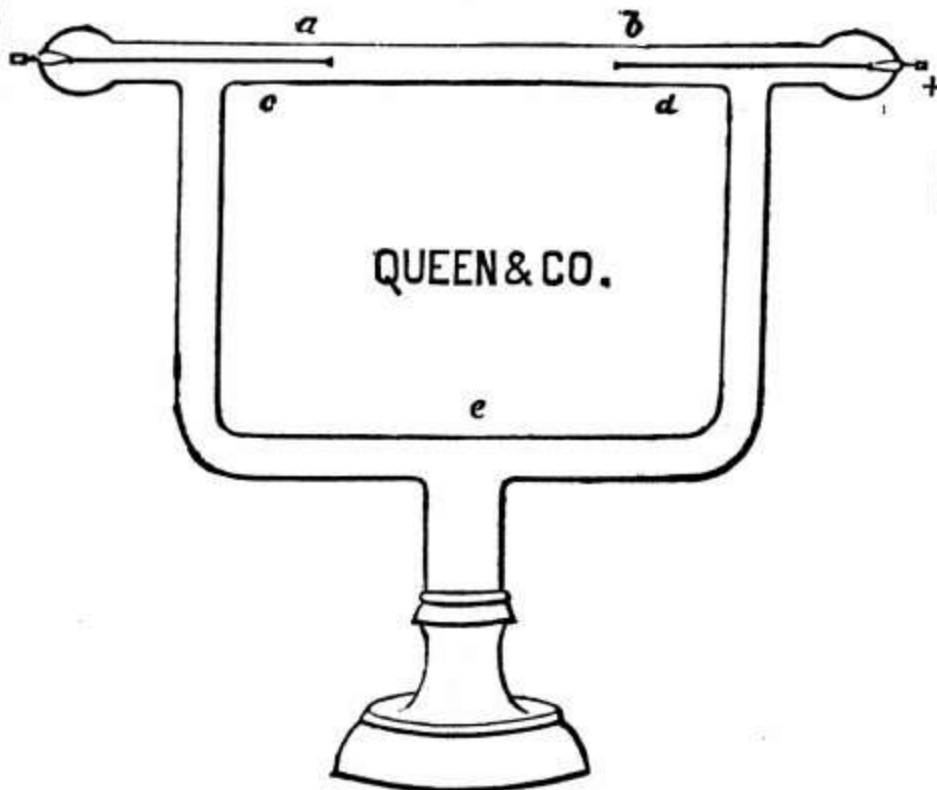
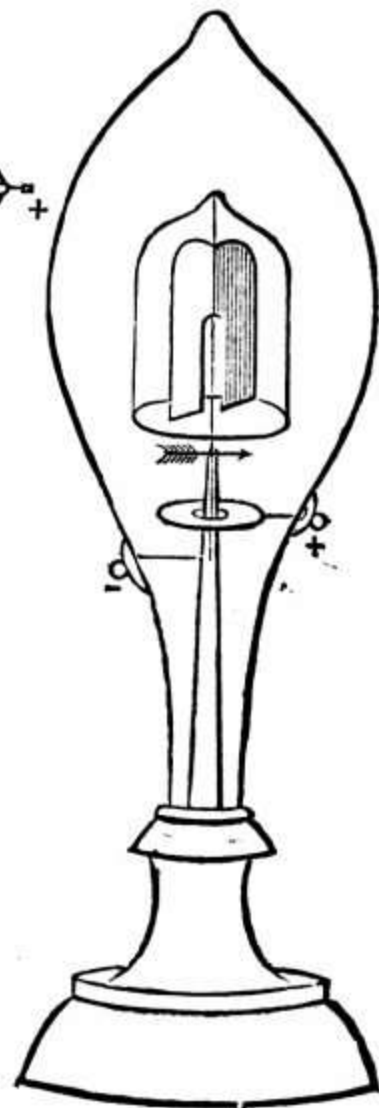

Fig 53.



**FOURTH STATE OF MATTER.**  
**LECTURE ON "RADIANT MATTER,"**

Delivered to the "British Association for the Advancement of Science," at Sheffield,  
August 22d, 1879,

By WILLIAM CROOKES, F. R. S.

Beautifully Illustrated.

We have published this in separate form, neat and convenient for reference.

*Price, 50 cents, by mail.*

**TESTIMONIALS OF CROOKES' TUBES.**

Several eminent scientists have purchased sets of our Crookes' Tubes, and find them to compare very favorably with those employed by Prof. Crookes. We have recently improved their size, shape and durability, and at the same time reduced their price. Prof. Geo. F. Barker, who has probably examined more Crookes' Tubes than any other physicist in America, after referring to our new Toepler Holtz machine, for description of which see page 8, speaks as follows:

"UNIVERSITY OF PENNSYLVANIA.

"PHILADELPHIA, Feb. 18th, 1881.

"MESSRS. JAMES W. QUEEN & Co.

"Gentlemen:—\* \* \* I take pleasure also in speaking unqualifiedly in praise of the set of Crookes' Tubes which you furnished the Physical Department. They are elegantly made, thoroughly exhausted and work most admirably. My friend, Prof. Draper, of New York, equally values the set you sent him, as you will see from the following note to me:

"271 MADISON AVENUE,  
"NEW YORK, Feb. 3d, 1881.

"MY DEAR PROF. BARKER:

"I have tried the Crookes' Tubes imported for me by Queen & Co., and find they compare very favorably with those I saw at Mr. Crookes' house in London.

"Yours truly, HENRY DRAPER."

"Wishing you all success in your endeavors to furnish high-grade apparatus at a reasonable price I am,

"Very truly yours,  
"GEORGE F. BARKER,  
"Professor of Physics."

"NORTH-WESTERN UNIVERSITY,  
"EVANSTON, ILL., Feb. 5th, 1881.

"JAMES W. QUEEN & Co., Philadelphia.

"Dear Sirs:—The set of Crookes' Tubes, which you imported for me, came in excellent order and give satisfaction. I have had the pleasure of exhibiting them before the Chicago Electrical Society, and several scientific gentlemen and electricians present expressed great gratification at the very perfect manner in which they demonstrate the new properties of residual gases in very high vacua. The reasonable price at which you furnish them puts them within the reach of all institutions interested in the latest scientific discoveries. Yours truly,

"H. S. CARHART,  
"Prof. of Physics and Chemistry."

"MASS. INST. TECHNOLOGY, BOSTON, Feb. 16th, 1881.

"MESSRS. JAMES W. QUEEN & Co.,

"Gentlemen:—The Crookes' Tubes furnished by you have proved exceedingly satisfactory, are of good size, and capable of exhibiting the various phenomena which they are intended to show with quite a small induction coil.

"I am yours very truly,  
"CHAS. R. CROSS."

# ELECTRICAL INSTRUMENTS FOR PRACTICAL PURPOSES.

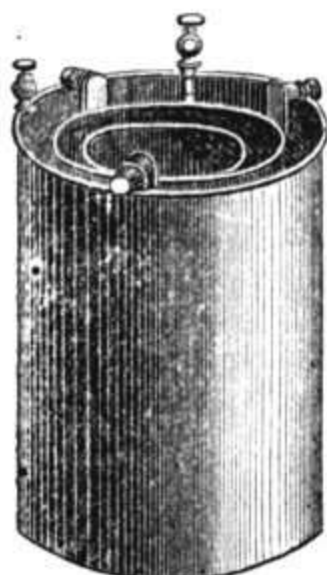

6000.

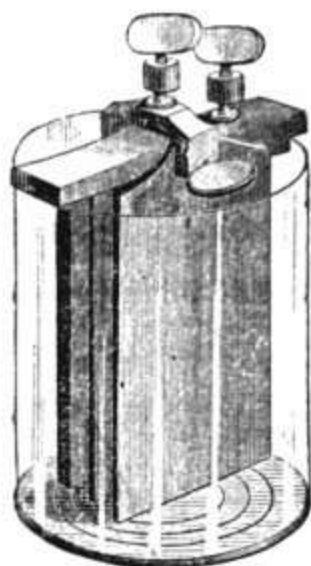

6001.

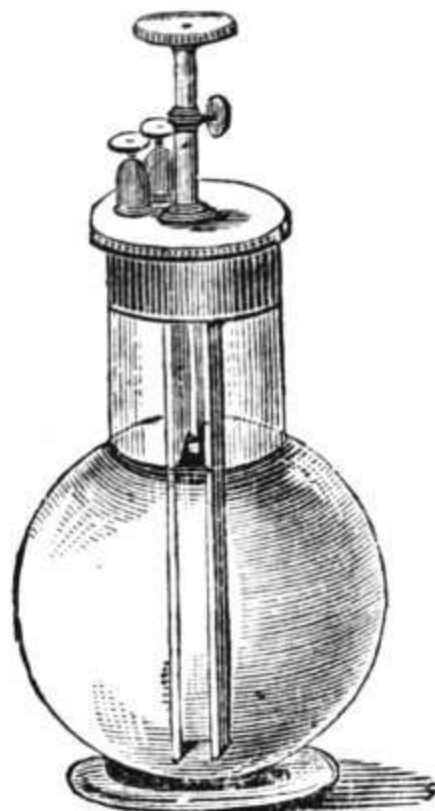

6004.

6000. **Sulphate of Copper Battery.** Double cell of copper, supporting cell of zinc by means of wooden insulators. Cell 9 inches high, \$5 00

6001. **Smee Battery, with Carbon Plates,**

	No. 1. 3x5.	No. 2 4½x7½.	No. 3. 4x8.	No. 4. 6x10.
Cell complete, . . . . .	\$2 50	\$2 75	\$3 50	\$5 00
Glass jar only, . . . . .	30	30	37	35
Zincs, per pair, . . . . .	50	60	95	1 60
Carbon and connector, . . . . .	75	90	1 20	1 75
" connector, . . . . .	18	18	18	18
" insulator, . . . . .	9	9	10	10
Clamp, . . . . .	60	60	60	60
Wood support, . . . . .	8	8	10	10

6002. **Smee Battery, with Platinized Silver Plates,**

	No. 1. 3x5.	No. 2. 3½x7½.	No. 3. 4x8.	Kidder. 2½x4½.
Size of zinc plates, . . . . .	3x5.	3½x7½.	4x8.	2½x4½.
Cell complete, . . . . .	\$3 00	\$3 75	\$5 25	\$2 50
Jar (glass), . . . . .	30	30	37	45
Platinized silver plate, . . . . .	1 50	2 00	3 00	*1 50
Connector, . . . . .	18	18	18	—
Zincs, per pair (rolled), . . . . .	50	60	95	40
Zinc clamp, . . . . .	60	60	60	40
Wood support, . . . . .	8	8	10	—

6003. **Smee Carbons, with Connections for Electrotyping Baths.**

	9x10.	10x12.	Laced connections, . . . . .	10x12.	12x12
Plain connections, . . . . .	\$3 25	\$3 75		\$5 50	\$6 60

Platinums and platinized silver plates for battery purposes made to order at short notice.

\* With connector.

**FOURTH STATE OF MATTER.**  
**LECTURE ON "RADIANT MATTER,"**

Delivered to the "British Association for the Advancement of Science," at Sheffield,  
August 22d, 1879,

By WILLIAM CROOKES, F. R. S.

Beautifully Illustrated.

We have published this in separate form, neat and convenient for reference.

*Price, 50 cents, by mail.*

**TESTIMONIALS OF CROOKES' TUBES.**

Several eminent scientists have purchased sets of our Crookes' Tubes, and find them to compare very favorably with those employed by Prof. Crookes. We have recently improved their size, shape and durability, and at the same time reduced their price. Prof. Geo. F. Barker, who has probably examined more Crookes' Tubes than any other physicist in America, after referring to our new Toepler Holtz machine, for description of which see page 8, speaks as follows:

"UNIVERSITY OF PENNSYLVANIA.

"PHILADELPHIA, Feb. 18th, 1881.

"MESSRS. JAMES W. QUEEN & Co.

"Gentlemen:—\* \* \* I take pleasure also in speaking unqualifiedly in praise of the set of Crookes' Tubes which you furnished the Physical Department. They are elegantly made, thoroughly exhausted and work most admirably. My friend, Prof. Draper, of New York, equally values the set you sent him, as you will see from the following note to me:

"271 MADISON AVENUE,

"NEW YORK, Feb. 3d, 1881.

"MY DEAR PROF. BARKER:

"I have tried the Crookes' Tubes imported for me by Queen & Co., and find they compare very favorably with those I saw at Mr. Crookes' house in London.

"Yours truly, HENRY DRAPER."

"Wishing you all success in your endeavors to furnish high-grade apparatus at a reasonable price I am,

"Very truly yours,

"GEORGE F. BARKER,

"Professor of Physics."

"NORTH-WESTERN UNIVERSITY,

"EVANSTON, ILL., Feb. 5th, 1881.

"JAMES W. QUEEN & Co., Philadelphia.

"Dear Sirs:—The set of Crookes' Tubes, which you imported for me, came in excellent order and give satisfaction. I have had the pleasure of exhibiting them before the Chicago Electrical Society, and several scientific gentlemen and electricians present expressed great gratification at the very perfect manner in which they demonstrate the new properties of residual gases in very high vacua. The reasonable price at which you furnish them puts them within the reach of all institutions interested in the latest scientific discoveries. Yours truly,

"H. S. CARHART,

"Prof. of Physics and Chemistry."

"MASS. INST. TECHNOLOGY, BOSTON, Feb. 16th, 1881.

"MESSRS. JAMES W. QUEEN & Co.,

"Gentlemen:—The Crookes' Tubes furnished by you have proved exceedingly satisfactory, are of good size, and capable of exhibiting the various phenomena which they are intended to show with quite a small induction coil.

"I am yours very truly,

"CHAS. R. CROSS."



# ELECTRICAL INSTRUMENTS FOR PRACTICAL PURPOSES.

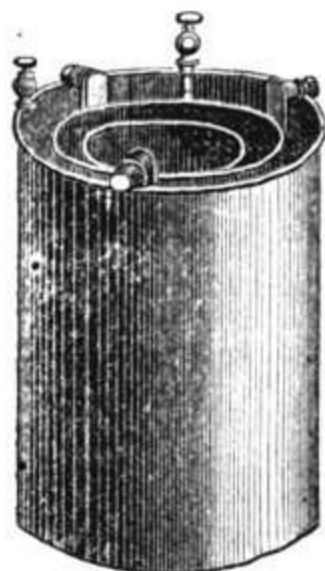

6000.

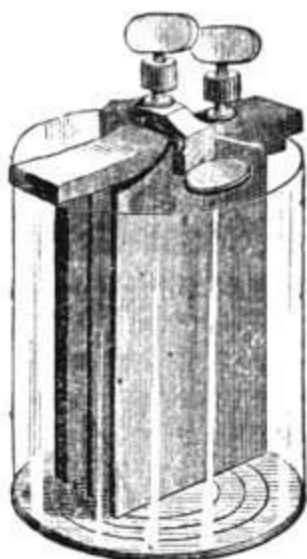

6001.



6004.

6000. **Sulphate of Copper Battery.** Double cell of copper, supporting cell of zinc by means of wooden insulators. Cell 9 inches high, \$5 00

6001. **Smee Battery, with Carbon Plates,**

	No. 1. 3x5.	No. 2 4½x7½.	No. 3. 4x8.	No. 4. 6x10.
Cell complete, . . . . .	\$2 50	\$2 75	\$3 50	\$5 00
Glass jar only, . . . . .	30	30	37	35
Zincs, per pair, . . . . .	50	60	95	1 60
Carbon and connector, . . . . .	75	90	1 20	1 75
“ connector, . . . . .	18	18	18	18
“ insulator, . . . . .	9	9	10	10
Clamp, . . . . .	60	60	60	60
Wood support, . . . . .	8	8	10	10

6002. **Smee Battery, with Platinized Silver Plates,**

	No. 1. 3x5.	No. 2. 3½x7½.	No. 3. 4x8.	Kidder. 2½x4½.
Size of zinc plates, . . . . .	3x5.	3½x7½.	4x8.	2½x4½.
Cell complete, . . . . .	\$3 00	\$3 75	\$5 25	\$2 50
Jar (glass), . . . . .	30	30	37	45
Platinized silver plate, . . . . .	1 50	2 00	3 00	*1 50
Connector, . . . . .	18	18	18	—
Zincs, per pair (rolled), . . . . .	50	60	95	40
Zinc clamp, . . . . .	60	60	60	40
Wood support, . . . . .	8	8	10	—

6003. **Smee Carbons, with Connections for Electrotyping Baths.**

	9x10.	10x12.	Laced connections, . . . . .	10x12.	12x12
Plain connections, . . . . .	\$3 25	\$3 75		\$5 50	\$6 60

Platinums and platinized silver plates for battery purposes made to order at short notice.

\* With connector.

6004. **Grenet Battery.** Bottle form. This is the most convenient and powerful of all batteries for the lecture table. The zinc electrode can be raised out of the solution when not in use, and thus adjusted the cell can remain for weeks without any action, if desired, and be ready at a moment's notice. Perhaps one of the best proportions for the solution is as follows: One gallon of water, one pound of bichromate of potash, and from half-pint to a pint of sulphuric acid, according to the energy of action desired. A small quantity of nitric acid added to the solution increases the constancy of the battery.

	No. 1.	No. 2.	No. 3.	No. 4.	No. *4½.	No. 5.	No. *5½.
Height.	6 inches.	8 inches.	10 inches.	12 inches.	12 inches.	14 inches.	14 inches.
Capacity,	½ pint.	1 pint.	1 quart.	½ gallon.	½ gallon.	1 gallon.	1 gallon.
Complete	\$2 00	\$3 50	\$4 50	\$5 50	\$9 00	\$12 00	\$15 00
Extra zincs.	25	25	30	30	30 each.		

\* Have double zincs and carbons.

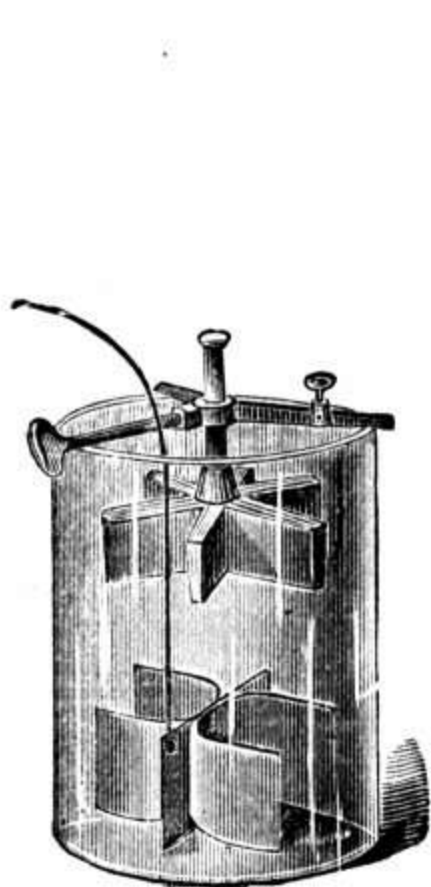

6005.

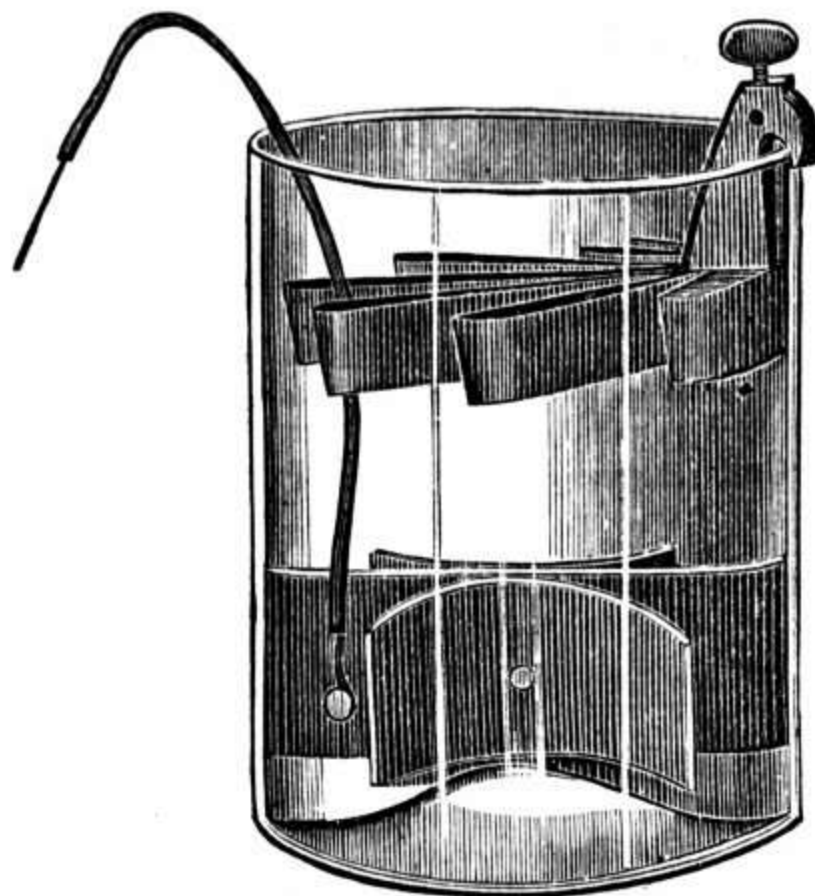

6006.

6005. **Gravity Battery.**

	5x7. No. 1. Main.	6x8. No. 2. Local.	6x8, No. 3. Ex. H. Local.	6½x7, No. 4. W. U. Local.
Cell complete,	\$0 90	\$1 00	\$1 20	\$1 25
Jar only,	30	35	35	
Zinc only,	30	35	45	40
Hanger only,	20	20	20	50
Copper only,	18	20	20	25

6006. **Crowfoot Gravity Battery.**

	Main. 5x7.	Local. 6x8.
Cell complete,	\$0 70	\$0 85
Jar,	25	30
Zinc, with hanger and connector,	28	35
Copper,	18	20

6007. Lockwood Battery.

No. 2, per cell complete,	\$1 50	Copper complete,	. . .	\$0 45
Jar, 5x11,	. . . 50	" top spiral,	. . .	18
Zinc,	. . . 30	" bottom spiral,	. . .	15
" support,	. . . 10	" bolts and nuts,	. . .	15
" connection,	. . . 15	" insulated wire,	. . .	16

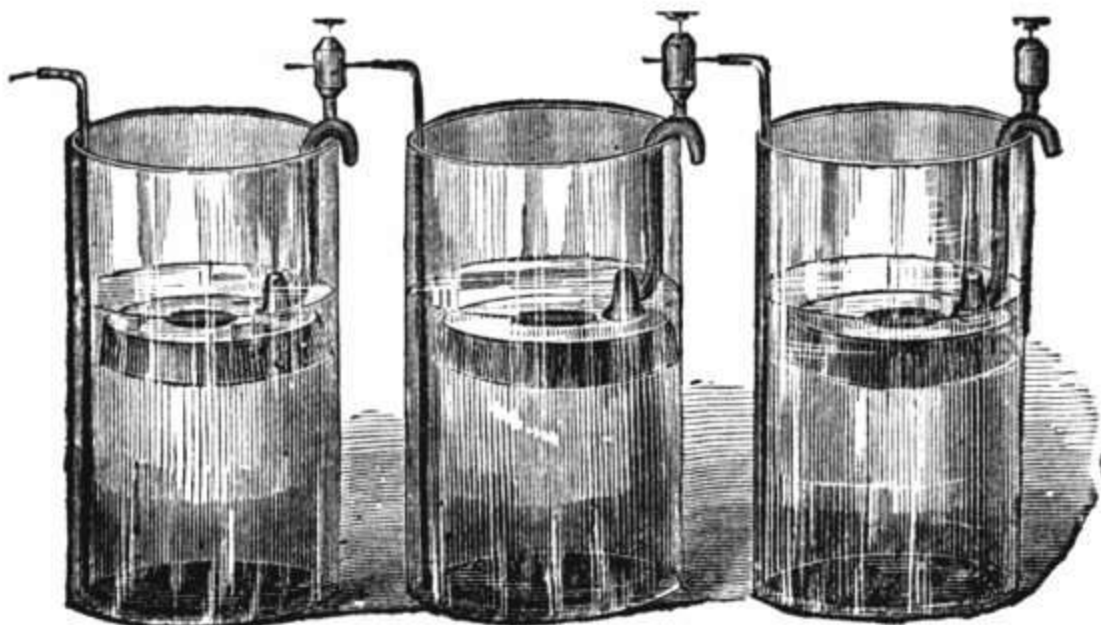

6008.

6008. Hill Battery.

	Student's No. 0. 4x5.	Main. No. 1. 4½x6.	Main. No. 2. 5x6.	Local No. 3. 6x6.
Cell complete,	. . . . \$0 60	\$0 80	\$9 90	\$1 00
Copper,	. . . . 12	15	15	18
Hanger,	. . . . 12	15	15	15
Jar,	. . . . 20	30	35	40
Zinc,	. . . . 20	25	30	40

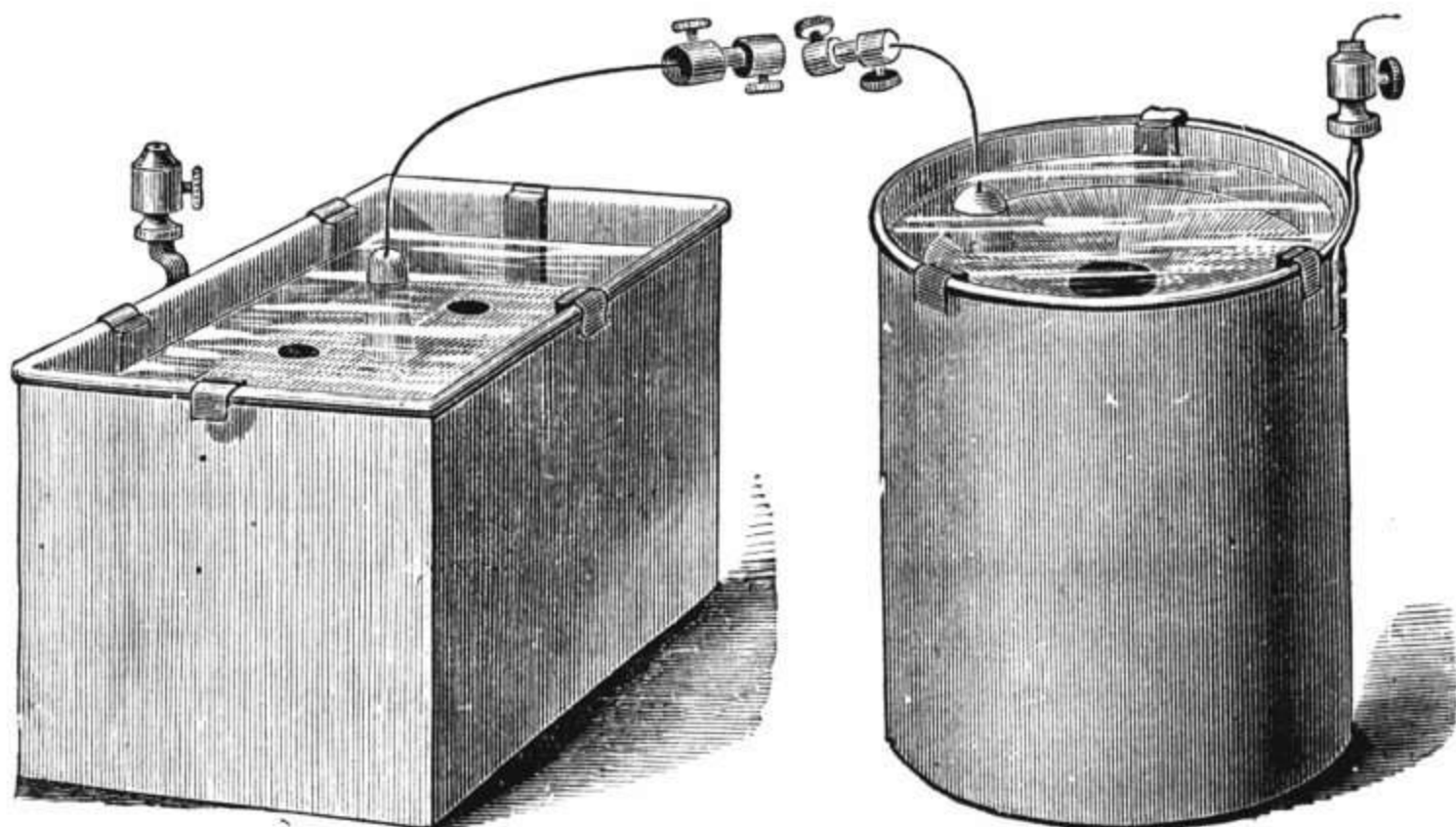

6009.

6009. **Eagles' Metallic Battery.**

	Round Cell. Main.	Square Cell. Local.
Complete, . . . . .	\$1 50	\$2 00
Lead Jar, . . . . .	1 05	1 45
Zinc, with wires attached, . . . . .	35	45
Insulating Fenders per set, . . . . .	12	12

Other sizes than the above, for special uses, furnished to order.

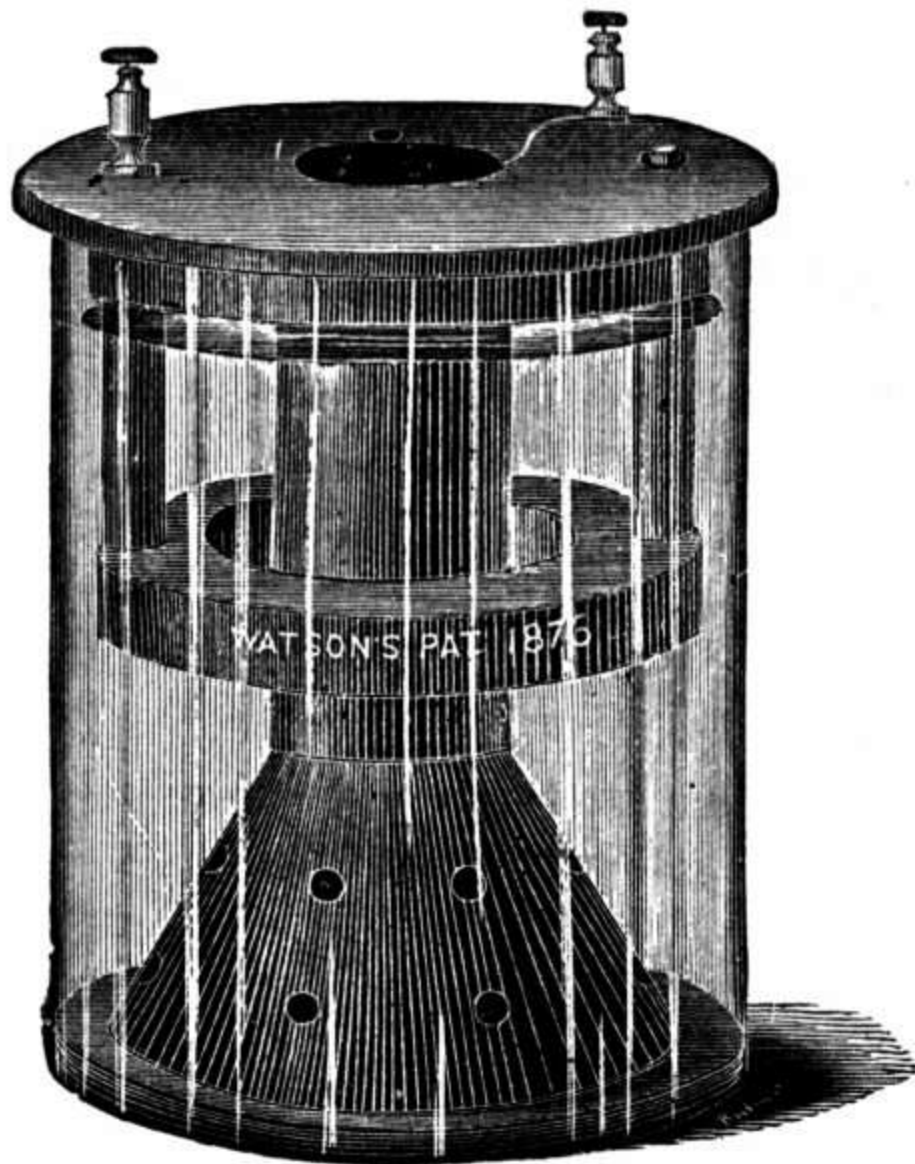

6010.

6010. **The Watson Battery.** Patented May 30th, 1876.

Complete Cell, . . . . .	\$1 50
Jar, 6x8 inches, . . . . .	30
Zinc, . . . . .	35
Zinc Connections, . . . . .	15
Lead Negative, with Connection, . . . . .	55
Cover (Porcelain), . . . . .	15

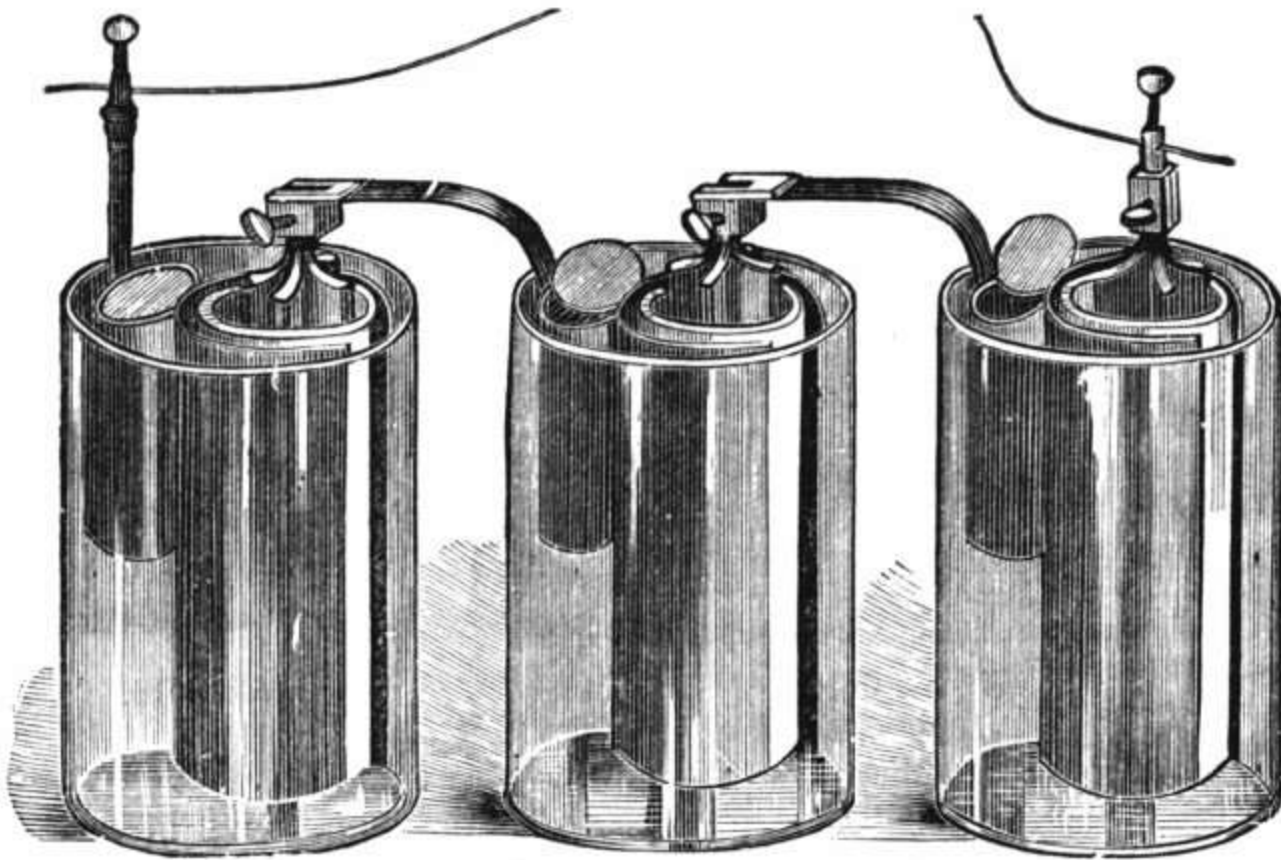

6011.

6011. Daniell Battery.

Local.	Main, French Pattern.
Cell, complete (glass jar), \$1 50	Cell, complete (glass jar), . . . \$0 75
Copper, with pocket, . . . 50	Copper, with zinc complete, . . . 40
Porous Cup, white, best, . . . 20	Porous Cup, glazed top, . . . 20
Glass Jar, . . . . . 35	Glass Jar, . . . . . 20
Zinc, . . . . . 35	
“ Clamp, . . . . . 20	
Earthen Jar only, . . . . . 25	



6015.

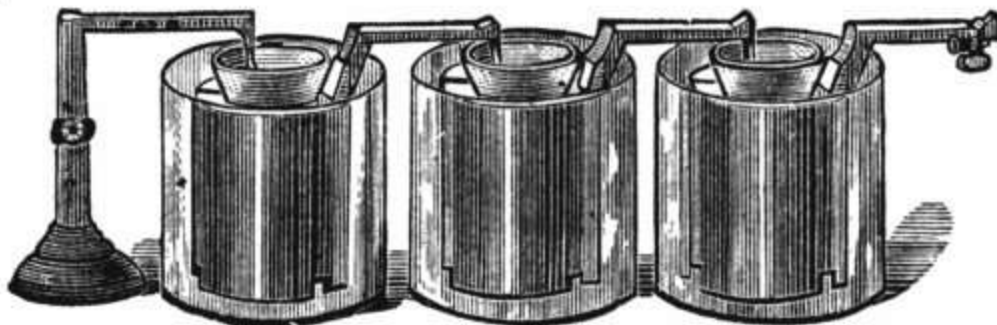

6015.

6015. Grove Battery. Main.

Per Cell, . . . . .	\$1 60
Platinum, . . . . .	80
Porous Cup, . . . . .	15
Jar, 4x4, . . . . .	25
Zinc, . . . . .	45
Grove Battery, Platinum Standard, . . . . .	50

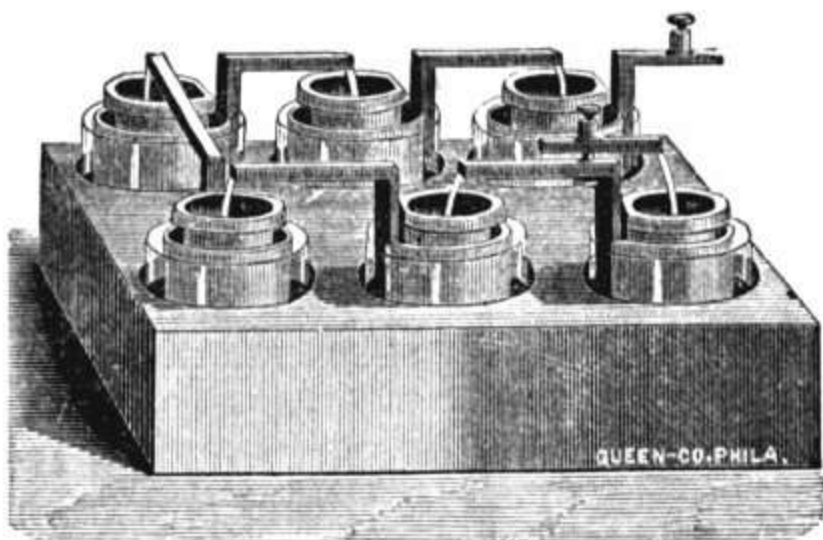

6016.

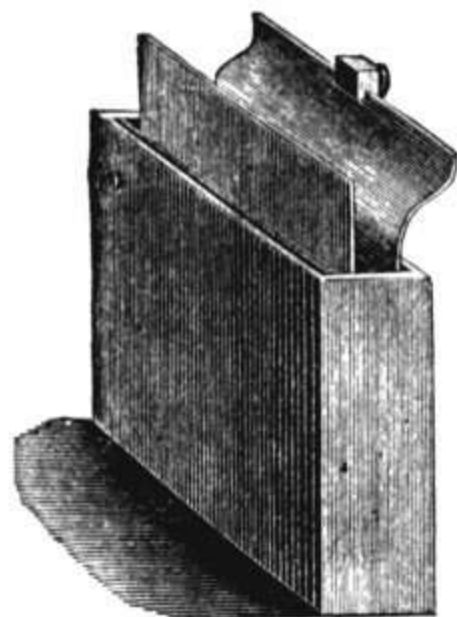

6018.

6016. Set of six cells, similar to 6015, in neat tray, . . . . .	\$12 00
6017. Set of nine cells, similar to 6016, in neat tray, . . . . .	17 50
6018. Improved form. Flat cell of hard rubber. Platinum, 6 inches long by 2½ inches wide, . . . . .	5 00
6019. Improved form. Set of ten cells, similar to 6018, in neat tray, . . . . .	52 50
6020. Improved form. Set of fifty cells, similar to 6018, in neat tray for the electric light, . . . . .	225 00

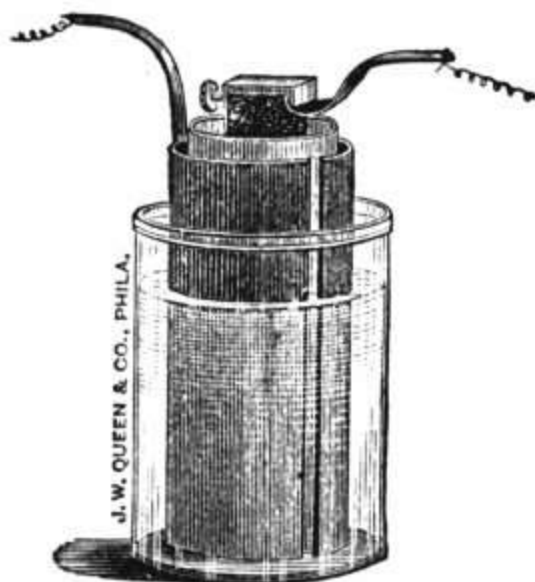

6021.

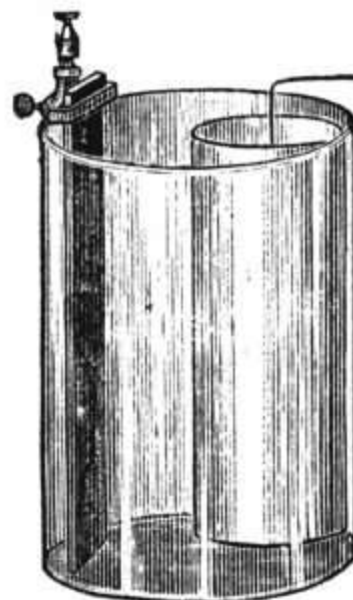

6022.

6021. Bunsen Battery.

	3 in. ½ pt.	4¾ in. 1 pt.	5 in. 1 qt.	6 in. 2 qts.	8 in. 1 gal.	12 in. 2 gals.
Cell complete, . . . . .	\$0 90	\$1 20	\$1 50	\$2 00	\$3 00	\$5 75
Glass Jar, . . . . .	12	20	25	30	35	75
Zinc and connector, . . . . .	30	40	60	70	1 10	1 75
Porous Cup, . . . . .	12	13	15	20	25	75
Carbon, . . . . .	10	12	12	35	50	1 40
“ connection, . . . . .	25	40	40	45	80	1 10

6022. Fuller's Mercury Bichromate Battery. New Style. With Improved Platina-faced Connections to Carbons, much Superior to the old style Lead Connections.

SIZES OF GLASS JAR.		No. 1. 5x6 inches.	No. 2. 6x8 inches.
Cell complete, . . . . .		\$1 00	\$1 30
Carbon, . . . . .		15	20
Carbon Connection, Platina Face, . . . . .		25	25
Carbon Clamp, . . . . .		10	15
Porous Cup, . . . . .		15	20
Glass Jar, . . . . .		25	30
Zinc, . . . . .		15	20
Zinc connectors, extra, each, 15 cents.			

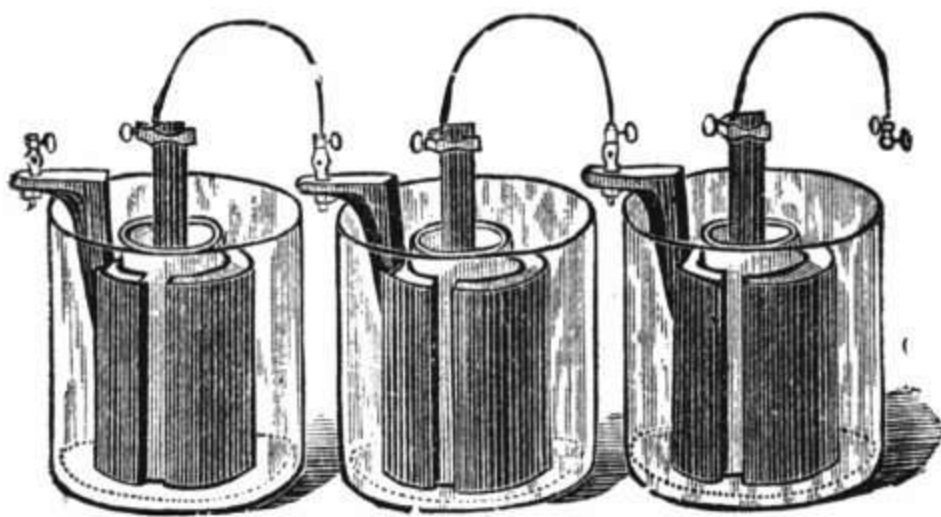

6023.

6023. Carbon Battery.

	No. 1. 4x4.	No. 2. 4½x4½.	No. 3. 6x8.
Cell complete, . . . . .	\$1 35	\$1 70	\$4 25
Jar only, . . . . .	25	25	35
Zinc only . . . . .	40	50	2 25
“ Connector, . . . . .	15	15	20
Porous Cup only, . . . . .	12	12	25
Carbon only, . . . . .	12	35	50
“ Connector, . . . . .	22	22	50
“ Clamp, . . . . .	10	15	25

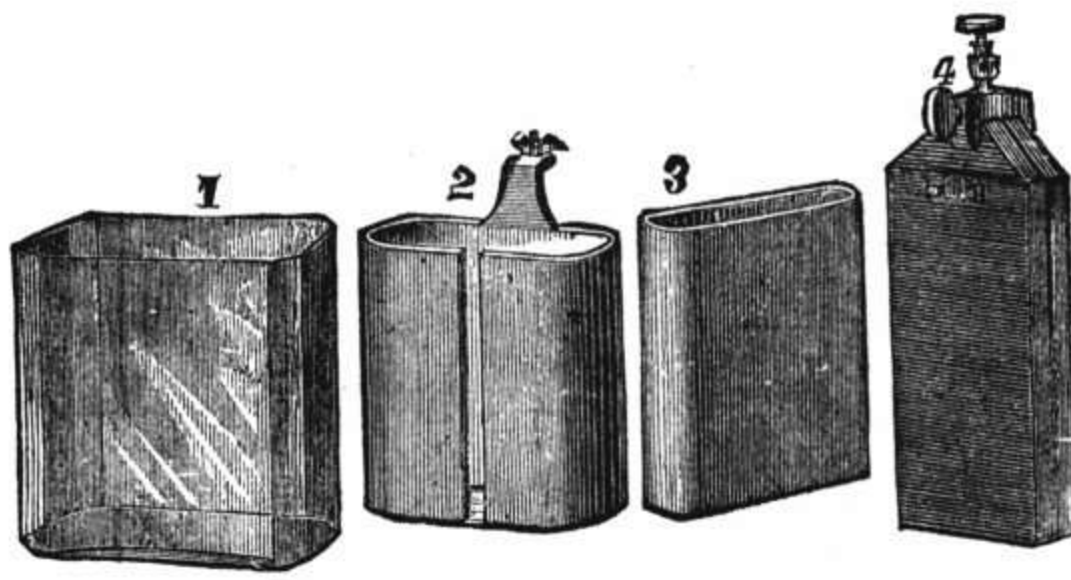

6030.

6030. **Hanson and Van Winkle Nickel-Plating Battery.** An improved Bunsen Cell of great power, for nickel and electro-plating, striking, electro-motors, etc. One hundred gallons of nickel solution have been used successfully with two of these cells. The glass jars contain six quarts, forming a very convenient tank for experimental work.

Cell complete, . . . . .	\$5 00
Carbon, 1x4½x9, . . . . .	1 60
Carbon Clamp, Platinum Faced, . . . . .	1 00
Porous Cup, . . . . .	50
Glass Jar, 6x8x9 inches, . . . . .	1 00
Zinc, Heavy Rolled, . . . . .	1 00
Zinc Connector, . . . . .	15

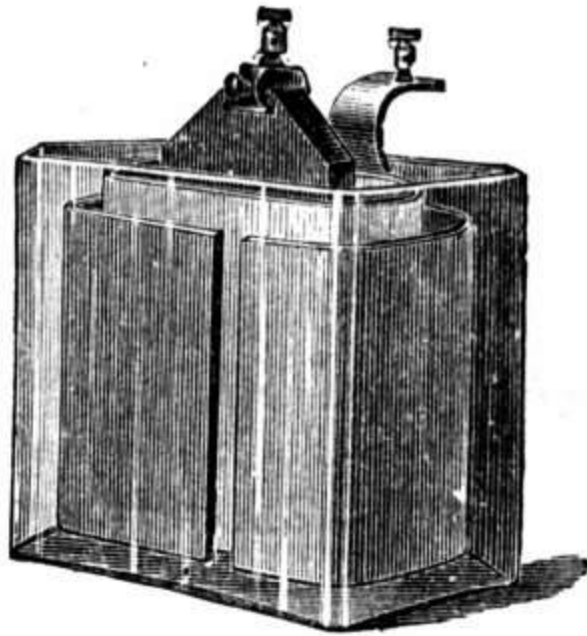

6030

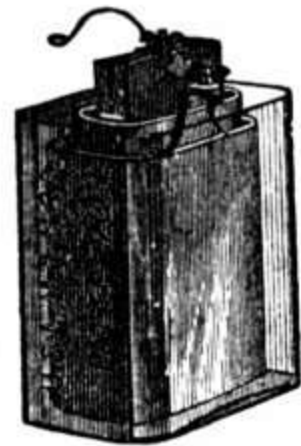

6031

6031. **Nitro-Chromic Battery.**

Per Cell, complete, . . . . .	\$5 00
Carbon, . . . . .	1 60
Carbon Connection and Clamp, . . . . .	65
Glas Jar, 5x8x8½ inches, . . . . .	75
Porous Cup, . . . . .	50
Perforated Rubber Partition, . . . . .	15
Zinc, . . . . .	1 50
Zinc Connection, . . . . .	15
Copper Connecting Strap, . . . . .	05
Compound Nitro-Chromic Salts, per lb., . . . . .	30

6035. **The Leclanche Prism Battery.** In this Battery the porous cup is dispensed with, and in its place is substituted a pair of compressed "prisms" or plaques, which are simply attached to the carbons by means of two rubber bands. The "prisms" contain all of the materials heretofore employed in the porous cup, combined with others not before used, compressed into this compact and convenient form by powerful hydraulic machinery.

Complete Cell, . . . . .	\$1 65
Prisms, per per, . . . . .	1 00
Carbon, mounted, complete, . . . . .	30
Glass Jar, . . . . .	18
Glass Jar Top, . . . . .	12
Zinc, . . . . .	10
Sal-ammoniac, put up in bag, . . . . .	08



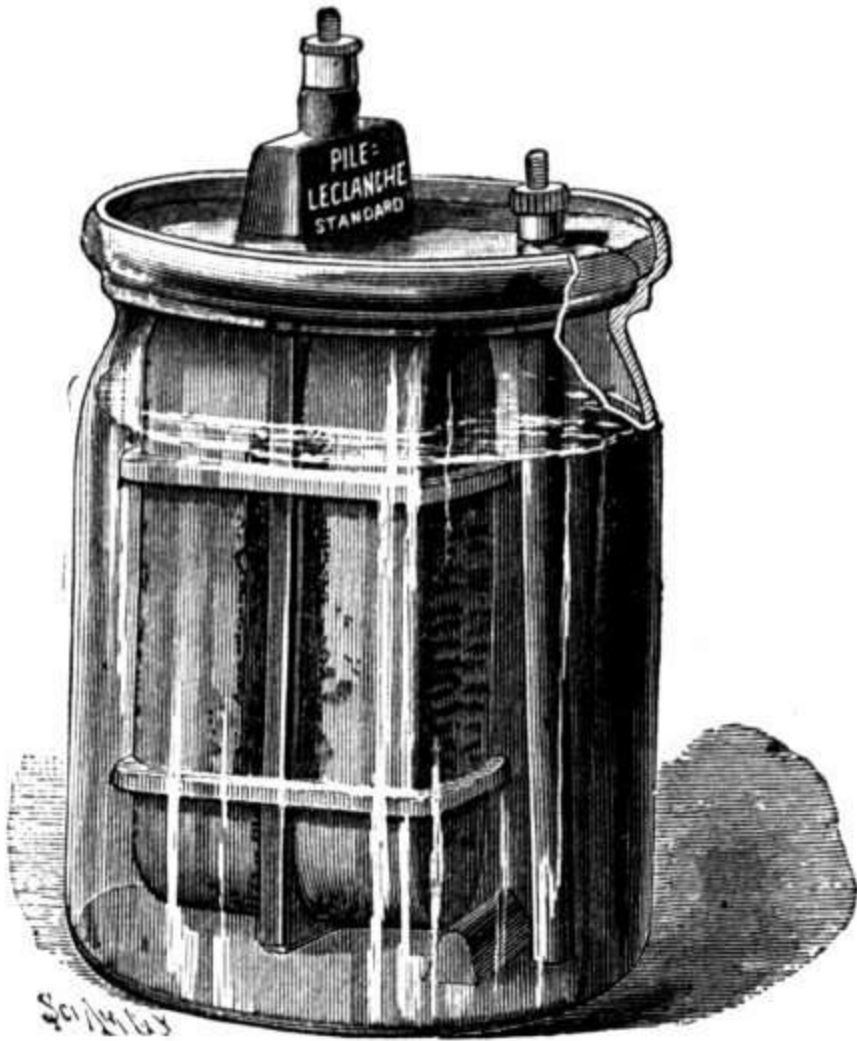

6035.

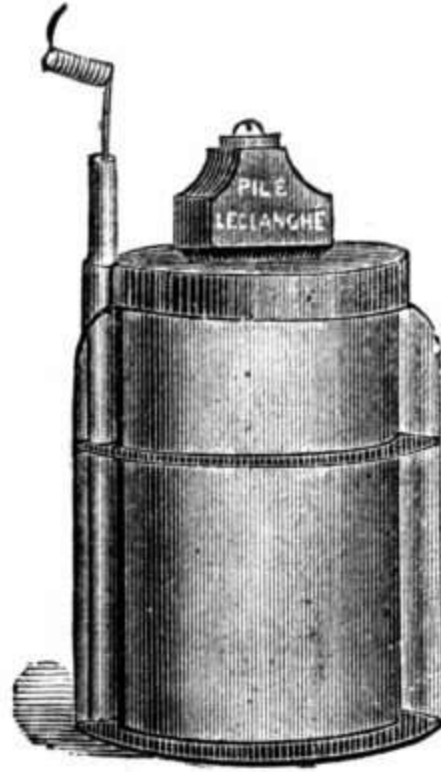

6036.

6036. **The Disque Leclanche Battery.** While we recommend the new style Prism Battery as the best form of Leclanche Battery, we shall keep in stock the old Style of "Disque" Battery, at the following reduced prices:

Cell complete, 4½x6 incs,	\$1 25	Zinc, amalgamated,	. . . . .	10
Porous Cell, charged,	. 1 00	Sal-ammoniac,	. . . . .	08
Jar,	. . . . . 18	Sealing extra per cell,	. . . . .	20

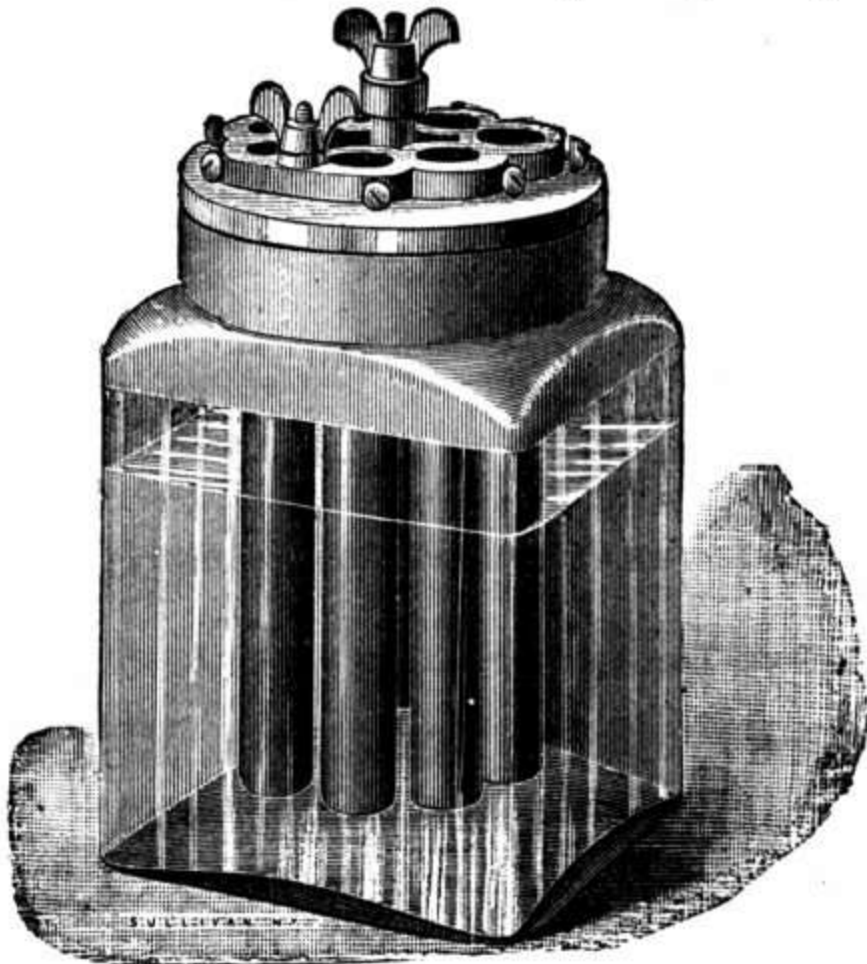

6037.

6037. **The Diamond Carbon.**

Price, complete, \$1 25

Jar only, each, . . . . .	\$0 15
Jar Top only, each, . . . . .	15
Carbon Ring (connector), . . . . .	10
Long Carbon and Connector, . . . . .	30
Each short Carbon, . . . . .	08
Plain Zincs, . . . . .	10
Zinc Connector, . . . . .	05
Mercury Cup, . . . . .	10
Sal-ammoniac, . . . . .	08

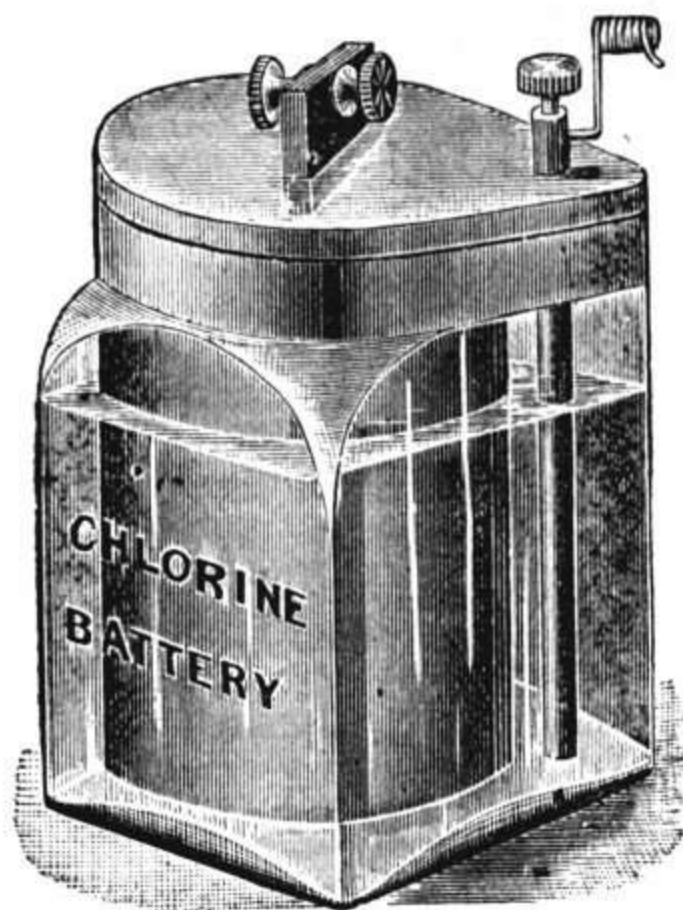

6038.

6038. **The Fitch Chlorine Battery.** Patented September 16th, 1879.

Price per cell, complete, . . . . .	\$1 50
“ “ porous cell, . . . . .	1 25
“ “ glass jar, . . . . .	20
“ “ zinc, amalgamated, . . . . .	12
“ “ sal-ammoniac, put up in bag, . . . . .	08
“ “ “ per lb., . . . . .	20

We also furnish the battery sealed at an additional cost of twenty cents per cell.

6040. **Diamond Thermo-Electric Batteries.**

	No. of Elements.	Electromotive Force.	Internal Resistance.	Quantity of Gas used per hour.	Price.
No. 1.	50 large size,	1.8 volts,	$\frac{3}{10}$ Ohm,	about 350 litres.	180 fr.
“ 2.	100 “ “	3.6 “	$\frac{6}{10}$ “	“ 450 “	300 “
“ 3.	150 small “	5.4 “	2 “	“ 350 “	180 “

Imported to order.

6045. Pressed Carbons for Battery and other purposes.

Long.	Inches Wide.	Thick.	Cents Each.	Long.	Inches Wide.	Thick.	Cents Each.
3	2	$\frac{1}{4}$	05	10	6	$\frac{1}{2}$	68 $\frac{3}{4}$
4 $\frac{1}{4}$	1 $\frac{3}{8}$	$\frac{1}{4}$	06 $\frac{1}{4}$	11	6	$\frac{1}{4}$	50
4 $\frac{3}{4}$	1 $\frac{3}{8}$	$\frac{1}{4}$	06 $\frac{1}{4}$	11	6	$\frac{3}{8}$	62 $\frac{1}{2}$
5 $\frac{1}{4}$	1 $\frac{7}{8}$	$\frac{1}{4}$	08 $\frac{3}{4}$	11	6	$\frac{1}{2}$	75
6	1 $\frac{3}{4}$	$\frac{5}{8}$	08 $\frac{3}{4}$	11	9	$\frac{1}{4}$	75
6	1 $\frac{1}{4}$	$\frac{5}{8}$	20	11	9	$\frac{3}{8}$	94
6	3	$\frac{1}{2}$	25	11	9	$\frac{1}{2}$	1 13
7	1 $\frac{1}{2}$	$\frac{1}{4}$	07 $\frac{1}{2}$	12	6	$\frac{1}{4}$	62 $\frac{1}{2}$
7	4 $\frac{1}{2}$	$\frac{1}{4}$	37 $\frac{1}{2}$	12	6	$\frac{3}{8}$	75
8	5 $\frac{3}{4}$	$\frac{1}{8}$	31 $\frac{1}{4}$	12	6	$\frac{1}{2}$	87 $\frac{1}{2}$
8	5 $\frac{3}{4}$	$\frac{1}{8}$	37 $\frac{1}{2}$	12	12	$\frac{1}{8}$	94
9	2	$\frac{1}{8}$	31 $\frac{1}{4}$	12	12	$\frac{1}{4}$	1 25
9	4 $\frac{1}{2}$	$\frac{1}{2}$	43 $\frac{3}{4}$	12	12	$\frac{3}{8}$	1 57
9	6	$\frac{1}{8}$	31 $\frac{1}{4}$	12	12	$\frac{1}{2}$	1 88
9	6	$\frac{1}{4}$	43 $\frac{3}{4}$	18	12	$\frac{1}{4}$	2 25
9	6	$\frac{3}{8}$	56 $\frac{1}{4}$	18	12	$\frac{3}{8}$	2 63
9	6	$\frac{1}{2}$	68 $\frac{1}{4}$	18	12	$\frac{1}{2}$	3 75
10	6	$\frac{1}{4}$	43 $\frac{3}{4}$	18	12	$\frac{3}{4}$	5 50
10	6	$\frac{3}{8}$	56 $\frac{1}{4}$				

Special sizes cut, or made from molds at short notice.

Carbon buttons $\frac{3}{8} \times \frac{3}{16}$ per 100,	.	.	.	.	.	.	\$4 00
" " $\frac{1}{16} \times \frac{1}{32}$ " "	.	.	.	.	.	.	8 00

ZINCS AND OTHER ACCESSORIES.

For ordinary battery zincs see prices of batteries.

6050. Zinc plates rolled, 3x4 thickness $\frac{1}{8}$ to $\frac{3}{8}$ per lb.,	.	.	.	.	.	\$0 30
6051. " " " 4x4 to 6x9, " $\frac{1}{8}$ to $\frac{3}{8}$ " "	.	.	.	.	.	25
6052. " " " over 6x9, " $\frac{1}{8}$ to $\frac{3}{8}$ " "	.	.	.	.	.	20
6053. Platinum Strips, 3x1, for Grove batteries,	.	.	.	.	.	75
6054. " " 6x2 $\frac{1}{2}$ " " " "	.	.	.	.	.	3 00
6058. Ordinary Single Carbon Clamp for Batteries,	.	.	.	.	.	15
6059. " Double " " " "	.	.	.	.	.	25
6060. Carbon Clamp and Connection,	.	.	.	.	.	35
6061. Daniell Zinc Clamp,	.	.	.	.	.	25

BATTERY DIRECTIONS.

**Battery Acid**, or Electropoion Fluid. Mix well 100 parts of water, 12 of Potassium bichromate, and 25 of sulphuric acid. Great care should be taken in adding the acid, as it generates great heat. A gallon of water, a pound of bichromate, and a pint of sulphuric acid, is in about the same proportion as the above. A small quantity of nitric acid added to the solution increases the constancy of the battery.

**To Amalgamate Zincs.** This may be very well done by first immersing the zincs in a solution of dilute sulphuric acid and then in a bath of mercury. A brush or cloth may be used to rub them, so as to reach all points of the surface. Where a large quantity is to be amalgamated, the following will be found to be a good method: Dissolve eight ounces of mercury in a mixture consisting of two pounds of hydrochloric and one pound of nitric acid; when the solution is complete, add three pounds more of hydrochloric acid. The zinc is amalgamated by immersing it in this solution for a few seconds, quickly removing to a vat of clear water and rubbing it, as in the first case, with a brush or cloth. If the solution is kept in a covered vessel it may be used a number of times.

**Sulphate of Copper Battery.** Amalgamate the zinc, suspend it in the copper cell, and fill the latter with saturated solution of copper sulphate.

**Smee Battery.** This battery is charged with a solution of one part sulphuric acid to seven of water. The plates are connected to the clamp and placed in a jar. In this battery, above all, the precaution of amalgamating the zinc should never be neglected. With an unamalgamated zinc the results are very unsatisfactory. Care should be taken that the fluid does not wet the supporting cross-pieces.

**Grenet Battery.** Fill the globe of the battery very nearly full of battery acid prepared as above. See that the zinc, when drawn to the top of the jar, does not touch the fluid.

**Gravity Battery.** Unfold the copper strip so as to form a cross, and place it in the bottom of the jar.

Suspend the zinc about four inches above the copper, from the tripod, which has a hole to receive the wire from the copper of the next cup.

Pour clean water into the jar so as to cover the zinc. Then drop in blue vitriol in small lumps, not over six or eight ounces per cup at one time.

The resistance may be reduced and the battery be made immediately available by drawing about half a pint of solution of sulphate of zinc from a battery already in use and pouring it into the jar; or, when this cannot be done, by putting into the liquid four or five ounces of pulverized sulphate of zinc.

Blue vitriol should be dropped into the jar as it is consumed, care being taken that it goes to the bottom. The need of blue vitriol is shown by the fading of the blue color, which should be kept as high as the top of the copper, but should never reach the zinc.

After the battery has been started no further attention is required, except to keep it supplied with blue vitriol, until the quantity of sulphate of zinc in solution has become too great. In that case draw out a portion of the top of the liquid with a syringe or a cup and replace it with clear water.

As long as the battery continues in action there is an increase of the quantity of sulphate of zinc in solution in the upper part of the jar.

A hydrometer is convenient for the purpose of testing the strength of this solution.

When the specific gravity is less than 15 degrees, there is too little sulphate of zinc; when it is 35 degrees or over, there is too much in solution, and it must be diluted.

When the zincs become coated so as to interfere with the action of the battery, they must be taken out and scraped clean and washed.

**Crowfoot Battery.** A form of gravity. Directions, the same.

**Lockwood Battery.** A form of gravity. Directions, the same.

**Hill's Battery.** A form of gravity. Directions, the same.

**Eagle Battery.** A form of gravity. Directions, the same.

**The Watson Battery.** A form of gravity. Directions, the same.

**Daniell Battery.** The manner of setting up this battery is as follows: The pocket is filled with blue vitriol, and the jar and porous cup with clean water. If time is no object, the maximum strength may be attained by short circuiting the battery for a few hours, but if it is required for immediate use, a small quantity of sulphate of zinc may be added to the water in the porous cup. This is very similar to the gravity battery, and the directions given for the latter will in the main apply to it.

**The Grove Battery.** The glass jar is filled with dilute sulphuric acid, about one part of acid to twenty of water, and the porous cup with fuming nitric acid, about 40°. The platinum plate being placed in the porous cup and the zinc in the glass jar, the battery is ready for use. The plates should be removed and cleaned and the nitric acid emptied out when the battery is not in use. The binding screws should be examined and the zincs amalgamated before again setting up the battery.

**The Bunsen Battery.** **FIRST.** Fill the porous cup with electropon fluid, and the glass jar with ten or twelve parts water to one of acid, previously mixed and allowed to cool.

**SECOND.** For the most intense effects fill the porous cup with nitric acid, 40°, clear or saturated with potassium bichromate to suppress the fumes. Fill the glass jar same as before.

**Caution.** The zincs must be kept well amalgamated. The platinum-faced side of connector must always be put against carbon. If the connectors become corroded, they must be brightened with a file. Never file the platinum.

**The Fuller Bichromate Battery.** Mix together three ounces of bichromate of potash and a solution composed of one part sulphuric acid to nine of water. Fill the glass jar about one-third full of this mixture, put two ounces of mercury in porous cup, and place the latter in the jar. The zinc and carbon being put in place and the porous cup filled with water, the battery is complete. A supply of mercury should be kept in the porous cup so as to keep the zinc well amalgamated. When the battery weakens the solution assumes a greenish color; a little bichromate of potash should then be added to the solution in jar, a portion of that in porous cup removed, and its place supplied by fresh water.

**The Carbon Battery.** The amalgamated zinc is placed in the glass jar, the porous jar in the centre of the zinc cylinder, and the carbon in the porous jar. In the outer jar is sulphuric acid diluted with twelve times its weight of water and in the porous jar electropon fluid.

**H. & V. W. Nickel-Plating Battery.** Put the zinc in the outer or glass jar, and fill to top of zinc with a mixture of one part of sulphuric acid to twelve parts of water, previously mixed and allowed to cool. The fluids in the porous cup and outer jar should be of the same height. Into each porous cup put two ounces of nitric acid, and half fill the cup with a mixture of equal parts, by measure, of water and sulphuric acid. Place the carbon in the porous cup, and add the above mixture until it reaches the proper height, as mentioned below. When the liquid in the jar becomes milky, replace it with fresh solution. Add occasionally a little nitric acid to the liquid in the porous cells, and keep the zincs well amalgamated. Nitric acid at forty degrees, clear, or saturated with bichromate of potash, increases the intensity of this battery; or, if desired, the Carbon Battery fluid may be used. Bunsen Solution, No. 2, may be used for the most intense effect.

**Nitro-Chromic Battery.** Place zinc inside of glass jar, porous cup inside of zinc, and carbon inside of porous cups. Slide perforated division in end of porous cup, making a small cell. Pour six ounces of compound salts in small cell, and add 45° sulphuric acid till the porous cup is filled. In glass jar pour  $\frac{3}{4}$  of an inch of 45° sulphuric acid and add water till jar is filled.

**The Leclanche-Prism.** Attach prisms, one to each side, to the carbon pole-piece by means of the heavy rubber bands supplied with each cell; insert zinc and place the whole in the glass jar in which is the solution prepared as above. When this battery fails, and cannot be revived by the addition of fresh sal-ammoniac, new prisms must be used. The other directions apply equally well to this form.

**The Leclanche, Disque.** Put the sal-ammoniac accompanying each cell in the jar, fill one-third full of water, and stir till as much as possible of the sal-ammoniac is dissolved. Pour a little water in the hole in the porous cup, insert latter in jar, put in zinc, and connect battery. The solution should not reach higher than two-thirds of the jar to keep the salts from running over the edge. If the battery should fail to work, a fresh solution should be used, the old solution being thrown away. Should this not effect the desired result, the porous cups may be soaked in warm water. Should this fail, new porous cups must be used.

The inside of the rim of the jar should be greased to keep the salts formed from overrunning.

**The Fitch Chlorine Battery.**—Same as Leclanche.

**SECONDARY BATTERIES.**

PLANTE, FAURE, AND DE KABATH SECONDARY BATTERIES.

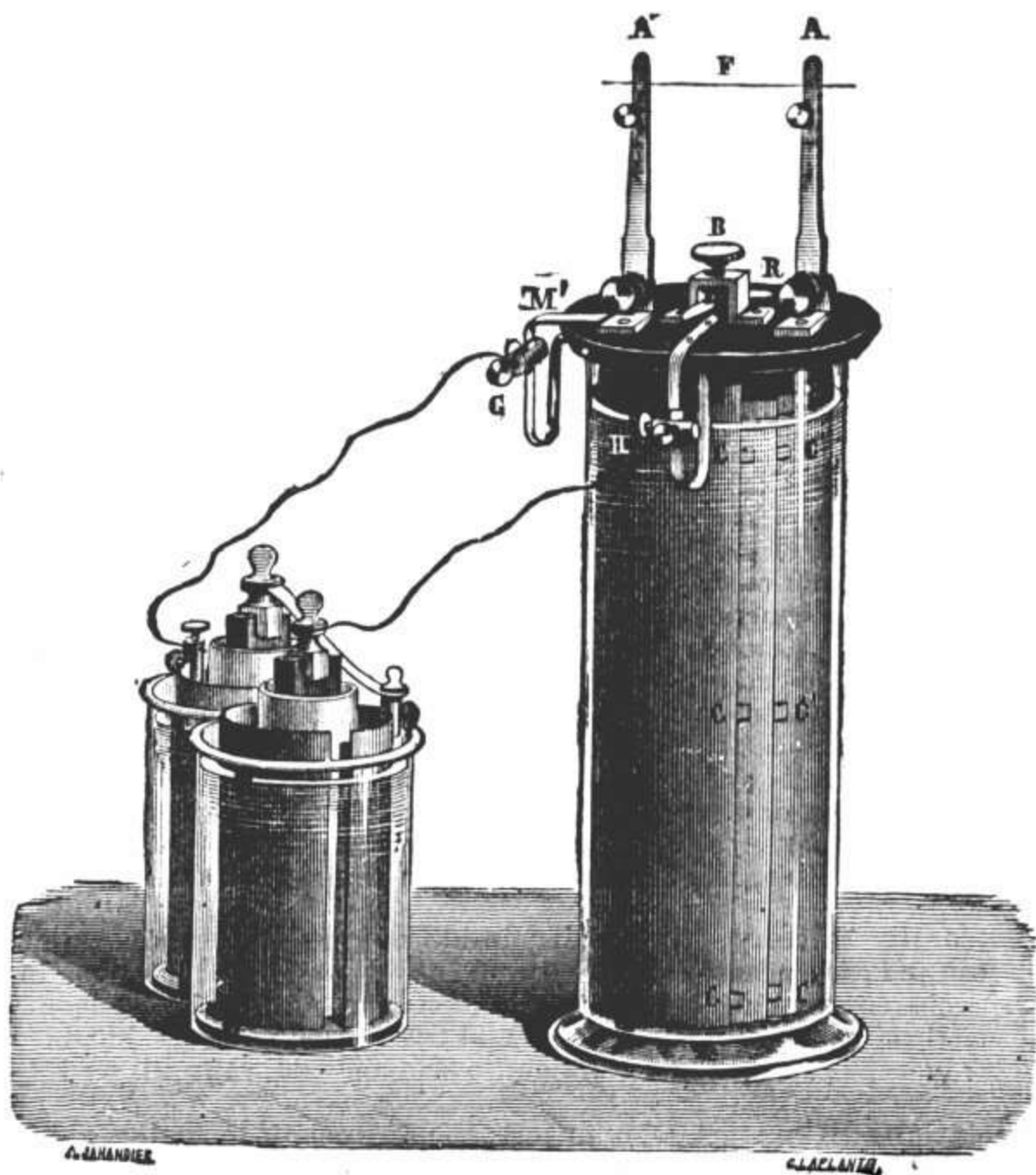

PLANTE'S SECONDARY BATTERY.

6075.	Plante's Secondary Batteries,	small element,	.	.	.	.	\$ 7 25
6076.	"	"	"	large	"	.	14 25

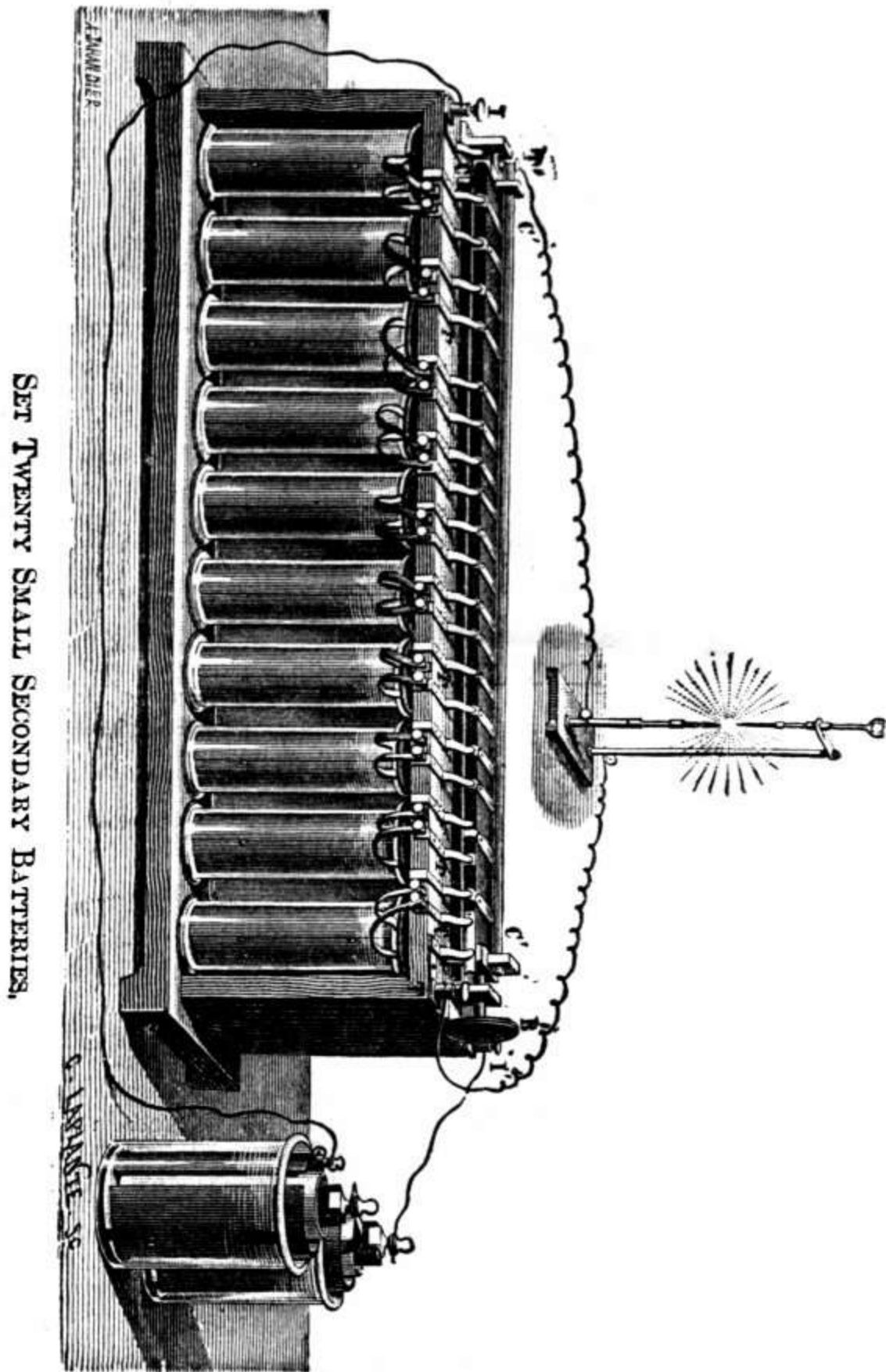

6077. 1 set 20 Small Plante Secondary Batteries, with Commutator for connecting in series or multiple arc, . . . . . 250 fr.
6078. Same, large size, . . . . . 650 fr.

Imported to order.

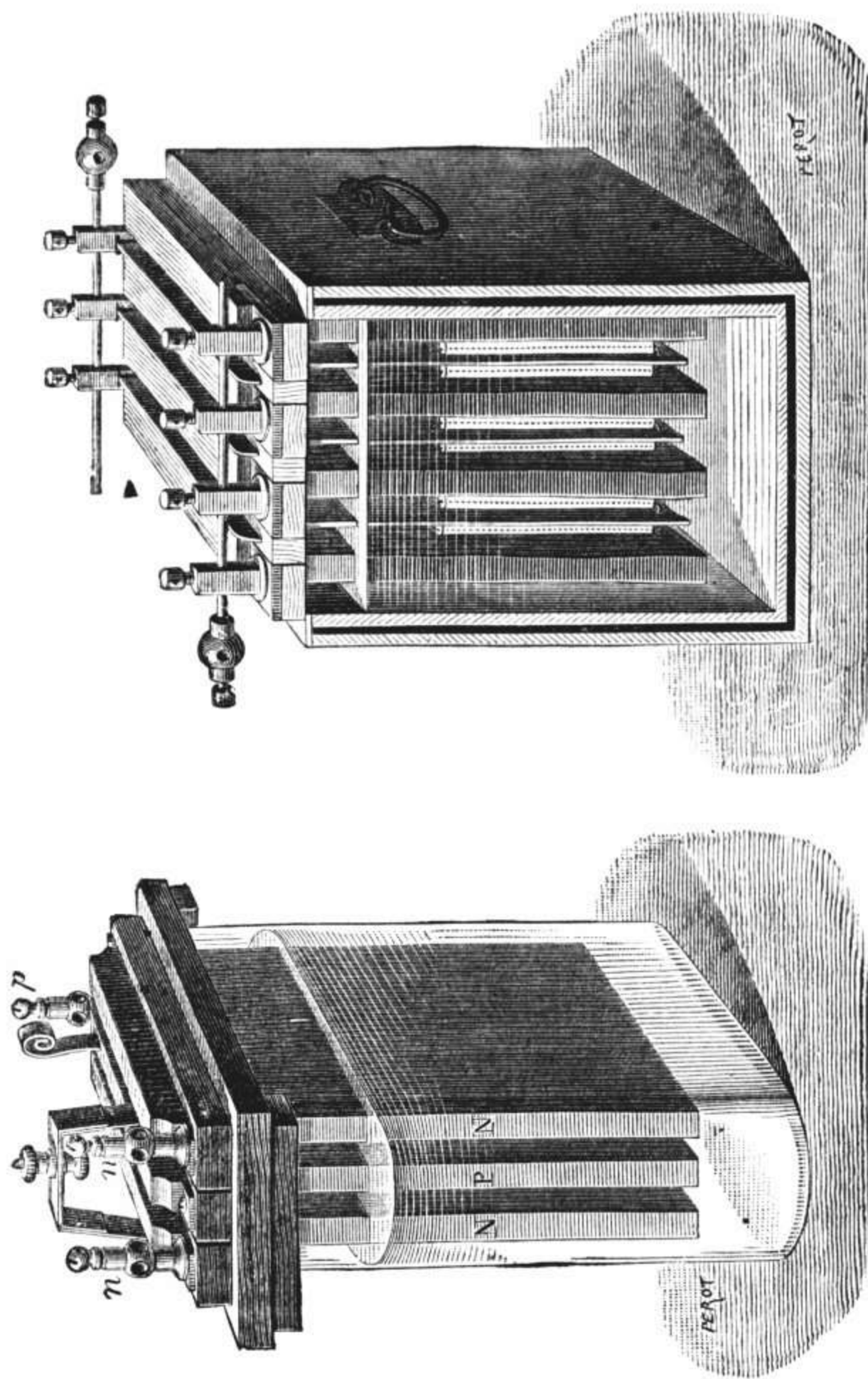

6079 (Fig. 2).

6079 (Fig. 1).

**6079. Faure Accumulators of Amalgamated Zinc. Reynier Make.**

These Secondary Batteries can be charged by the Dynamo Machines previously described.



Size,	Model, 1 plate. (Cut 1.) 205x105 x310 mm.	2 plates. 205x185 x345 mm.	4 plates. (Cut 2.) 185x185 x345 mm.
Weight of liquid, . . .	about 7	9	17.5 kilos.
Electro-motive force, . . .	" 2.35	2.35	2.35 volts.
Resistance, . . .	" 0.06	0.05	0.02 ohms.
Mean intensity of discharge, "	7	10	20 amperes.
Capacity of Accumulator after forming 200 hours, "	150,000	250,000	550,000 coulombs.
Price,	25	35	60 francs.

6080. **Faure Accumulator of Copper. Reynier Make.** (Cut 1.)  
Differs from the small model above only in the liquid used and its electro-motive force, which is about 1:3. Price, . . . . . 25 fr.

6081. **Plante Accumulator. Reynier Make.**

Size, . . . . .		205x105x350 mm.
Weight of liquid, . . . . .	about	11 kilos.
Electro-motive force, . . . . .	"	1.85 volt.
Resistance, . . . . .	"	0.04 ohm.
Mean intensity of discharge, . . . . .	"	8 amperes.
Capacity of Accumulator after forming 500 hours, . . . . .	"	150,000 coulombs.
Price, . . . . .		40 francs.

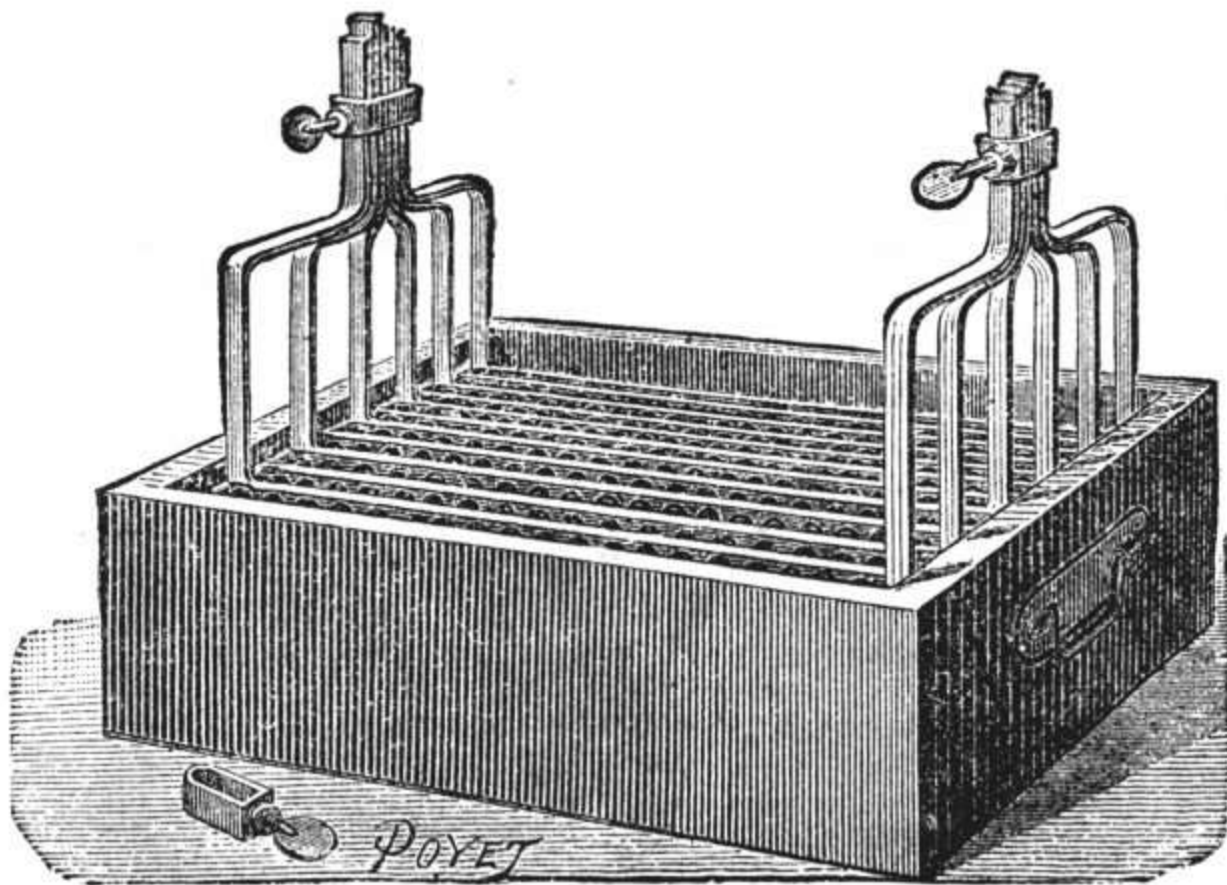

6082.

6082. **Kabath's Patent Electric Accumulators.**

	E. M. F.	Interior resistance in ohms.	Intensity in amperes.	Approximate weight.	Price.
Laboratory Model,	2, 2	.005	about 10	about 15 lbs.	35 fr.
Small Working Model,	2, 2	.005	" 30	" 52 "	75 fr.
Medium " "	2, 2	.005	" 60	" 105 "	125 fr.
Large " "	2, 2	.005	" 120	" 210 "	175 fr.

WE take pleasure in presenting the following Dynamo Machines for scientific use to the public.

We have them made so as to be especially adapted to the needs of the lecturer for demonstration, and also for practical use, thus largely superseding the troublesome battery even in the smaller schools.

The low prices at which we furnish these new machines bring them within the reach of nearly all schools.

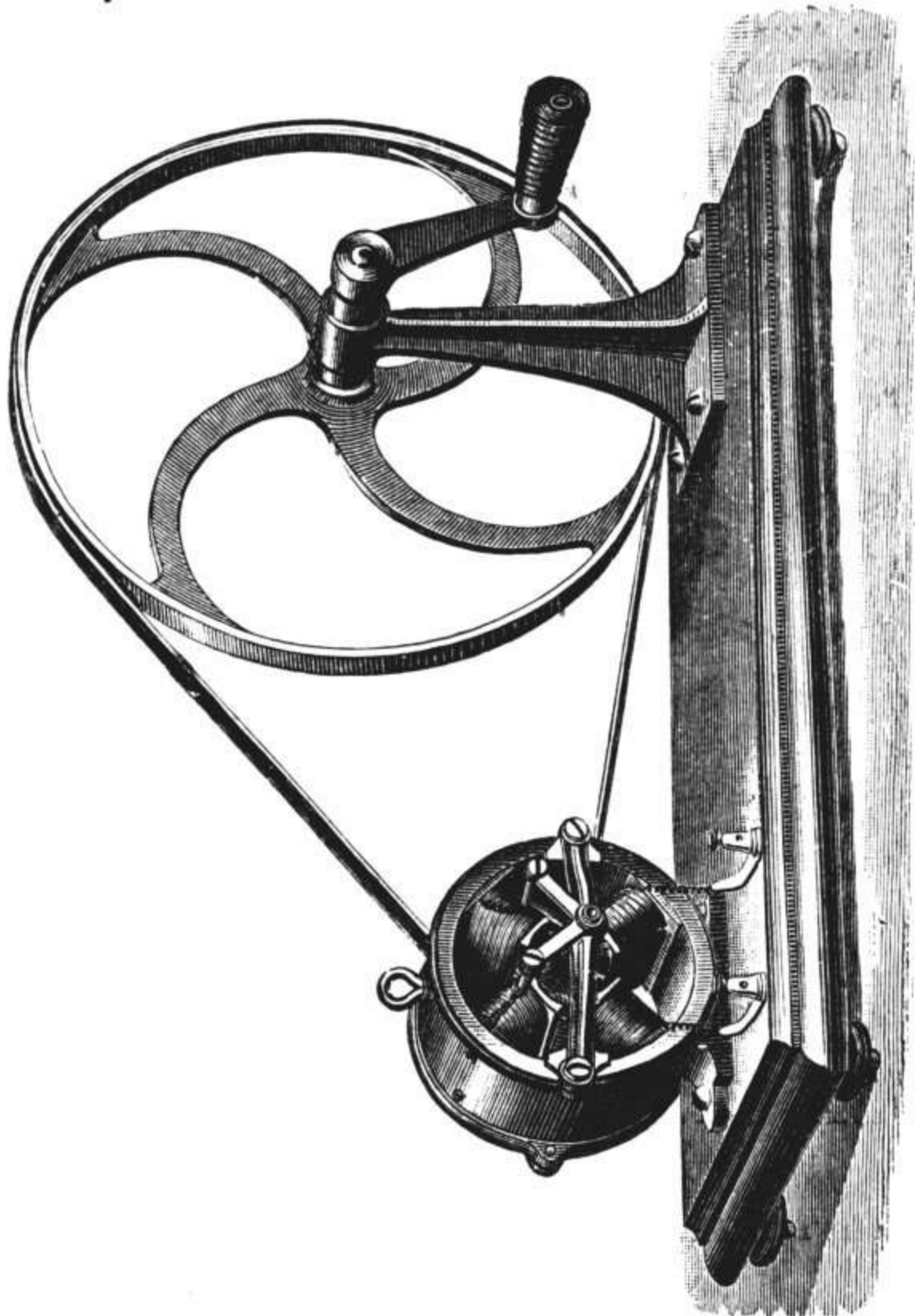

No. 1 DYNAMO-ELECTRIC MACHINE.

This little machine is a striking illustration of simplicity and compactness. Apparatus of this class is usually so complicated that much ingenuity is required to make it of small dimensions. The little Dynamo is composed of a cast-iron drum, inside of which four electro-magnets are fastened, forming inductors, whose polar surfaces are hollowed out to contain the armature. The inside armature is of wrought-iron, in the

form of a cross, the arms of which are wound with silk-covered wire. This cross is traversed by a steel axis, which has on one side the motive pulley, and on the other the commutator, to which the two ends of the wire are attached. Two brushes, placed at right-angles, rub upon the commutator and serve to receive the current generated by the revolving armature. The axis runs in bronze bearings. The whole apparatus is mounted on a mahogany base, with pulley and handle.

A few words will be necessary upon the theory of this machine. The field magnets of this machine are N. and S. successively. The result of this arrangement is, that two poles of the same kind are opposite each other—a north pole facing a north, and a south a south. The four arms of the cross in revolving come opposite the field magnets, and are thus themselves polarized, but in a contrary sense to the poles which influence them, that is, the two arms which are, so to speak, continuous or prolonged are polarized north and the other two south. In this way the cross forms what is termed a magnet with consequent poles, and it is this kind of magnet which is the most powerful. The rotation of the armature being continuous, at each quarter of a revolution the polarities of the arms of the cross are reversed, and it is at this instant that by reaction the current is produced. This effect is still farther increased by the passage before the inductive poles of numerous threads of wire wound around the armature. The current thus produced passes, by means of the commutator and brushes, around the

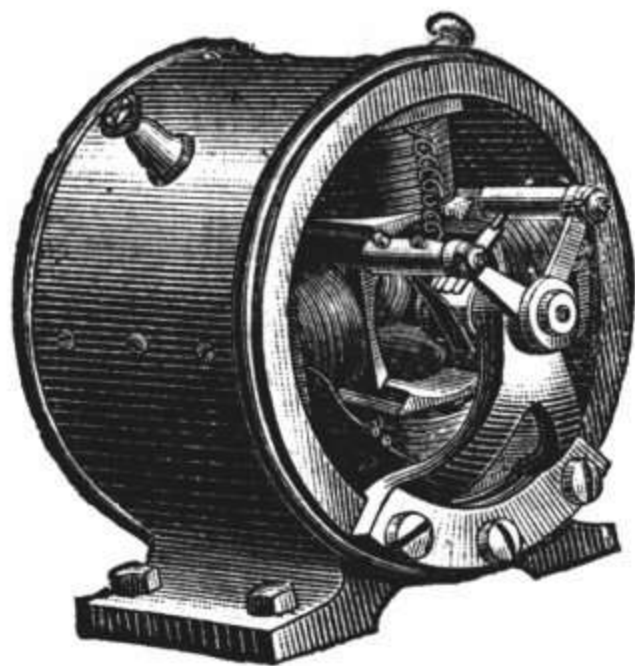

No. 2.

field magnets, which it magnetizes, and then arrives at the terminals, where are fixed the conductors of the exterior circuit of the machine. Notwithstanding its small proportions, this little machine gives surprising results and produces a current sufficient to illustrate many beautiful and interesting experiments in the department of electro-dynamics. It can be used for the decomposition of water and of salts and for electro-plating (gold, silver, and nickel). By it also the famous experiments of Ampère, showing the influence of magnets on currents and of currents on each other, can be very easily illustrated; solénoïdes and very powerful electro-magnets actuated; the remarkable phenomena, discovered by Faraday, relative to induction produced; force carried to a distance by attaching to the machine a small motor; and even, what is more extraordinary, light obtained, either arc, between two ends of fine carbons, or incandescent, with a little lamp of three-candle power. Physiological phenomena can also be shown with it, for it produces an extra current of very high tension where the exterior circuit is interrupted. We may add that it may be made to serve in the working of mines, and in numerous other ways not here mentioned it will be found very useful. This machine is made with extreme care, and is very easily kept in order, all that is necessary being to apply a drop of oil wherever there is friction, and to make the belting shorter when it stretches.

No. 2 of our catalogue is a more powerful instrument than the one just described, and gives a current equal to 10 Bunsen cells. This can be worked by steam, and is

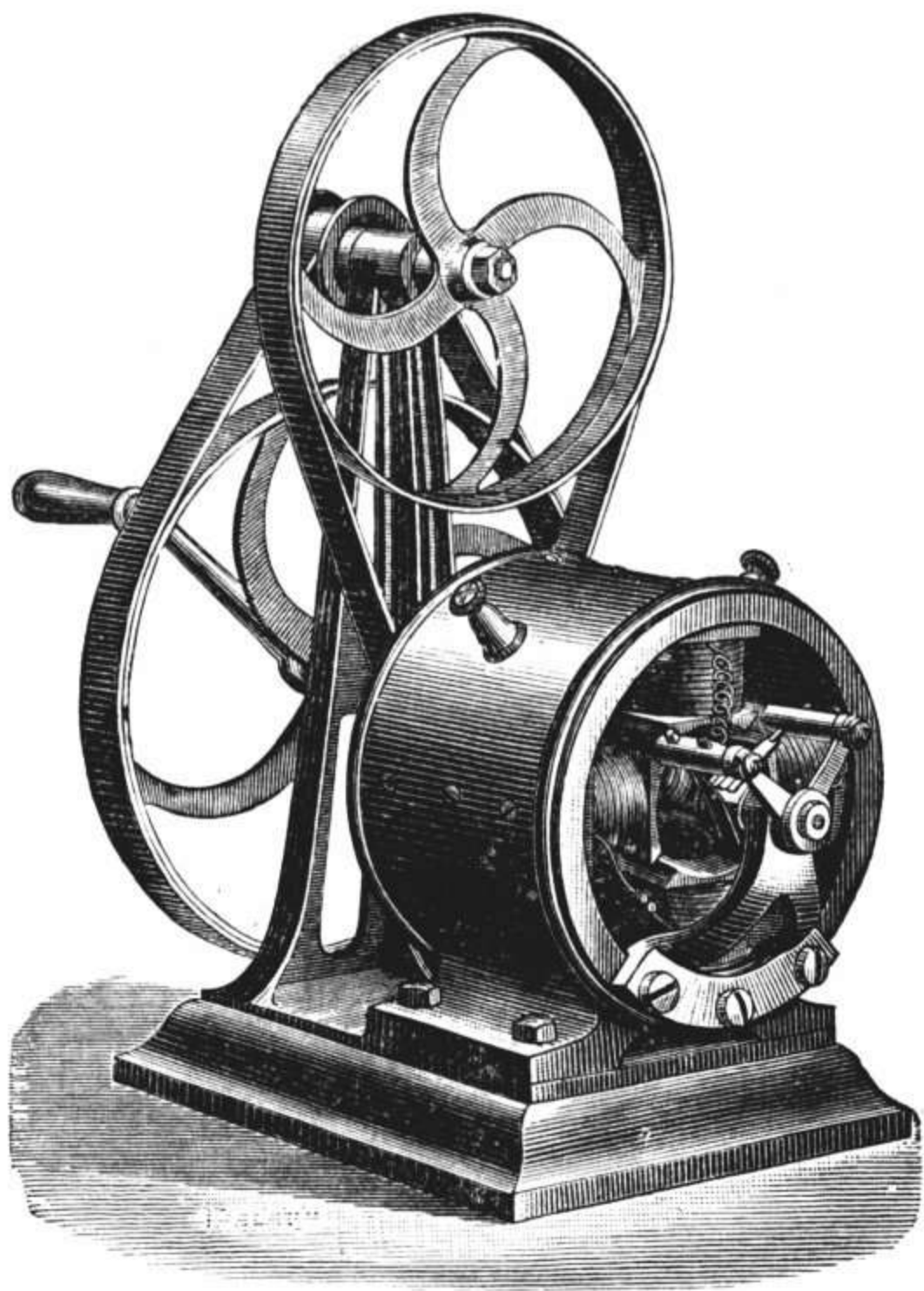

No. 2a DYNAMO-ELECTRIC MACHINE.

likewise mounted on a stand, furnished with pulleys that can be turned by hand, or, still better, on a standard of cast-iron having a treadle. In scientific or industrial laboratories it can render incalculable service, the operator always having at hand a current which he can produce at will. Having a force of from 15 to 20 kilogrammes, and a speed of from 3,000 to 5,000 revolutions, it is able to furnish a small arc light. This machine can be suitably wound for the use of electro-platers, gilders, etc.

NOTE.—To furnish the arc or incandescent light for any considerable length of time, it would be preferable to use some form of power.

6090. DYNAMO-ELECTRIC MACHINE, No. 1, with continuous current.  
School model, equivalent to 2 or 3 Bunsen cells, mounted on a mahogany base, worked by hand, Price, . . . . . \$30.00

THE DYNAMO-ELECTRIC MACHINE No. 2 gives a current equal to about 10 Bunsen cells.

This machine is arranged to be mounted on a standard, having pulleys to be turned by hand, or on a table with a fly-wheel worked by pedal, or furnished with single pulley to be run by power.



No. 2b DYNAMO-ELECTRIC MACHINE.

6091.	DYNAMO-ELECTRIC MACHINE, No. 2, alone, with pulley,	. . .	\$56.25
6092.	" " " " No. 2a, with standard and hand-gear,	. . .	75.00
6093.	" " " " No. 2b, on table, with pedal,	. . .	112.50
6094.	" " " " No. 2c, furnishes with about $\frac{1}{2}$ horse- power, a light of 6 incandescent lamps, 10 candles each; or 2 in- candescent lamps, 50 candles each; or 1 small arc light,	. . .	80.00
6095.	DYNAMO-ELECTRIC MACHINE, No. 3, with 1 horse-power, furnishes a light which is equal to about 75 Carcels,	. . .	150.00
6096.	DYNAMO-ELECTRIC MACHINE, No. 4, with 2 or 3 horse-power, gives a light equal to about 300 Carcels,	. . .	225.00

## ACCESSORIES FOR USE WITH DYNAMO MACHINES.

We give below a list of apparatus with which a number of experiments may be made with the small Dynamo Machine No. 1, or with the larger sizes. This list will hereafter be considerably increased.

### 6098. Calorific effects of the Current.

1. Double Holder, mounted upon a foot, for receiving fine carbons, platinum, wires, etc., . . . . .	\$3 00
2. Incandescent Lamp, . . . . .	2 50
3. Universal Support for Incandescent Lamp, . . . . .	1 75
4. Fusees for producing explosion in mines, per dozen, . . . . .	1 50
5. Insulated Wire for use with Fusees, 5 meters long, . . . . .	75
6. Interrupting Commutator for explosion of Fusees, . . . . .	1 75

NOTE.—In absence of this Commutator, the current will have to be broken by hand.

### 6099. Chemical effects of the Current.

21. Voltmeter for the decomposition of water, . . . . .	2 50
22. Electric Plating, small glass vessel for, . . . . .	1 75
23. Gold and Silver Plating, small glass vessel for, platinum anode, . . . . .	2 50
24. Nickel Plating, small vessel for, platinum anode, . . . . .	2 50
25. Gold Bath, 125 cm. cubes in a flask with emery stopper, . . . . .	1 00
26. Silver Bath, 125 cm. cubes in a flask with emery stopper, . . . . .	75
27. Nickel Bath, 125 cm. cubes in a flask with emery stopper, . . . . .	50
28. Small Accumulator, . . . . .	2 50

### 6100. Magnetic effects of the Current.

41. Small Galvanometer, . . . . .	2 50
42. Galvanometer showing intensity and electro-motive force of the current, . . . . .	10 00
43. Solénoïde, for holding in the hand, with movable soft-iron core for changing into a straight electro-magnet, . . . . .	6 00
44. Rotating Solénoïde, having movable soft-iron core for transforming into movable electro-magnet, . . . . .	
45. Ampère's Frame, for holding in the hand, . . . . .	
46. Movable Ampère's Frame, . . . . .	
47. Universal Support, with agate cap, to hold the movable Solénoïde, . . . . .	
48. Electro-magnet, mounted on a foot, with soft-iron armature, . . . . .	4 00
49. Inverting Commutator, to change the direction of the current, . . . . .	
50. Bar Magnet, in case, with armature, . . . . .	

### 6101. Mechanical effects of the Current.

81. Small Electric-motor, . . . . .	
82. Electric Bell, mounted on a foot, . . . . .	

### 6102. Physiological effects of the Current.

101. Nickel-plated Electrodes, for medical use, . . . . .	1 25
102. Double Insulated Wire, pliable, two colors, . . . . .	50

### 6103. Induction.

121. Induction Coil of Faraday, giving primary and secondary currents, . . . . .	
122. Ruhmkorff's Induction Coil, . . . . .	
123. Geissler Tubes, . . . . .	

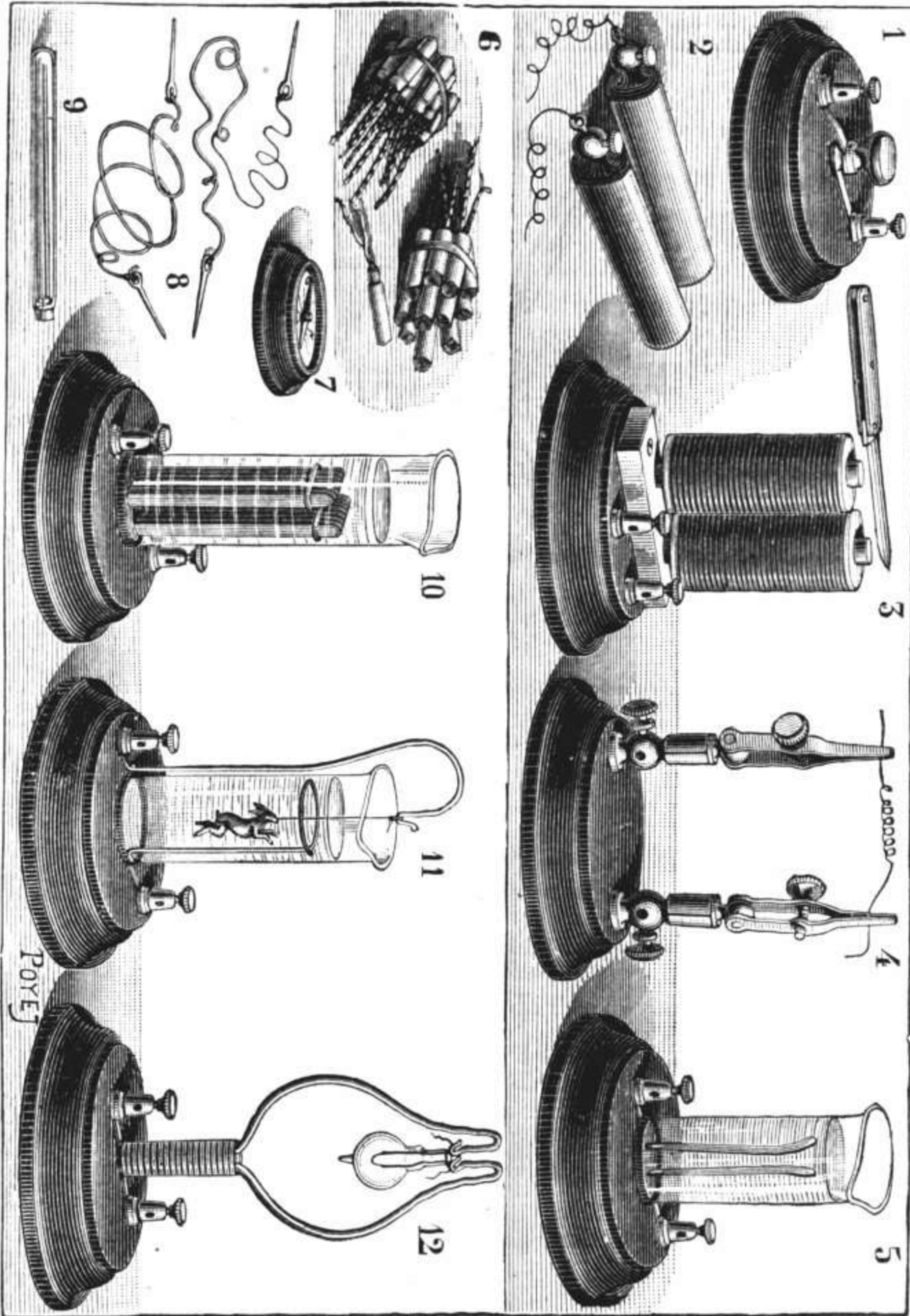

ACCESSORIES FOR USE WITH DYNAMO MACHINES.

DYNAMO-ELECTRIC MACHINES,  
FOR SMALL INSTALLATIONS AND FOR LABORATORY USE.

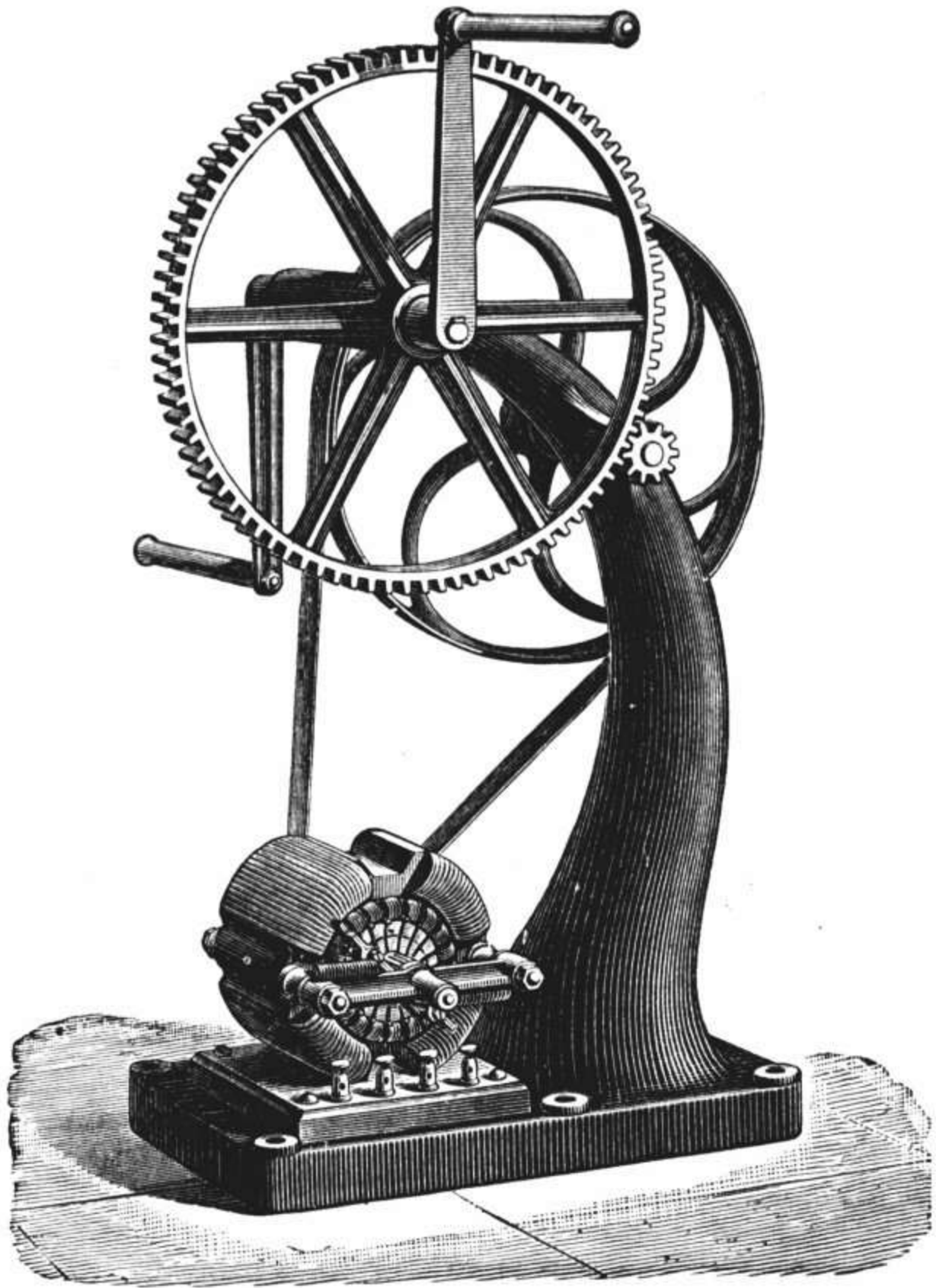

Nos. 6 AND 7.

We desire to call attention to a new Dynamo Machine, by means of which all the laws of Electro-Dynamics may be illustrated, and all experiments pertaining to a full course of electricity may be made. This small instrument, operated by hand, will furnish a light equivalent to 35 Bunsen elements, with an electro-motive force of



1 volt. 90 each, and a resistance of 0 ohm 06. As it is very light and occupies only a small space, it can readily be used in any laboratory, however small. The price of it is less than that of any other apparatus of its class; it is cheaper even than those which are much less powerful. There is real economy in furnishing a physical laboratory with an instrument of this kind. It dispenses with the use of acids and consumption of zinc and the necessity of tedious preparations and costly experiments. This machine is always ready for use, and the pupils themselves will easily be able to furnish the necessary motive power for small experiments, and thus their interest will be all the more assured.

This machine, when run by power, will furnish an arc light of sufficient intensity for optical projections of all kinds, and will run from four to six incandescent lamps.

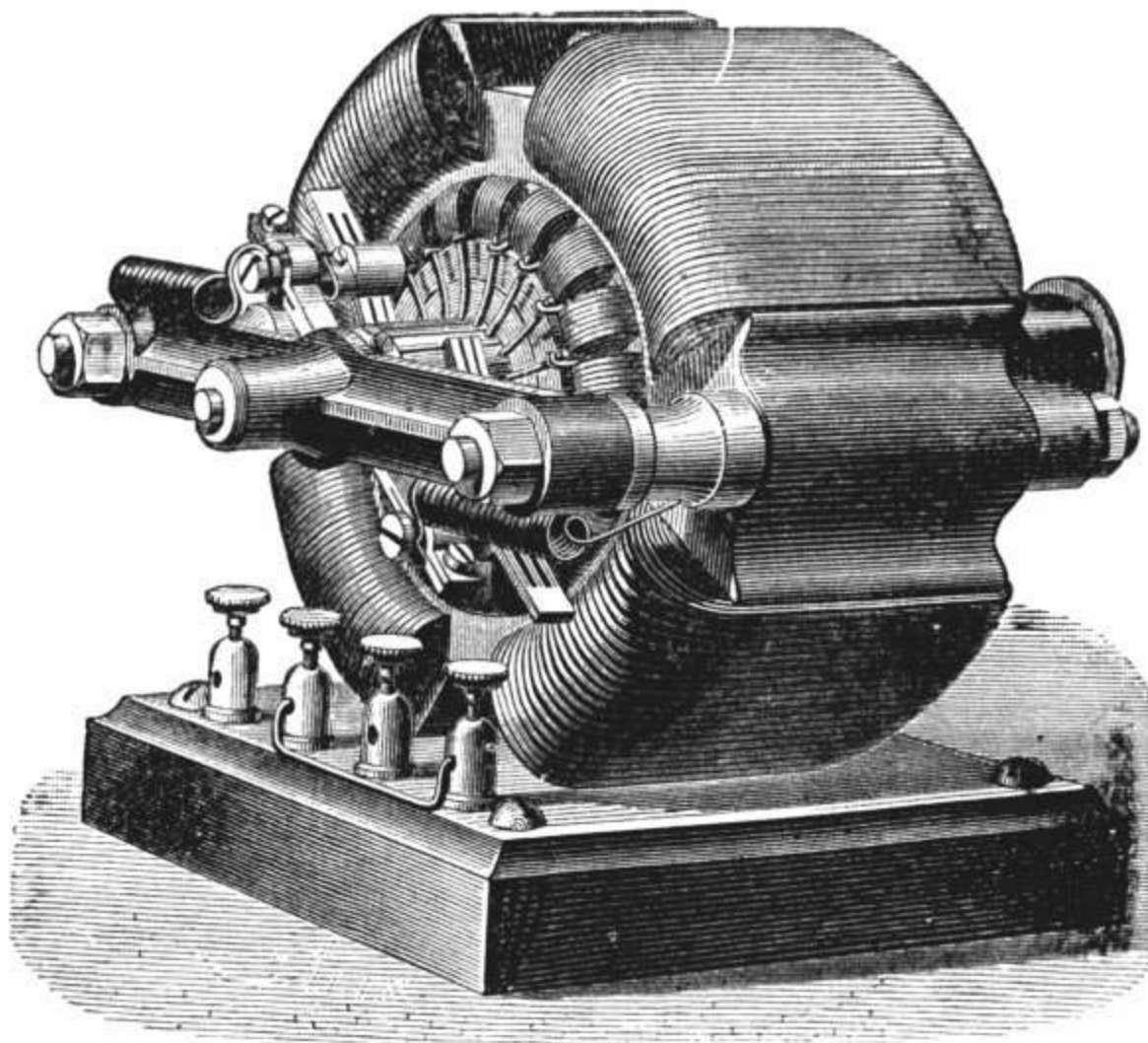

Nos. 8 TO 13 DYNAMO-ELECTRIC MACHINE.

- |   |          |
|---|----------|
| 6110. DYNAMO MACHINE, No. 6, will give an arc light equal to about 80 Carcels, or will work 5 Swan lamps of 50 Ohms resistance. Machine complete, with multiplying gear, to be worked by two men, and mounted on a base of handsome design, . . . . .   | \$250.00 |
| 6111. DYNAMO-ELECTRIC MACHINE, No. 7, similar to No. 6, but modified for quantity and intensity, with extra interchangeable armature. This arrangement renders the machine more complete for general experimental purposes; the armature, with fine wire, will produce a brilliant electric light, and the coarse wire armature is used for electro-plating, decomposing salts, heating wires, etc.<br>Price, complete, . . . . . | 300.00   |
| 6112. DYNAMO MACHINE, No. 8, same as No. 6, without gearing, for use by hand, but with pulley for use with steam, . . . . .   | 150.00   |
| 6113. DYNAMO MACHINE, No. 9, similar to No. 7, . . . . .  | 200.00   |
| 6114. DYNAMO MACHINE, No. 10, similar to No. 8, but modified for electro-plating, . . . . .   | 170.00   |
| 6115. DYNAMO MACHINE, No. 11, similar to No. 8, modified for secondary batteries, . . . . .   | 150.00   |

6116. DYNAMO MACHINE, No. 12, similar to No. 8, gives a light equal to 350  
Carcels, requires about 2 horse-power, and will feed 15 Swan lamps, \$325.00
6117. DYNAMO MACHINE, No. 13, similar to No. 8, gives a light equal to 650  
Carcels, requires about 4½ horse-power, and will feed 2 Swan lamps, 540.00

### PERFORMANCE OF MACHINES Nos. 6 and 8.

We call attention to these results as exceedingly good for size of machines, and showing all necessary power for laboratory use.

This machine has the field connected in derivation.

Resistance of field, 60 ohms.      Resistance of armature, 1.45 ohms.

With a speed of 3,000 turns per minute on an arc lamp it gives a current of 7.5 amperes and an electro-motive force of 50 volts.

By placing in the circuit a sufficient resistance (as an Edison lamp) the current is reduced to about one ampere, but the electro-motive force is increased to 110 volts.

With field connected in derivation, it is necessary to have some resistance in the exterior circuit. An inch of platinum wire No. 24 between the poles of the machine is not affected, while a foot or more of the same wire is raised to incandescence.

We would recommend Dynamo Machines Nos. 6 and 7 as being especially adapted to the wants of schools and colleges, being constructed to meet the wants of scientific men, which the ordinary dynamo machines are not.

*Cases and Packing extra on all machines.*

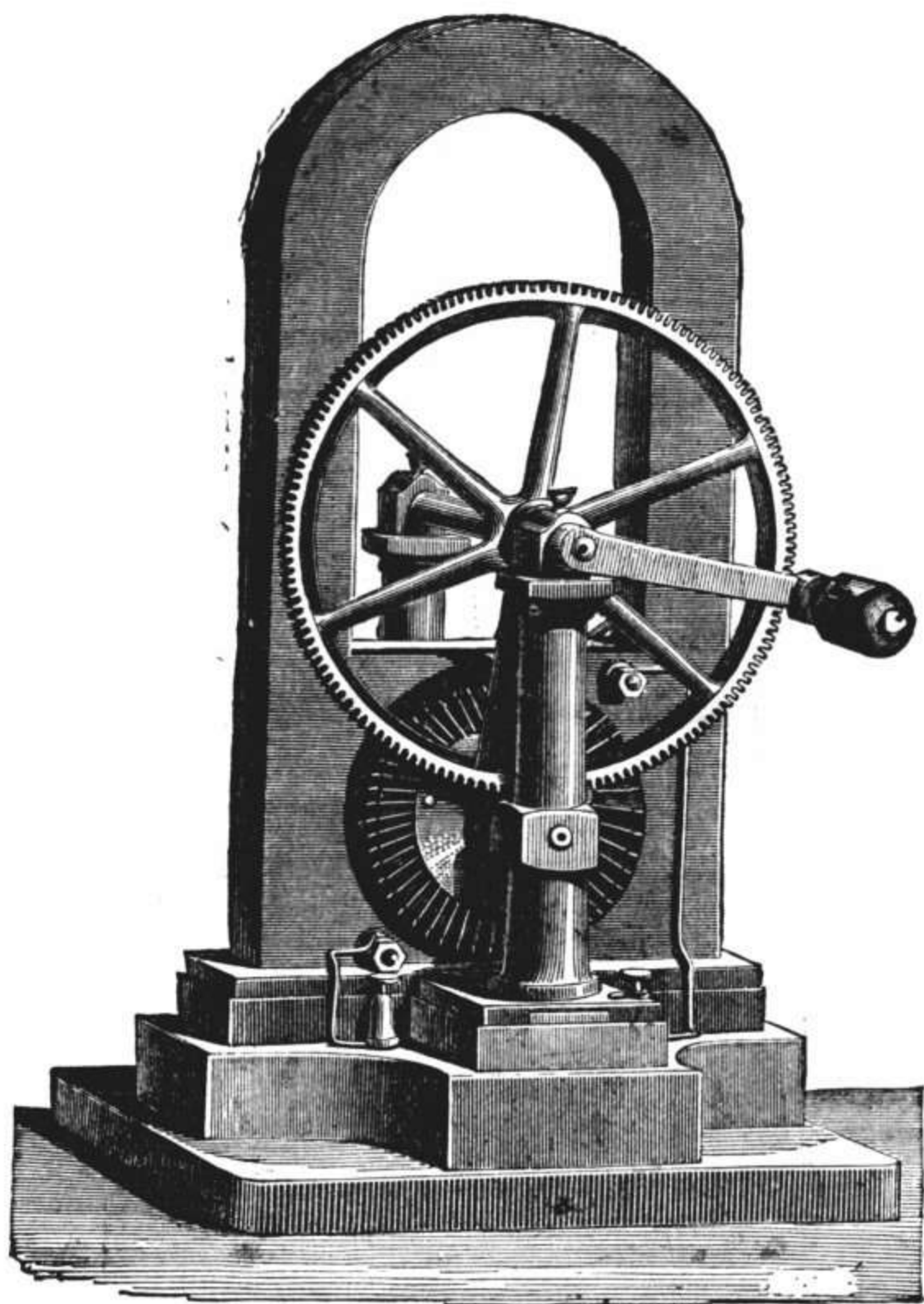

No. 16 GRAMME MAGNETO-ELECTRIC MACHINE.

We append a list of Gramme Machines, which, from the important part they performed in the practical introduction of electricity, are now classic.

These machines are very valuable for illustration, but the machines previously described are cheaper for the same power and equally good.

A series of steel plates, which are separately magnetized and then connected, constitutes the powerful magnets of this machine. The revolving armature is the well-known Gramme ring, which is of iron, with coils of wire wound round it tangentially. With this revolves a commutator, which gives a continuous electrical current. The following results may be accomplished with this machine: A platinum wire  $\frac{3}{10}$  mm. in diameter and 6 cm. long can be heated to redness, water decomposed, and, in short, its effects are the same as those obtained with two or three Bunsen elements.

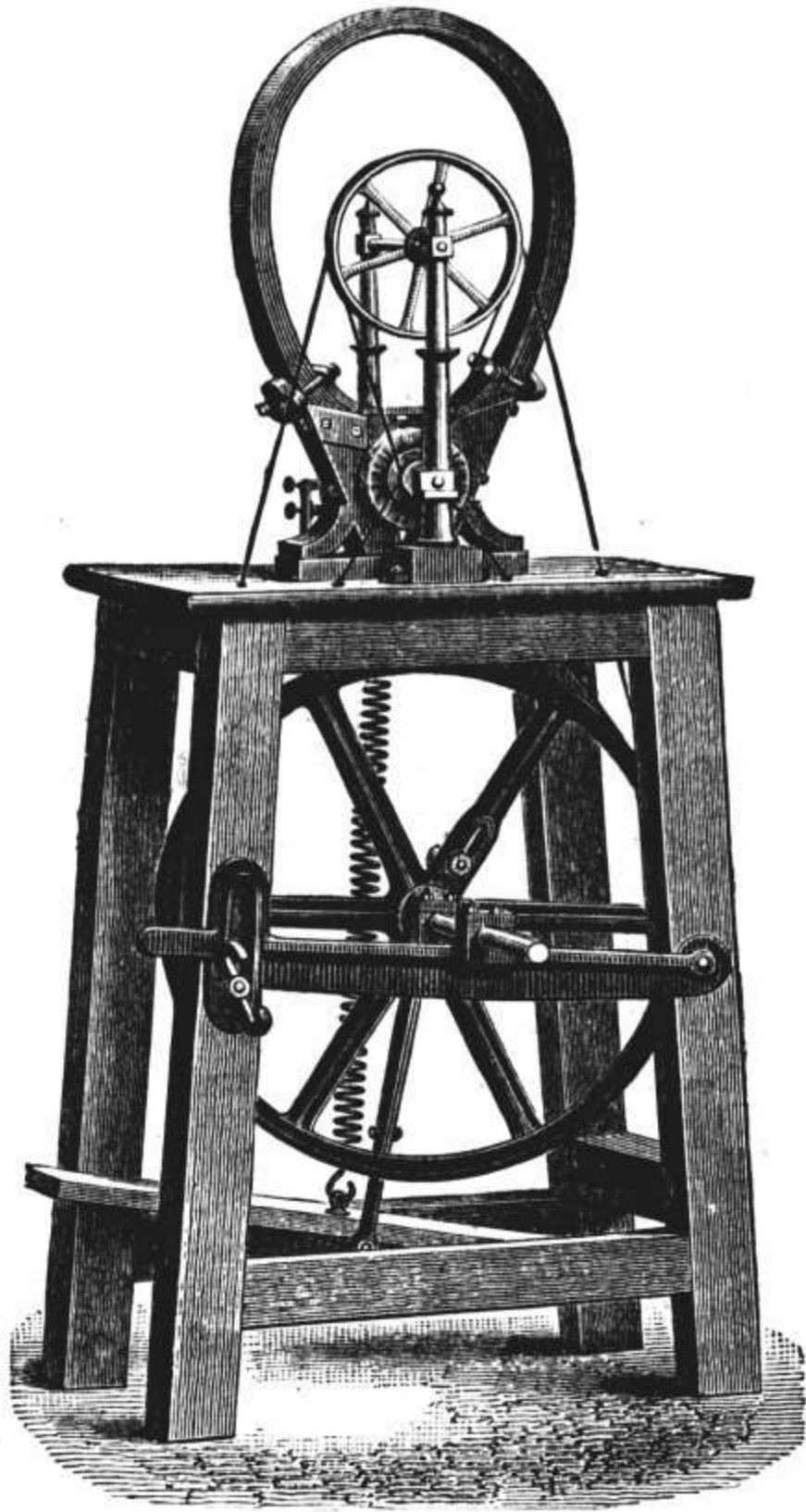

No. 17 GRAMME MAGNETO-ELECTRIC MACHINE.

6118. GRAMME MAGNETO-ELECTRIC MACHINE, No. 16, with crank and multiplying gear. All the experiments pertaining to a course in physics may be shown with this machine, with the exception of voltaic arc light. Two armatures are necessary with it, one of coarse wire for quantity, and one of fine wire for intensity, some experiments being more successful with the one, and some with the other. This is a larger and more powerful machine than the one just described, although resembling it closely. It is equal to about 10 cells of Bunsen's Battery, and is very convenient for laboratory use, being easily moved and worked. Price on application.

6119. GRAMME MAGNETO-ELECTRIC MACHINE, No. 17, with belts.

6120. TABLE, No. 17a, with pedal and driving-wheel for above.

Prices on application.

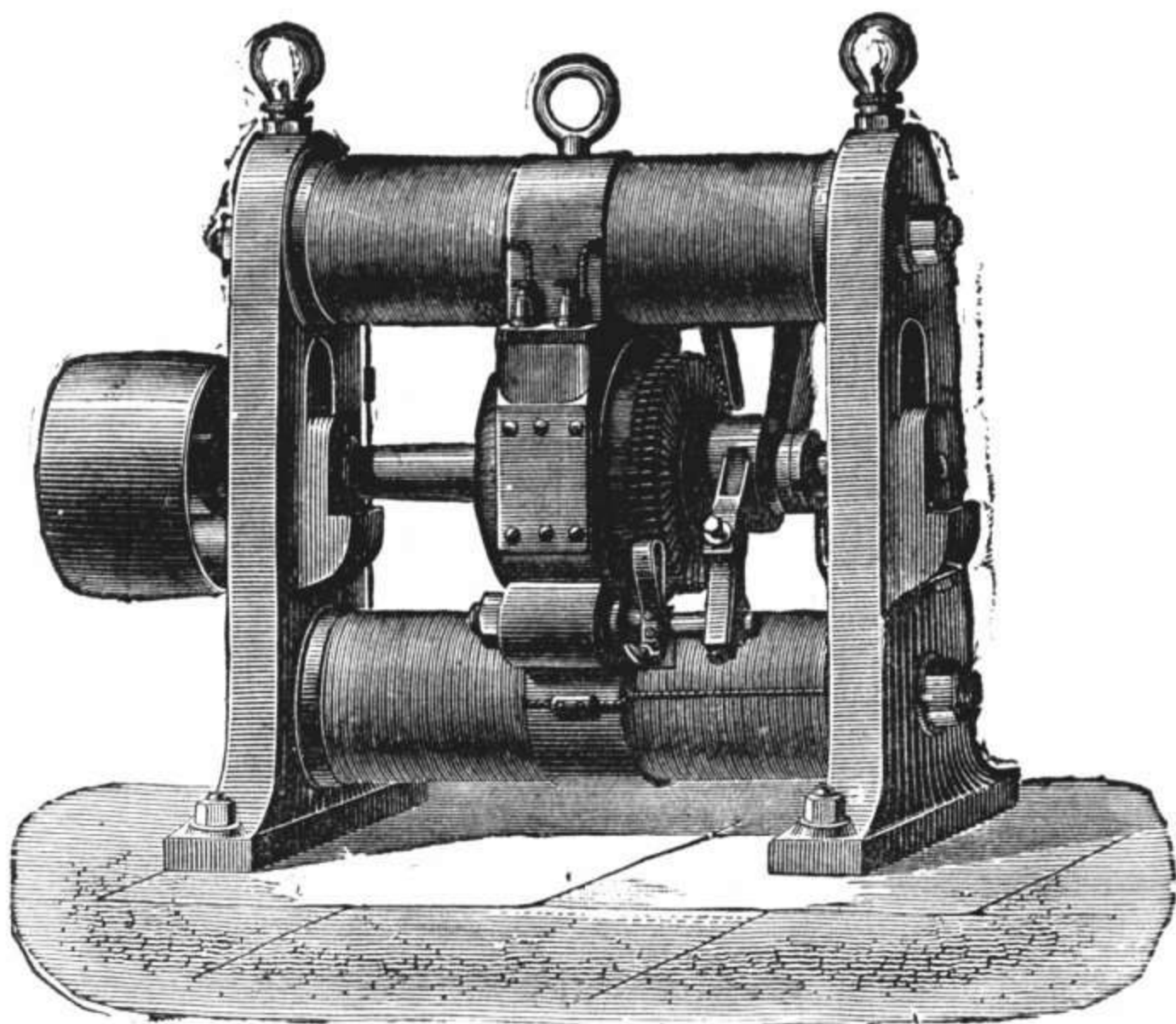

GRAMME MACHINE, TYPE A.

6221. Gramme Dynamo-Electric Machine, Type A, for industrial and scientific purposes. All sizes furnished.

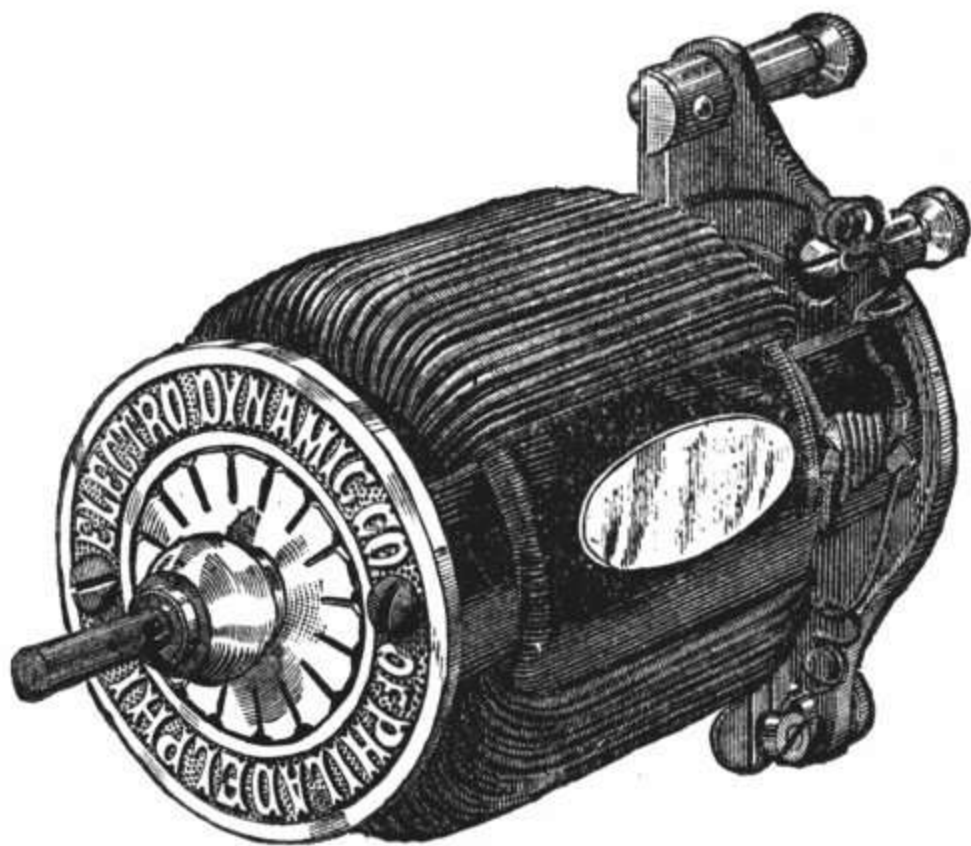

6225.

6225. **Patent Double Induction Motor**, for general Laboratory use.

Packed for shipment, . . . . . \$15 25  
 Battery to run same (see page 96, Part 4) packed for shipment, . . . . . 16 00

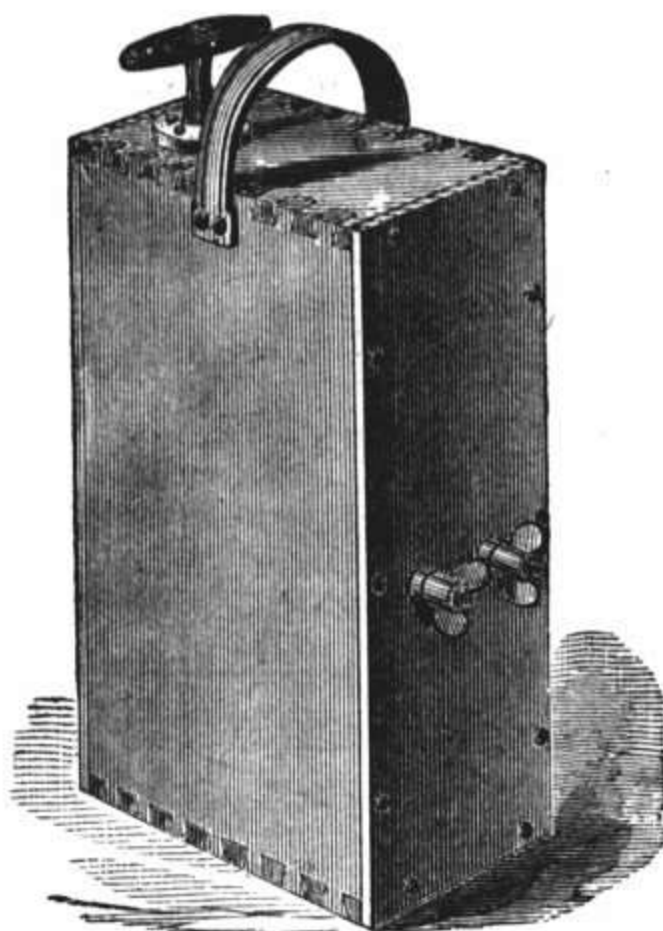

6226 and 6227.

6226. **Magneto-Electric Blasting Machine, No. 3.** . . . . \$25 00  
 6227. **Magneto-Electric Blasting Machine, No. 4 (larger),** . . . . 50 00



6228.

6228. **Platinum Fuzes**, cotton covered (for use with Magneto-Electric Machine).

4 feet wires,	\$0 03 $\frac{3}{4}$ each.	12 feet wires,	\$0 06 $\frac{3}{4}$ each.
6 " "	04 $\frac{1}{2}$ "	14 " "	07 $\frac{1}{2}$ "
8 " "	05 $\frac{1}{4}$ "	15 " "	08 $\frac{3}{4}$ "
10 " "	06 " "	16 " "	09 $\frac{2}{10}$ "

Fuzes with longer wires at the rate of  $\frac{4}{10}$  of one cent per foot additional.

**Gutta-Percha Covered Fuzes.**

N. B.—The price of Gutta-Percha Wire having greatly advanced, the price of these Fuzes will hereafter be as follows :

4 feet wire,	\$0 20 each.
6 " "	29 "
8 " "	38 "

Fuzes with Gutta-Percha Covered Wires will be made to order only.

GAS ENGINE FOR RUNNING DYNAMOS.

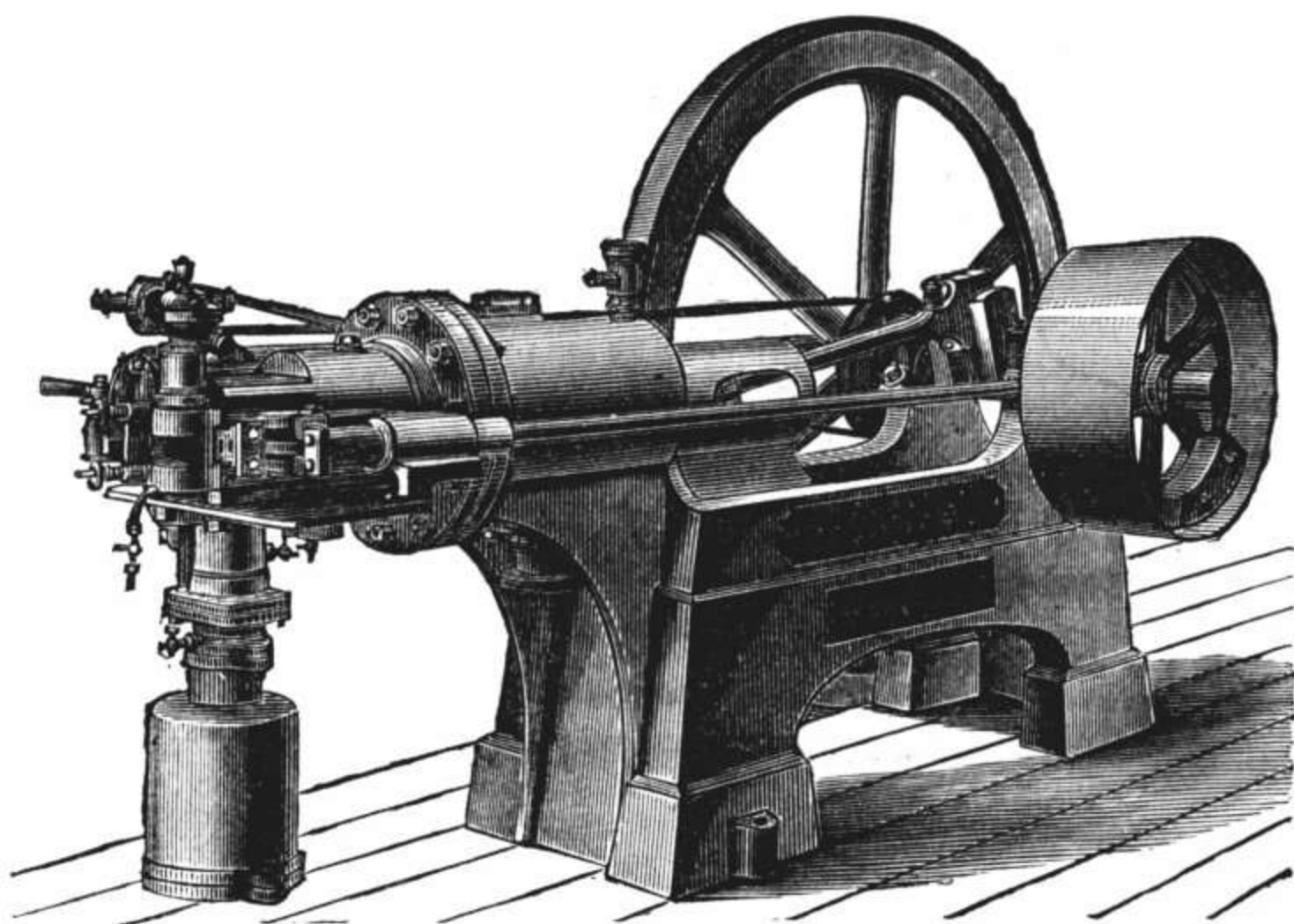

CLERK'S NEW GAS ENGINE.

6230. **Clerk's New Gas Engine**, for running Dynamo-electric Machines, water motors, steam engines, and all forms of power necessary for electric light purposes; also accompanying pulleys, belts, and attachments required for putting up the same.

Prices on application.

6235. **Shipman Petroleum Engine, No. 1.** Weighing about 50 lbs.; occupying a space 11 inches wide, 12 high, and 18 long,  $\frac{1}{3}$  horse-power, . . . . . \$100 00

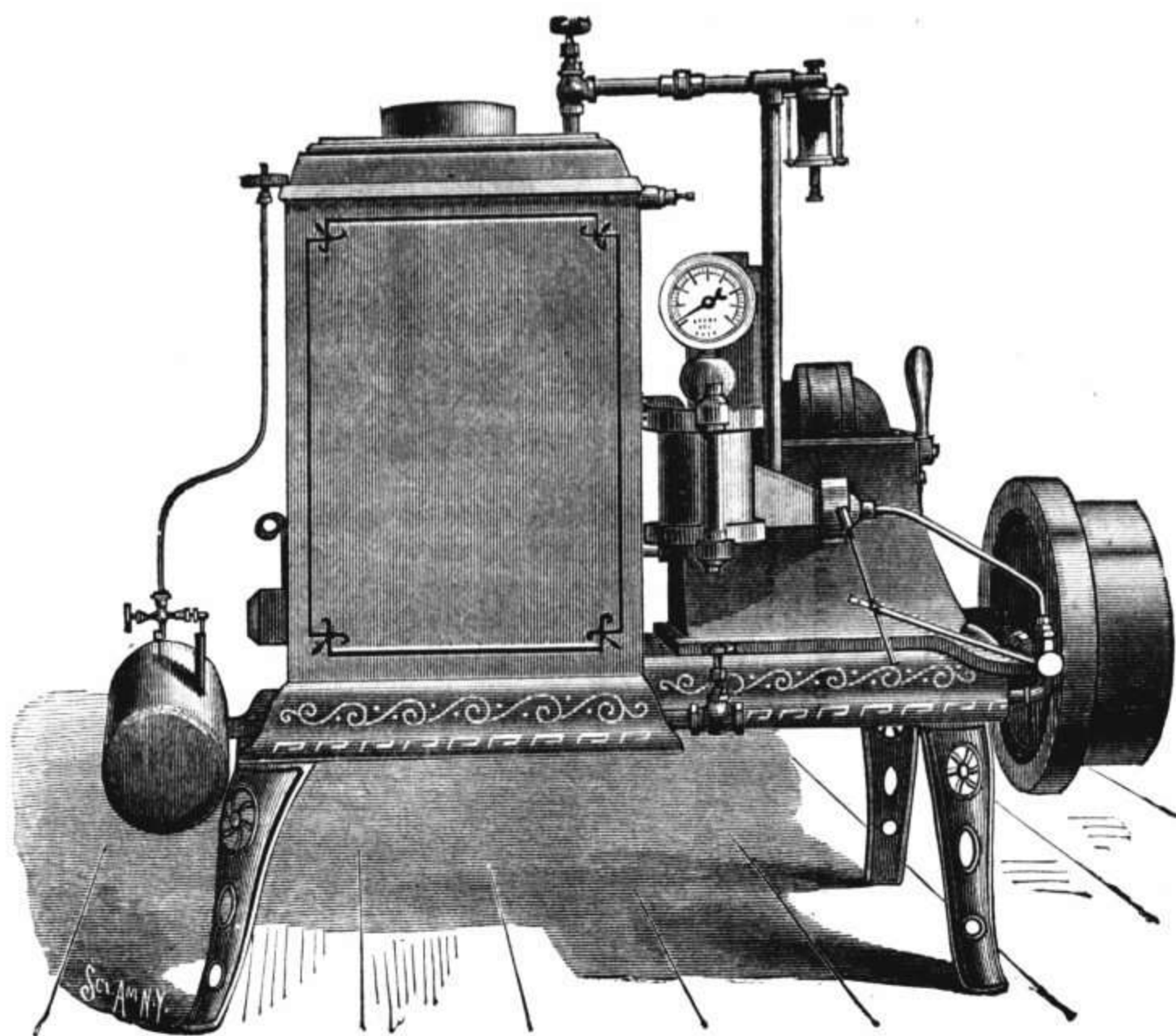

SHIPMAN PETROLEUM ENGINE.

6236. **Shipman Petroleum Engine, No. 2.** Cylinder, 2x3 inches; revolutions, 400 to 600; pressure carried, 100 lbs.; total weight, about 200 lbs., 1 horse-power, . . . . . \$125 00
6237. **Shipman Petroleum Engine, No. 3.** Cylinder, 3 in. bore, 4 in. stroke; occupying space of about 2x3½x2 ft.; weight, about 500 lbs., 2 horse-power, . . . . . 175 00



SECTION VIII.—THE GALVANOMETER AND ELECTRICAL MEASUREMENT.

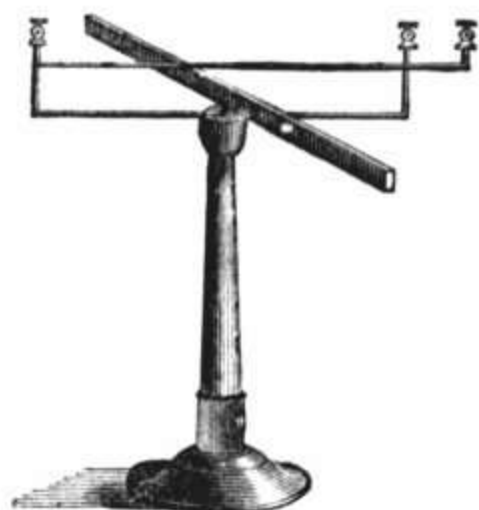

6240 and 6241.

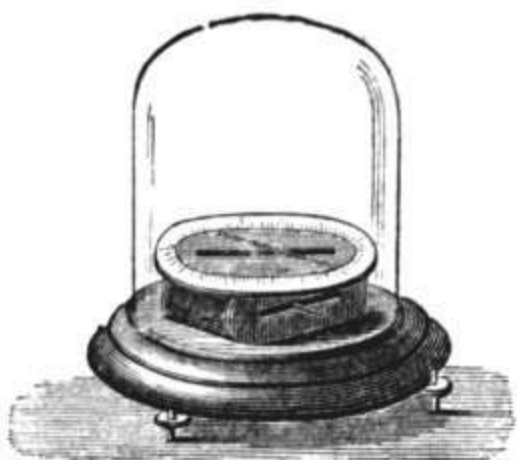

6243.

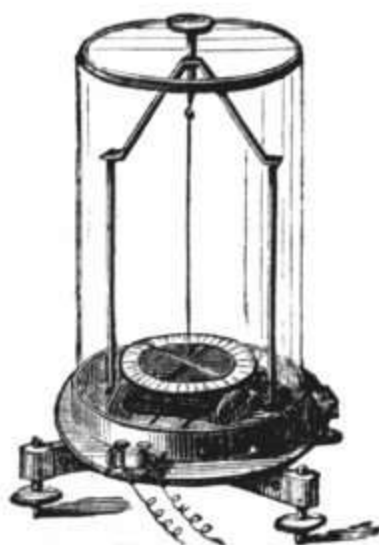

6244 and 6245.

- |   |        |
|---|--------|
| 6240. Apparatus to Illustrate Oersted's Law. Magnet eight inches long, . . . . .  | \$4 00 |
| 6241. Apparatus to Illustrate Oersted's Law. Magnet fifteen inches long, .  | 7 00   |
| 6242. Galvanometer. Simple form, with single needle suspended upon a needle point at centre, . . . . .  | 5 00   |
| 6243. Galvanometer, with astatic needle; on rosewood base, with leveling screws, graduated circle, and glass cover, . . . . .   | 15 00  |
| 6244. Galvanometer. Similar to No. 6243, but with posts to suspend the needle by a filament of unspun silk, an adjustment for placing the zero of the scale in the axis of the coil, and leveling screws, . . . | 20 00  |
| 6245. Galvanometer. Similar to No. 6243, but with helix for use in thermoelectric experiments, . . . . .  | 20 00  |

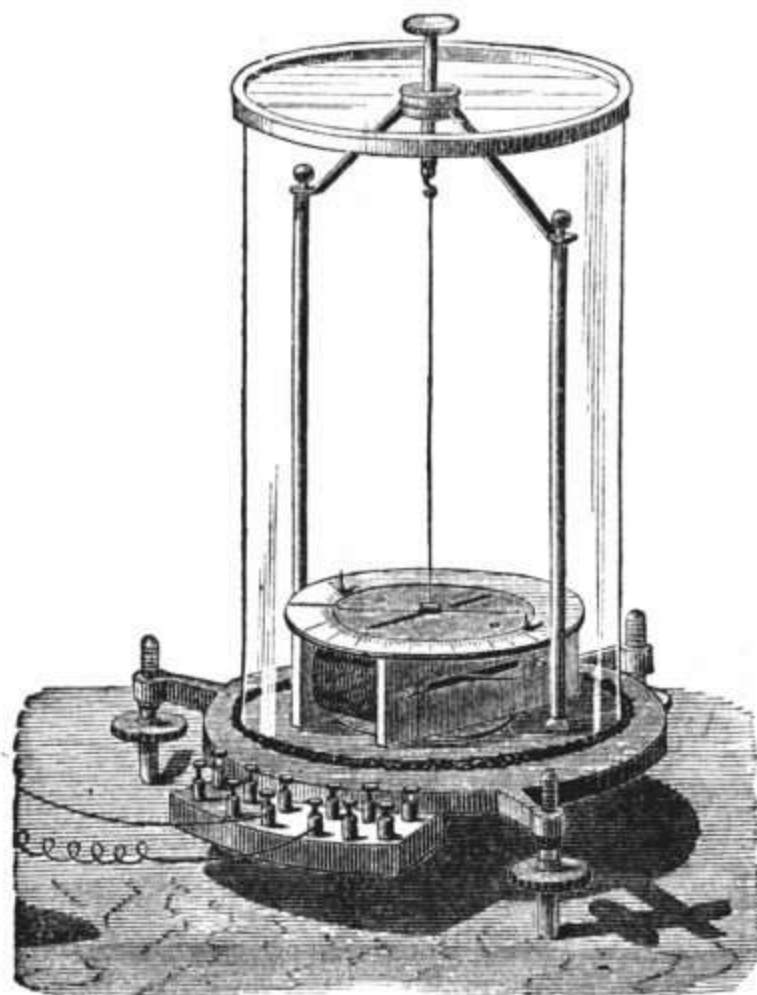

6247.

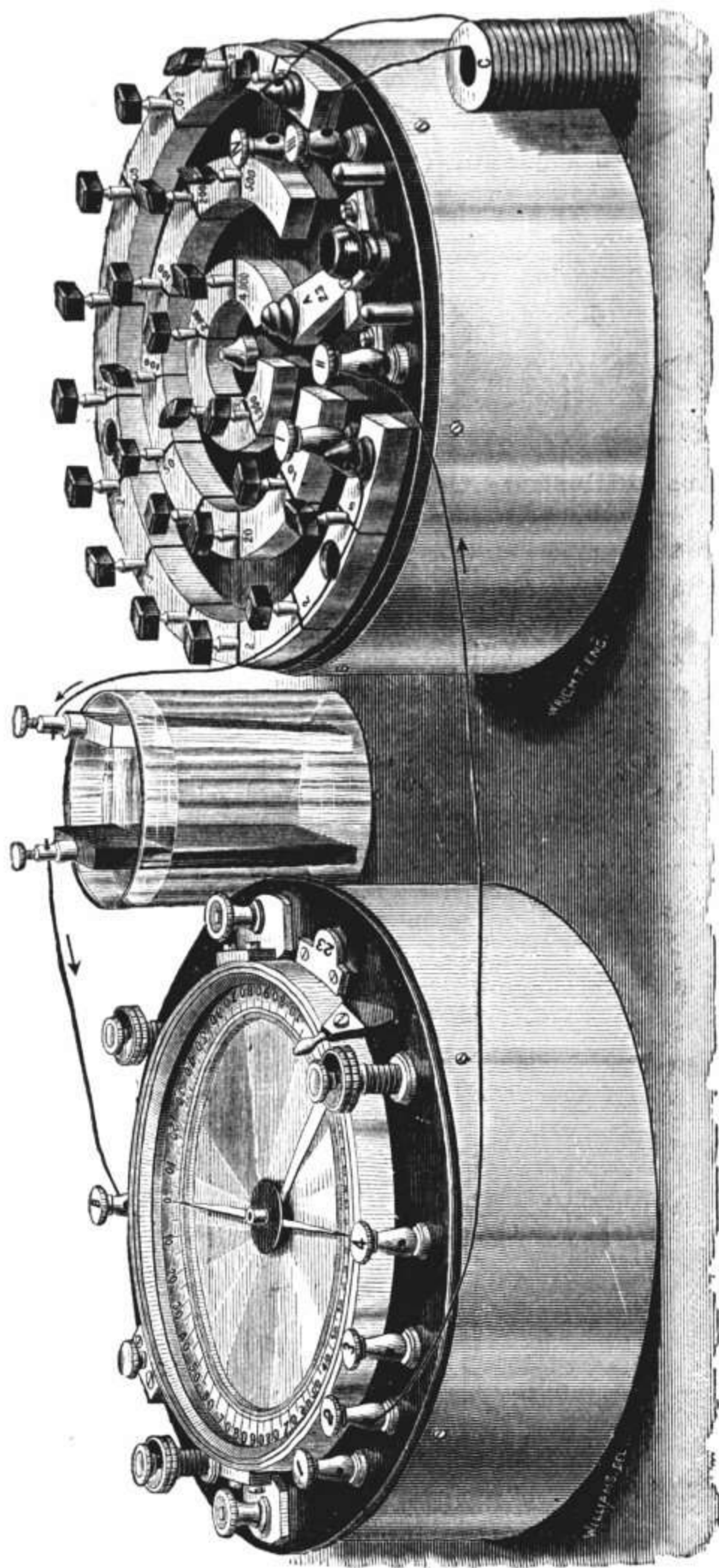

No. 6256.

	PRICE.
6246. <b>Differential Galvanometer.</b> For testing the resistance of batteries, wires, etc., etc. On mahogany leveling stand, with glass cover. Needles suspended by fibre of unspun silk, . . . . .	\$25 00
6247. <b>Queen's Universal Galvanometer.</b> Rosewood base, with leveling screws, astatic needles, suspended from brass arm by a fibre of unspun silk, with arrangement for adjusting the zero of the scale to the axis of the coils. Convertible by a moment's adjustment, from an ordinary <i>quantity</i> galvanometer, into one for <i>intensity</i> , or into a differential galvanometer for either <i>intensity</i> or <i>quantity</i> , . . . . .	50 00
6248. <b>Small Light Mirror.</b> With wire mounting, to be attached to either of Nos. 6244, 6245, or 6247, for use in projection, . . . . .	1 00
6249. <b>Tangent Galvanometer.</b> Single ring, . . . . .	30 00
6250. <b>Copy of a British Association Unit,</b> or Ohm, as issued by the Committee, . . . . .	30 00
6251. <b>Bradley's Tangent Galvanometer,</b> with three coils, Nos. 2, 3, and 4, . . . . .	50 00
6252. <b>Bradley's Tangent Galvanometer,</b> with four coils, Nos. 1, 2, 3, and 4, . . . . .	85 00
6253. <b>Bradley's Rheostat,</b> with resistance from $\frac{1}{100}$ of an Ohm to 2,111 Ohms, . . . . .	75 00
6254. <b>Bradley's Rheostat,</b> with resistance from $\frac{1}{100}$ of an Ohm to 10,111 Ohms, . . . . .	135 00
6255. <b>Bradley's Complete Apparatus for Electric Measurement,</b> consisting of Tangent Galvanometer, No. 6251 and Rheostat No. 6253, . . . . .	125 00
6256. <b>Bradley's Complete Apparatus for Electric Measurement,</b> consisting of Tangent Galvanometer No. 6252 and Rheostat No. 6254, . . . . .	220 00

The instruments Nos. 6251 to 6256 are intended for accurately determining the electro-motive force, resistance and strength of batteries, and resistance of conductors; for locating faults, breaks, and crosses on telegraph lines or cables; for measuring the amount of any metal deposited in a given time in electro-plating; and for determining the specific conductivity of metals.

The Coil No. 1 of 6252 is for currents of high intensity, No. 4 for those of great quantity, Nos. 2 and 3 for intermediate currents.

SECTION IX.—OF INSTRUMENTS ILLUSTRATING THE HEATING EFFECTS OF DYNAMICAL ELECTRICITY.

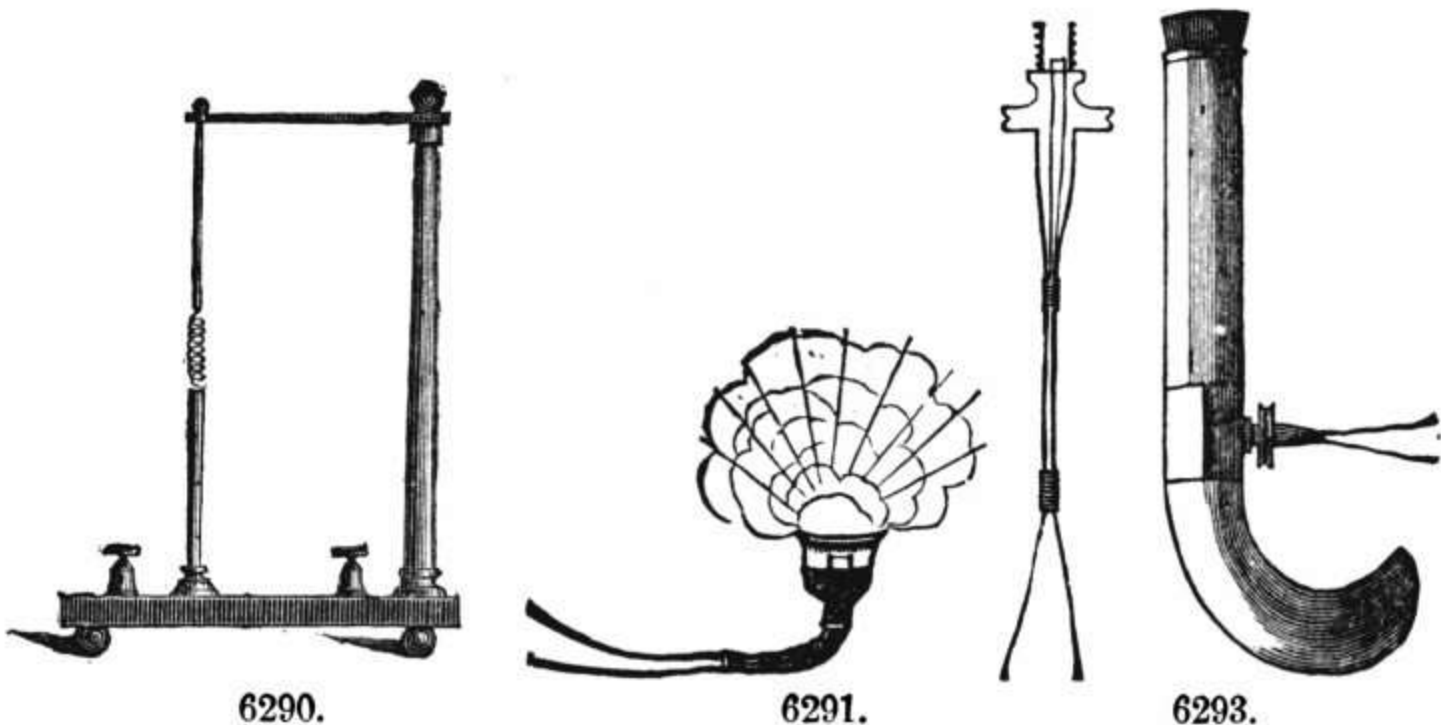

6290. <b>Galvanic Lamp.</b> Of platinum wire in coil, with vertical support of brass, on a neat polished base of mahogany, . . . . .	\$5 00
--	--------

DYNAMICAL ELECTRICITY.

- 6291. **Powder Cup.** Of brass, with platinum wire in coil, . . . . . 1 00
- 6292. **Powder Cup.** Of brass, with handle of wood, and an extra supply  
of platinum wire, . . . . . 4 00
- 6293. **Voltaic Pistol.** Of brass, strongly made and neatly finished, . . . . . 5 00

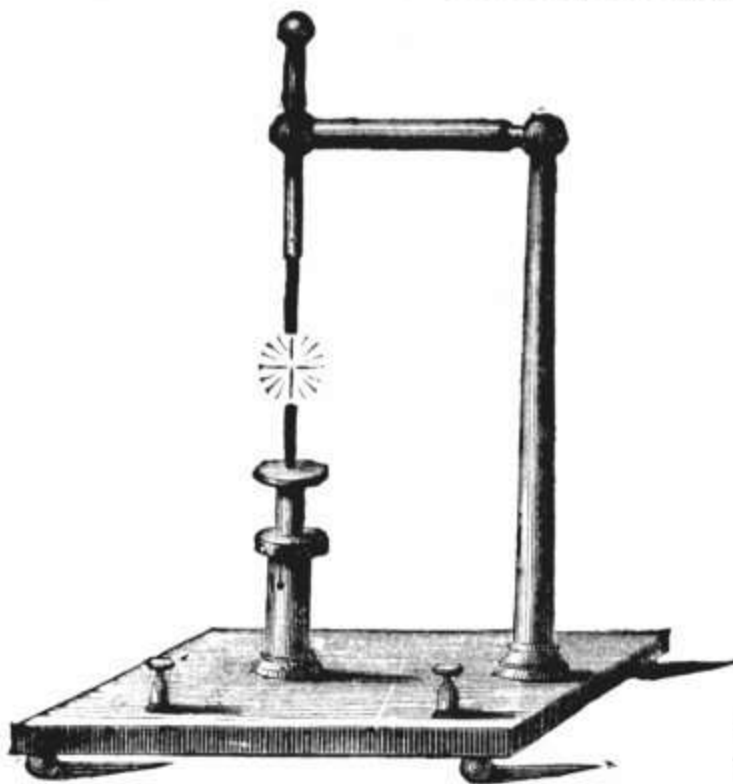

6301.

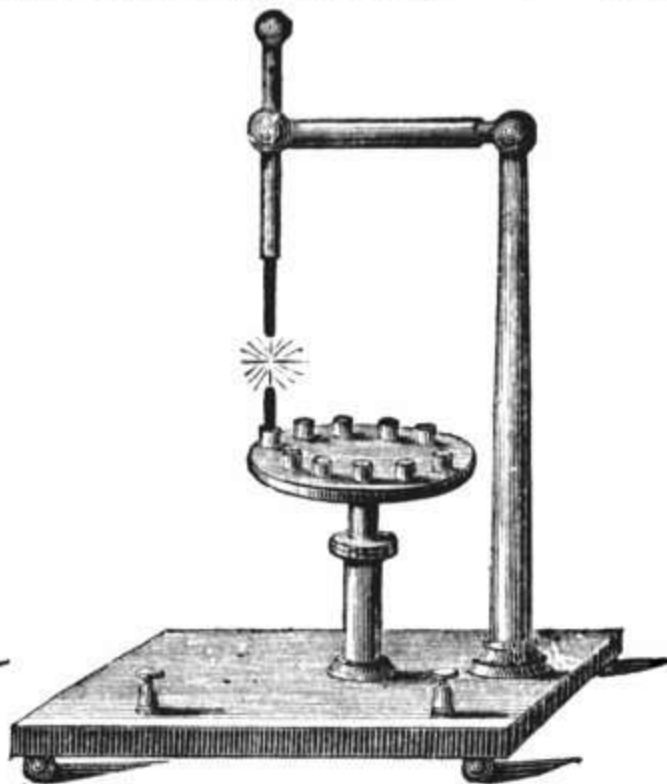

6302.

- 6300. **Simple Electric Lamp.** Base of wood, arms and holders of brass, \$8 00
- 6301. **Simple Electric Lamp.** Base of hard rubber, post, arm, and carbon  
holders of brass, . . . . . 12 50

For complete list of Electrical Lamps, see Part 4.

6302. COMPOUND ELECTRIC LAMP. For use in projection of spectra. Base of hard rubber, post, arm, and metal holders of brass. The lower holder consists of a disk of brass with cups for ten different substances, which can be thus rapidly brought in succession into circuit and volatilized, . . . . . \$20.00
6303. COMPOUND ELECTRIC LAMP. Similar to No. 6302. but with a second disk holding 10 carbons, instead of the single upper carbon holder of 5581. The metals can thus be quickly volatilized without mixture of their spectra, . . . . . 30.00

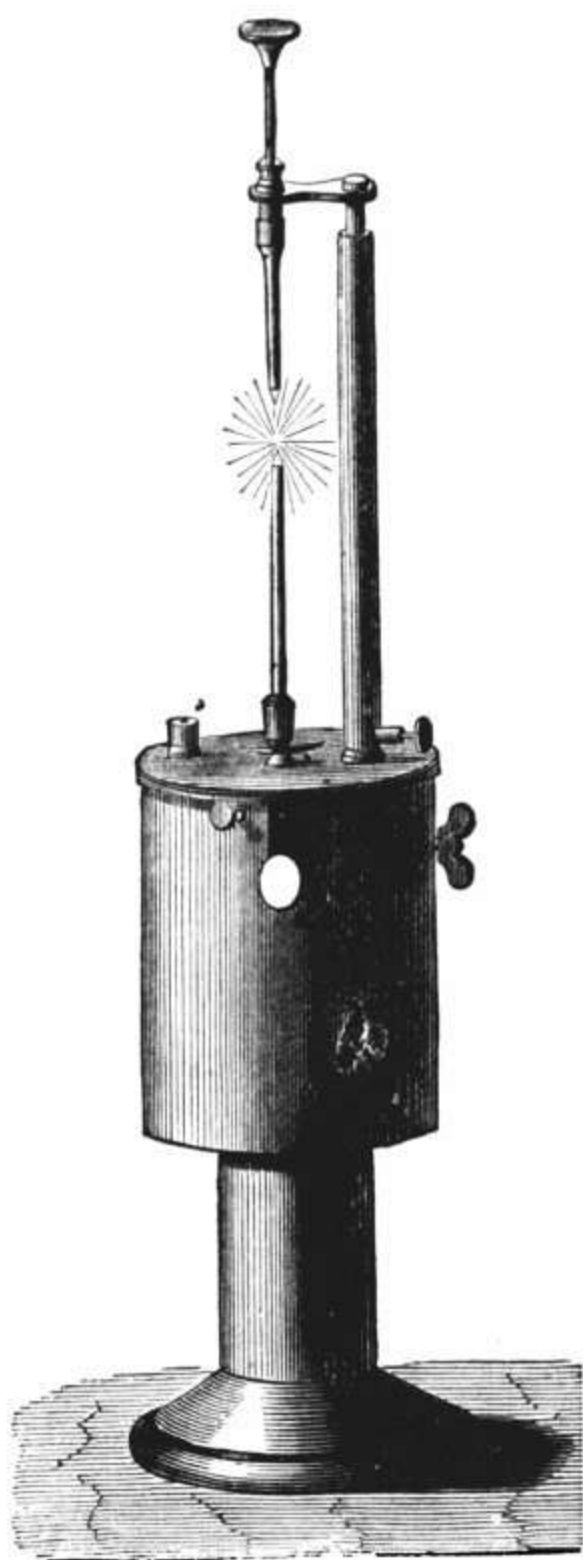

6307.

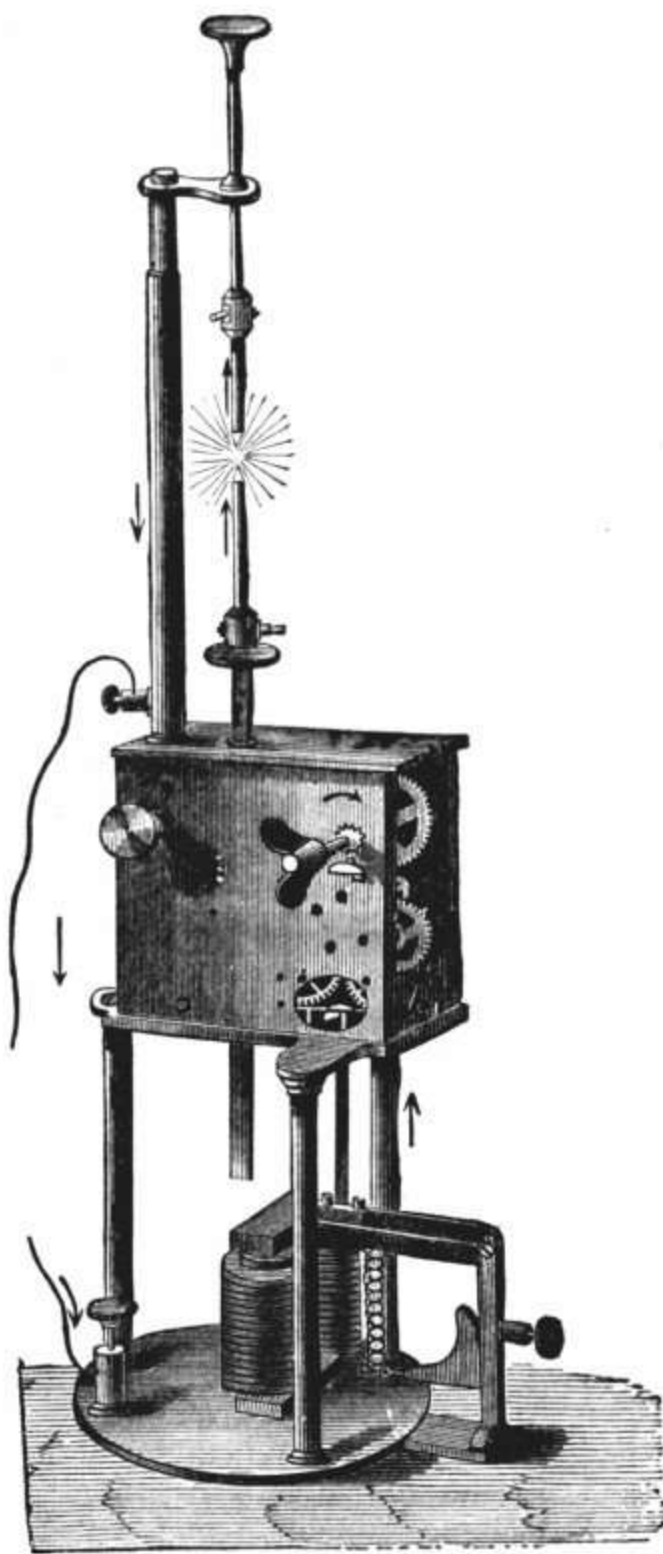

6308.

6305. ELECTRIC LIGHT REGULATOR. Simple form (Browning's). 30.00
6306. ELECTRIC LIGHT REGULATOR. Large model (Browning's). 95.00
6307. ELECTRIC LIGHT REGULATOR, with clock-work (Duboscq's). 95.00
6308. ELECTRIC LIGHT REGULATOR, with double clock-work. Foucault's arrangement. Prices on application.

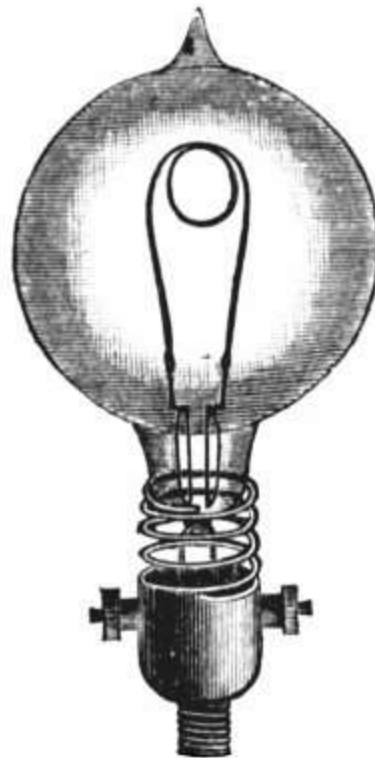

6319-6324.

We give below a list of Swan Lamps of different powers, together with the Dynamo Machines best suited for each.

6319.	Swan Lamp,	5 volt,		Machine No. 1.
6320.	"	"	9 "	" No. 2.
6321.	"	"	15 "	" No. 2.
6322.	"	"	20 " (2-in. series),	" No. 6.
6323.	"	"	40 "	" No. 6.
6324.	"	"	50 "	" No. 6.

Machine No. 6 will run from 4 to 6 lamps 40 to 50 volts, or 4 to 6 pairs of lamps 20 volts.

6330. **Miniature Swan Lamps**, 1 to 2 candle power (either globular or pointed in shape), fitted with socket holder.

6331. **Miniature Swan Lamps**, 2½ candle power.

Prices of Batteries arranged for above quoted on application.

### CARBONS FOR ELECTRIC LIGHT.

6400. **Carre's Celebrated French Carbons for Electric Light Experiments.** In sticks ½ metre long = 20 inches.

1 mm. diameter,	½ m. long,	.	.	.	.	.	.	.	.	\$0 10
2 mm. diameter,	½ m. long,	.	.	.	.	.	.	.	.	12
3 mm. diameter,	½ m. long,	.	.	.	.	.	.	.	.	15
4 mm. diameter,	½ m. long,	.	.	.	.	.	.	.	.	16
5 mm. diameter,	½ m. long,	.	.	.	.	.	.	.	.	20
6 mm. diameter,	½ m. long,	.	.	.	.	.	.	.	.	25
7 mm. diameter,	½ m. long,	.	.	.	.	.	.	.	.	30
8 mm. diameter,	½ m. long,	.	.	.	.	.	.	.	.	40
9 mm. diameter,	½ m. long,	.	.	.	.	.	.	.	.	45
10 mm. diameter,	½ m. long,	.	.	.	.	.	.	.	.	50
11 mm. diameter,	½ m. long,	.	.	.	.	.	.	.	.	60
12 mm. diameter,	½ m. long,	.	.	.	.	.	.	.	.	70
14 mm. diameter,	½ m. long,	.	.	.	.	.	.	.	.	90
15 mm. diameter,	½ m. long,	.	.	.	.	.	.	.	.	1 00

We can also furnish these with small holes through the centre.

6405. **The Wallace Diamond Carbons for Electric Lights.** Carbons of regular length and diameter, warranted for maximum resistance.

The following regular sizes, each 12 inches in length, can be had in quantity at short notice (other lengths made to order).

DIAMETER AND PRICES.

$\frac{1}{16}$	5 c. each.	$\frac{3}{8}$	11 c. each.	$\frac{3}{4}$	25 c. each.
$\frac{1}{8}$	5 "	$\frac{7}{16}$	13 "	$\frac{7}{8}$	28 "
$\frac{3}{16}$	6 "	$\frac{1}{2}$	15 "	1	34 "
$\frac{1}{4}$	6½ "	$\frac{9}{16}$	17 "	$1\frac{1}{4}$	40 "
$\frac{5}{16}$	8 "	$\frac{5}{8}$	20 "		

Packed 6 in each paper, 300 Carbons per case.

Carbons 6 and 12 in same price as 12 inch. Over 12 in. priced per foot.

NOTICE.—We pack these goods with great care, and are not responsible for breakage after shipping.

PRICES OF COPPER AND GERMAN SILVER WIRE.

All sizes of wire given in this catalogue are of Brown & Sharpe's Gauge, unless otherwise specified.

SIZE.		6410. Electric Copper.					6411. German Silver.			
No.	Diameter.	Bare.	Cotton Wound.			Silk Wound.		Bare.	Cotton Wound	Silk Wound
			Single.	Double	Triple.	Quad-ruple.	Single	Double.	Spools.	Spools.
			Spools.	Coils or Reels.	Coils.					
0000	.460	.....								
000	.40964	.....				0 @ 15.				
00	.36480	.....				50c. lb.				
0	.32495	.....								
1	.28930	.....				16 @ 20				
2	.25763	.....				60c. lb.				
3	.22942	.....								
4	.20431	.....								
5	.18194	.....								
6	.16202	.....								
7	.14428	.....								
8	.12849	.....								
9	.11443	.....								
10	.10189	.....								
11	.09074	.....								
12	.08081	.....								
13	.07196	.....								
14	.06408	0 30								
15	.05706	0 31								
16	.05082	0 31								
17	.04525	0 31½								
18	.04030	0 32								
19	.03589	0 32								
20	.03196	0 33								
21	.02846	0 34								
22	.025347	0 38								
23	.022571	0 40								
24	.0201	0 43								
25	.0179	0 46								
26	.01594	0 54								
27	.014195	0 62								
28	.012641	0 67								
29	.011257	0 73								
30	.010025	0 82								
31	.008928	0 95								
32	.00795	1 30								
33	.00708	1 50								
34	.0063	1 70								
35	.00561	2 00								
36	.005	3 25								
37	.00445	5 75								
38	.003965	10 00								
39	.003531									
40	.003144									

Furnished on spools of one pound each, when desired. Spools extra. Numbers less than 15 will not be furnished bare in quantities less than one pound. No wire will be furnished in quantities less than one-quarter pound.

6412. **Platinum Wire.**

No. 12, per inch,	\$0 75	No. 24, per inch,	\$0 06
" 14, "	50	" 26, per foot,	50
" 16, "	30	" 28, "	35
" 18, "	20	" 30, "	20
" 20, "	15	" 32, "	15
" 22, "	10	" 36, "	12
Nos. 12-26, per gramme,	.	.	35
" 28-36, "	.	.	40

6413. Annunciator or Burglar-alarm Wire, Double Wound.			6414. Office Wire.		6415. Gutta Percha Insulated Wire.		
No.	Ft. per lb.	Price.	Ft. per lb.	Price.	Ft. per lb.	Price per ft.	Price per lb.
12	—	\$0 34	35	\$0 35	38	\$0.05	\$1 50
13	—	34		35			
14	—	34	55	35	55	.03½	1 60
15	—	34		35			
16	—	34	95	35	72	.03	1 75
17	—	34		35			
18	160	34	135	35	126	.02	2 10
19	200	34		35			
20	225	34	155	35	175	.02	2 35
21							
22					230	.02½	2 60
23							
24					330	.01½	3 25
25							
26					480	.01	3 75

6416. **Office Wire Cables.** Each wire regular office wire.

Two Conductors only, No. 18 wire, per lb.,	\$0 35
Any number of conductors up to 100, No. 20 wire, per lb.,	35

6417. **Gas Furniture Wire.** White, yellow, or brown color.

	Braided.		Triple Wound Fine Cotton.		Triple Wound Silk.
No. 12.	\$0 40	No. 22.	\$0 90	No. 24.	\$2 50
" 15.	42	" 24.			
" 18.	45	" 26.			

6418. **Conducting Cords.**

No. 1. Single conductor of 16 copper wires, No. 33, in strand with green or red silk braid cover. Per yard,	15
No. 2. Single conductor of 16 copper wires, No. 31, in strand with green or red silk braid cover. Per yard,	19
No. 3. Double conductor of 5 copper wires each, No. 30, in strand with green silk braid cover. Per yard,	24
No. 4. Double conductor of 16 copper wires, No. 33, in strand with green silk braid cover. Per yard,	30
No. 5. Double conductor of 30 copper wires, No. 33, in strand with green silk braid cover. Per yard,	40
No. 6. Single conductor of 8 copper wires, No. 36, in strand with drab cotton braid cover. Per yard,	7



No. 7. Single conductor of copper wires wound spirally on a strong cord, with checked green, red, and white braid cover. Per yard,	\$0 10
No. 8. Same as No. 7, but smaller in size, with green cotton braid. Per yard,	7
No. 10. Single conductor of 50 copper wires, No. 32, with green and gold colored silk braid cover. For Rheostats and other purposes where large and flexible conductors are required. Per yard,	40
No. 11. Single conductor tinsel cord, with lateral cotton and double wrap of cotton cover, red or green, used for medical batteries. Per yard,	18
No. 12. Double conductor of 14 copper wires each, No. 33, in strands insulated with silk, covered with green crimson or blue silk, used for pear-shaped push buttons. Per yard,	30
No. 13. Single conductor, tinsel cord, covered with red or green worsted braid. Per yard,	12
No. 14. Double conductor, tinsel cord, one covered with blue, the other with red worsted braid, the whole covered with fine blue and red worsted braid. Per yard,	24
No. 15. Single conductor, tinsel cord, green or crimson silk braid cover. Per yard,	18
No. 15½. Double conductor, tinsel cord, green or crimson silk braid cover. Per yard,	30
No. 16. Single conductor, tinsel cord, one wrap worsted, two wraps cotton braid outside, for telephone switches. Per yard,	18
No. 18. Gold tinsel cord, not covered, small size. Per yard,	6
No. 19. " " " " " large " Per yard,	10
6419. Plated tips for cords, each,	3
6420. " " " " attached to the cord, each,	5

B. & S., or American.	Equivalent of Brown & Sharpe's Gauge in			Sizes of Gauges in Decimals of an inch.				
	New British Standard.	Old English, or London.	Stubs or Birmingham.	Brown & Sharpe or American Standard.	New British Legal Standard.	Old English, or London.	Stubs, or Birmingham.	
0000.....	000000	.....	.....	000000.....	.....	.500	.....	
000.....	000000	000000	000000	000000.....	.....	.464	.....	
00.....	000000	000000	000000	000000.....	.....	.432	.....	
0.....	000000	000000	000000	000000.....	.....	.400	.454	
1.....	000000	000000	000000	000000.....	.40964	.372	.425	
2.....	000000	000000	000000	000000.....	.36480	.348	.380	
3.....	000000	000000	000000	000000.....	.32495	.324	.340	
4.....	000000	000000	000000	000000.....	.28930	.300	.300	
5.....	000000	000000	000000	000000.....	.25763	.276	.284	
6.....	000000	000000	000000	000000.....	.22942	.252	.259	
7.....	000000	000000	000000	000000.....	.20431	.232	.238	
8.....	000000	000000	000000	000000.....	.18164	.212	.220	
9.....	000000	000000	000000	000000.....	.16202	.192	.203	
10.....	000000	000000	000000	000000.....	.14428	.176	.180	
11.....	000000	000000	000000	000000.....	.12849	.160	.165	
12.....	000000	000000	000000	000000.....	.11443	.144	.148	
13.....	000000	000000	000000	000000.....	.10189	.128	.134	
14.....	000000	000000	000000	000000.....	.09074	.116	.120	
15.....	000000	000000	000000	000000.....	.08081	.104	.109	
16.....	000000	000000	000000	000000.....	.07196	.092	.095	
17.....	000000	000000	000000	000000.....	.06408	.080	.083	
18.....	000000	000000	000000	000000.....	.05706	.072	.072	
19.....	000000	000000	000000	000000.....	.05082	.064	.065	
20.....	000000	000000	000000	000000.....	.04525	.056	.058	
21.....	000000	000000	000000	000000.....	.04030	.048	.049	
22.....	000000	000000	000000	000000.....	.03589	.040	.040	
23.....	000000	000000	000000	000000.....	.03196	.036	.035	
24.....	000000	000000	000000	000000.....	.02846	.032	.0315	
25.....	000000	000000	000000	000000.....	.02537	.028	.0295	
26.....	000000	000000	000000	000000.....	.022571	.024	.027	
27.....	000000	000000	000000	000000.....	.0201	.022	.025	
28.....	000000	000000	000000	000000.....	.0179	.020	.023	
29.....	000000	000000	000000	000000.....	.01594	.018	.0205	
30.....	000000	000000	000000	000000.....	.014195	.0164	.01875	
31.....	000000	000000	000000	000000.....	.012641	.0148	.0165	
32.....	000000	000000	000000	000000.....	.011257	.0136	.0155	
33.....	000000	000000	000000	000000.....	.010025	.0124	.01375	
34.....	000000	000000	000000	000000.....	.008928	.0116	.01225	
35.....	000000	000000	000000	000000.....	.00795	.0108	.01125	
36.....	000000	000000	000000	000000.....	.00708	.0100	.01205	
37.....	000000	000000	000000	000000.....	.0063	.0092	.0095	
38.....	000000	000000	000000	000000.....	.00561	.0084	.0090	
39.....	000000	000000	000000	000000.....	.005	.0076	.0075	
40.....	000000	000000	000000	000000.....	.00445	.0068	.0065	
				000000.....	.00395	.0060	.00575	
				000000.....	.003531	.0052	.005	
				000000.....	.003144	.0048	.0045	
				000000.....	.....	.0044	.....	
				000000.....	.....	.0040	.....	
				000000.....	.....	.0036	.....	
				000000.....	.....	.0032	.....	
				000000.....	.....	.0028	.....	
				000000.....	.....	.0024	.....	
				000000.....	.....	.0020	.....	
				000000.....	.....	.0016	.....	
				000000.....	.....	.0012	.....	
				000000.....	.....	.0010	.....	

**ELECTRICAL PROPERTIES OF COPPER WIRE.**

AMERICAN GAUGE.

Brown & Sharpe, Gauge.	Diameter.		Relation of weight to size.		Resistance of Pure Copper.		
	Inches.	Millime- tres.	Lbs. per 1000 ft.	Feet per lb.	Ohms per 1000 ft.	Ohms per lb.	Ft. per Ohm.
No.							
0000.....	.460	11.684	637.67	1.6	.049	.000077	20386.
000.....	.40964	10.405	504.28	2.5	.062	.00012	16196.
00.....	.364800	9.266	400.00	3.2	.078	.00019	12847.
0.....	.324960	8.254	314.59	3.	.099	.00031	10096.
1.....	.289300	7.348	252.27	4.	.124	.00049	8061.
2.....	.257630	6.544	202.08	5.	.154	.00076	6494.
3.....	.229420	5.827	158.24	6.3	.196	.00125	5077.
4.....	.204310	5.189	125.38	8.	.247	.00198	4031.
5.....	.181940	4.621	99.62	10.	.312	.00314	3200.
6.....	.162020	4.115	78.98	12.6	.392	.00499	2538.
7.....	.144280	3.665	62.65	16.	.498	.00797	2008.
8.....	.128490	3.264	49.43	20.	.629	.0127	1590.
9.....	.114430	2.907	39.39	25.	.782	.0199	1278.
10.....	.101890	2.558	31.25	32.	.998	.0319	1002.
11.....	.090742	2.305	24.77	40.	1.256	.0506	796.
12.....	.080808	2.058	19.51	51.	1.600	.0819	626.
13.....	.071961	1.828	15.53	64.	2.000	.1293	498.
14.....	.064084	1.628	12.31	81.	2.538	.2062	394.
15.....	.057068	1.450	9.75	102.	3.191	.3262	314.
16.....	.050820	1.291	7.76	129.	4.015	.5171	249.
17.....	.045257	1.150	6.16	162.	5.057	.8215	198.
18.....	.040303	1.024	4.87	204.	6.382	1.3.9	157.
19.....	.035390	.899	3.79	264.	8.239	2.175	121.
20.....	.031961	.812	3.08	325.	10.150	3.298	97.
21.....	.028462	.723	2.46	409.	12.750	5.185	78.
22.....	.025347	.644	1.93	517.	16.139	8.312	62.
23.....	.022571	.573	1.50	660.	20.871	13.59	49.
24.....	.020100	.511	1.20	823.	24.053	21.41	39.
25.....	.017900	.455	.94	1039.	34.281	34.2	31.
26.....	.015940	.405	.76	1310.	40.852	53.48	24.
27.....	.014195	.361	.61	1650.	51.515	85.	19.
28.....	.012641	.321	.48	2082.	64.894	136.5	15.
29.....	.011257	.286	.38	2623.	81.818	214.7	12.7
30.....	.010025	.255	.30	3311.	103.220	341.8	9.
31.....	.008928	.227	.24	4165.	129.583	540.6	6.7
32.....	.007950	.202	.19	5263.	164.140	863.8	6.1
33.....	.007080	.180	.15	6636.	206.951	1373.	4.8
34.....	.006304	.160	.12	8381.	261.363	2190.	3.8
35.....	.005614	.143	.10	10560.	332.311	3509.2	3.
36.....	.005000	.127	.08	13306.	414.962	5521.	2.4
37.....	.004453	.113	.06	16779.	526.316	8781.	1.9
38.....	.003965	.101	.05	20958.	666.666	13943.	1.5
39.....	.003531	.090	.04	26433.	833.333	21994.	1.2
40.....	.003144	.080	.03	33341.	1044.444	35016.	1.

**THE NEW BRITISH GAUGE.**

The Legal Standard in England, to take effect March 1st, 1884.

SUPERSEDING ALL OTHER GAUGES.

(From the London *Electrical Review*, Nov. 8d, 1883.) Reprinted in *Franklin Institute Journal*, August 8th, 1884.

GAUGE NUMBER.	DIFFERENCES.	DIAMETER.		AREA OF CROSS SECTION. Square Centimeters.	PURE COPPER WIRE (SOFT DRAWN).		WEIGHT OF WIRE. Density, 8.90 (Copper). Grammes per meter.
		Inches.	Centimeters.		Resistance. Ohms per meter.	Conductivity. Meters per ohm.	
	I.	II.	III.	IV.	V.	VI	VII.
7/0		.500	1.270	1.267	.000135	7402.1	1127.4
6/0	36	.464	1.178	1.090	.000157	6370.	970.2
5/0	32	.432	1.097	.945	.000181	5521.	840.8
4'0	32	.400	1.016	.811	.000211	4736.	721.3
2/0	28	.372	.945	.701	.000244	4098.	624.2
0	24	.348	.881	.613	.000279	3584.	545.9
1	24	.324	.832	.582	.000322	3107.	473.2
2	24	.300	.762	.546	.000375	2666.	406.1
3	24	.276	.701	.516	.000444	2233.	343.2
4	24	.252	.640	.482	.000532	1881.	286.5
5	20	.232	.589	.453	.000628	1542.	242.5
6	20	.212	.538	.428	.000751	1331.	202.7
7	16	.192	.488	.407	.000916	1092.	166.3
8	16	.176	.447	.387	.00109	917.8	139.8
9	16	.160	.406	.370	.00132	757.2	115.3
10	16	.144	.366	.355	.00163	614.9	93.7
11	12	.128	.325	.349	.00206	484.6	73.8
12	12	.116	.295	.338	.00251	398.3	60.7
13	12	.104	.264	.330	.00312	320.3	48.8
14	12	.092	.234	.324	.00398	250.6	38.2
15	8	.080	.203	.324	.00528	189.5	28.9
16	8	.072	.183	.328	.00651	153.5	23.4
17	8	.064	.163	.334	.00824	121.3	18.5
18	8	.056	.142	.342	.0108	92.7	14.1
19	8	.048	.122	.352	.0147	68.2	10.4
20	4	.040	.1016	.362	.0211	47.4	7.19
21	4	.036	.0914	.372	.0260	38.4	5.84
22	4	.032	.0813	.382	.0330	30.3	4.62
23	4	.028	.0711	.392	.0431	23.2	3.54
24	4	.024	.0610	.402	.0587	17.05	2.60
25	2	.022	.0559	.412	.0698	14.32	2.18
26	2	.020	.0508	.422	.0845	11.84	1.80
27	1.6	.018	.0457	.432	.104	9.59	1.46
28	1.6	.0164	.0417	.442	.125	7.97	1.21
29	1.2	.0148	.0376	.452	.154	6.48	.988
30	1.2	.0136	.0345	.462	.183	5.46	.834
31	.8	.0124	.0315	.472	.220	4.55	.693
32	.8	.0116	.0295	.482	.251	3.98	.607
33	.8	.0108	.0274	.492	.290	3.45	.526
34	.8	.0100	.0254	.502	.338	2.96	.451
35	.8	.0092	.0234	.512	.398	2.51	.382
36	.8	.0084	.0213	.522	.478	2.09	.318
37	.8	.0076	.0193	.532	.585	1.71	.260
38	.8	.0068	.0173	.542	.730	1.37	.208
39	.8	.0060	.0152	.552	.943	1.06	.162
40	.4	.0052	.0132	.562	1.248	.801	.122
41	.4	.0048	.0122	.572	1.466	.682	.1038
42	.4	.0044	.0112	.582	1.742	.574	.0874
43	.4	.0040	.0102	.592	2.109	.474	.0721
44	.4	.0036	.00914	.602	2.611	.383	.0584
45	.4	.0032	.00813	.612	3.300	.303	.0462
46	.4	.0028	.00711	.622	4.310	.232	.0353
47	.4	.0024	.00610	.632	5.848	.171	.0260
48	.4	.0020	.00508	.642	8.475	.118	.0180
49	.4	.0016	.00406	.652	13.23	.076	.0115
50	.2	.0012	.00305	.662	23.42	.043	.00650
50	.2	.0010	.00254	.672	33.78	.030	.00451

For Prices of Copper Wire, see page 173.

B. & S. AMERICAN GAUGES.



6430-31.

6430. Round Gauges, for wire from No. 0 to 36,	. . . . .	\$4 00
6431. Round Gauges, " " " No. 5 to 36,	. . . . .	3 00
6435. Micrometer Caliper, Machinists',	. . . . .	5 00
6436. Micrometer Caliper, " Morocco case,	. . . . .	5 50

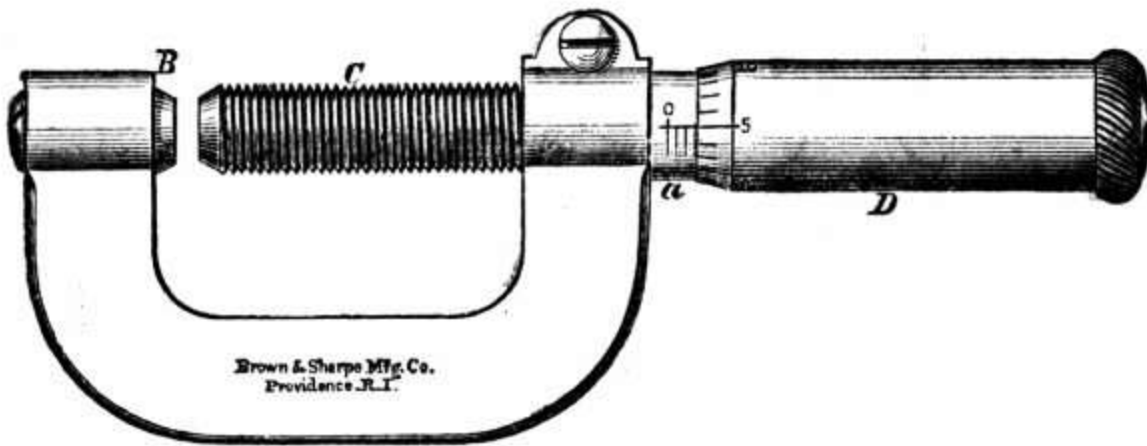

6437.

6437. Micrometer Caliper, Metric,	. . . . .	5 00
6438. Micrometer Caliper, " Morocco case,	. . . . .	5 50

**CONNECTORS.**

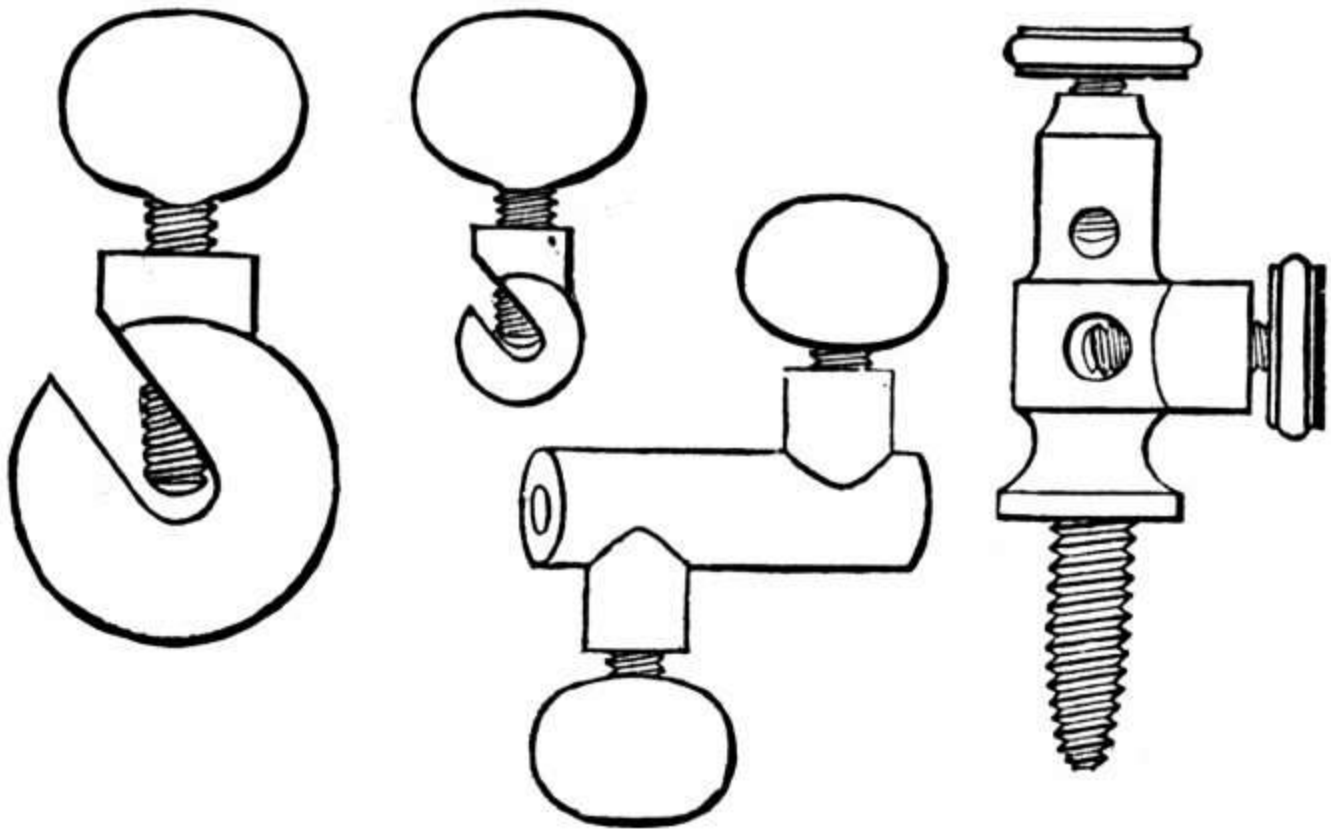

6451.

6452.

6450.

6464.

6450. No. 1. Plain Double Connector,	. . . . .	\$0 10
6451. No. 2. Improved Double Connector, large, holding firmly from 2 to 7 wires,	. . . . .	20
6452. No. 3. Improved Double Connector, small,	. . . . .	08

**BINDING POSTS.**

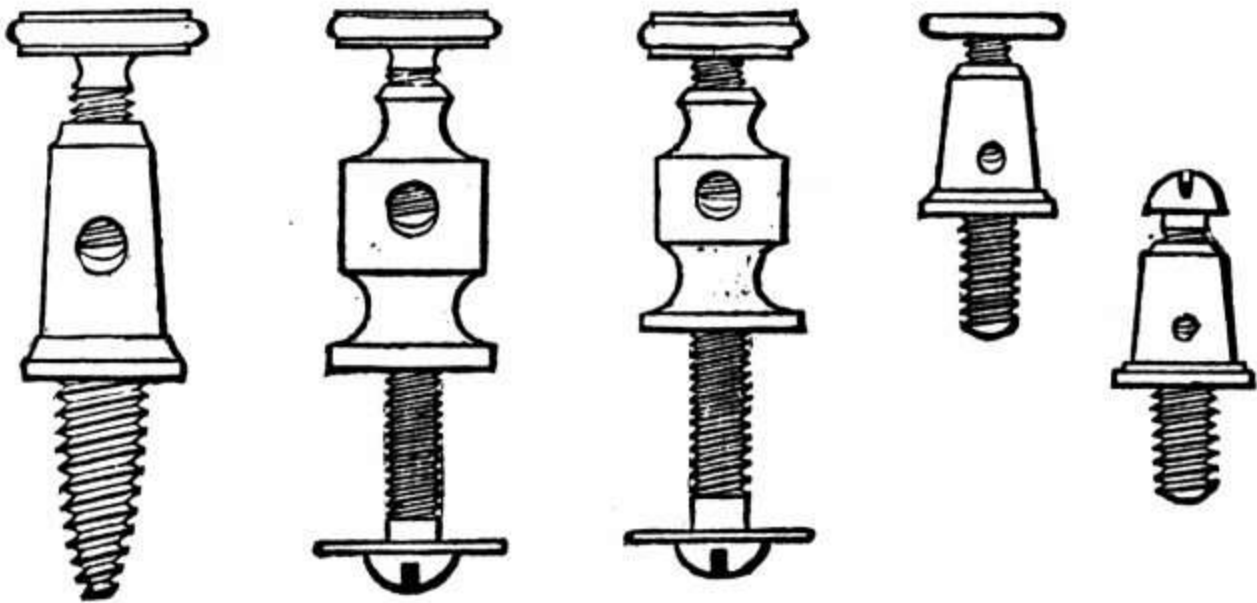

6457.

6459.

6458.

6456.

6455.

6455. No. 1. Telephone Binding Post,	. . . . .	10
6456. No. 2. Telephone Binding Post,	. . . . .	10
6457. No. 3. Woodscrew Binding Post,	. . . . .	12

6458. No. 4. **Instrument Binding Post, small,** . . . . . \$0 12  
 6459. No. 5. **Instrument Binding Post, large,** . . . . . 15

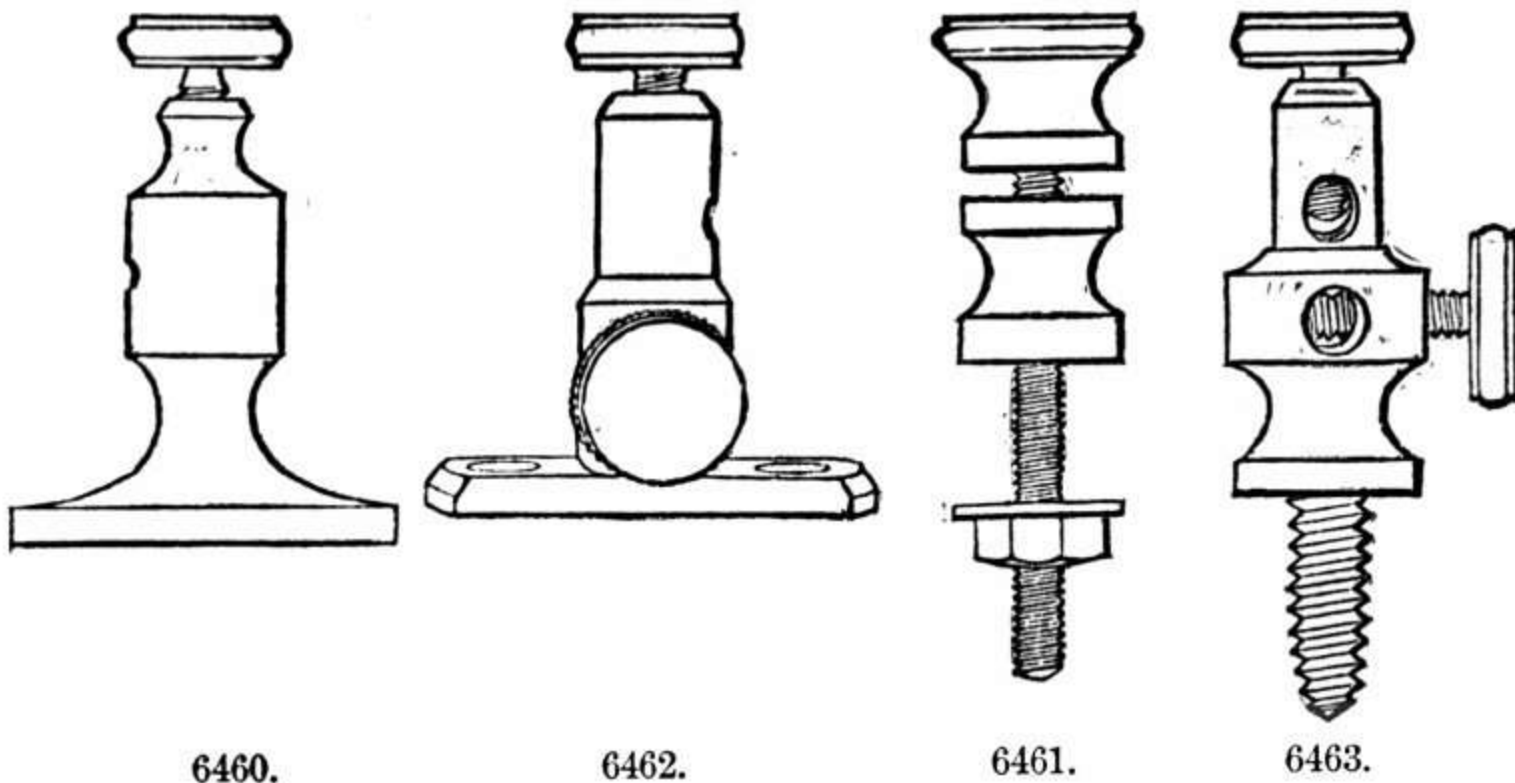

6460. No. 6. **Flat Base Window Tube Binding Post,** . . . . . \$0 20  
 6461. No. 7. **English Binding Post,** . . . . . 18  
 6462. No. 8. **Flat Base Double Binding Post,** . . . . . 18  
 6463. No. 9. **Woodscrew Double Binding Post,** . . . . . 15  
 6464. No. 10. **Woodscrew Double Binding Post, very fine finish,** . . . . . 18

**PUSH BUTTONS.**

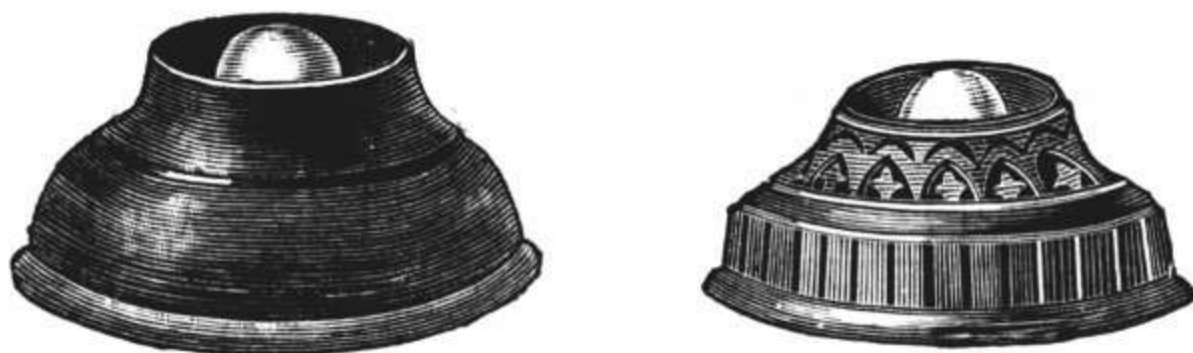

- 6470-6472. . . . . \$0 30  
 6470. **Rosewood, fine finish,** . . . . . 25  
 6471. **Walnut,** . . . . . 25  
 6472. **Mahogany,** . . . . . 50  
 6473. **Bronze, fancy,** . . . . . 50  
 6474. **N. P. Push Button, plain,** . . . . . 75  
 6475. **N. P. Push Button, fancy,** . . . . . 30  
 6476. **Porcelain Push Button, plain,** . . . . . 50  
 6477. **Porcelain Push Button, fancy,** . . . . .





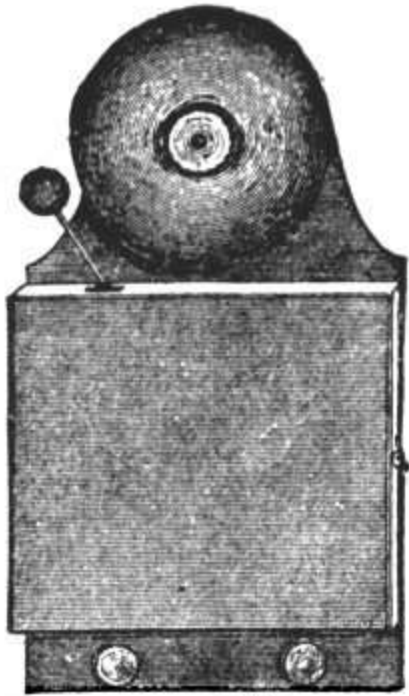

6490.

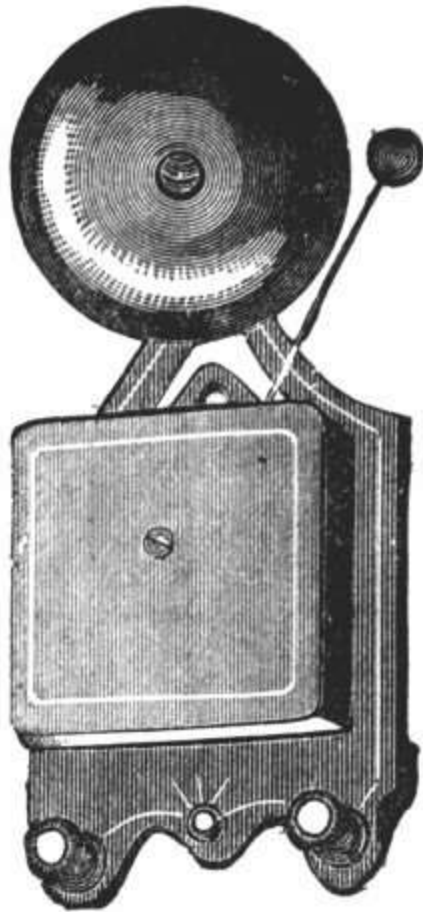

6491.

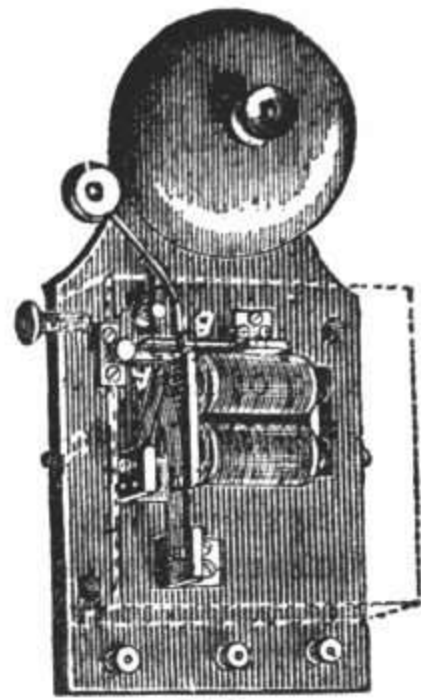

6492.

6491. **Electric Vibrating Bells. Box.** With Continuous Ring, until specially stopped.

2½ inches, N. P.,	.	.	.	.	.	.	.	.	.	.	.	\$4 00
3 " "	.	.	.	.	.	.	.	.	.	.	.	4 25
3½ " "	.	.	.	.	.	.	.	.	.	.	.	4 50
4 " "	.	.	.	.	.	.	.	.	.	.	.	4 75
5 " "	.	.	.	.	.	.	.	.	.	.	.	7 00
6 " "	.	.	.	.	.	.	.	.	.	.	.	8 00

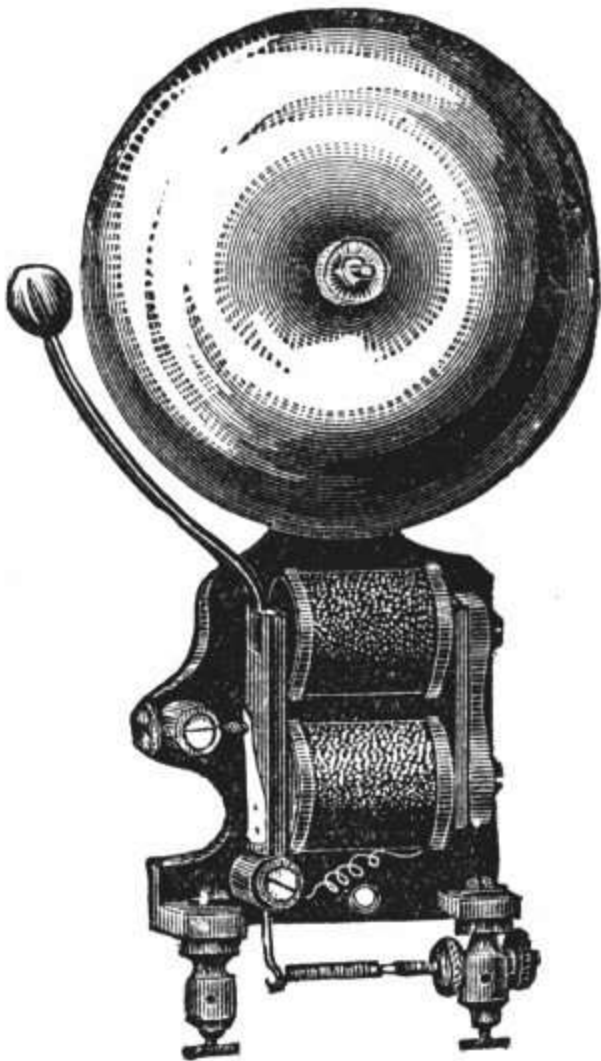

6493.

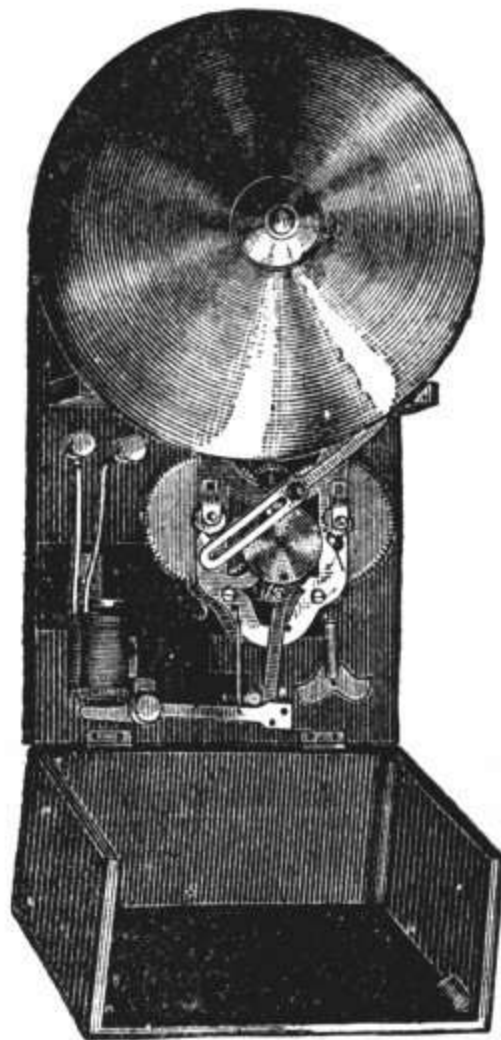

6495.

6492. **Electric Vibrating Bell. Box.**

2½ in. Bell, N. P., Enameled Metal Box,	. . . . .	\$2 50
3 " " " " " "	. . . . .	3 00
3½ " " " " " "	. . . . .	3 25
4 " " " " " "	. . . . .	3 50

6493. **Skeleton Bells.**

2½ in. Gong, Single or Vibrating Stroke,	. . . . .	3 50
3½ " " " " " "	. . . . .	3 75
4 " " " " " "	. . . . .	4 00
5 " " " " " "	. . . . .	4 25
6 " " " " " "	. . . . .	5 25
7 " " " " " "	. . . . .	5 75
8 " " " " " "	. . . . .	7 50
10 " " " " " "	. . . . .	15 00
12 " " " " " "	. . . . .	18 00

6494. **Buzzer.** Mahogany Base, N. P. cover, . . . . . 2 00

6495. **Electric Striking Gongs.** Run by clock-work.

6 in. Gong,	. . . . .	21 50
8 " "	. . . . .	22 75
9 " "	. . . . .	23 50
10 " "	. . . . .	25 00
12 " "	. . . . .	28 00

**TELEGRAPH APPARATUS.**

6500. **The Giant Sounder,** latest improved form, with N. P. Resonating Metal Base, . . . . . 4 00

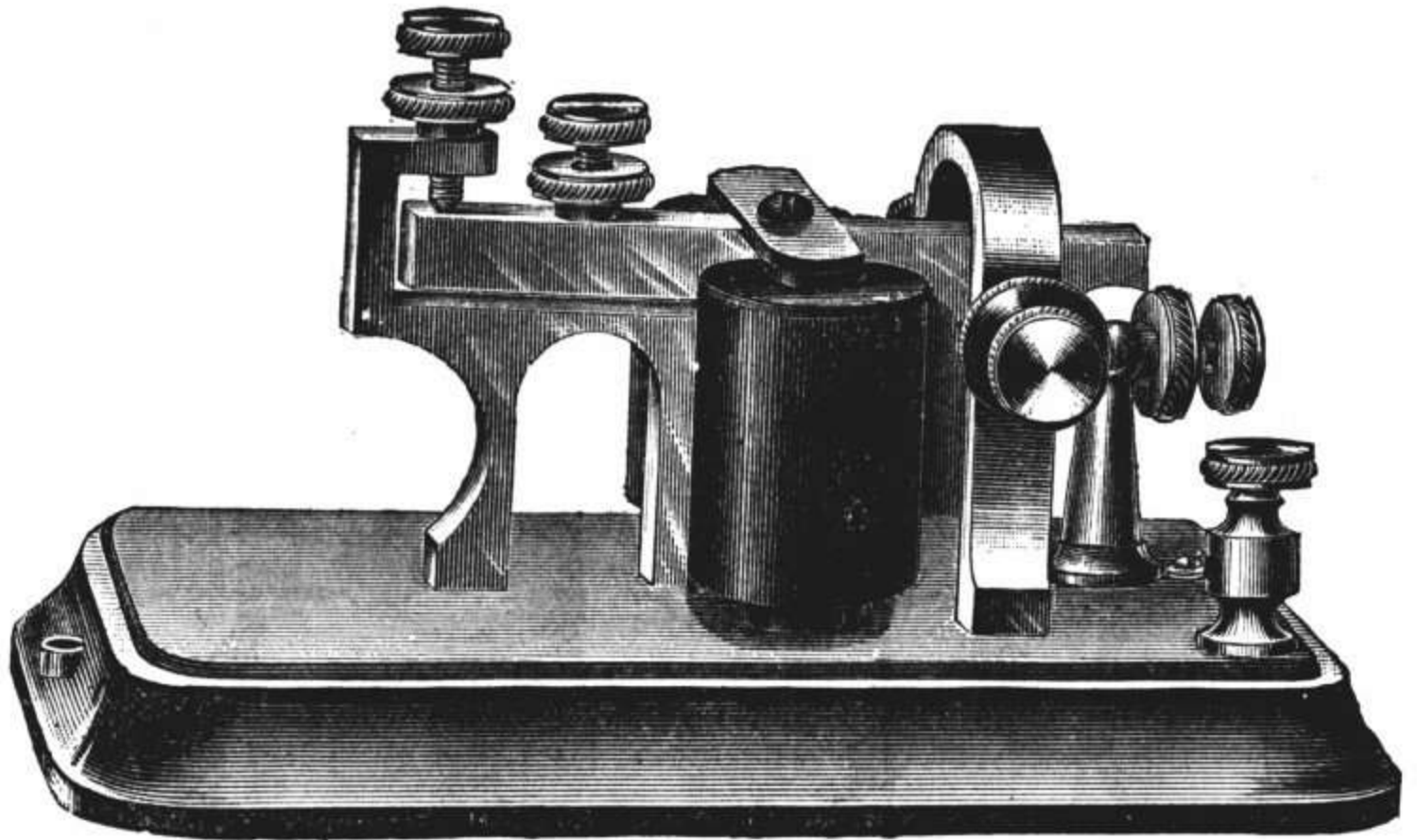

6500.

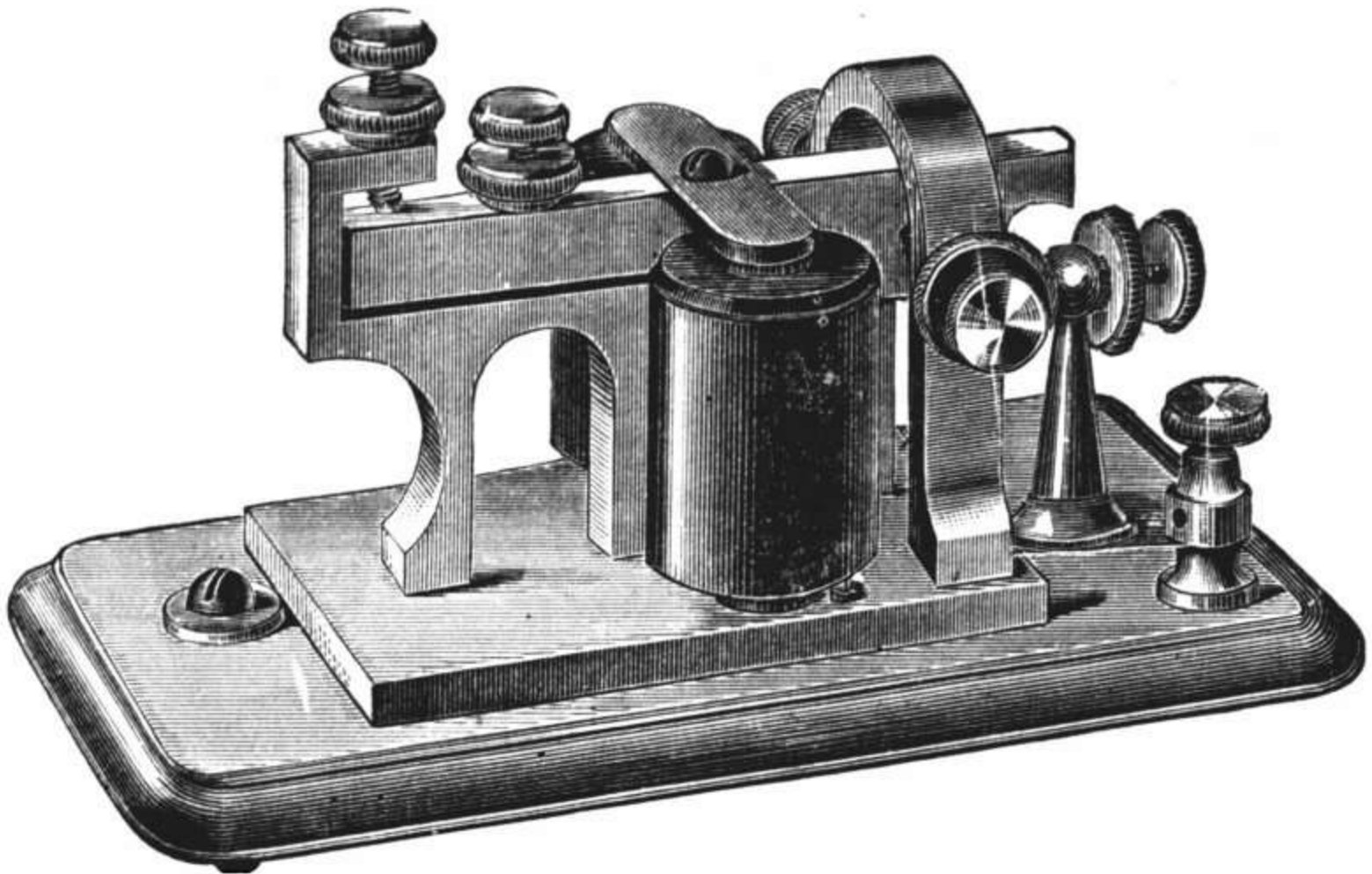

6505.

6501. Same as No. 6500, wound to 20 Ohms resistance; can be used on lines up to fifteen miles without relay, . . . . .	\$4 50
6502. <b>Repeating Sounder</b> , plain points, . . . . .	6 50
6503. <b>Repeating Sounder</b> , spring points, . . . . .	7 50
6504. <b>Circuit Preserving Single Transmitters</b> , . . . . .	7 50
6505. <b>Giant Sounder</b> , . . . . .	3 50

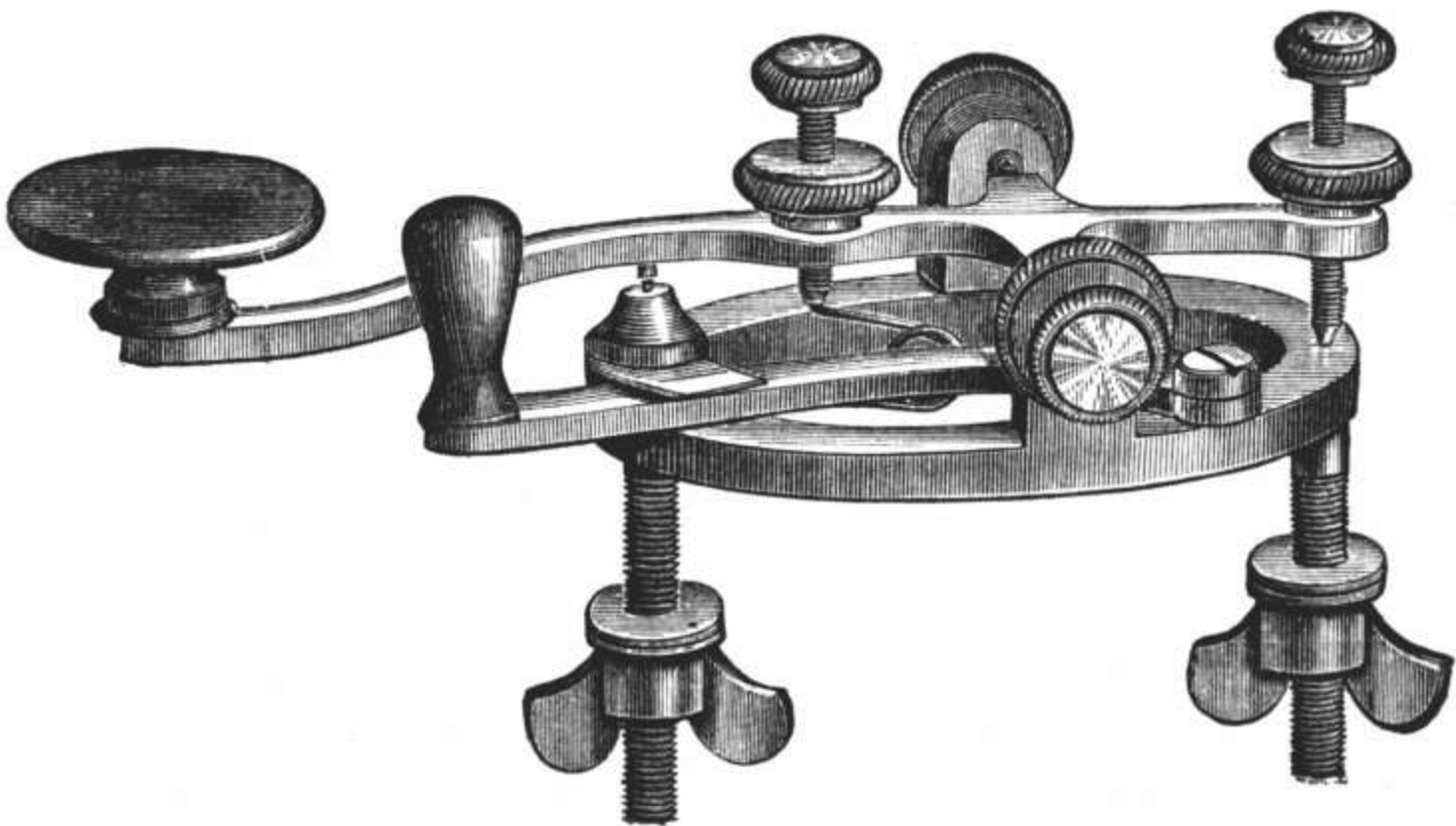

6515.

6506. <b>Giant Sounder</b> , 20 Ohms resistance, for lines use, up to 15 miles, .	\$4 00
6507. <b>Giant Sounder</b> , 20 Ohms resistance, and steel lever key, . . .	7 00
6508. <b>Giant Sounder</b> , 3 Ohms resistance, and steel lever key, . . .	6 50
6509. <b>Giant Sounder</b> , 3 Ohms resistance and steel lever key and battery complete, . . . . .	7 75

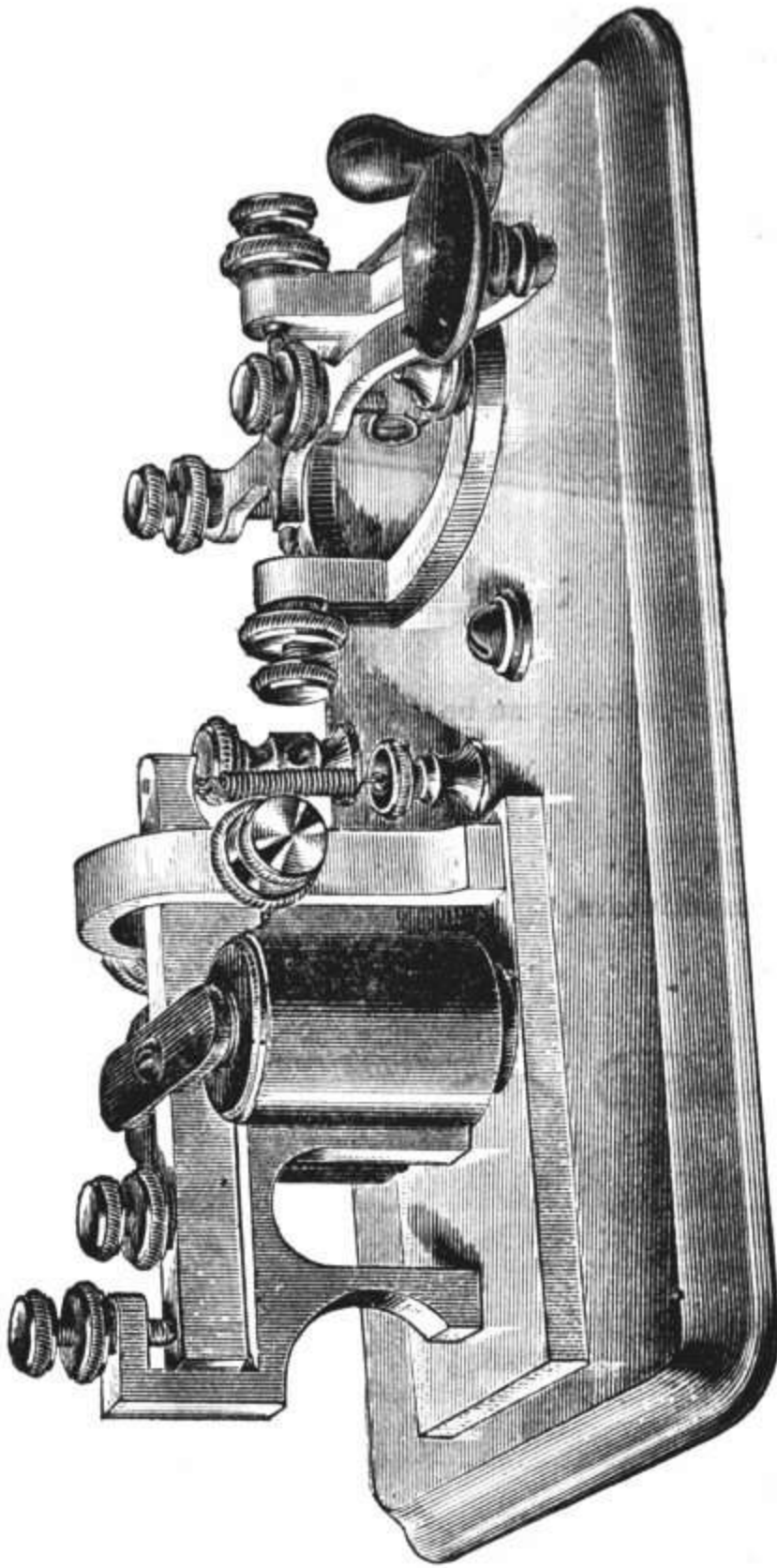

6507.

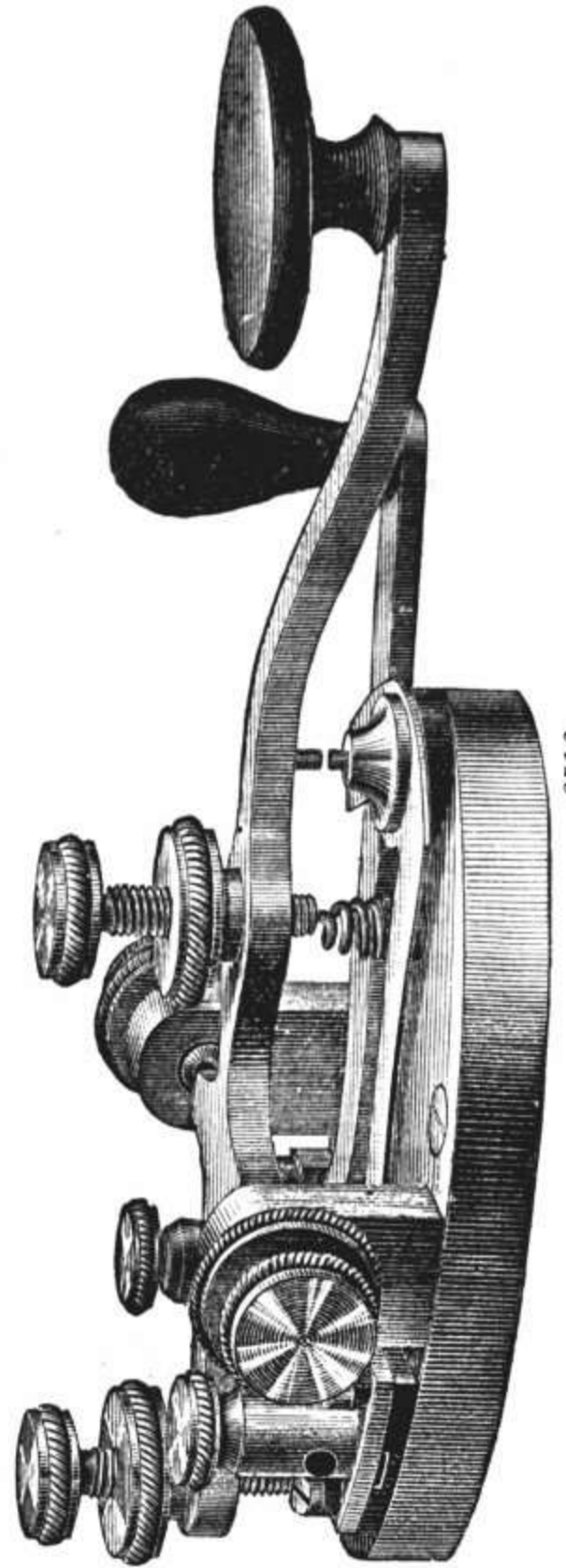

6516.

6515. <b>Steel Lever Solid Trunnion Key</b> , straight or curved, . . .	3 00
6516. <b>Legless Pattern Steel Lever Key</b> , . . . . .	3 25
6520. <b>Relay</b> , solid trunnion single piece armature, 150 Ohms resistance, silk covered wire, polished rubber covered coils, mahogany base on ornamental surbase, extension adjustment, . . . . .	7 00

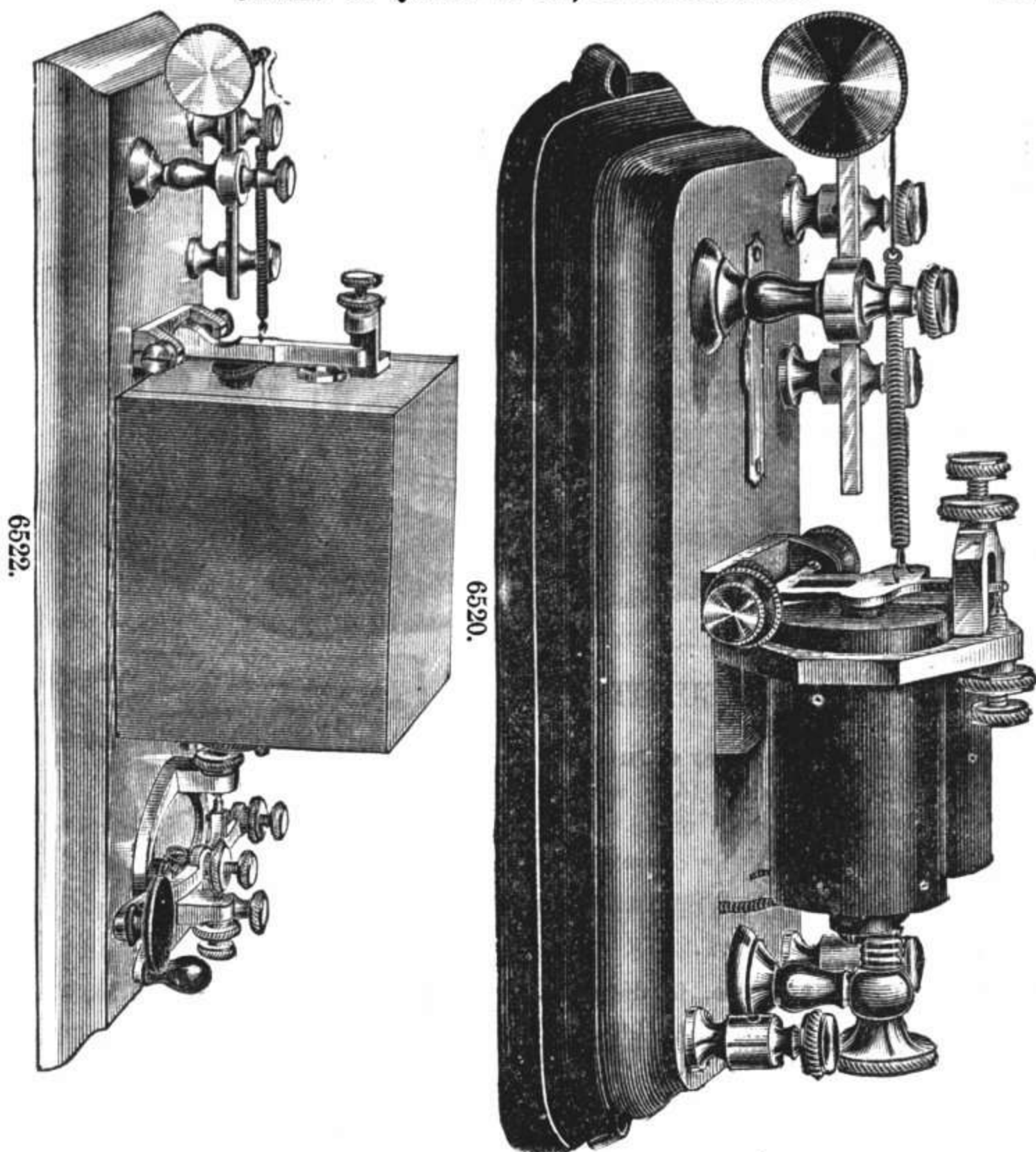

- 6521. **Relay**, solid trunnion single piece armature, 160-300 Ohms resistance, silk covered wire, polished rubber covered coils, mahogany base on ornamental surbase, extension adjustment, . . . . . \$8 00
- 6522. **Box-sounding Relay and Steel Lever Key**, combination set, . . . . . 11 00
- Box-sounding Relay**, without key, . . . . . 8 50

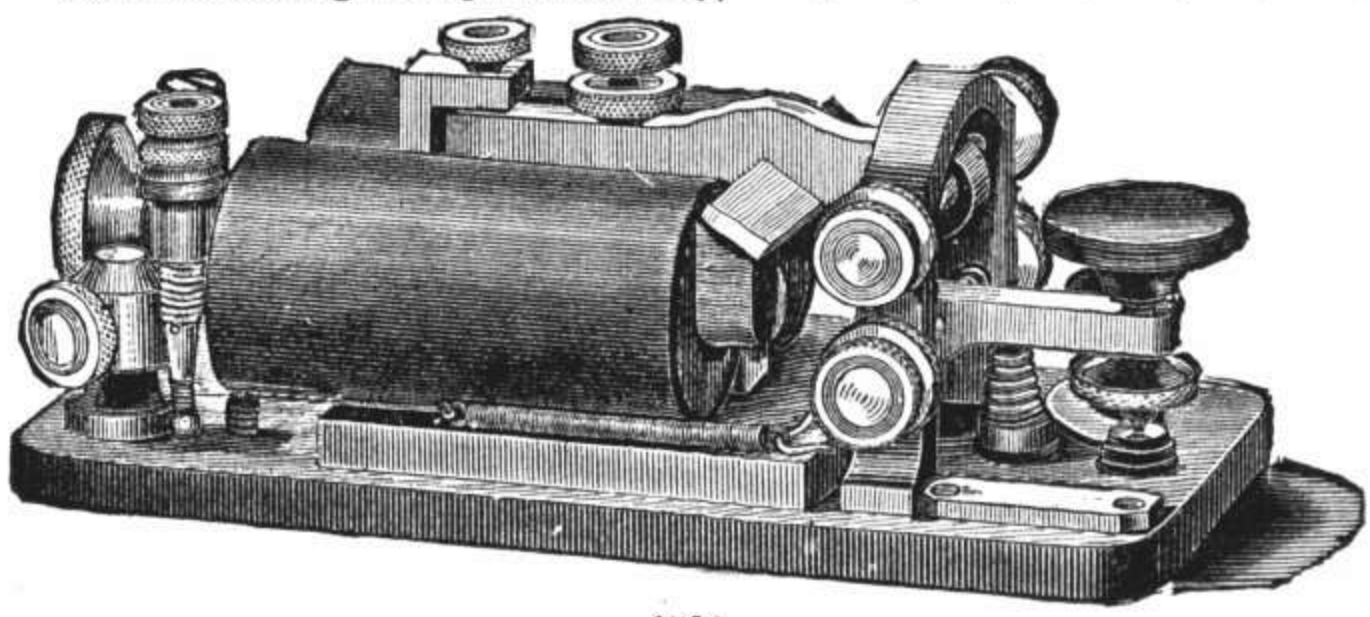

- 6523. **Bunnell Pocket Relay**,  $5\frac{3}{4} \times 2\frac{3}{4} \times 2\frac{1}{2}$ , with key, . . . . . 16 00

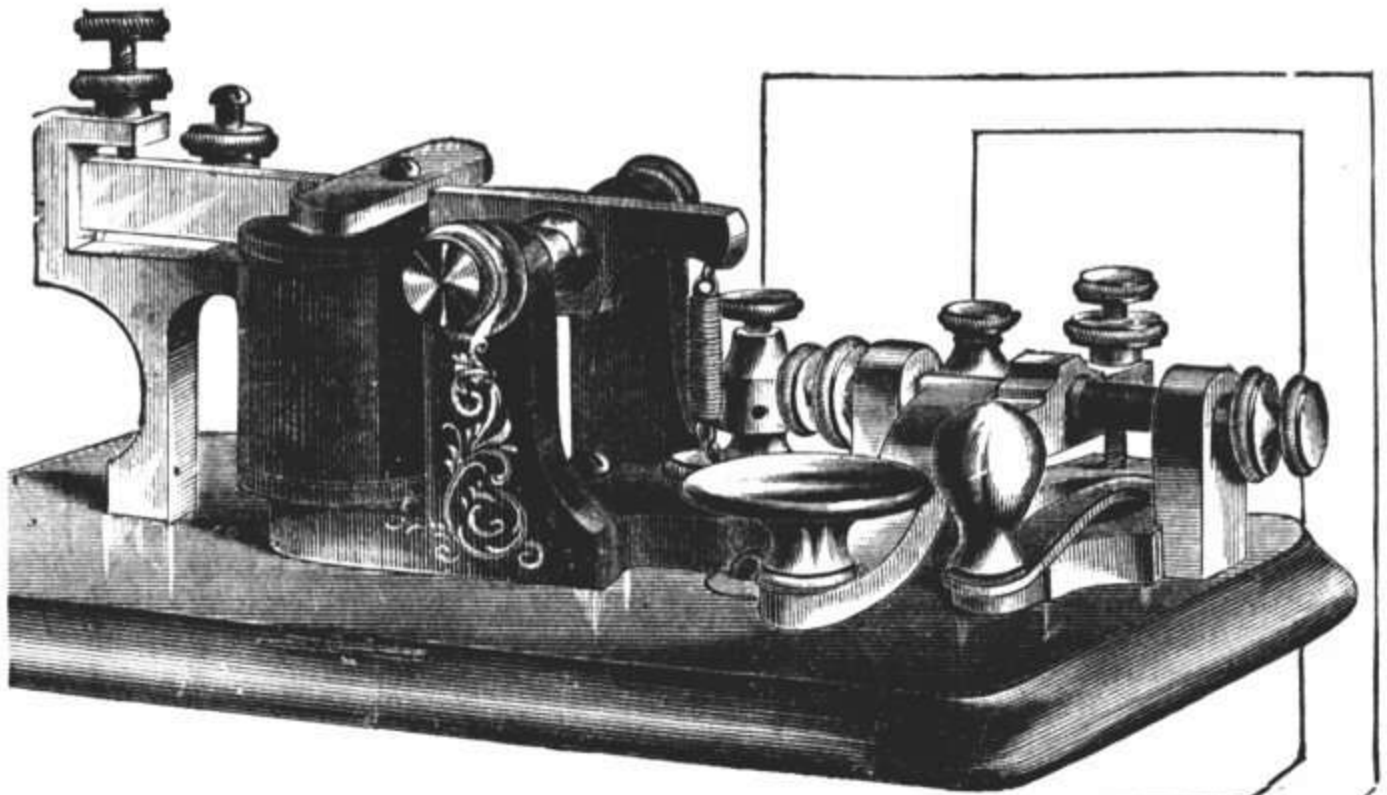

### LEARNERS' OUTFITS.

- |   |        |
|---|--------|
| 6530. <b>The Morse Learner's Outfit,</b><br>complete, with battery wire,<br>chemicals, and all other nec-<br>essary materials for operating,<br>and book of instructions, . . . | \$3 75 |
| 6531. <b>Instrument alone,</b> . . .  | 3 00   |
| 6532. <b>Instrument alone,</b> for distan-<br>ces from 200 feet to 10 or 15<br>miles, . . . . .   | 3 75   |

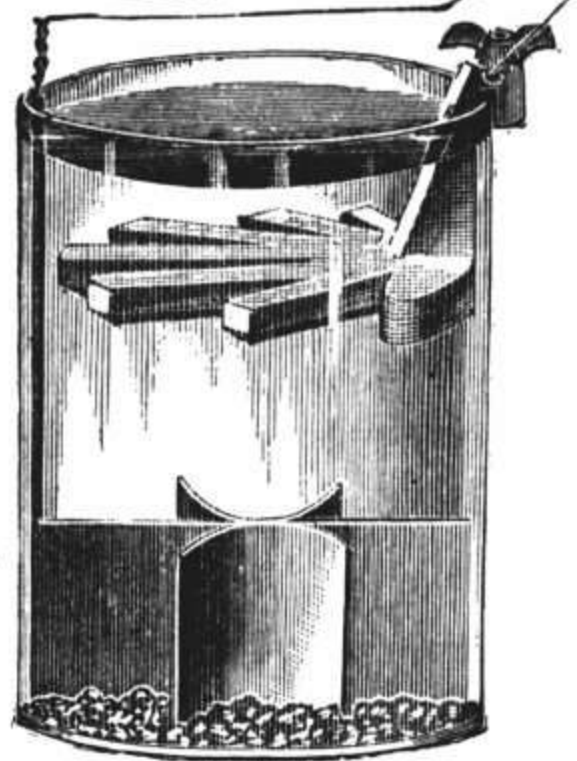

## CHAPTER VIII.

## ASTRONOMY.

The following list of the celebrated "Joslin" Globes are unexcelled for the character of workmanship they exhibit; they are the best globes in the market, for the following reasons, viz.:—they may be depended upon as accurate, the plates having lately been revised, to correspond with all recent political changes. All the maps are printed directly from copper plates, and are not lithographed. The meridians are accurately graduated. The varnish is warranted not to crack or peel off, a common failing. The general workmanship throughout is of the first order. These globes have long enjoyed a reputation for superior accuracy, durability and beauty.

Professor John D. Philbrick, United States Commissioner of Education to the late Paris Exhibition, says of them:—"For school use, I know of no globes equal to Joslin's in accuracy, in excellence of material and workmanship, as well as in reasonableness of price. They cannot fail to give satisfaction."



6680.

This globe is adapted to individual beginners and others not desiring the details of a large globe. It is a most fitting and useful present to any beginner in geography. The maps are very accurate and handsomely engraved.

The Terrestrial globe contains the leading political divisions, each of which is distinctly and separately colored, the principal cities, bays, rivers, islands, capes, etc.

The Celestial contains the stars up to the fifth magnitude (inclusive), and the constellations are appropriately colored.

The stand is of polished black walnut, to which the globe is secured at an angle of  $23\frac{1}{2}^{\circ}$  from the perpendicular, in a graduated half meridian of polished brass, in which the globe can be revolved at will. The stands are somewhat taller than shown in the cut.

	PRICE
6680. <b>Terrestrial Globe</b> , 6-inch semi-frame.....	\$3 25
6681. Terrestrial Globe, 9½-inch frame.....	7 75
6682. Terrestrial Globe, 12-inch frame.....	11 00
6683. <b>Terrestrial Globe</b> , 6-inch full frame. This style differs from the semi-frame in being so mounted as to adapt it for use in working problems. It is furnished with a graduated horizon on which are the calendar months with the corresponding signs of the Zodiac, and also with a full brass meridian graduated to degrees, an hour dial and an index.....	\$6 75

We will furnish the above, either Terrestrial or Celestial, at same price.



6683.



6684.



6684. **Terrestrial Globe.** Bronze pedestal stand, rotary frame. Mounted in this manner the globe is brought to a convenient height for use while sitting, and at the same time presents an ornamental appearance, adapting it to the parlor and library as well as to the school-room. It is furnished with horizon, graduated full brass meridian, hour dial, etc. The bronzed iron stand is of such design as to combine great strength with light weight and symmetrical appearance. 12-inch diameter, extreme height, 3 feet 2½ inches..... \$24 50
6685. **Terrestrial Globe.** 16-inch diameter, extreme height to top of meridian, 3 feet 6½ inches..... 42 50
6686. **Terrestrial Globe.** 12-inch globe similar to 6684, but mounted on tripod of japanned wood, with decoration, very suitable for parlor or library..... 24 50
6687. **Terrestrial Globe.** 16-inch globe mounted same as 6686..... 42 00

We will furnish the above, either Terrestrial or Celestial, at same price.



6688.

6688. **Terrestrial Globe.** 9½-inch low bronze rotary frame. This style with black walnut horizon, graduated full brass meridian, hour dial, etc., is mounted upon a light bronze stand of neat and appropriate design. The arms which support the horizon are pivoted to the base, thus allowing any portion of the globe to be turned to the student without changing the position of the base itself, a very desirable arrangement. The pivot is of wrought iron, turned to fit a conical bearing. It can thus never wear loose, and is warranted to remain in order with constant usage..... 12 00

	PRICE
6689. Terrestrial Globe. 12-inch low bronze rotary frame.....	\$16 25
6690. Terrestrial Globe. 16-inch low bronze rotary frame. The meridian is graduated into half degrees, and the globe is furnished with a brass hour circle at each pole.....	32 60

We will furnish the above, either Terrestrial or Celestial, at same price.



6691.

6691. Terrestrial Globe. 9½-inch globe with full frame, mounted upon a substantial cherry wood stand, with horizon, graduated full brass meridian, hour dial and index. This globe has all the appliances for use in the solution of problems.....	11 00
6692. Terrestrial Globe. 12-inch globe with full frame.....	14 25
6693. Terrestrial Globe. 16-inch globe with full frame, similar to 6692, but the meridian is graduated into half degrees, and the globe is furnished with a brass hour circle at each pole.....	30 00

We will furnish the above, either Terrestrial or Celestial, at same price.

We will furnish slated globes, of either of the above sizes and styles, 15 per cent. less.

#### SCHEDLER GLOBES.

6694. <b>The Scientific Globe.</b> 20-inch diameter. Scale, 1:25,000,000. Complete. On bronzed pedestal frame 42 inches high, with horizon, (cast-iron, nickel-plated) meridian divided into half degrees hour circle and quadrant.....	75 00
Case and packing.....	5 00

	PRICE
6695. The Scientific Globe. With full meridian, on bronzed pedestal frame, with full (cast iron) meridian, and inclined axis.....	\$60 00
Case and packing.....	4 00
6696. The Scientific Globe. Plain. On plain iron stand, with inclined axis..	55 00
Case and packing.....	4 00
6697. <b>The Three-Inch Terrestrial Globe.</b> In paper box.....	1 50
Boxing.....	25
6698. <b>Terrestrial Hemisphere Globes.</b> 6 inches diameter.....	3 00
Boxing.....	40

SUSPENDED GLOBES.

6699. <b>The Twenty-Inch Terrestrial Suspended Globe</b> .....	\$40 00
Case and packing.....	2 50
6700. The Twelve-Inch Terrestrial Suspended Globe.....	10 00
Case and packing.....	1 25
6701. The Nine-Inch Terrestrial Suspended Globe.....	8 00
Case and packing.....	60
6702. The Six-Inch Terrestrial Suspended Globe.....	6 00
Case and packing.....	40

We will furnish twenty-inch, twelve-inch or nine-inch sizes of above, either Terrestrial or Celestial, at same price.

HOLBROOK'S GLOBES.



6703.



6704.

6703. <b>Terrestrial Globe.</b> 12-inch bronze rotary frame.....	\$16 50
6704. <b>Terrestrial Globe.</b> 12-inch bronze tripod frame.....	13 50



6705.



6706.

6705. Terrestrial Globe. 12-inch plain stand frame.....  
 6706. Terrestrial Globe. 6-inch, semi-frame.....

PRICE  
 \$9 00  
 3 25



6707.

6707. **Solar Telluric Globe.** Six inches in diameter, with descriptive manual of thirty pages. The arrangement of this instrument shows the cause of the seasons, of the different lengths of the day in different latitudes, etc., etc.....

10 00

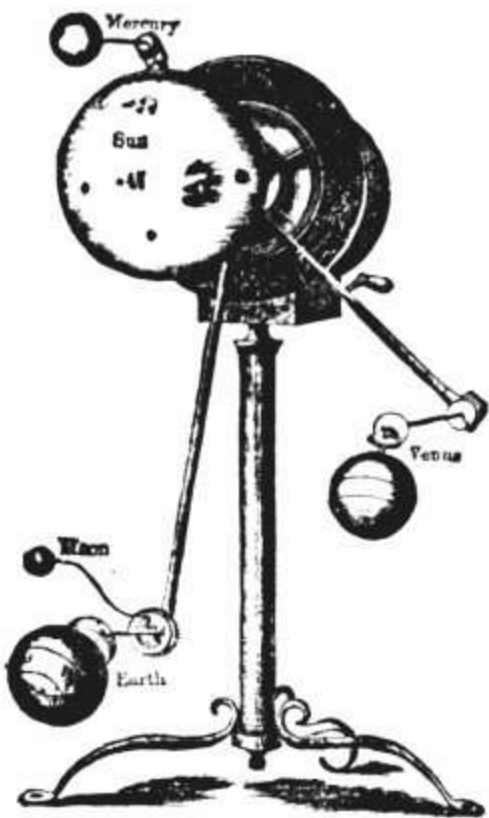

6708.



6710.—WHEN USED AS A TELLURIAN.

- |   | PRICE   |
|---|---------|
| 6708. <b>Heliotellus.</b> This instrument illustrates the astronomical phenomena of the sun, Mercury, Venus, the earth and moon, is finely finished in brass, with key..... | \$30 00 |
| 6709. <b>Lunatellus.</b> Illustrating the motions of the sun, earth, moon, etc., is finished in brass, with key. Only.....  | 20 00   |

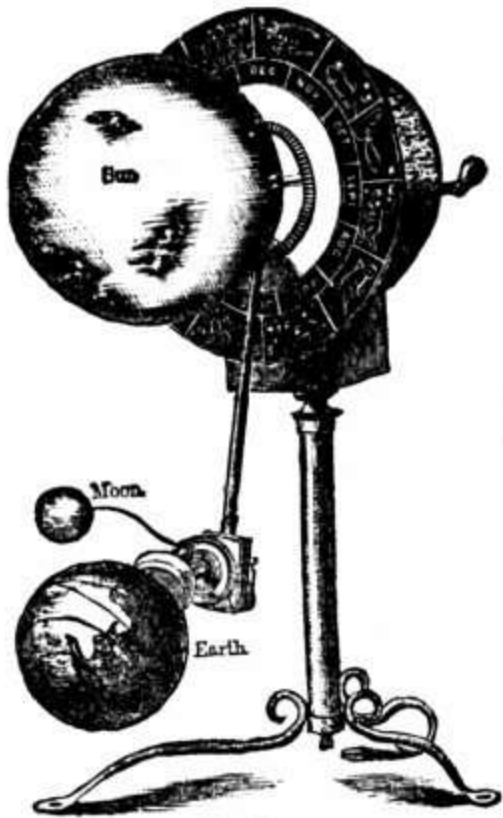

6709.



6710.—WHEN USED AS A LUNARIAN.

**NEW LUNAR TELLURIC GLOBE.**

The latest perfected Globe in the market. With it you can readily explain to the pupil "Moon's Phases," viz.:

"New Moon," "First Quarter," "Full Moon," "Last Quarter," "Old Moon," Eclipse of the Sun, Eclipse of the Moon, Tides, Change of Seasons, Summer and Winter Solstice and many other phases. Mountings are also included, and thus afford a Globe without Meridians or Horizons, and prevents confusing the ideas of the pupil in explaining its features.

- |  | PRICE   |
|--|---------|
| 6710. <b>New Lunar Telluric Globe, 6-inch Ball</b> ..... | \$20 00 |

- |  |                  |
|--|------------------|
| 6711. New Lunar Telluric Globe, 8-inch Ball.....   | PRICE<br>\$30 00 |
| 6712. <b>Fitz's New Terrestrial 12-inch Globe</b> , mounted in an entirely novel manner. The stand supports on its upper surface a metallic disc revolving on an axis, representing the progress of the earth in its orbit. The disc has concentric circles, with the names of the months, signs of the ecliptic and subdivisions for each day of the month. It is also graduated to degrees, with index. Attached to the disc, at an angle of $66\frac{1}{2}^{\circ}$ is a rod, representing the axis of the earth, upon which the globe revolves, its centre being vertically over the centre of the disc; an index points towards the centre of the globe, representing a central ray of solar light. The divisions of day and night, line of twilight, and horizon line, are shown by brass rings..... | 24 00            |

## TELLURIANS AND PLANETARIUMS.

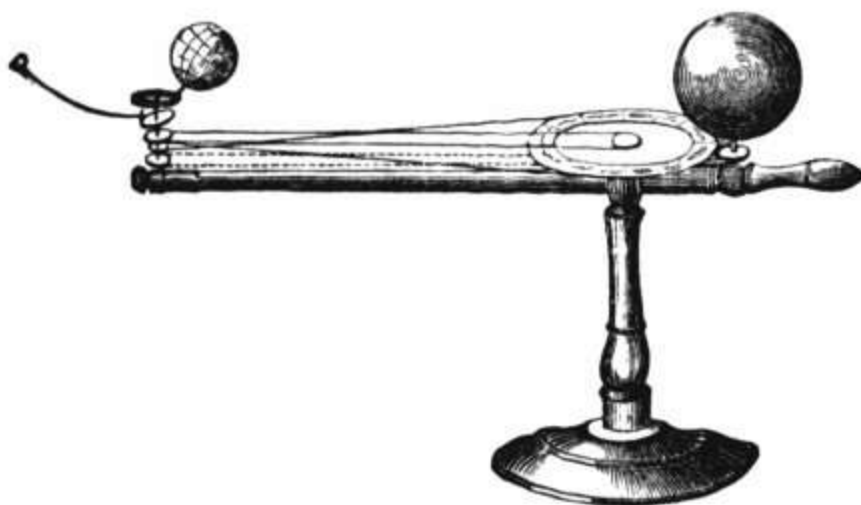

6713.

- |   |       |
|---|-------|
| 6713. <b>Tellurian</b> . Showing the rotation of the earth about the sun, and of the moon about the earth, the cause of eclipses, etc. Mahogany base and arm..... | 15 00 |
|---|-------|

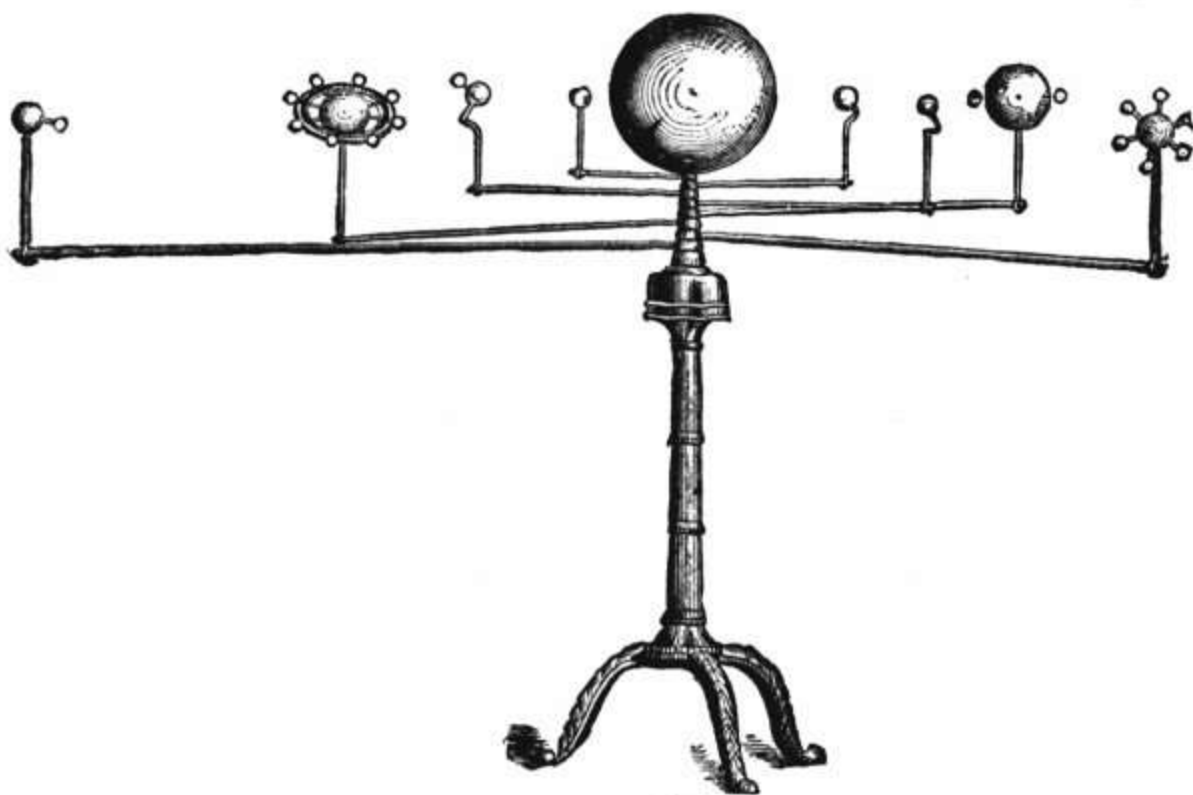

6714.

- |   |       |
|---|-------|
| 6714. <b>Planetarium with Brass Gearing</b> . Mounted on a neatly finished brass stand. The motion of the various planets around the sun is produced by a crank working upon cog-wheels connected with the bearings of the several planets..... | 18 00 |
|---|-------|



6715.

- |  | PRICE   |
|--|---------|
| 6715. <b>Planetarium, Large Model.</b> Containing all the planets (excepting the asteroids) yet discovered On fine polished brass stand, every part of the instrument carefully finished.....  | \$10 00 |
| 6716. <b>Whitall's Planisphere.</b> Showing the stars and constellations visible at any hour in the evening, for every night in the year. The most simple and satisfactory map of the heavens for the use of students and others extant. On strong card-board. 15 inches in diameter. Plain..... | 3 00    |
| 6717. Same as 6732. Colored.....   | 3 00    |
| 6718. <b>Whitall's Planisphere.</b> On glass for projection in lantern.....  | 10 00   |
| 6719. <b>Fine Terrestrial Globe,</b> 30 inches in diameter (4 feet, 3 inches high), mounted on a solid black walnut frame.....   | 275 00  |



6720.

# Auzoux's Elastic Anatomical Models.

AUZOUX'S ANATOMICAL MODELS are the Best, being composed of an entirely new material of great durability, and susceptible of a very high finish; the delicacy of detail they exhibit is truly admirable.

Complete Models of the MALE HUMAN BODY or MANIKIN, which can be readily dissected, in Stock and for sale at **very low prices.**

Other Models Imported to Order.

Explanations sent with each Model.

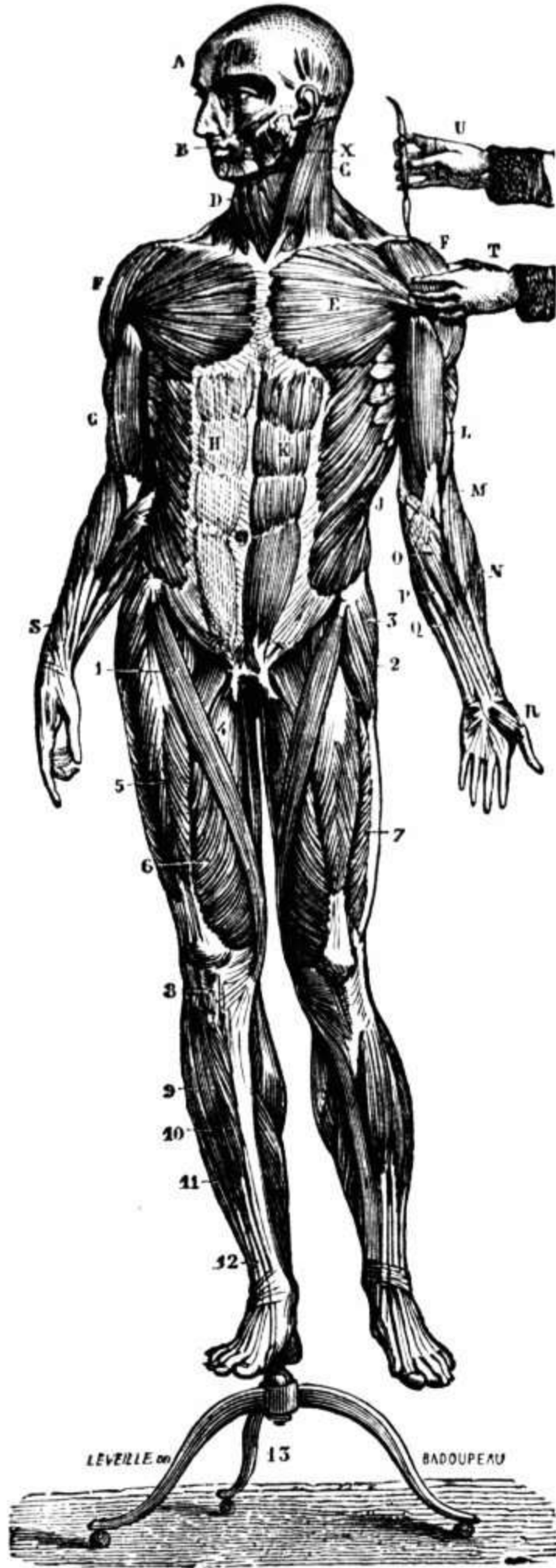

HUMAN SKELETONS, ETC., ETC.

GENERAL SUPPLIES FOR

PHYSICIANS, MEDICAL COLLEGES, SCHOOLS AND UNIVERSITIES.

BOCK STEGER ANATOMICAL MODELS



## CHAPTER IX.

## ANATOMICAL MODELS.

## SECTION I.—AUZOUX'S MODELS OF THE ANIMAL KINGDOM.

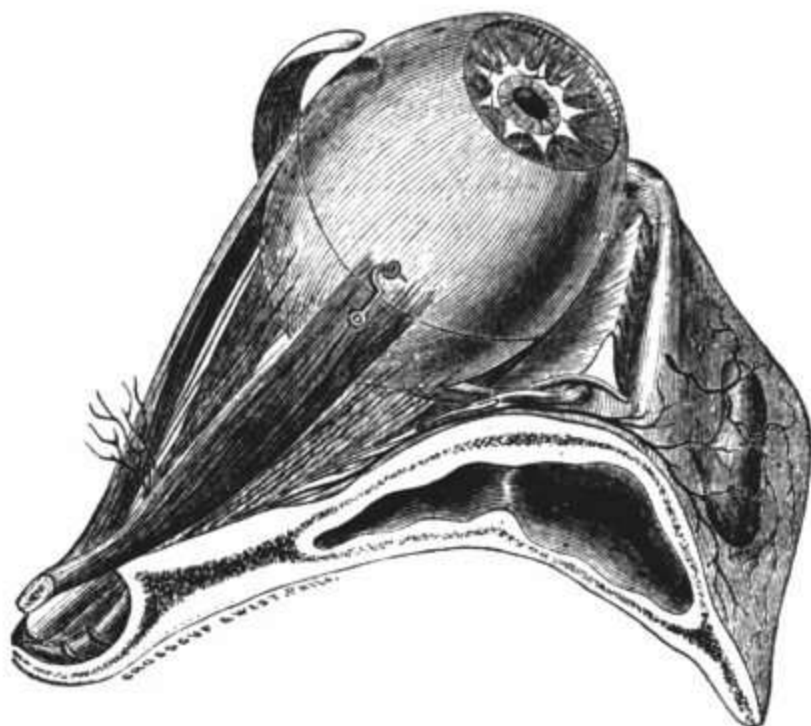

6761.

PRICE

6750. **Complete Model of Man.** Six feet high. Showing the muscles, blood-vessels, nerves, and the viscera; so arranged that they can be separately detached and examined. Two thousand distinct objects are shown in their proper position in the human frame. Sufficient to illustrate the most complete treatise on descriptive anatomy.....
6751. **Complete Model of Man.** Similar in all its details to No. 6750, but smaller, being only four feet high.....
6752. **Incomplete Model of Man.** Six feet high. Representing on one side the muscles, etc., of the superficial coats; on the other side the muscles, blood-vessels, and nerves of the deeper tissues; in other respects similar to the complete models, Nos. 6750 and 6751.....
6753. **Incomplete Model of Man.** Similar to No. 6752, but only four feet high.....
6754. **Model of Woman,** in the attitude and of the size of the *Venus de Medici*. Showing the muscles and tissues of the superficial coatings, and, on removing the front walls of the trunk, disclosing the various organs which fill the thoracic and abdominal cavities, their nerves, blood-vessels, and all the viscera. Each of these can be removed from its place and examined separately, as in an ordinary dissection.....
6755. **Ovology.** Development of the germ in the mammifers. Collection of more than twenty pieces, reproduced with great enlargement; showing the formation of the ovule in the ovary, its passage into the womb and its fecundation; permitting the changes to be followed at almost daily intervals from the first to the thirtieth day, that is, from the appearance of the ovule in the ovary until the formation of the embryo.....

Prices on application.

6756. **Egg of the Epiornis.** Natural size. Four sections permit the study of the various changes from the fresh egg to the complete development of the germ.....
6757. **Cerebrum, Cerebellum, Annular Protuberance and Spinal Bulb,** showing the details of the nervous system of man and the other vertebrata. ....
6758. **Cerebellum and Spinal Cord** in its whole length, with the origin of the spinal nerves, and the anterior and posterior ganglia.....
6759. **Dura Mater.** With a portion of the base of the skull, once and a half natural size, showing the whole extent, folds, sinuses, and the glands of Pachioni, etc.....
6760. **Adult Heart.** Divided into two halves, showing the disposition of the cavities, the muscular fibres, the arteries, nerves, the valves and the openings of the blood-vessels.....
6761. **Complete Eye.** Four inches in diameter, showing the muscles, blood-vessels, nerves, membranes, vitreous and crystalline humors, each part detachable at pleasure. Showing also the results of the most modern microscopic research upon the retina, the choroid coat and the iris.....
6762. **Complete Eye.** Cut vertically, with a portion of the orbit, showing the muscles, blood-vessels, nerves, membranes, humors, disposition of the anterior and posterior chambers, the conjunctiva, the structure of the eyelids, of the Meibomian glands, the tear glands and conduits, etc., as well as the microscopic results on the retina, etc.
6763. **Ear.** Sixteen inches across, showing the whole intricate detail of both the external and internal ear. Each piece detachable.....
6764. **Ear of a bird.** Greatly enlarged.....
6765. **Ear of a fish.** Greatly enlarged.....
6766. **Half Head.** Of large size, showing in all their delicate details the parts at the base of the brain, the divisions and ramifications of the fifth and seventh pair of nerves, the nervous ganglia, the eye, the ear, the nasal cavities, the mouth, the tongue, the pharynx and the larynx, with their muscles and blood-vessels.....
6767. **Larynx.** Once and a half natural size, showing the cartilages, muscles, blood-vessels and nerves.....
6768. **Larynx.** Same as preceding, but showing in addition, the tracheal artery and the division of the bronchiæ, to their last ramifications on entering the lung.....
6769. **Human Hand.** Once and a half natural size, with the muscles, tendons, blood-vessels, nerves, the corpuscles of Pacini, and a portion of the skin, with its different layers.....
6770. **Gorilla Troglodytes.** Five feet in height, showing the whole details separable, of its complete anatomy; viz., the bones, muscles, blood-vessels, nerves and viscera. Arranged just as in the complete model of man, No. 6750.....
6771. **Complete Horse.** Arab type. About four feet high. Complete anatomy, showing more than 3,000 details, in 97 separate pieces. Showing on one side, the muscles, nerves, and blood-vessels, of the superficial coats, which are not movable; on the other, the muscles, nerves, and blood-vessels, removable as in dissection, from the skin to the skeleton. In the cavity of the body are all the organs and viscera with which it is filled. These are removable at will.....
6772. **Incomplete Horse.** Showing on one side the muscles, nerves, and blood-vessels of the outer coatings; on the other, the muscles, nerves, and blood-vessels of the deep coatings only. The organs, etc., of the cavity, complete and removable, as in No. 6771.....
6773. **Jaws of the Horse.** Showing the age, at the different epochs of life. Collection of 30 different types.....

6774. **Jaws of the Ox.** Showing the age at the different epochs of life. Collection of 14 different types.....
6776. **Foot of the Horse.** Showing the hoof, the podophyllous tissue, and the cushion, with the blood-vessels, nerves, etc. Parts separable.
6777. **The Turkey.** Type of Birds. Complete anatomy, showing the respiratory apparatus, and the air-sacs of Dr. Sappey.....
6778. **Boa Constrictor.** Type of Reptiles, seven feet long. Complete anatomy.....
6779. **Head of Viper.** Much enlarged. Showing the fangs, muscles, glands, etc., of the poison apparatus.....
6780. **Sea-Perch.** Five and a half feet long. Type of fishes. Complete anatomy, showing muscles, nerves, blood-vessels, viscera, etc.....
6781. **Cockchafer.** (*Melolontha vulgaris*.) Type of insects in their perfect state. Twelve times natural size. Showing the muscles, tracheæ, nerves, and viscera. Each organ removable separately. The whole shows more than 600 details, indicated by numbers. Complete anatomy.....
6782. **Snail.** *Helix Pomatia* (Linn.). Type of mollusca, two feet long, showing the muscles, blood-vessels, nerves, and viscera. Each organ removable separately. Complete anatomy.....
6783. **Leech.** (*Hirudo Medicinalis*.) Type of Annelidæ, nearly two feet long. Showing the vascular, nervous, digestive, reproductive, and locomotive apparatus. Anatomy complete, and revised according to the latest researches.....
6784. **Silk-Worm.** Type of insect in the larva state. About two and a half feet long. Complete anatomy, showing the muscles, nerves, trachea, viscera, and the organ for the production of the silk.....
6785. **Honey-Bee.** Three and a quarter inches long, six different forms. Queen, drone, wax-worker, working bee, with bee bread and with pollen. These have all the exterior and interior characteristics of each type shown. Honey-comb, in same proportions, showing the cells for the honey, the pollen, the eggs for queens, for drones, and for working bees, with the eggs, larvæ, and nymphs of different age

## COMPARATIVE ANATOMY.

6786. **Comparative Anatomy.** A series of organs from man to the zoöphyte show the variation throughout the whole animal kingdom. Consisting of the organs of digestion, of respiration, of circulation, and of innervation in the mammals, birds, reptiles, fishes, insects, and molluscs. All greatly enlarged. Whole set.....

Separate parts of the collection No. 6786.

## 1. DIGESTION.

6787. **Stomach of the Lion**.....
6788. **Stomach of the Ruminant**.....
6789. **Stomach of the Horse**.....
6790. **Stomach of the Rodent**.....
6791. **Stomach of a grain-eating Bird**.....
6792. **Stomach of a Carnivorous Bird**.....
6793. **Stomach and Intestine of the Cuttle-fish**.....
6794. **Stomach and intestine of the Crab**.....
6795. **Stomach and intestine of a Polyp**.....
6796. **Stomach and intestine of a Grasshopper**.....
6797. **Stomach and intestine of the Honey-bee**.....

2. CIRCULATION.

PRICE

- 6798. **Heart and Blood-vessels of Human Fœtus**.....
- 6799. Heart and blood-vessels of **Crocodile**.....
- 6800. Heart and blood-vessels of **Serpent**.....
- 6801. Heart and blood-vessels of **Tortoise**.....
- 6802. Heart and blood-vessels of **Dugong**.....
- 6803. **Heart and Gills of the Carp**.....
- 6804. **Heart and Blood-vessels of the Oyster**.....
- 6805. Heart and blood-vessels of the **Gasteropods**.....
- 6806. Heart and blood-vessels of the **Cuttle-fish**.....
- 6807. Heart and blood-vessels of the **Muscle**.....
- 6808. **Heart and Trachea of Insect**.....

3. NERVES.

- 6809. **Brain and Spinal Cord of Man**.....
- 6810. **Brain of the Cat**.....
- 6811. Brain of the **Rat**.....
- 6812. Brain of the **Goose**.....
- 6813. Brain of the **Viper**.....
- 6814. Brain of the **Tortoise**.....
- 6815. Brain of the **Carp**.....
- 6816. Brain of the **Ray**.....
- 6817. **Nerve System of the mollusca**.....
- 6818. Nerve system of the *radiata*.....
- 6819. Nerve system of the *arachnidæ*.....
- 6820. Nerve system of the *crab*.....
- 6821. Nerve system of the *articulata*, in the state of larva, of chrysalis and perfect insect.....

4. RESPIRATION.

- 6822. **Of Birds**. Showing larynx, tracheal artery and lungs, with the air sacs.
- 6823. **Of Reptiles**, lungs of the frog.....
- 6824. **Of Insects**, trachea and heart.....

5 CRANIOLOGY.

- 6825. **Human Head of an Idiot**. { Skull...\$ } .....
- 6826. **Human Head**, excessively large. { Skull...\$ } .....
- 6827. **Head of Young Gorilla**. { Skull as yet without bony ridges.\$ } .....
- 6828. **Head of Adult Gorilla**. { Skull with commencement of bony ridges .....\$ } .....
- 6829. **Head of Old Gorilla**. { Skull with bony ridges, very strongly marked.....\$ } .....
- 6830. **Head of Female Gorilla, Young**. { Skull without ridges....\$ } .....
- 6831. **Head of Female Gorilla, Old**. { Skull without ridges....\$ } .....
- 6832. **Head of Chimpanzee**. { Skull...\$ } .....
- 6833. **Head of the Orang-Outang**. { Skull...\$ } .....

6834. Head of the <b>Gibbon.</b>	{ Skull....\$ Brain... }	.....
6835. Head of the <b>Seal.</b>	{ Skull....\$ Brain... }	.....
6836. Head of the <b>Lion.</b>	{ Skull....\$ Brain... }	.....
6837. Head of the <b>Panther.</b>		.....
6838. Head of the <b>Deer.</b>		.....
6839. Head of the <b>Wolf.</b>		.....
6840. Head of the <b>Horse.</b>		.....
6841. Skull of the <b>Elephant.</b>	Dividing into two parts, with jaws and tusks, and showing the numerous cellules which limit the cerebral cavity.....	
6842. Brain of the <b>Elephant.</b>	Parts so made as to show the internal structure, and to be placed in their proper cavities in the skull, No. 6841.	
6843. Head of the <b>Kangaroo.</b>	{ Skull....\$ Brain... }	.....
6844. Head of the <b>Sea-Hog.</b>	{ Skull....\$ Brain... }	.....
6845. Head of the <b>Crocodile.</b>	{ Head....\$ Brain.... }	.....

## SECTION II.—ANATOMY OF THE VEGETABLE KINGDOM.

These models are all made ten times the natural size of the object they represent. Each part can be taken off separately, and thus allows a careful and detailed examination of the sepal, the petal, the stamen, the anther, the carpel, the ovule, etc., in the different phases of flowering, growth, and germination.

6850. **Wall Flower** (*Cheiranthus cheiri*). Stem, leaves, and flowers of different degrees of development, complete flower and fruit in state of maturity, showing the two carpels.....
6851. Flower alone.....
6852. **Silique**.....
6853. **Pink** (*Dianthus caryophyllus*). Stem, leaves, stipule, bracts, with perfect flower and mature fruit.....
6854. Flower alone.....
6855. **Fruit**.....
6856. **Pea** (*Pisum sativum*). Stem, leaves, stipules, tendrils, flowers, before and after flowering.....
6857. Flower alone.....
6858. **Pod greatly enlarged.** Showing the structure of the carpellary leaves, with a series of ovules, in different stages of growth.....
6859. **Pod Approaching Maturity.** Showing the pea, the envelopes, the dicotyledonous mass, and the embryo.....
6860. **Hare-Bell** (*Campanula ranunculus*). Complete flower.....
6861. **Snap-Dragon** (*Antirrhinum majus*). Stem, stipules, flowers, before and during flowering, ovary in mature state, dehiscent.....
6862. Flower alone.....
6863. **Fruit**.....
6864. **Chrysanthemum** (*Chrysanthemum coronarium*). Stem, leaves, flowers, before and during flowering, capable of division into two masses, and receptacle with seeds.....

6865. **Chrysanthemum.** Flower alone.....
6866. Receptacle with seeds.....
6867. **Sorrel** (*Rumex patientia*). Flower alone, with bracts, calyx, stamen, pistil and ovary.....
6868. **Sorrel.** Ripe seed, with dicotyledonous mass in which one may see the embryo.....
6869. **Bittersweet** (*Solanum dulcamara*). Complete flower.....
6870. **Deadly Night-Shade** (*Atropa belladonna*). Complete flower.....
6871. **Deadly Night-shade.** Ripe fruit, with calyx cut transversely to show the disposition of the carpellary leaves and seeds.....
6872. **Henbane**, (*Hyoscyamus niger*). Fruit separable into calyx and capsule, and showing by sections the mode of opening, when ripe....
6873. **Fuchsia.** Stem, leaves, flowers, before and during inflorescence; a complete flower and a berry, permitting an inspection of the carpellary leaves, and the fruit.....
6874. Flower alone.....
6875. **Berry**.....
6876. **Columbine** (*Aquilegia vulgaris*). Fruit whose carpels can be detached, showing the attachment of the seed to the placentæ.....
6877. **Fruit of the Yew** (*Taxus baccata*). Opening to show the ovule.....
6878. **Grain of Wheat.** Thirty times the natural size, consisting of its husks, the embryonic coat, the farinaceous mass, the embryo and its parts, which one can take out and replace by another embryo, beginning to develop by germination, showing the constituents of the young plant.....
6879. **Acorn.** With its capsule, envelopes, the dicotyledonous mass and the embryo.....
6880. **Acorn.** Without its envelopes, showing the two cotyledons opening and disclosing the embryo, so far progressed in germination as to have its little leaves and its root and rootlets.....
6881. **Acorn, ripe.** Showing the different coats of the pericarp, and the ovule with its envelopes.....
6882. **Wood.** Fragment of the woody stem of a dicotyledon (*quercus communis*), of three years' growth, greatly enlarged, showing, in the solid wood, the pith, the spiral vessels, the medullary sheath, the medullary rays, the composition of the woody fibres, the vascular, annular and dotted ducts, the open spaces, the heart wood and sap wood, and the cambium layer; in the bark, the liber, the cellular envelope, and the epidermis, which are each removable; and the sap vessels and wood fibre.....
6883. **Strawberry.** Cut vertically to show the development of the receptacle, holding in its parenchyma the numerous seeds or akenes.....
6884. **Mulberry** (*Morus nigra*). Cut vertically, showing several simple seeds surrounded with floral envelopes becoming succulent.....
6885. **Comfrey** (*Symphytum officinale*). Complete flower.....
6886. **Melon** (*Cucumis melo*). Male flower complete.....
6887. **Melon.** Female flower complete, with sections made in the ovary, to show the disposition of the carpels and ovules.....
6888. **Moss.** Flower of the common.....
6889. Collection of thirty-six pieces of flowers and fruits, with woody fibre, No. 6882.....

**BOCK-STEGER ANATOMICAL MODELS OF THE HUMAN BODY.**

MOUNTED ON STANDS AND PAINTED IN NATURAL COLORS.

These models are of very moderate price and great excellence of workmanship and design.

Their unsurpassed usefulness as a means of instruction in Anatomy and Physiology has been universally acknowledged. They are made of a hard composition of plaster of paris, after the models of Dr. Bock and other physiologists. We have widely introduced them into the educational institutions of the country.

The low prices at which we furnish these models bring them within the reach of all schools and medical students.

We keep a large stock on hand. Each genuine model bears the stamp, "Bock-Steger."

**MODELS REPRESENTED IN GREATLY ENLARGED SIZE.**

No.	PRICE.
1. THE HEART, the anterior wall of which can be removed, disclosing the four cavities of the heart, with their openings and valves.....	\$8 00
2. THE EYEBALL, the upper portion of which (containing a microscopical representation of the layers of the retina) is to be taken off, when the cornea and iris, the lens and the vitreous body may be taken out.....	6 50
3. THE ORGAN OF HEARING, containing in separate parts the membrana tympani, the ossicles of the tympanum, the labyrinth, and the half-opened cochlea.....	8 00
4. THE SKIN, showing, in a transverse section, the organs of perspiration, a hair with its follicles, the pulp, the sebaceous glands, and tactile corpuscles.....	4 00
5. THE TEETH, the anterior portion of the left maxillary bone being removed for the purpose of showing their development and structure.....	4 00

**MODELS OF NATURAL SIZE.**

6. THE BRAIN, in four different aspects:	
A. View of <i>Upper Portion</i> .....	\$3 50
B. View of <i>Lower Portion</i> (basis of cerebral nerves).....	3 50
C. <i>Perpendicular Section</i> along the median line.....	3 50
D. <i>Transverse Section</i> , showing the cavities.....	3 50
7. THE HEAD. Three views:	
A. Head with <i>Muscles, Nerves and Blood-vessels</i> of one side.....	6 00
B. Head with <i>Cavities of the Skull and Eye, Upper and Lower Jaw</i> .....	6 00
C. <i>Perpendicular Section</i> of the head, showing the brain, cavities of the mouth and nose, larynx and pharynx, divided along the median line.....	6 00
8. THE LUNGS, with the Heart.	
A. <i>Anterior view</i> of the lungs and heart, the pericardium opened. The anterior portion of the left lung is removed, showing the <i>Bronchial Ramifications</i> .....	4 00
B. <i>Posterior view</i> of the lungs and heart, with a representation of the bronchial rami, air-cells and blood-vessels.....	4 00
9. THE ORGANS OF RESPIRATION. <i>Air-Passages, Lungs, Heart.</i> The anterior part of both lungs with the heart can be taken off, laying open the ramifications of the wind-pipe within the lungs. The connection of the pulmonary blood-vessels with the heart.....	12 00
10. THE LARYNX (viewed anteriorly and posteriorly):	
A. <i>Anterior aspect</i> with the hyoidean os and the thyroid gland.....	2 50
B. <i>Posterior aspect</i> with the glottis and vocal cords.....	2 50
C. Larynx in connection with the <i>Tongue and Pharynx</i> , which latter is opened from behind..	3 50

No.	PRICE.
11. THE JOINTS, partially opened, with their bones and ligaments :	
A. Arm-joint of the shoulder, opened.....	\$2 50
B. Elbow-joint, a, anterior view.....	2 00
C. Elbow-joint, b, lateral view. ....	2 00
D. Wrist-joints and Hand.....	3 00
E. Hip-joint .....	2 50
F. Knee-joint.....	2 50
G. Ankle-joints and Foot.....	4 00
12. THE TRUNK (Torso) with the viscera of chest and abdomen laid open....	30 00
<i>Latest additions:</i>	
13. The human SKULL and BRAINS, the various parts of which can be taken out.....	12 00
14. The LARYNX PHANTOM. Mask of the face, mouth open, for the purpose of practicing with the Laryngoscope.....	10 00
A COMPLETE SET OF 23 MODELS, PACKING AND SHIPPING INCLUDED, \$150. For single Models, packing-boxes charged at cost.	

### NEW BOCK-STEGER MODELS.

6900a. HUMAN HEART, similar to No. 6900, but smaller.....	\$5 50
6901a. " EYEBALL, similar to No. 6901, but smaller.....	5 00
6902a. " EAR, similar to No. 6902, but smaller.....	6 50
6935. MODEL OF ARM, natural size, neatly mounted on wood stand, showing upper layer of muscles.....	15 00
6936. MODEL OF ARM, similar to No. 6935, but showing the under layer of muscles.....	15 00
6937. MODEL OF LEG, natural size, mounted on neat wood stand, showing the upper layer of muscles, beautifully colored.....	18 00
6938. MODEL OF LEG, similar to No. 6937, but showing under layer of muscles .....	18 00

DIXON, CAL., May 26th, 1882.

Messrs. Jas. W. Queen & Co., 924 Chestnut Street, Philadelphia.

DEAR SIR: The Physiological models came three days ago in excellent condition. We, and many others who have seen them, are delighted with them. They are pronounced to be marvels of workmanship and design.

I feel inclined to write an article calling attention to them and the manner of getting them for the *California School Journal*. I think many other schools would like to get the same apparatus on the same terms.

Yours truly,

J. T. WALLACE.

ELMIRA, October 20th, 1882.

James W. Queen & Co.,

DEAR SIR:—I have read the lists of apparatus you were so kind as to send me. They seem eminently adapted to the purpose intended and advertised. The only criticism I have is upon some pieces, like the model screw, for example, the price of which might, in my judgment, better be applied to something more novel—perhaps in purchasing a better set of pulleys and weights. Perhaps, however, my judgment is founded upon my own plan of making in class so many pieces of apparatus. I know the majority of teachers have neither the wish nor the time to do this, and many would not even take the trouble to get a common iron screw to show a class and explain its complex principles. Wishing you great success in selling this improved apparatus, as it is in so many respects, I am

Sincerely yours,

J. DORMAN STEELE.



## HUMAN SKELETONS, ETC.

We furnish the best French and American Preparations.

The prices of Skeletons vary with the character of the development of the bones, their degrees of hardness and whiteness, and the amount of fat contained in their extremities. We are prepared to furnish all kinds of Skeletons, both illustrating Human Osteology and that of Animals.

No	PRICE.
1. Skeleton, articulated with wires, . . . . .	\$35 00
2. Do. do. do. medium quality, . . . . .	42 00
3. Do. do. do. fine quality, . . . . .	50 00
4. Do. do. do. extra fine quality, . . . . .	\$55 00 and 60 00
4a Skeletons, disarticulated, in boxes, best French, . . . . .	50 00

These are the best French Skeletons, are well bleached and cleansed, very carefully articulated, and furnished with brass ring for suspension.

5. Half Skeletons, disarticulated, in boxes; consisting of the skull, spinal column, twelve ribs, sacrum, one os innominatum, one arm and one leg, hand and foot; the latter two and the vertebræ are held together by catgut, . . . . .	21 50
--	-------

These consist of bones of second quality.

6. Skeletons, articulated, with the bones separated (Beauchène's method), with support in copper, pedestal of polished oak, on rollers, \$150 00—\$200 00	
7. Foetal Skeletons, . . . . .	15 00
8. Skulls, disarticulated, in boxes, with apartments for each bone, \$14.00, \$16.00, \$18.00, according to quality.	
9. Entire Skulls, articulated, . . . . .	\$6 50 to 10 00
10. Do. do. with horizontal section, . . . . .	9 50
11. Do. do. two sections, one horizontal, one vertical, . . . . .	12 00
12. Heads, divided by 5 sections, showing the nasal fossæ and sinus, . . . . .	18 00
13. Do. do. 7 do. do. sinus; the temporal bones disarticulating to show the middle and internal ear, . . . . .	27 50
14. Hands or feet, the bones strung upon catgut, each . . . . .	3 50
15. Articulated female pelvis, with ligaments and foetal skull, . . . . .	14 00
16. Skeleton of the Horse, articulated, . . . . .	130 00

NOTE.—Skeletons Nos. 1, 2 and 3 we would highly recommend for schools.

Skeletons should not be exposed to the light when not in use, as they are liable to become yellow.

## CHAPTER X

## BALANCES OF PRECISION

## ANALYTICAL AND ASSAY BALANCES, "TROEMNER'S."

*We specially recommend these balances. They are in general use at the United States Treasury, and by all the United States Mints and Assay Offices; also by the Canadian and Chilean Governments, and the first Colleges and Universities in the country.*

- |  | PRICE    |
|--|----------|
| <p>6940. <b>Analytical Balances.</b> This instrument is intended for scientific research, and combines, in the highest possible degree, all the conditions of sensibility, accuracy and constancy attainable. The beam is German silver, 18 inches long, and is divided into <math>\frac{1}{10}</math> milligrammes, for use with rider. This instrument with one kilogramme in each pan, is sensible to one milligramme or to one millionth of the load. Mounted in polished mahogany case, with counterpoised sliding glass doors, the instrument is thus protected from injurious vapors and gases found in almost every physical laboratory. Price, without weights.....</p> | \$150 00 |

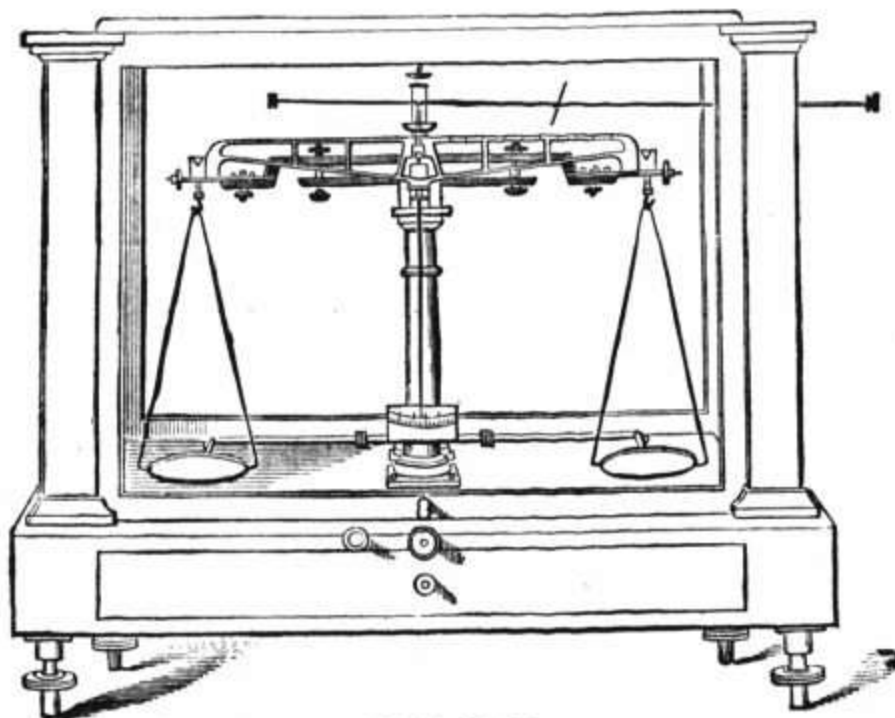

6941-6943.

- |   |        |
|---|--------|
| <p>6941. Analytical Balance, capacity 200 grammes in each pan, sensible to <math>\frac{1}{20}</math> milligramme, mounted in fine polished glass case; finish similar to 6940. Beam of German silver, 14 inches long; divided into <math>\frac{1}{10}</math> milligramme, for use with rider; all agate bearings, with improved arrest for pans, with specific gravity apparatus, etc., complete. Price, without weights.....</p> | 105 00 |
| <p>6942. Analytical Balance, capacity 100 grammes in each pan, sensible to <math>\frac{1}{10}</math> milligramme; German silver beam 12 inches long, divided in one-half parts of milligrammes; all agate bearings, similar finish to No. 6941.....</p>   | 86 00  |

BALANCES.

209

PRICE

6943. Analytical Balance, capacity 2000 grains; sensible to  $\frac{1}{100}$  of a grain; brass beam 10 inches long, with fine steel bearings; movable  $3\frac{1}{2}$ -inch pans, set screws, spirit-level, etc. Price, without weights. \$40 00
6944. Same balance as No. 6943, has attachment for rider, and pan arrests. Beam graduated to one milligramme..... 50 00

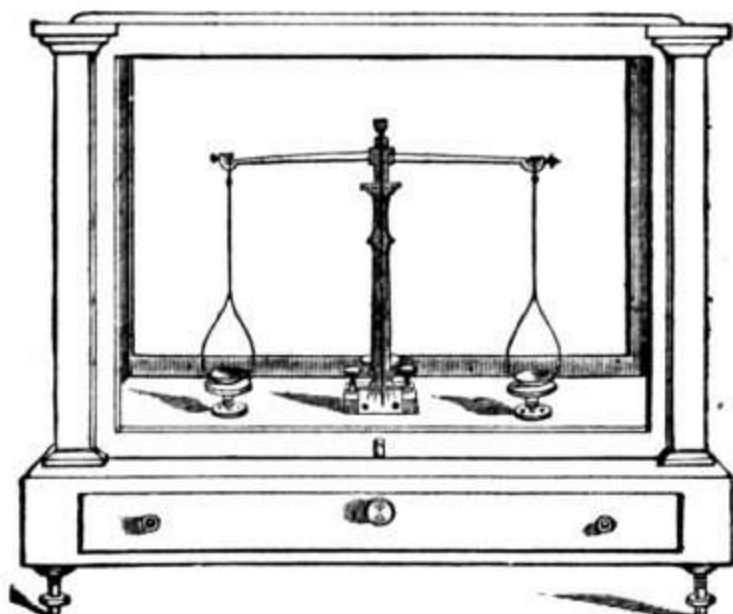

6945-6946.

6945. **Assay Balances.** In French polished glass case, beam resting on agate bearings. Sensible to  $\frac{1}{20}$  milligramme..... 55 00
6946. Balance of the very finest construction, in mahogany case with sliding doors, arranged with rider apparatus, beam being divided into  $\frac{1}{10}$  milligrammes; all bearings of agate, with adjustable pan arrests. Needle deviates 10 full divisions on ivory scale for 1 milligramme. 80 00

ANALYTICAL BALANCES.

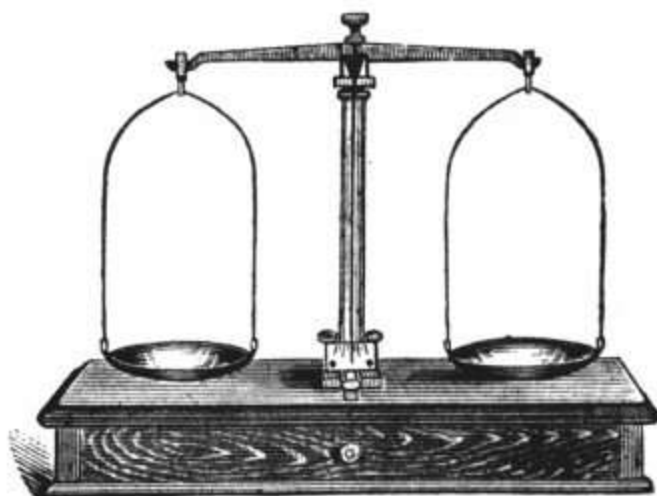

6947-6949.

For weighing Ores, Minerals, Gold and Silver Coin, Jewelry, Chemicals, etc., etc.

On fine polished mahogany box, with drawer. Lacquered beam, with box ends, adjusting screws, movable pans, ivory indicator; sensible to  $\frac{1}{20}$  grain. Price does not include weights.

No.	Length of Beam	Diameter of Pans.	Capacity.	
6947.	14 inches.....	6 inches.....	25 oz.....	\$24 00
6948.....	10 " .....	4 $\frac{1}{2}$ " .....	16 " .....	18 00
6949.....	8 $\frac{1}{2}$ " .....	3 " .....	8 " .....	15 00

Pans can be suspended by chains if desired.



6950-6955.

No.	Length of Beam.	Diam. of Pans.	Marble Column.	Brass Column.	Iron Column.
6950	20 inches	11 inches	\$42 00	\$25 00	\$20 00
6951	18 "	10 "	37 00	22 00	18 00
6952	16 "	9 "	32 00	20 00	16 00
6953	14 "	8 "	28 00	18 00	14 00
6954	12 "	7 "		16 00	12 00
6955	10 "	6 "		14 00	10 00



6956-6957.

	PRICE
6956. Balance for General Weighing, capacity 1 ounce to 4 lbs., without weights.....	\$3 75
6957. Do. smaller size, with weights from 1 ounce to 2 lbs.....	2 00



6958-6959.

	PRICE
Balance. Brass mounting on a mahogany box, with weights.	
6958. Beam, 7½ inches.....	5 50
6959. " 5½ " .....	4 00

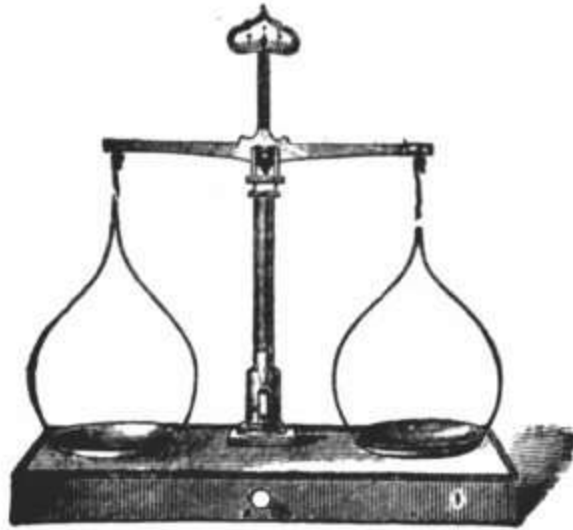

6960-6962.

On polished box, with drop lever, especially constructed for laboratory use. Including weights.

No.	Diameter of Pan.	Beam.	Capacity.	PRICE
6960.....	5 inches.....	9 inches.....	32 oz.....	\$15 00
6961.....	4 ".....	8 ".....	16 ".....	12 00
6962.....	3 ".....	7 ".....	8 ".....	10 00

Pans can be suspended by chains if desired.

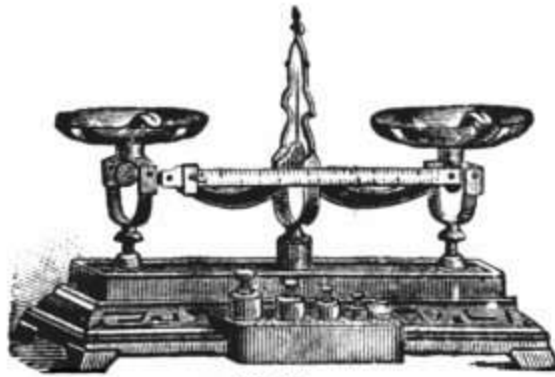

6963.

6963. Handsomely finished Scales, with 3½-inch movable nickel-plated pans. Side beam on front of Scale, with sliding weight. Beam is divided into 120 divisions, each division representing one grain—an extra row of metric divisions is placed on the bottom edge of beam, each representing one centigramme. Platform or shelf is attached to base of scale, in which are fitted separately a set of solid brass weights, 2 oz. down.....

9 00

Gramme instead of troy weights will be furnished when desired.

ROBERVAHL SCALES.



6964-6966.

No.	Diameter of Pans.	Capacity.	
6964.....	10 inches.....	15 lbs.....	10 00
6965.....	8 ".....	10 ".....	8 00
6966.....	6 ".....	5 ".....	6 00

## STUDENTS' BALANCE.

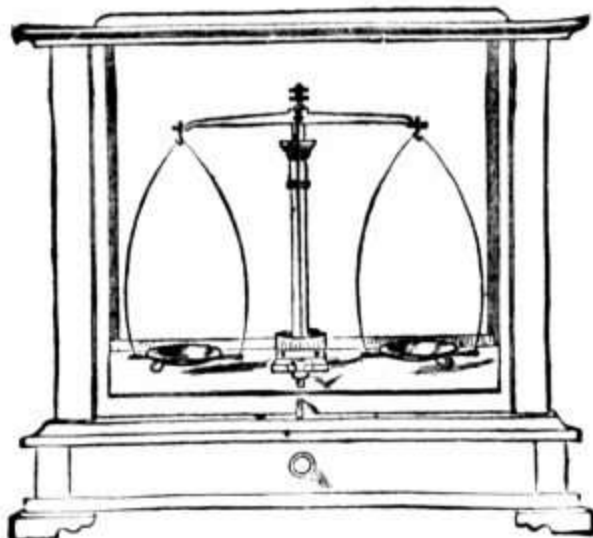

6967.

6967. In polished mahogany case. Counter poised doors, sliding upward. Scale has  $8\frac{1}{4}$ -inch beam,  $2\frac{1}{2}$ -inch nickel pans, and is sensible to  $\frac{1}{50}$  grain. Being specially adapted to delicate weighing, such as poisons, etc., etc.....

PRICE

\$24 00

## SPECIFIC GRAVITY SCALE.



6968.

6968. Constructed after the plan of Dr. Mohr. Price, complete..... 20 00

WEIGHTS OF PRECISION.



6969.

In fine velvet lined polished block. Weights lacquered and adjusted with the greatest care and precision.

No. 6969.		PRICE
1	Platinum gramme to 1 milli.....	\$7 50
1	" " $\frac{1}{10}$ " .....	8 00
10	Grammes to 1 milli.....	9 00
10	" $\frac{1}{10}$ " .....	9 50
20	Grammes to 1 milli.....	10 00
50	" 1 " 3 riders .....	12 50
100	" " " .....	14 00
200	" $\frac{1}{10}$ " " .....	13 00
500	" 1 " .....	18 00
	Gold assay weights.....	8 00

All riders weigh 10 milli., unless otherwise ordered.

No. 6970.		GRAINS.	
10	Platinum grains to $\frac{1}{10}$ grain.....		5 00
10	" " $\frac{1}{100}$ " .....		7 00
10	" " $\frac{1}{1000}$ " .....		7 50
100	Grains to $\frac{1}{100}$ grain.....		8 50
1000	" $\frac{1}{10}$ grain, 3 riders.....		10 50
1000	" $\frac{1}{100}$ " " .....		11 00
1000	" $\frac{1}{1000}$ " " .....		12 00
	4 oz. troy to $\frac{1}{10}$ " .....		8 00
	Assay ton weights, $\frac{1}{4}$ A. T. to $\frac{1}{20}$ A. T.....		6 50

GRAMME WEIGHTS.

No. 6971.		In Mahogany Block.	
20	Gramme to 1 centigramme.....		3 50
100	" " " .....		6 00
500	Grammes to 1 Gramme.....		8 00
500	" " centi.....		10 00
500	" " milli .....		12 00
1	Kilo. to 1 gramme.....		10 00
1	" " centi.....		12 00
1	" " milli.....		14 00
1	oz. troy to $\frac{1}{10}$ grain.....		4 00
2	" " " .....		5 00
5	" " " .....		7 50
10	" " " .....		10 00

TROY CUP WEIGHT.

(Accurate.)



6972.

No. 6972.		
32	oz. down.....	5 00
16	" .....	4 00
8	" .....	3 50
4	" .....	1 50
10	Pennyweight to $\frac{1}{2}$ grain.....	75

ALUMINIUM GRAIN WEIGHTS.



6973.

No. 6973.

$\frac{1}{2}$ to 5 grains per set.....	PRICE
Per doz. set.....	50

SQUARE ALUMINIUM GRAIN WEIGHTS



6974.

No. 6974.

$\frac{1}{2}$ to 10 grains, per set.....	50
Per doz. set.....	

BRASS BLOCK WEIGHTS.—AVOIRDUPOIS.



6975.

In Oiled Walnut Block, thoroughly finished and accurately adjusted.

No. 6975.	Brass.	Nickel Plated.
1 lb to $\frac{1}{4}$ ounce.....	\$4 50	\$6 00
2 " $\frac{1}{4}$ " .....	6 00	8 00
4 " $\frac{1}{4}$ " .....	8 00	10 00

NEST WEIGHTS.—AVOIRDUPOIS.

Very accurately adjusted.



6976.

No. 6976.	Solid Brass.	Solid Zinc.	Sealed Iron.
1 lb to $\frac{1}{4}$ ounce.....	\$3 00	\$2 00	\$0 50
2 " $\frac{1}{4}$ " .....	5 00	3 00	75
4 " $\frac{1}{4}$ " .....	8 00	4 50	1 25

Our zincs and solid brass weights are of the finest finish, and cast from new metal of the best quality.



## CHAPTER XI

## CHEMICAL APPARATUS.

## 2. APPARATUS FOR THE MANUFACTURE OF GASES, &amp;C.

7000. Apparatus for the manufacture of Oxygen from the chlorate of potash and binoxide of manganese. Consisting of a copper bottle of over a quart capacity, with lead pipe of large calibre, fitted to it by a ground joint (thus dispensing with the objectionable gallews screw arrangement); and passing at the other end by a screw coupling to a strong wash bottle, for washing. Six feet of rubber tubing, with connector, lead the gas from the wash bottle. Complete . . .	12 50
7001. Copper Retort of No. 7000 . . . . .	4 50
7002. Copper Retort and Lead Pipe of No. 7000 . . . . .	6 00
7003. Wash Bottle of No. 7000 . . . . .	4 00
7004. Apparatus for the manufacture of Oxygen from the chlorate of potash. Consisting of a strong iron basin-shaped vessel, holding a gallon or more, with feeding arrangement cover, and iron exit pipe $1\frac{1}{2}$ inch in diameter. For the manufacture of large quantities of gas . . . . .	25 00
7006. Apparatus for the manufacture of Hydrogen. Glass jar, holding one gallon, with top, inverted bell, support for zinc and stop-cock . . . . .	7 00
7007. Dobereiner's Lamp. Same as No. 7006, but with the addition of a jet and holder for platinum sponge, with sponge . . . . .	9 00
7008. Dobereiner's Lamp. Small model . . . . .	5 00
7009. Attachment to No. 7006, for the production of musical sound. Consisting of a brass jet 11 inches long, and three tubes of different length . . . . .	2 50
7010. Apparatus for the manufacture of Hydrogen. Consisting of a copper tank with floating cistern seven inches in diameter and thirteen inches deep, with false bottom to hold the zinc. Copper exit pipe leading to a strong wash-bottle. Without wash-bottle . . . . .	20 00
7011. With wash-bottle . . . . .	24 00
7012. Automatic Apparatus for the manufacture of Hydrogen in large quantities. Consisting of a heavy copper tank with handles, a floating cistern of copper eleven inches in diameter and twenty-six inches deep, with false bottom to hold the zinc. Sponge-absorber, and copper exit pipe leading to a strong wash-bottle. Without wash-bottle . . . . .	40 00
7013. No. 7012, with wash-bottle . . . . .	44 00
7018. India-Rubber Bag, oval, best quality, for storing oxygen or hydrogen, with stop-cock, 1 gallon . . . . .	2 25
7019. India-Rubber Bag, oval, best quality, for storing oxygen or hydrogen, with stop-cock, 2 gallons . . . . .	2 75
7020. India-Rubber Bag, oval, best quality, for storing oxygen or hydrogen, with stop-cock, 3 gallons . . . . .	3 00
7021. Brass Stop-cock, for Nos. 7018-7024 . . . . .	1 00

	PRICE
7021. India-Rubber Bag, oval, best quality, for storing oxygen or hydrogen, with stop-cock, 5 gallons.....	\$3 75
7022. India-Rubber Bag, oval, best quality, for storing oxygen or hydrogen, with stop-cock, 6 gallons.....	4 00
7023. India-Rubber Bag, oval, best quality, for storing oxygen or hydrogen, with stop-cock, 8 gallons.....	5 00
7024. India-Rubber Bag, oval, best quality, for storing oxygen or hydrogen, with stop-cock, 10 gallons.....	6 00
7025. Mouth-piece attachment.....	75
7026. Bubble-tube attachment.....	1 00
7028. <b>India-Rubber Bag</b> , 24 inches by 30.....	9 50
7029. India-Rubber Bag, 30 inches by 40.....	11 50
7030. India-Rubber Bag, 30 inches by 40, very superior.....	18 00
7031. <b>Hydrogen Balloons</b> of French rubber. Each.....	50
7032. Hydrogen Balloons of French rubber, large size. Each.....	1 50
7033. Hydrogen Balloons of Gold-beaters' skin. Each.....	2 50
7034. Hydrogen Balloons of Collodion. Each.....	1 00
7040. <b>Gasometers.</b> Pair of copper, neatly japanned, with floating bells 10 inches by 30. Mounted on base with castors, with the balance-weights enclosed in tubes at each side.....	100 00
7041. Gasometers. Pair of galvanized iron, on strong oak frame, with guides, balance-weights, and outlet stop-cock. The floating bells are 30 inches in diameter by 40 inches high, and the top is strengthened by a wooden cover to allow of adding weights if desired, and is also surmounted by a cylindrical extension to contain sand in the absence of weights. Per pair.....	125 00
7042. Gasometer. Similar to those in No. 7041, but 36 inches in diameter by 72 inches high, for storing large quantities of gas. Each.....	100 00
7043. <b>Hydro-oxygen Blow-Pipe.</b> For deflagrating metals. Very strongly made, and substantially mounted.....	15 00

### 3. MISCELLANEOUS CHEMICAL APPARATUS.

7044. <b>Phosphorus Cup.</b> On stand to place under receiver in obtaining nitrogen.....	75
7045. <b>Eudiometer.</b> Bunsen's.....	3 50
7046. Eudiometer. Ure's, straight.....	2 00
7047. Eudiometer. Ure's, U form.....	3 00
7048. Eudiometer. Hoffmann's, V form on stand.....	5 00
7049. Eudiometer. Hoffmann's, V form on stand, large model.....	15 00
7050. <b>Atomizing Tubes.</b> Each.....	25
7051. <b>Arsenical Test Apparatus.</b> Marsh's. Complete and mounted.....	2 50
7052. Arsenical Test Apparatus. Fresenius'.....	1 00
7053. Arsenical Test Apparatus. Mitscherlich's.....	3 00
7054. <b>Apparatus</b> for the Manufacture of Carbonic Acid. Consisting of a gallon receiver with closed top, containing an inverted bell-glass, and lead dish, and furnished with stop-cock.....	7 00
7055. <b>Monochromatic Light.</b> Complete.....	12 00
7075. <b>Glass Beakers</b> , common form, in nests of 4; up to 4 oz.....	35
7076. Glass Beakers, common form, in nests of 6; up to 16 oz.....	1 00
7077. Glass Beakers, common form, in nests of 9; up to 48 oz.....	2 50
7078. Glass Beakers, common form, in nests of 12; up to 140 oz.....	4 00
7079. Glass Beakers, tall form, set of 8.....	3 50
With lips, 10 per cent. additional.	
Large gas stop-cock for Nos. 7028, 7029 and 7030.....	1 75

	PRICES
7080. <b>Blow-Pipe</b> , jewelers' form.....	\$0 25
7081. Blow-Pipe, with bulb.....	75
7082. Blow-Pipe, Berzelius'.....	2 00
7083. Blow-Pipe, Plattner's, most perfect form.....	2 00
7084. Blow-Pipe, Berzelius', nickel-plated.....	2 50
7085. Blow-Pipe, Plattner's, nickel-plated.....	2 50
7086. <b>Bolt Heads</b> , pint size.....	75
7087. Bolt Heads, quart size.....	1 00
7088. <b>Liebig's Condenser</b> , of glass, mounted.....	3 00
7089. Liebig's Condenser, of japanned tin.....	6 00
7090. Liebig's Condenser, of brass.....	8 00
7100. <b>Cork-Borers</b> , set of 3 of brass.....	75
7101. Cork-Borers, set of 6 of brass.....	1 75
7102. Cork-Borers, set of 12 of brass.....	3 75
7103. <b>Crucibles</b> , Hessian, per nest of 5, from $\frac{1}{2}$ oz. to 8 oz.....	15
7104. Crucibles, Hessian, per nest of 5, from 2 oz. to 1 qt.....	35
7105. Crucibles, Plumbago, 4 oz.....	15
7106. Crucibles, Plumbago, 6 oz.....	20
7107. Crucibles, Plumbago, 8 oz.....	25
7108. Crucibles, Plumbago, 12 oz.....	30
7109. Crucibles, Berlin porcelain with cover, $\frac{1}{2}$ oz.....	18
7110. Crucibles, Berlin porcelain with cover, $1\frac{1}{2}$ oz.....	40
7111. Crucibles, Berlin porcelain with cover, 2 oz.....	50
7112. Crucibles, Berlin porcelain with cover, 4 oz.....	60
7113. Crucibles (Beaufay's), clay free from iron, 2 oz.....	10
7114. Crucibles (Beaufay's), clay free from iron, 4 oz.....	15
7115. Crucibles (Beaufay's), clay free from iron, 6 oz.....	20
7116. Crucibles (Beaufay's), clay free from iron, 12 oz.....	25
7117. <b>Crucible Tongs</b> , large.....	1 75
7118. Crucible Tongs, small, steel.....	1 50
7130. <b>Deflagrating Spoons</b> , 14 inches long.....	25
7131. Deflagrating Spoons, 20 inches long.....	40
7132. <b>Drying Oven</b> , with Kemp's regulator.....	3 50
7133. <b>Dropping Tubes</b> , each.....	10
7140. <b>Eolipile of Glass</b> , for ether.....	25
7141. <b>Evaporating Dishes</b> , of royal Berlin porcelain, holding 2 oz.....	30
7142. Evaporating Dishes, same as No. 7141, but holding 3 oz.....	35
7143. Evaporating Dishes, same as No. 7141, but holding 4 oz.....	45
7144. Evaporating Dishes, same as No. 7141, but holding 6 oz.....	65
7145. Evaporating Dishes, same as No. 7141, but holding 8 oz.....	70
7146. Evaporating Dishes, same as No. 7141, but holding a pint.....	1 00
7147. Evaporating Dishes, same as No. 7141, but holding 2 quarts.....	2 00
7150. <b>Filtering Stands</b> , of hard wood.....	1 00
7151. <b>Filtering Paper</b> , German, per quire.....	40
7152. Filtering Paper, Swedish, per quire.....	1 25
7153. <b>Filtering Apparatus</b> , Bunsen's.....	11 00
7154. <b>Flask</b> . Glass, without lead, round bottom, four ounce.....	20
7155. Flask. Same as 6954, but half pint.....	25
7156. Flask. Same as 6954, but pint.....	35
7157. Flask. Same as 6954, but quart.....	40
7158. <b>Flask</b> . Similar to 7154, but with flat bottom, half pint.....	25
7160. Flask. Same as No. 7158, pint.....	35
7161. Flask. Same as No. 7158, quart.....	40

	PRICE
7162. Flask. Same as No. 7158, half gallon . . . . .	\$0 75
7163. Flask. Same as No. 7158, one gallon . . . . .	1 00
7164. Flask. Same as No. 7158, two gallons . . . . .	1 75
7165. Forceps. Strong steel for bending wire, round jaws . . . . .	75
7166. Forceps. Strong steel for cutting wire . . . . .	75
7167. Forceps. Steel, with platinum points, double form . . . . .	2 00
7168. Funnel. Of glass, ordinary style, four ounce . . . . .	12
7169. Funnel. Of glass, ordinary style, eight ounce . . . . .	15
7170. Funnel. Of glass, ordinary style, pint . . . . .	18
7171. Funnel. Of glass, ordinary style, quart . . . . .	25
7172. Funnel. Of glass, ordinary style, half gallon . . . . .	30
7173. Funnel. Of glass, ordinary style, one gallon . . . . .	40
7174. Funnel. Porcelain ribbed, pint . . . . .	1 25
7175. Funnel. Porcelain ribbed, quart . . . . .	1 75
7176. Funnel. Best Bohemian glass, angle of 60°, stem with parallel sides, for Bunsen's filtering apparatus, two inches diameter . . . . .	15
7177. Funnel. Same. Three inches diameter . . . . .	20
7178. Funnel. Same. Four inches diameter . . . . .	25
7179. Funnel. Same. Five inches diameter . . . . .	30
7180. Funnel. Separating, conical, of best Bohemian glass, with stop-cock ground into the stem, four inches . . . . .	2 50
7181. Funnel. Same. Six inches . . . . .	3 25
7182. Funnel. Same. Eight inches . . . . .	4 50
7183. Funnel Tubes. Plain, glass, conical . . . . .	20
7184. Funnel Tubes. Plain, glass, globular top . . . . .	20
7185. Funnel Tubes. Welter's safety, with one bulb . . . . .	30
7186. Funnel Tubes. Welter's safety, with two bulbs . . . . .	40
7187. Funnel Tubes. Welter's safety, with three bulbs . . . . .	50
7200. Graduate Glasses. English form, with foot and lip, two ounce . . . . .	30
7201. Graduate Glasses. English form, with foot and lip, four ounce . . . . .	40
7202. Graduate Glasses. English form, with foot and lip, eight ounce . . . . .	60
7203. Graduate Glasses. English form, with foot and lip, sixteen ounce . . . . .	75
7204. Graduated Cylinders. On foot, for mixing; 100 cubic centimeters graduated to $\frac{1}{10}$ c. c. . . . .	1 25
7205. Same. 500 cubic centimeters graduated to 5 c. c. . . . .	2 00
7206. Same. 1000 cubic centimeters graduated to 10 c. c. . . . .	4 25
7206½. Glass Tubing. Per pound . . . . .	75
7207. Mohr's Burettes. With spring compressor, 30 c. c. graduated to $\frac{1}{10}$ c. c. . . . .	1 25
7208. Same. 50 c. c. graduated to $\frac{1}{2}$ c. c. . . . .	1 50
7209. Rotating Stand, for ten burettes . . . . .	4 00
7210. Spring Compressor. Of wood . . . . .	15
7211. Spring Compressor. Of brass . . . . .	20
7212. Pipettes. Plain . . . . .	15
7213. Pipettes. Bulbed . . . . .	15
7220. Hydrometers, Beaumé's, for spirits. Each . . . . .	75
7221. Hydrometers, for ether. Each . . . . .	75
7222. Hydrometers, for sugar. Each . . . . .	75
7223. Hydrometers, for milk. Each . . . . .	75
7224. Hydrometers, for beer. Each . . . . .	75
7225. Hydrometers, for bark liquor. Each . . . . .	75
7226. Hydrometers, for wine must. Each . . . . .	75
7227. Hydrometers, for coal-oil. Each . . . . .	75
7228. Hydrometers, for alkali. Each . . . . .	75
7229. Hydrometers, for acid. Each . . . . .	75



7028-7030.

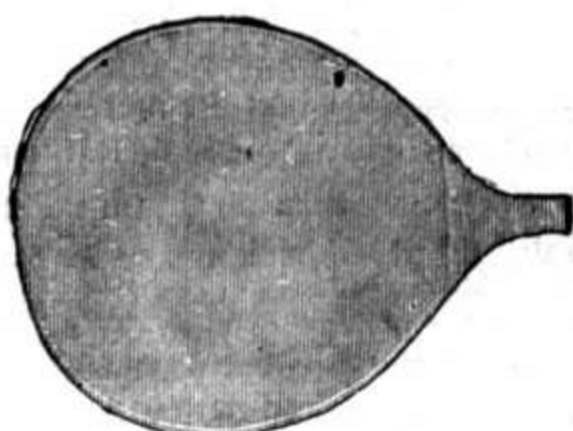

7018-7024.



7220-7229.



7090.



7186.

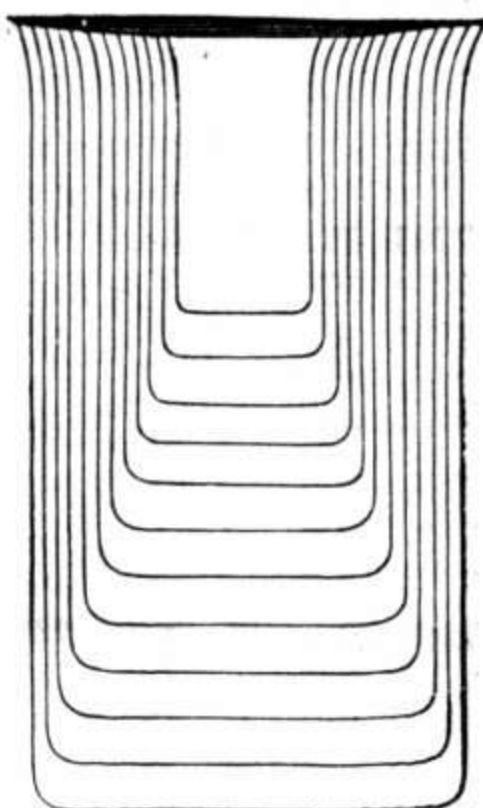

7207-7208.

7078.

7082.



7141-7147.



7270-7280.



7265-7269.



7392-7394.

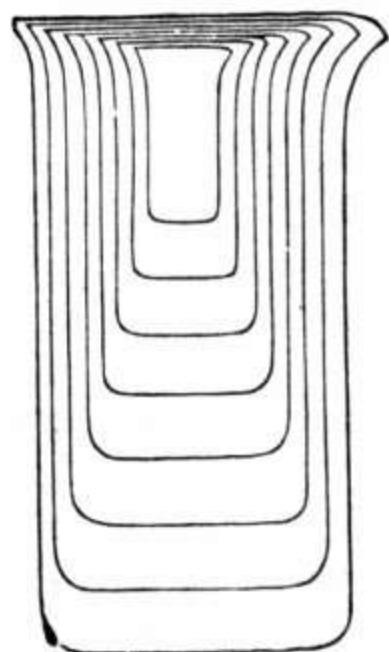

7079.



7109-7112.



7158-7164.

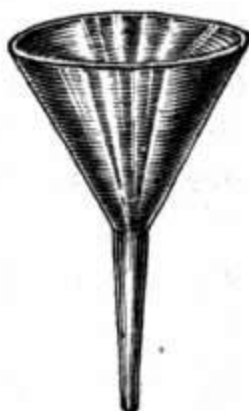

7168-7173.



7176.

	PRICE
7230. <b>Hydrometers</b> , for acid, with thermometer. Each.....	\$2 00
7231. Hydrometers, for salt. Each.....	75
7232. Hydrometers, pair of Beaumé's, with sp. gravity also marked on the scale, from 1,000 to 800 sp. grav., for heavy, and from 1,000 to 1,933 sp. grav., for light liquids; in a neat case, with thermometer and jar.....	8 00
7233. <b>Hydrometers, Twaddle's</b> , for dyers and calico-printing, Nos. 1, 2, 3, 4, each.....	75
7234. <b>Hydrometer. U. S. Revenue</b> , for alcohol, with thermometer.....	2 00
7235. Hydrometer. Same as No. 7034, in neat mahogany case with key, with jar, for floating.....	6 00
7236. <b>Hydrometer Jars</b> , plain.....	60
7237. Hydrometer jars, with lip.....	75
7238. <b>Urinometer</b> , with sp. gravity scale, plain.....	75
7239. Urinometer, with sp. gravity scale, in case, with jar.....	1 00
7240. Urinometer, in morocco case, with graduated glass.....	3 50
7241. Urinometer. Same as No. 7240, but with the addition of thermometer.....	6 00
7242. Urinometer. Fine finish, with thermometer, and bottles for reagents, in neat morocco case, very complete.....	8 00
7243. <b>Picnometer</b> .....	50
7244. Picnometer, with thermometer.....	6 00
7260. <b>Mercury Trough</b> . Of porcelain, holding 5 lbs.....	1 00
7261. Mercury Trough. Of porcelain, holding 16 lbs.....	2 00
7262. <b>Mortars. Glass</b> , with pestle, 3 inches.....	40
7263. Mortars. Glass, with pestle, 5 inches.....	70
7264. Mortars. Glass, with pestle, 6 inches.....	1 00
7265. Mortars. <b>Iron, with pestle</b> , smooth inside, 4 inches across top.....	60
7266. Mortars. Iron, with pestle, 5 inches across top.....	85
7267. Mortars. Iron, with pestle, 6 inches across top.....	1 25
7268. Mortars. Iron, with pestle, 7 inches across top.....	1 75
7269. Mortars. Iron, with pestle, 9 inches across top.....	2 75
7270. Mortars. With pestle, <b>best wedgewood</b> , 3 inches across top.....	40
7271. Mortars. With pestle, best wedgewood, 4 inches across top.....	55
7272. Mortars. With pestle, best wedgewood, 4½ inches across top.....	65
7273. Mortars. With pestle, best wedgewood, 5 inches across top.....	75
7274. Mortars. With pestle, best wedgewood, 5½ inches across top.....	80
7275. Mortars. With pestle, best wedgewood, 6 inches across top.....	1 05
7276. Mortars. With pestle, best wedgewood, 6½ inches across top.....	1 20
7277. Mortars. With pestle, best wedgewood, 7 inches across top.....	1 55
7278. Mortars. With pestle, best wedgewood, 8 inches across top.....	2 20
7279. Mortars. With pestle, best wedgewood, 10 inches across top.....	3 50
7280. Mortars. With pestle, best wedgewood, 12 inches across top.....	5 00
7281. Mortars. With pestle, <b>porcelain, unglazed within</b> , 4 inches diameter.....	70
7282. Mortars. With pestle, porcelain, unglazed within, 4½ inches diameter.....	1 00
7283. Mortars. With pestle, porcelain, unglazed within, 5½ inches diameter.....	1 25
7284. Mortars. With pestle, porcelain, unglazed within, 6 inches diameter.....	1 50
7285. Mortars. With pestle, porcelain, unglazed within, 6½ inches diameter.....	2 00
7286. Mortars. With pestle, porcelain, unglazed within, 7 inches diameter.....	2 25
7287. Mortars. <b>Agate</b> , with pestles of same material, 1½ inch diameter..	2 25
7288. Mortars. Agate, with pestles of same material, 2 inches diameter...	2 75
7289. Mortars. Agate, with pestles of same material, 2½ inches diameter..	4 00
7290. Mortars. Agate, with pestles of same material, 3 inches diameter...	7 00
7300. <b>Ozonometer</b> . Small model.....	5 00
7301. <b>Platinum Wire</b> . No. 36, per yard.....	50
7302. Platinum Wire. No. 30, per yard.....	40

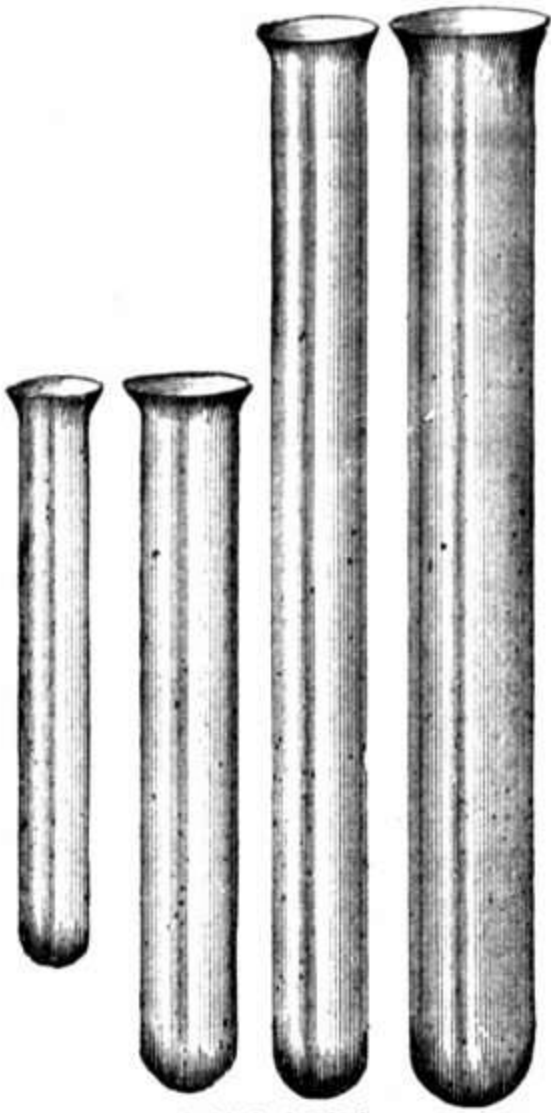

7370-7374.

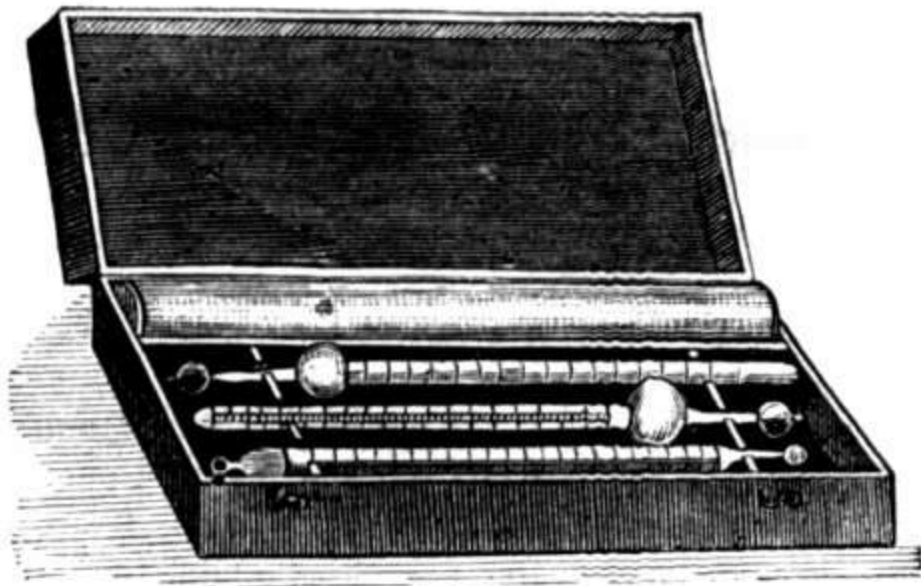

7232.

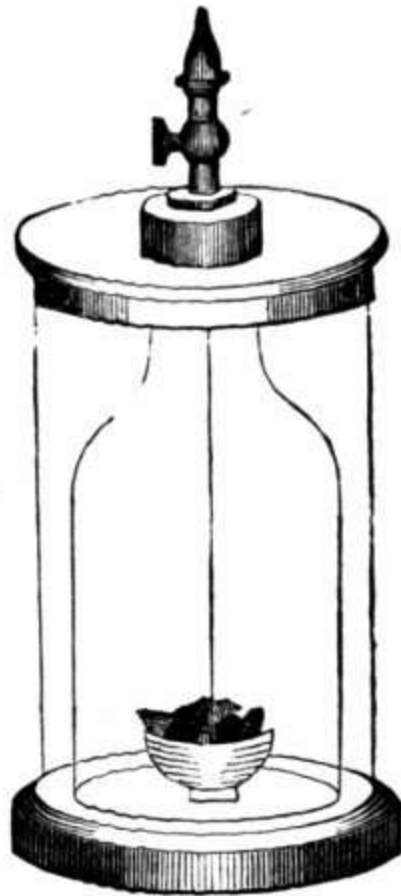
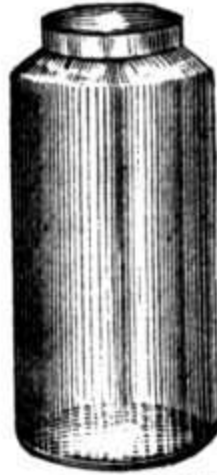

7006.



7080-7081.

7354-7394.

350-7353.

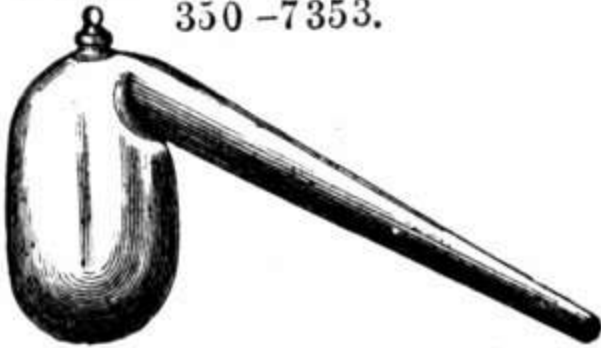

7320-7327.



7262-7264.

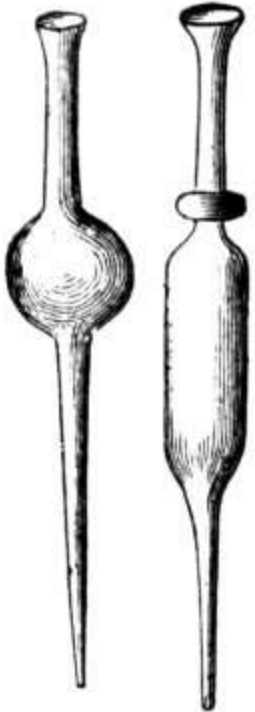

7212. 7213.

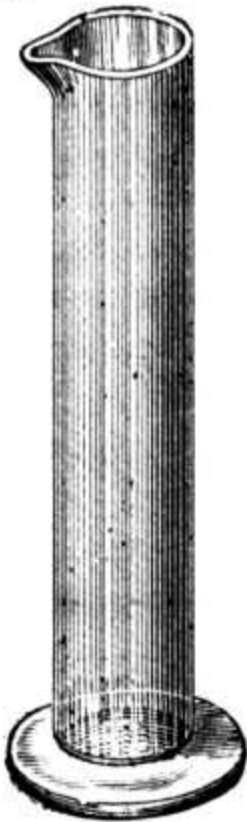

7237.



7204-7206.

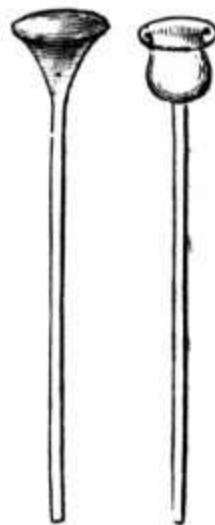

7183. 7184.

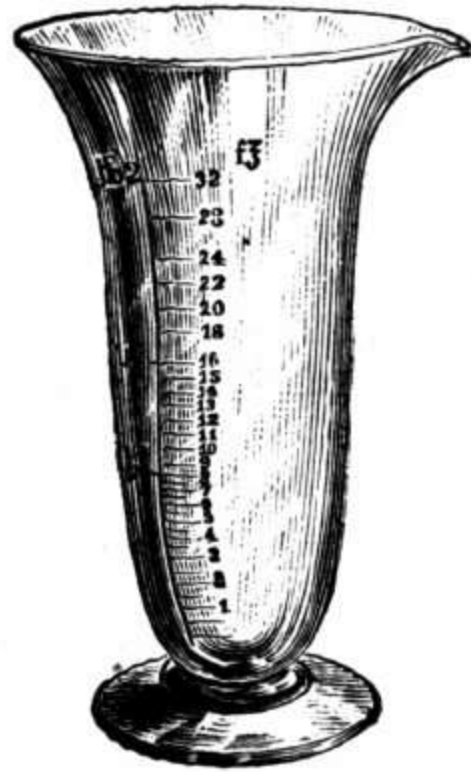

7200-7203.

	PRICE
7303. Platinum Wire. No. 24, per gramme .....	
7304. Platinum Wire. No. 18, " .....	
7305. Platinum Wire. No. 12, " .....	
7306. <b>Platinum Foil.</b> " .....	
7307. <b>Platinum Spoons.</b> " .....	
7308. <b>Platinum Sponge,</b> best, each .....	25
7309. <b>Pneumatic Trough.</b> Deep form, of neatly japanned tin. with sliding shelf for jar .....	4 00
7310. <b>Pneumatic Trough.</b> Same as No. 7309, but made of strong copper, neatly japanned .....	10 00
Receivers. See Chapter III., Section V.	
7311. <b>Retorts.</b> Glass, free from lead, plain, 1 ounce .....	10
7312. <b>Retorts.</b> Glass, free from lead, plain, 2 ounce .....	15
7313. <b>Retorts.</b> Glass, free from lead, plain, 4 ounce .....	25
7314. <b>Retorts.</b> Glass, free from lead, plain, 8 ounce .....	30
7315. <b>Retorts.</b> Glass, free from lead, plain, 16 ounce .....	40
7316. <b>Retorts.</b> Glass, free from lead, plain, 32 ounce .....	50
7317. <b>Retorts.</b> Glass, free from lead, plain, 64 ounce .....	80
7318. <b>Retorts.</b> Glass, free from lead, plain, 2 gallon .....	1 80
7319. <b>Retorts.</b> Glass, free from lead, plain, 4 gallon .....	3 00
7320. <b>Retorts.</b> Glass, free from lead, tubulated with ground stopper, 2 oz. .	30
7321. <b>Retorts.</b> Glass, free from lead, tubulated with ground stopper, 4 oz. .	35
7322. <b>Retorts.</b> Glass, free from lead, tubulated with ground stopper, 8 oz. .	40
7323. <b>Retorts.</b> Glass, free from lead, tubulated with ground stopper, pint. .	50
7324. <b>Retorts.</b> Glass, free from lead, tubulated with ground stopper, quart. .	75
7325. <b>Retorts.</b> Glass, free from lead, tubulated with ground stopper, $\frac{1}{2}$ gal. .	1 00
7326. <b>Retorts.</b> Glass, free from lead, tubulated with ground stopper, 1 gal. .	1 50
7327. <b>Retorts.</b> Glass, free from lead, tubulated, with ground stopper, 4 gall. .	4 50
7328. <b>Retort Stand.</b> Of iron, with three rings, on iron base, improved form .	1 00
7399. <b>Retort Stand.</b> Of wood, with cork shields .....	1 25
7330. <b>Retort Stand.</b> Universal, iron base, wooden arms, very firm and strong .....	5 00
7350. <b>Spatula.</b> Of steel, with handle, blade 3 inches long .....	25
7351. <b>Spatula.</b> Of steel, with handle, blade 5 inches long .....	35
7352. <b>Spatula.</b> Of steel, with handle, blade 6 inches long .....	40
7353. <b>Spatula.</b> Of steel, with handle, blade 8 inches long .....	60
Spirit Lamps. See Chapter VI., Section I.	
Syphons. See Chapter III., Section IV.	
7354. <b>Specie Jars.</b> For collecting gases, very strong, pint .....	25
7355. <b>Specie Jars.</b> For collecting gases, very strong, quart .....	35
7356. <b>Specie Jars.</b> For collecting gases, very strong, $\frac{1}{2}$ gallon .....	50
7357. <b>Specie Jars.</b> For collecting gases, very strong, gallon .....	75
7370. <b>Test Tubes.</b> German glass, free from lead, 3 inches long, per dozen. .	25
7371. <b>Test Tubes.</b> German glass, free from lead, 4 inches long, per dozen. .	30
7372. <b>Test Tubes.</b> German glass, free from lead, 5 inches long, per dozen. .	40
7373. <b>Test Tubes.</b> German glass, free from lead, 6 inches long, per dozen. .	50
7374. <b>Test Tubes.</b> German glass, free from lead, 7 inches long, per dozen. .	60
7375. <b>Test Tube Racks.</b> White wood, per dozen tubes .....	75
7376. <b>Test Tube Racks.</b> Of mahogany, with pins for draining .....	75
7390. <b>Woulfe's Bottles.</b> With two necks, $\frac{1}{2}$ pint .....	40
7391. <b>Woulfe's Bottles.</b> With two necks, pint .....	50
6392. <b>Woulfe's Bottles.</b> With three necks, $\frac{1}{2}$ pint .....	60
7393. <b>Woulfe's Bottles.</b> With three necks, pint .....	75
7394. <b>Woulfe's Bottles.</b> With three necks, quart .....	1 00
7395. <b>Watch Glasses.</b> Assorted, per dozen .....	40



**MISCELLANEOUS GLASS-WARE, Etc.**

**New Re-agent Bottles, Lettered.**

"These bottles have the 'chemical names and equivalents' distinctly blown in the glass, thus avoiding the danger of confusion and the unsightly appearance of paper labelled bottles, also the heavy expense of bottles with engraved labels. We have moulds for the following  $\frac{1}{4}$  pint,  $\frac{1}{2}$  litre, humid re-agents:"



7400.

1. HYDRIC SULPHIDE, (AMBER.)
2. " CHLORIDE.
3. " ACETATE.
4. " SULPHATE.
5. " NITRATE.
6. POTASSIC FERROCYANIDE.
7. " SULPHOCYANIDE.
8. " CARBONATE.
9. " SULPHATE.
10. " IODIDE.
11. " FERRICYANIDE.
12. " HYDRATE.
13. " ACID CHROMATE.
14. DI SODIC HYDRIC PHOSPHATE.
15. AMMONIC HYDRATE.
16. " SULPHIDE, (AMBER.)
17. " CHLORIDE.
18. " CARBONATE.
19. " OXALATE.
20. BARIIC CHLORIDE.
21. CALCIIC "
22. " SULPHATE.
23. " HYDRATE.
24. MAGNESIC SULPHATE.
25. MERCURIC CHLORIDE.
26. ARGENTIC NITRATE, (AMBER.)
27. PLUMBIC ACETATE.
28. FERROUS SULPHATE.
29. FERRIC CHLORIDE.
30. ALCOHOL.
31. AMMONIC SULPHOCYANIDE.
32. BARIIC HYDRATE.
33. " CARBONATE.
34. AMMONIC SULPHOCYANATE.
35. ETHER.
36. CUPRIC SULPHATE.
37. PLATINIC CHLORIDE.
38. 39, 40, BLANK.

"These bottles are made of glass containing *no lead, zinc, or other metallic flux*, and in the points of true shape, thin dropping lip, and perfect stoppering, we believe them to be superior to the imported bottles in general use. Prominent chemists and the leading Universities express entire approval of the lettered Re-agent bottle."

	PRICE
7400. Set of forty 4-oz. bottles, with ground letters .....	\$5 83
7402. One set of twenty-seven $\frac{1}{2}$ -pint bottles, $\frac{1}{4}$ litre, 3 blanks.....	5 00
7403. One set of twelve pint Re-agent bottles, $\frac{1}{2}$ litre.....	3 25
7404. Pint stoppered acid bottles, lettered, Nitric Acid, Sulphuric Acid, Muriatic Acid, per doz.....	3 50
7405. Acid bottles, same as No. 7404, quarts, per doz .....	4 75
<b>Bottles, of white glass, narrow mouth, with ground stoppers.</b>	
7407. 1 gallon. Per dozen.....	6 50
7408. $\frac{1}{2}$ " " .....	4 50
7409. 32 ounce. " .....	2 50
7410. 16 " " .....	2 00
7411. 8 " " .....	1 35
7412. 4 " " .....	1 00
7413. 2 " " .....	90

	PRICE
7414. 1 ounce. Per dozen.....	80
7415. ½ " " .....	75
<b>Bottles, wide mouth, white glass, stoppered.</b>	
7417. 1 gallon. Per dozen.....	\$7 00
7418. ½ " " .....	5 00
7419. Quart " .....	3 00
7420. Pint " .....	2 25
7421. ½ " " .....	1 50
7422. 4 ounce. " .....	1 15
7423. 2 " " .....	1 90
7424. 1 " " .....	80
7425. ½ " " .....	75
<b>Bottles, wide and narrow mouths, of white glass, for corks.</b>	
7427. ½ ounce. Per dozen.....	20
7428. 1 " " .....	25
7429. 2 " " .....	30
7430. 4 " " .....	35
7431. 6 " " .....	50
7432. 8 " " .....	60
7433. 16 " " .....	90
7434. 32 " " .....	1 25
<b>Bottles, heavy glass, stoppered, with ground glass cap and enameled labels for Sulphuric, Nitric and Muriatic Acids.</b>	
7436. ½ pint.....	1 00
7437. Pint.....	1 50
<b>Bottles similar to No. 7457, but without enameled labels.</b>	
7439. ½ pint .....	60
7440. Pint.....	80
7441. Quart.....	1 00

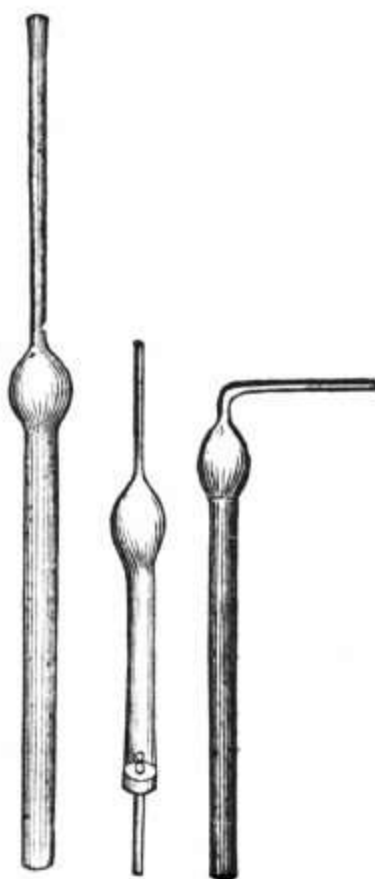
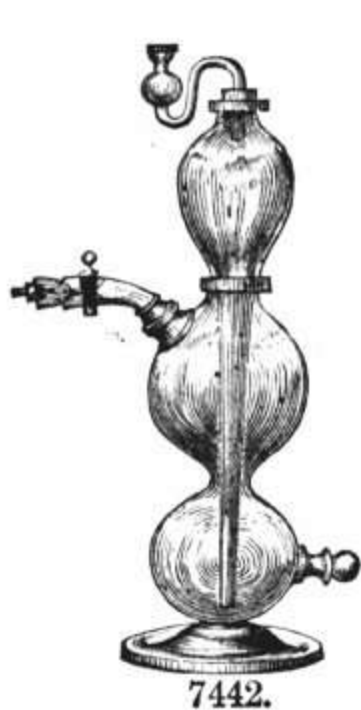

7442. <b>Kipp's Apparatus, for sulphurated hydrogen.....</b>	<b>5 00</b>
--	-------------

	PRICE
7443. Chloride Calcium Tubes. Three forms, each.....	25
Receivers for Retorts, globular stoppered.	
7445. $\frac{1}{2}$ pint.....	40
7446. " .....	50
7447. Quart.....	80
7448. $\frac{1}{2}$ gallon.....	\$1 00



7449.



7450.



7451.



7452.

7449. Liebig's Potash Bulb .....	50
7450. Mitcherlich Potash Bulb.....	40
7451. Stop-cock of Glass, accurately ground—bent.....	1 25
7452. Stop-cock of glass—straight.....	1 25
7453. Glass Rods for Stirring, ends melted, 4 inches long. Per doz.....	25
7454. Glass Rods for Stirring, ends melted, 6 inches long. Per doz.....	50
7455. Glass Rods for Stirring, ends melted, 10 inches long. Per doz.....	75
7456. Bottles with Tubulature. Quart.....	60
7457. Bottles with Tubulature. Half gallon.....	80



7460-7462.



7463-7464.

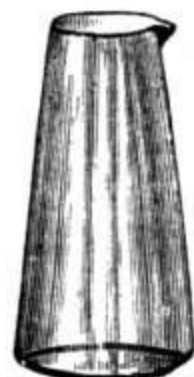

7467-7470.



7471-7474.

7460. Bottles with Tubulature, stoppered. Pint.....	75
7462. Bottles with Tubulature, stoppered. Quart.....	1 00
7463. Bottles with Tubulature, accurately stoppered, with glass stop-cock ground into the tubulature. Pint.....	3 00
7464. Bottles with Tubulature, accurately stoppered, with glass stop-cock ground into the tubulature. Quart.....	4 00
7467. Precipitating Jars, $\frac{1}{4}$ pint.....	20
7468. Precipitating Jars, $\frac{1}{2}$ pint.....	30
7469. Precipitating Jars, pint.....	40
7470. Precipitating Jars, quart.....	60
7471. Percolators, pint. ....	50
7472. Percolators, quart.....	65
7473. Percolators, $\frac{1}{2}$ gallon.....	1 00
7474. Percolators, gallon.....	1 25
7475. Thermometers, Chemical. Graduated on tube $212^{\circ}$ to $360^{\circ}$ fahrenheit.....	1 75 to 2 25
7476. Thermometers, Chemical, with enameled scale, $120^{\circ}$ fahrenheit to $360^{\circ}$ fahrenheit.....	1 00 to 2 0

		PRICE
7477.	Oxygen Globes, 12 inches in diameter, with short neck and ground rim; for the deflagration of phosphorus in oxygen. Mounted on stand .....	\$3 00
7478.	Globes without stand and spoon.....	1 50
<p style="text-align: center;"><b>Evaporating Dishes, Porcelain.</b> These dishes are well adapted for experimental purposes, and are not attached except by solutions of the caustic alkalis.</p>		
7480.	2 ounce.....25 cents.	1 35
7481.	4 " .....30 "	2 00
7482.	8 " .....35 "	5 00
7483.	16 " .....50 "	7 00
7484.	32 " .....90	

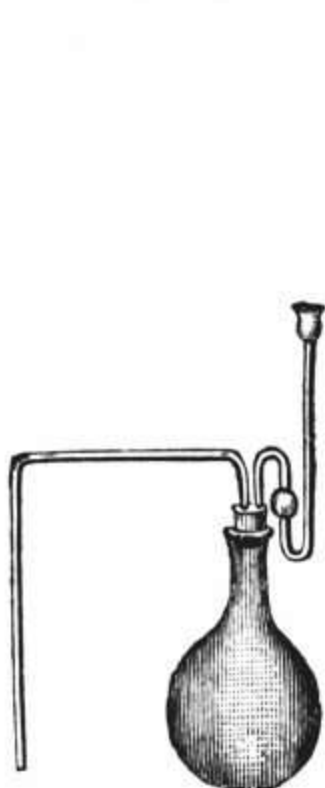

7486.



7487.



7488.

7485.	Wash Bottle.....	50
7486.	Gas Bottle, for Chlorine, etc., with Wetler's safety tube.....	1 25
7487.	Bink's Burette, 50 c c, graduated to $\frac{1}{5}$ .....	1 75
7488.	Steam Atomizer, of improved construction.....	5 00
7489.	Water baths, Porcelain, 2 ounce.....	1 75
7490.	Water Baths, Porcelain, 4 ounce.. ..	2 00



7485.

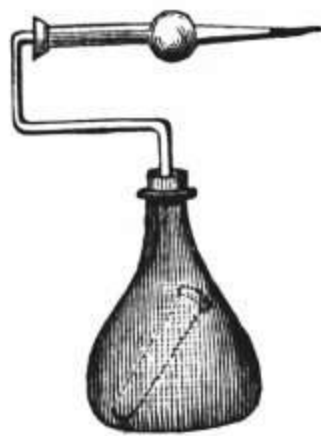

7501.

7492.	Water Baths, copper, with three concentric rings, 6 inches in diam....	2 00
7493.	Bladders .....	06

7494.	<b>Blow-pipe Case</b> , for analysis, containing set of re-agents. Plattner's blow-pipe, (in sections), with platinum tip, blow-pipe, lamp, tongs, forceps, Berzelius hammer, platinum spoon, wire and foil, agate mortar, steel anvil, etc., etc., in case.....	\$22 00
7500.	Blow-pipe Re-agent Case, filled with re-agents.....	1 75
7501.	<b>Carbonic Acid Apparatus</b> .....	75
7502.	<b>Apparatus for Generating Chlorine</b> , etc. Quart flask, safety tube and bent tube.....	75
7506.	<b>Arsenic Reduction Tubes</b> . Per doz.....	50
7507.	<b>Graduates, Metric.</b> 25 c. c.....	40
	" " 30 ".....	50
	" " 50 ".....	65
	" " 100 ".....	80
	" " 150 ".....	1 00
	" " 200 ".....	1 25
	" " 250 ".....	1 50
7508.	<b>Brushes for Cleaning Test Tubes</b> .....	06
7509.	<b>Wash Bottle</b> , for washing precipitates with a constant supply of water.....	60
7510.	<b>Lead Dish</b> , for hydrofluoric acid.....	30
7513.	<b>Clay Furnace</b> .....	1 00
7514.	<b>Furnace Cupel</b> , fine clay, iron bound, with muffle.....	15 00
7516.	<b>Furnace, Liebig's</b> , for organic analysis, sheet iron, 24 inches long..	3 50
7518.	<b>Hibbs' Assay Furnace</b> .....	40 00
7519.	Muffles for same.....	1 25
7520.	<b>Improved Cork Presser</b> .....	1 25

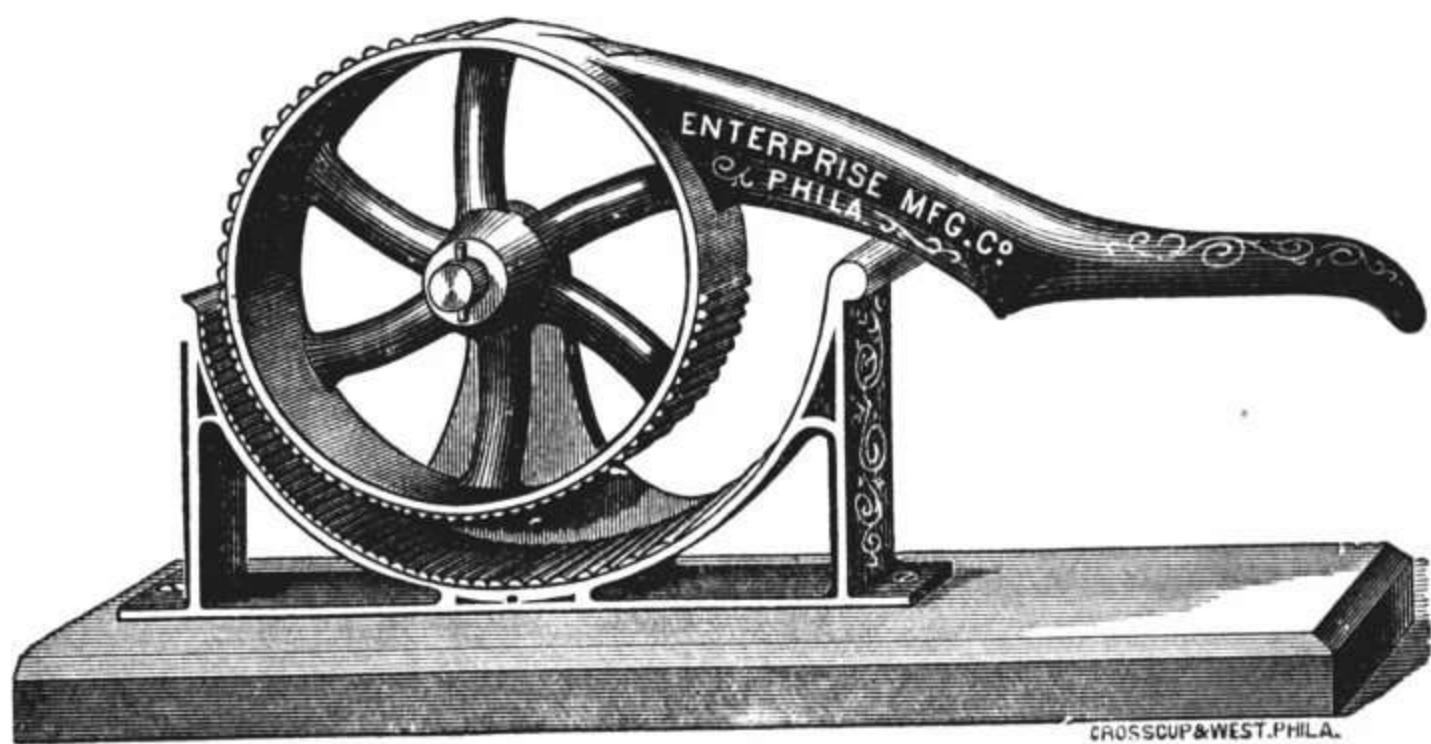

7520.

7521.	<b>Tripods</b> , iron, with movable feet.....	50
	<b>Filters.</b> Cut in circular form to suit the different size funnels, heavy French filtering paper in packages of 100.	
7523.	Filters for 2 ounce funnel, per package.....	30
7524.	" " 4 " " " ".....	40
7525.	" " 8 " " " ".....	50
7526.	" " pint " " " ".....	70
7527.	" " quart " " " ".....	80
7528.	" " gal. " " " ".....	1 25

	PRICE
7529. <b>Carre's Ice Freezing Apparatus</b> .....	\$75 00
7530. <b>Blow-pipe Forceps</b> , German Silver, with platinum points.....	2 00
7531. <b>Anvils</b> , polished steel.....	1 25
7532. <b>Bellows</b> , foot of latest construction.....	5 00
7533. <b>Alkalimeter</b> , Bink's, 50 c. c. grad. to $\frac{1}{2}$ .....	1 75
7534. <b>Hofman's Apparatus</b> , for decomposition and recomposition of water by electricity.....	9 00
7535. <b>Bunsen's Filter Pump</b> .....	11 00
7536. <b>Cork-screws</b> , best.....	30
7537. <b>Bunsen Burner</b> , with Prof. Morton's arrangement to prevent the receding of the flame.....	75
7538. <b>Rotating Stand</b> , holding 12 burettes.....	4 00
7539. Stand for two burettes.....	1 50
<b>Set Chemical Labels</b> , with old and new nomenclature. Per set...	25
7540. <b>Sand Baths</b> . Hemispherical, of sheet iron, 3 inches in diameter...	10
7541. Sand Baths. Hemispherical, of sheet iron, 5 inches in diameter.....	25
7542. <b>Crooke's Radiometer</b> , of best construction. (Imported.).....	7 50

Fletcher's Blowpipe Apparatus all sizes.

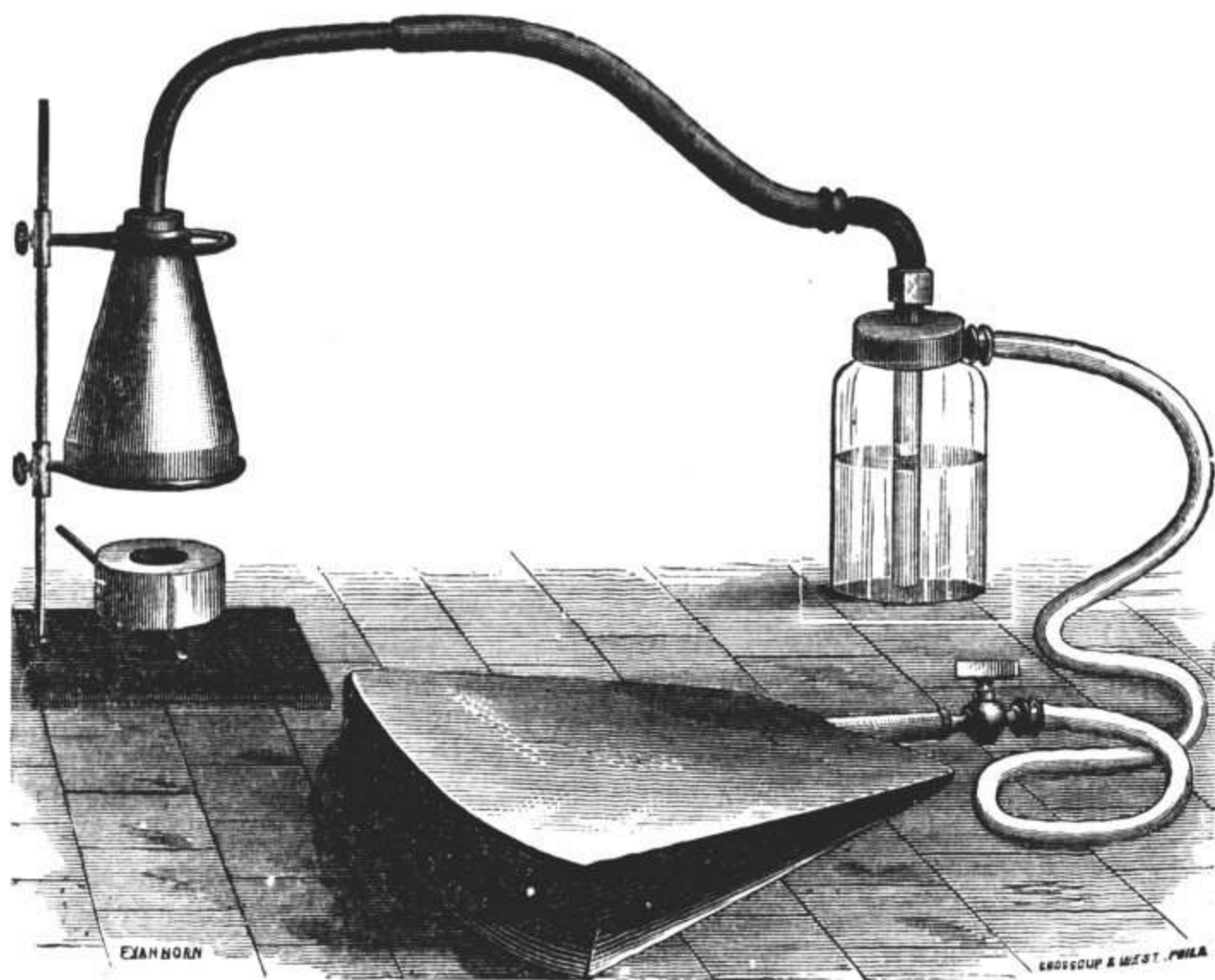

7000.

**QUEEN'S NEW AND IMPROVED SET OF PHILOSOPHICAL APPARATUS. No. 1. Price, \$100.00.**

We would call attention to the complete character of this set, containing, as it does, one of Ruhmkorff's celebrated Induction Coils, one of Geissler's beautiful Tubes, Meter and Yard, Queen's new Toepler-Holtz Electrical Machine, etc.

It is sufficient for the performance of the leading experiments in ordinary text-books, and we would recommend it to such schools as have not the means to purchase a more complete collection of apparatus. The numbers attached to some instruments refer to our large and profusely illustrated catalogue of Physical Instruments, which can be obtained upon application. Those articles without numbers have been specially added to meet the wants of this set.

We are the largest manufacturers and importers of School Apparatus in the United States; our facilities enable us to supply *better apparatus*, and more of it for the money, than can be obtained elsewhere.

<b>MECHANICS.</b>		<b>HEAT.</b>	
No.	PRICE.	No.	PRICE.
—	Meter and Yard.....	5034.	Pulse Glass, Franklin's.....
	\$0 50	4900.	Air Thermometer.....
4034.	Set Capillary Tubes.....		25
	1 25	—	Mercurial Thermometer.....
4075.	Centrifugal Hoops.....		50
	3 50	4831.	Spirit Lamp.....
4061.	Set 5 Collision Balls.....		50
	4 50	4909.	Compound Bar.....
4060.	Inertia Apparatus.....		1 00
	1 00	—	1/4 lb. Glass tubing, assorted.....
4029.	1/2 doz. Prince Rupert Drops.....		20
	20	7156.	Glass Flask.....
	\$10 95		40
			\$3 60
<b>PNEUMATICS.</b>		<b>STATIC ELECTRICITY.</b>	
4260.	Air Pump, most improved.....	—	Queen's No. 1 Toepler-Holtz Elec- trical Machine, gives brilliant dis- charges three to five inches long, works in all weathers.....
	\$20 00		\$25 00
—	Receiver for Air Pump.....	5374.	Spiral Tube, very beautiful.....
	5 00		2 50
4320.	Fountain in Vacuo.....	5311.	Leyden Jar, quart.....
	5 00		1 50
4310.	Hand and Bladder Glass.....	5275.	Set Electric Bells.....
	1 00		1 75
4315.	Magdeburg Hemispheres, 4 inches diameter.....	5345.	Electrical Discharger, with Rubber Handle.....
	5 50		2 25
—	Barometer Tube, Glass Cup and Mercury Pipette for filling above	5294.	Pair of Image Plates.....
	2 00		1 50
	\$33 50	5297.	Pair of Images.....
			75
			\$35 25
<b>OPTICS.</b>		<b>HYDROSTATICS.</b>	
3055.	Microscope, No. 1.....	4163.	Equilibrium Tubes, Set of Six Forms, Base of Tin, neatly Japanned.....
	\$3 50		\$3 50
—	Concave and Convex Mirrors.....	—	Hydrometer for taking the Specific Gravity of Liquids.....
	3 00		50
1766.	Prism, Solid Flint Glass.....	—	Hydrometer Jar.....
	50		50
1790.	Set Six Demonstration Lenses, two inches in diameter, in a neat wood case.....	4170.	Bottle Imp and Bottle.....
	2 50		75
	\$9 50	4204.	Siphon, Glass.....
			40
<b>MAGNETISM AND GALVANISM.</b>		4361.	Water Hammer.....
—	Geissler's Tube.....		1 00
	\$0 75	4238.	Lifting Pump, all of Glass, with Conical Valves.....
5479.	Grenet Battery.....		2 00
	2 00	4239.	Forcing Pump, all of Glass, with Conical Valves.....
5726.	Induction Coil (Ruhmkorff).....		2 00
	6 00		\$10 65
5176.	Horseshoe Magnet.....		
	60		
5637.	Electro-magnet.....		
	1 50		
5146.	Magnetic Needle.....		
	2 00		
	\$12 85		

Mechanics.....	\$10 95
Pneumatics.....	33 50
Optics.....	9 50
Magnetism and Galvanism.....	12 85
Heat.....	3 60
Static Electricity.....	35 25
Hydrostatics.....	10 65
	\$116 30
Boxing and Packing.....	2 50
Total.....	\$118 80
Net price per set, complete.....	\$100 00

## QUEEN'S NEW SET OF PHILOSOPHICAL APPARATUS. No. 2.

### Price, \$150.00.

Expressly prepared for use in connection with Steele's "Fourteen Weeks in Physics," new edition. Also suitable for use with Avery's Philosophy, Baker's Philosophy, or any other good work on Physics.

PROPERTIES OF MATTER.		PRICE.	ACOUSTICS.		PRICE.
No.			No.		
—	Meter and Yard .....	\$0 50	—	Diapason, with Style for Drawing	
4028 $\frac{1}{2}$	Balance.....	1 60	—	Vibrations on Smoked Glass.....	\$6 50
6976	Weights, iron, 1 lb. to $\frac{1}{4}$ oz.....	50	—	Bow.....	2 50
4060	Inertia Apparatus.....	1 00	—	Resonant Jar.....	2 00
4061	Collision Balls.....	4 50	4675	Sonometer.....	10 00
—	Collision Plate, of Marble, with Ivory Ball.....	3 50	—	Glass Plate for Chladni Figures.....	2 00
4088	Gyroscope.....	2 50	4720	Holder for Chladni Figures.....	5 00
4030	1 Pair Cohesion Plates, of Glass.....	75	4624	Organ Tube.....	2 50
4029	$\frac{1}{2}$ dozen Prince Rupert Drops.....	20			\$30 50
4034	1 Set Capillary Tubes.....	1 25	OPTICS.		
—	Apparatus for Diffusion of Liquids.....	1 00	3056	The School Microscope.....	\$6 00
—	Apparatus for Osmose of Liquids....	4 00	1766	Prism, Solid Glass.....	50
—	Apparatus for Diffusion of Gases....	1 00	1790	Set 6 Demonstration Lenses.....	2 50
—	Apparatus for Osmose of Gases.....	3 50	—	Concave and Convex Mirrors.....	3 00
—	Centre of Gravity.....	1 25			\$12 00
4075	Central Forces.....	3 50	HEAT.		
		\$30 55	—	Crooke's Radiometer.....	\$4 50
MECHANICS.			5034	Franklin's Pulse Glass.....	75
—	Lever and Fulcrum.....	\$1 50	4909	Compound Bar.....	1 00
4115	Screw, in frame of cherry.....	2 50	4831	Spirit Lamp.....	.75
4113	Wedge, hinged.....	1 50	4700	Air Thermometer.....	25
—	Pulley and Weights.....	2 00	—	Glass Flask, pint.....	40
		\$7 50	—	Stand for Flask.....	50
HYDROSTATICS.			—	$\frac{1}{2}$ lb. Assorted Glass Tubing.....	30
4163	Set of Equilibrium Tubes, 6 forms..	\$3 50			\$8 45
—	Hydrometer.....	50	MAGNETISM, GALVANISM AND ELECTRICITY.		
—	" Jar.....	50	—	Geissler's Tube.....	\$0 75
4204	Siphon, of Glass.....	40	5480	Pint Grenet Battery.....	4 00
4238	Glass Lift Pump, with Conical Valves.....	2 00	5727	Ruhmkorff Induction Coil.....	8 00
4239	Glass Force Pump, with Conical Valves.....	2 00	5637	Electro-magnet, 3-inch.....	1 50
—	Bottle Imp.....	75	5141	Bar Magnet, 6-inch.....	50
4361	Water Hammer.....	1 00	5146	Magnetic Needle, on Stand.....	2 00
		\$10 65	5576	Gunpowder Cup.....	1 00
PNEUMATICS.			—	Queen's No. 1 Toepler-Holtz Elec- trical Machine, gives long and brilliant discharges, works in all weathers.....	25 00
4260	Air Pump.....	\$20 00	5311	Leyden Jar, quart.....	1 50
—	Receiver for Air Pump.....		5345	Discharger, with Rubber Handle...	2 25
4310	Hand and Bladder Glass.....	1 00	5275	Electrical Chime, 2 Bells.....	1 75
4315	Madgeburg Hemispheres, 4-inch....	5 50	5290	" " Flyer.....	1 25
—	Barometer Tube, Cup and Mercury, etc.....	2 00	5294	Metallic Plate, for Images.....	1 50
4355	Guinea and Feather Tube.....	7 00	5297	Pair Pith Images.....	75
		\$35 50			\$51 75
Properties of Matter.....		\$30 55			
Mechanics.....		7 50			
Hydrostatics.....		10 65			
Pneumatics.....		35 50			
Acoustics.....		30 50			
Optics.....		12 00			
Heat.....		8 45			
Magnetism, Galvanism and Electricity.....		51 75			
		\$186 90			
Boxing and Packing.....		3 50			
		\$190 40			
Price per set, complete.....		\$150 00			

This set is intended to supersede the ones commonly used, which are deficient both in quality and quantity. The above apparatus is of a strictly first-class character.



We have arranged this new set of apparatus expressly for use with the new edition of Steele's Physics. It is intended to supersede the ones commonly used, which are deficient both in quality and quantity. The above apparatus is of a strictly first-class character, being manufactured under our immediate supervision. The numbers given refer to our large Illustrated Catalogue of Physical Apparatus, those without numbers are specially adapted for the wants of this set.

We would call particular attention, not only to the excellent character of the above, collection of Apparatus and the improved forms of Electrical Machine, Air Pump, and other standard pieces, but also to the various novelties introduced, viz.:—Metre and Yard, Ruhmkorff's Induction Coil, Giessler's Tube, etc., and last but not least, Professor Crooke's wonderful Radiometer, which has awakened such intense interest among scientists everywhere.

**SET OF APPARATUS TO ILLUSTRATE AVERY'S ELEMENTS OF NATURAL PHILOSOPHY.**

(The figures at the left refer to paragraphs in the text-book.)

Professor Avery, the author of the above work, has carefully revised this set for us.

**Properties of Matter Sets.**

PARAGRAPH	No.
26. Metre and Yard, . . . .	
175. Fairbanks' Balance, . . . .	4028
35. Brass Weights, kilogramme to gramme, . . . .	4029
38. Inertia Apparatus, . . . .	4060
46. Cohesion Plates of glass, . . . .	4030
46. Adhesion Disc, . . . .	4033
For the six pieces, \$12.00.	

**Dynamics.**

70. Momentum Apparatus, . . . .	
74. Centrifugal Force Apparatus, . . . .	4078
83. Parallelogram of forces, . . . .	4101
95. Collision Balls of ivory, . . . .	4062
97. Apparatus to illustrate reflection of motion, . . . .	4069
111. Horseman to illustrate stable equilibrium, . . . .	
113. Equilibrium Figures, . . . .	4146
116. Leaning Tower, . . . .	4143
119. Guinea and Feather tube, . . . .	4355
122. Atwood's Machine, . . . .	4128
145. Pendulum Apparatus, . . . .	4125
For the eleven pieces, \$190.00.	

**Simple Machines.**

168. Simple Lever, . . . .	
179, 192. Illustration of Pulleys, Wheel and Axle Capstan, etc., . . . .	4103
185. Illustration of Wheel Work on stand, . . . .	
193. Inclined Plane, . . . .	4111
205. Wedge with hinge, . . . .	4113

PARAGRAPH	No.
208. Screw in Frame, . . . .	4115
210. Endless Screw, . . . .	
For the seven pieces, \$50.00.	

**Liquids.**

216. Apparatus to demonstrate the Equality of Pressure in all directions, . . . .	4162
222. Hydrostatic Bellows, . . . .	4293
223. Hydraulic Press, . . . .	4196
234. Paschal's Vases, . . . .	4166
235. Set Capillary Tubes, . . . .	4035
239. Archimedes Principle, . . . .	4172
250. Nicholson's Hydrometer, . . . .	4173
252. Universal Hydrometer for Liquids, both lighter and heavier than water, in case, —. Hydrometer Jar, . . . .	
254. Vessel for Spouting Fluids, . . . .	4221
261. Model of Water Wheels, overshot, undershot and Breast Wheel, . . . .	4032
264. Barker's Mill, . . . .	4235
For the twelve pieces, \$145.00.	

**Pneumatics.**

269. Rubber Bag for showing Tension of Gases, . . . .	4384
274. Apparatus for Torricelli's Experiment, . . . .	4251
279. Barometer, . . . .	
280. Aneroid Barometer, . . . .	
281. Baroscope, . . . .	4298
283. One dozen Bursting Squares, . . . .	4380
283. Wire Guard, . . . .	4381
283. Valve Cap, . . . .	4382
285. Marrotte's Law Apparatus, . . . .	4351

PARAGRAPH	No.
286. Marrotte's Law Apparatus for less than one Atmosphere, .	4353
288. Large Lever Air Pump, .	
292. (4) Bladder Glass, .	4311
293. (10) Mercury Shower Apparatus, .	4375
293. (9) Fountain in Vacuo, .	4320
293. (11) Upward Pressure Apparatus Weight Lifter, .	4385
293. (12) Magdeburg Hemispheres, .	4316
293. (13) Bacchus Illustrations, .	4325
294, 296. Lifting and Forcing Pumps, .	4242
301. Tantalus Cup, .	
For the nineteen pieces, \$240.00.	

### Magnetism.

302. Natural Magnet (Lodestone), .	5138
303. Horseshoe Magnet, .	5178
303. Bar Magnet, 6 inches, .	5141
314. Magnetic Needle on Stand, .	5146
314. Astatic Needle, .	5155
314. Dipping Needle, .	5149
318. Inclination Compass, .	5152
— Magnetic Needle, .	5148
321. Compound Horseshoe Magnets, .	5187
321. Rolling Armature Magnet, .	5186
For the ten pieces, \$65.00.	

### Frictional Electricity.

322. Glass Rod, .	5212
322. Shellac Rod, .	5213
322. Cat Skin, .	5215
324. Pith Ball Electroscopes, .	5223
331. Electroscopes, .	5225
338. Induction Globe, .	5222
340. 2 Induction Cylinders of brass, .	5221
342. Electrophones, .	5240
347. Dielectric Machine, .	5252
349. Holtz Electric Machine, .	5262
352. Condenser of Epinus, .	5335
357. Electrical Battery, .	5340
355. Discharger with rubber handles, .	5347
356. Leyden Jar with movable castings, .	5317
358. Biot's Hemisphere, .	5218
358. Hollow Sphere, .	5216
357. Faraday's Wire Cylinder, .	5217
358. Faraday's Bag, .	5219
371. (1) Electrical Chime, .	5277
371. (4) Image Plates, .	5295
371. (11) Electrical Orrery, .	5283
371. (10) Electrical Flyer, .	5290
371. (20) Electrical Bomb, .	5364
371. (23) Universal Discharger, .	5349

PARAGRAPH	No.
371. (29) Luminous Globe, .	5373
371. (28) Luminous Pane, .	5372
371. (29) Luminous Tube, .	5377
Electrical Pistol, .	5363

For the twenty-seven pieces, \$276.00.

### Voltaic and Thermo-Electricity.

383. Two Cells Grenet Battery, .	5482
390. Oersted's Apparatus, .	5535
391. Galvanometer, .	5540
392. Three Pole Helix, .	5633
392. Magic Circle, .	5645
393. Electro Magnet, .	5641
395. Telegraph Apparatus, .	5688
397. Water Decomposer, .	5601
399. Electroplating Apparatus, .	5608
404. Primary and Secondary Coils, .	5700
404. Primary and Secondary Coils, .	5701
410. Induction Coil, .	5737
371. (31) Geissler Tube, .	5805
371. (31) Geissler Tube, .	5806
414. Thermo-Electric Pile, .	4964
For the fifteen pieces, \$157.00.	

### Sound.

421. Tuning Fork with style, .	
424. Bell in Vacuo, .	4342
435. Gyroscope with toothed wheel, .	4563
439. Laws for Sound, .	4606
456. Four Diapasons forming perfect chord, .	4570
443. Diapasons $ut_3$ in unison with one of above, .	4572
— Set of Resonant Jars, .	4600
— Chord $Ut_3$ $Mi_3$ $Sol_3$ $Ut_4$ , .	
450. Savart's Bell and Resonator, .	4599
455. Sonometer, .	4676
469. Octave of Organ Pipes $Ut_3$ to $Ut_4$ , .	4655
— Siren of Cogniard La Tour, .	4560
For the twelve pieces, \$147.00.	

### Heat.

476. Thermometer, .	4931
482. Leslie Differential Thermometer, .	4926
484. Ball and Ring on Stand, .	4907
488. Maximum Density of Water Apparatus, .	4905
500. Density of Vapor Apparatus, .	5041
505. Culinary Paradox, .	5032
507. Marcet's Globe, .	
512. Liebig's Condenser, .	7090
525. Cast Iron Bottles for Freezing, .	5014
526. Cryophorus, .	5037

PARAGRAPH	No.
534. Tyndall's Apparatus for Specific Heat, . . . . .	5038
540. Apparatus to show the weak conductivity of water, . . . . .	5005
539. Conductometer, . . . . .	5001
555. Pair of Parabolic Reflectors, . . . . .	4982
563. Air Syringe of Glass, . . . . .	5012
534. Boiling Tube of Copper, . . . . .	5057
570. Model of Engine, . . . . .	5078

For the seventeen pieces, \$169.00.

**Light.**

591. Apparatus to illustrate laws of Reflection, . . . . .	6091
--	------

PARAGRAPH	No.
617. Illuminated Fountain, . . . . .	6100
621. Solid Flint Glass Prism, . . . . .	
622. Set of six Demonstration Lenses, . . . . .	
639. Newton's Disc, . . . . .	6190
659. Crouch's Histological Microscope, . . . . .	3100
663. Telescope, . . . . .	2313
666. Stereoscope, . . . . .	2379
667. New Table Polariscopes with graduations, similar to 6522, . . . . .	
673. Specimen Iceland Spar, . . . . .	

For the ten pieces, \$203.00.

Special Arrangements will be made with parties ordering this set complete

**EAST HIGH SCHOOL,**

CLEVELAND, OHIO, August 19, 1879.

TO ANY PERSON INTERESTED.

I have always found the apparatus furnished by JAMES W. QUEEN & Co., to be satisfactory in finish and in operation. If you buy of them, I doubt not that your experience will be like mine.

ELROY M. AVERY.

---

**TYNDALL'S SET OF ELECTRICAL APPARATUS.**

Set of Apparatus designed to accompany Tyndall's "Lessons in Electricity," consisting of fifty-seven separate pieces. Complete, in box packed ready for shipment, . . . . . \$65.00

## NEW NATURAL HISTORY CABINETS.

LIST OF (RAW AND MANUFACTURED) SPECIMENS CONTAINED IN THE NATURAL HISTORY CABINET OF THE VEGETABLE KINGDOM, FOR OBJECT LESSON TEACHING AND SCHOOL MUSEUMS, SYSTEMATICALLY ARRANGED IN ACCORDANCE WITH GRAY'S "HOW PLANTS GROW."

### I.—Exogenous Plants.

CRESS FAMILY.  
White Mustard Seed.  
Black Mustard Seed.  
Flour of Mustard.

MALLOW FAMILY.  
Raw Cotton.  
Cotton Yarn.  
Factory Cotton.  
Bleached Cotton.  
Printed Calico.  
Twilled Calico.  
Book Muslin.  
Cotton Cambric.  
Fancy Cotton Shirting.  
Cotton Bed-Ticking.  
Cottonade.  
Cotton Duck.  
Cotton Lace.  
Cotton Thread.  
Bookbinders' Cloth.  
Enameled Cloth.  
Cotton Paper.

LINDEN FAMILY.  
Basswood.  
Basswood Bark.  
Basswood Paper.

CAMELLIA FAMILY.  
Black Tea.  
Green Tea.

COCOA FAMILY.  
Cocoa Beans.  
Cocoa Nibs.  
Cocoa.  
Chocolate.

FLAX FAMILY.  
Flax.  
Linseed (Flax Seed).  
Linseed Meal.  
Linseed Cake.  
Linseed Oil.  
Flax Paper.  
Irish Linen.  
Linen Shirting.  
Linen Toweling.  
Linen Thread.  
Diaper.  
Brown Holland.

GRAPE FAMILY.  
Raisins.  
Currants.  
Tartaric Acid.  
Cream Tartar.  
Port Wine.

SOAPBERRY FAMILY.  
Horse Chestnut.  
Maple.  
Maple Sugar.

PULSE FAMILY.  
Liquorice Root.  
Liquorice Juice.  
Gum Acacia.  
Senna Leaves.  
Brazil Wood.  
Logwood.  
Extract of Logwood.  
Indigo.  
Beans.  
Peas.  
Ground Nuts (or Pea Nuts).

ROSE FAMILY.  
Almond.  
Cherry.

MYRTLE FAMILY.  
Cloves.  
Allspice.  
Brazil Nut.

PARSLEY FAMILY.  
Caraway Seeds.

SUNFLOWER FAMILY.  
Chamomile Flowers.  
Chicory Root.  
Ground Chicory.

MADDER FAMILY.  
Coffee Beans, Raw.  
Coffee Beans, Roasted.  
Ground Coffee.

SAGE OR MINT FAMILY.  
Horehound.

NIGHTSHADE FAMILY.  
Starch.  
Tobacco.

OLIVE FAMILY.  
Ash.  
Olive Oil.  
Manna.

SAPPODILLA FAMILY.  
Gutta Percha, Raw.  
Gutta Percha, Prepared.

BUCKWHEAT FAMILY.  
Buckwheat.  
Buckwheat Flour.  
Rhubarb.

LAUREL FAMILY.  
Cinnamon.  
Camphor.

SPURGE FAMILY.  
Ipecacuhana.  
Castor Oil Bean.  
Castor Oil.  
Tapioca.

NUTMEG FAMILY.  
Nutmeg.  
Mace.

NETTLE FAMILY.  
Hemp Seed.  
Hemp.  
Hemp Cord.  
Hemp Matting.  
Hops.  
Fig.  
India Rubber, Raw.  
India Rubber, Prepared.

PEPPER FAMILY.  
White Pepper.  
Black Pepper.  
Long Pepper.  
Ground Pepper.

WALNUT FAMILY.  
Butternut Wood.  
Butternut.  
Hickory Wood.  
Hickory Nut.  
English Walnut.  
Walnut.  
Walnut Wood.

### OAK FAMILY.

Acorn.  
Oak Bark.  
Oak Wood.  
Oak Galls.  
Beech.  
Chestnut.  
Chestnut Wood.  
Corks.  
Hazlenut.

### BIRCH FAMILY.

Birch.

### WILLOW FAMILY.

Willow.  
Poplar.

### PINE FAMILY.

Pine.  
Charcoal.  
Canada Balsam.  
Turpentine.  
Resin.  
Sealing Wax.  
Pitch.  
Tar.

### II.—Endogenous Plants.

SARSAPARILLA FAMILY.  
Sarsaparilla.

PALM FAMILY. ]  
Sago.

IRIS FAMILY.  
Saffron.

RUSH FAMILY.  
Esparto Grass Paper.

LILY FAMILY.  
Aloes.

GRASS FAMILY.  
Rice.  
Rye.  
Barley.  
Barley Meal.  
Pot Barley.  
Malt.  
Vinegar.  
Wheat.  
Wheat Flour.  
Bran.  
Straw.  
Straw Paper.  
Straw Board.  
Straw Plant.  
Biscuit.  
Maccaroni.  
Oats.  
Oatmeal.  
Maize.  
Maize Flour.  
Hominy.  
Canary Seed.  
Sugar Cane.  
Loaf Sugar.  
Sugar Candy.  
Brown Sugar.  
Molasses.

GINGER FAMILY.  
Ginger Root.  
Ground Ginger.  
Cardamom Seeds.

ARROWROOT FAMILY.  
Arrowroot.

The above will be found very useful in the study of Botany. They are neatly arranged in stained wood case, containing four trays. Price, complete, . . . . . \$15.00

**QUEEN'S NEW CHEMICAL SET. No. I.**

This set has been carefully selected for the use of common schools. It contains all the chemicals necessary for the performance of nearly all the experiments mentioned in any elementary work on Chemistry. The chemicals are put up in flint-glass bottles, labeled with both the old and the new nomenclature. The apparatus is of the best quality.

Price, complete, in box.....\$15.00

	SYMBOLS.		SYMBOLS.
2 oz. Acid Acetic.....	$HC_2H_3O_2$	1 dr. Gun Cotton.....	$C_6H_8N_2O_2O_5$
1 lb. " Hydrochloric .....	$HCl$	1 " Iodine.....	$I$
1 " " Nitric.....	$HNO_3$	1 oz. Lead Acetate.....	$Pb(C_2H_3O_2)_2$
2 " " Sulphuric.....	$H_2SO_4$	2 dr. Litmus .....	—
1 oz. " Oxalic.....	$H_2C_2O_4$	2 oz. Mercury.....	$Hg$
$\frac{1}{2}$ " " Tartaric.....	$H_2C_4H_4O_6$	6 in. Magnesium Ribbon.....	$Mg$
2 " Ammonium Chloride.....	$AmCl$	2 oz. " Sulphate.....	$MgSO_4$
4 " " Hydrate .....	$AmHO$	1 lb. Manganese Dioxide.....	$MnO_2$
1 " " Nitrate.....	$AmNO_3$	1 ft. Platinum Wire.....	$Pt$
1 " " Sulphide.....	$AmHS$	2 dr. Phosphorus ..	$P$
$\frac{1}{2}$ " Animal Charcoal.....	$C$	$\frac{1}{4}$ " Potassium (metallic).....	$K$
$\frac{1}{2}$ " Antimony .....	$Sb$	1 oz. " Bichromate ....	$K_2Cr_2O_7$
1 " Alum.....	$Al_2SO_4Am_2SO_424H_2O$	2 " " Chlorate .....	$KClO_3$
8 " Alcohol .....	$C_2H_5HO$	2 " " Ferrocyanide... $K_4FeCy_6$	
1 " Barium Chloride.....	$BaCl_2$	1 " " Hydrate.....	$KHO$
1 " " Nitrate.....	$Ba_2NO_3$	1 " " Nitrate.....	$KNO_3$
2 " Calcium Carbonate.....	$CaCO_3$	1 " Strontium Chloride .....	$SrCl_2$
2 " " Fluoride.....	$CaF_2$	1 " " Nitrate.....	$Sr_2NO_3$
4 " " Sulphate.....	$CaSO_4$	4 " Sulphur.....	$S$
1 " Carbon Bisulphide.....	$CS_2$	1 dr. Silver Nitrate .....	$AgNO_3$
1 " Charcoal .....	$C$	1 " Sodium (metallic).....	$Na$
2 " Copper Sulphate.....	$CuSO_4$	1 oz. " Biborate. $2NaBO_2B_2O_310H_2O$	
2 " Ether .....	$(C_2H_5)_2O$	1 " " Carbonate.....	$Na_2CO_2$
1 " Ferrous Sulphide.....	$FeS$	1 " " Sulphate.....	$Na_2SO_4$
2 " " Sulphate .....	$FeSO_4$	Zinc for making Hydrogen.....	$Zn$
$\frac{1}{2}$ " Gall Nuts.....	—		

**CHEMICAL APPARATUS.**

Beakers  
Blow-pipe.  
Chemical Flask.  
Hessian Crucibles (nest).  
Deflagrating Spoon.  
Evaporating Dish.  
Evolution Flask (fitted) for making Hydrogen, Carbonic Acid Gas, etc.  
 $\frac{1}{4}$  qr. Filtering Paper.  
File.  
Glass Funnel.  
English Graduate.

Chemical Glass Tubing (assorted).  
Lead Dish.  
Pipette Retort.  
Rubber Tubing.  
Sand Bath.  
Spirit Lamp.  
Specie Jar for Deflagration.  
Test-tubes.  
Test-tube Holder.  
" Brush.  
Wedgewood Mortar.

### QUEEN'S NEW CHEMICAL SET. No. 2.

We recommend this set to those who make a special branch of Chemistry. It contains salts of all the most important elements, and is amply sufficient to accompany a course through any of the Academic Text-books on Chemistry.

Price, complete.....\$25.00

	SYMBOLS.		SYMBOLS.
$\frac{1}{4}$ lb. Acetic Acid.....	$\text{HC}_2\text{H}_3\text{O}_2$	12 in. Magnesium Ribbon.....	Mg
1 " Hydrochloric Acid.....	HCl	2 oz. " Sulphate.....	$\text{MgSO}_4$
1 " Nitric " .....	$\text{HNO}_3$	$\frac{1}{4}$ lb. Manganese Dioxide.....	$\text{MnO}_2$
1 oz. Oxalic " .....	$\text{H}_2\text{C}_2\text{O}_4$	2 oz. Mercury .....	Hg
2 lbs. Sulphuric " .....	$\text{H}_2\text{SO}_4$	2 drs. Mercuric Chloride.....	$\text{HgCl}_2$
1 oz. Tartaric " .....	$\text{H}_2\text{C}_4\text{H}_4\text{O}_6$	2 " " Oxide .....	$\text{HgO}$
1 " Ammonium Carbonate.....	$\text{Am}_2\text{CO}_3$	12 in. Platinum Wire. ....	Pt
2 " " Chloride.....	AmCl	$\frac{1}{2}$ oz. Phosphorus .....	P
$\frac{1}{4}$ lb. " Hydrate.....	AmHO	$\frac{1}{2}$ dr. Potassium (metallic).....	K
1 oz. " Nitrate .....	$\text{AmNO}_3$	$\frac{1}{4}$ lb. " Bichromate....	$\text{K}_2\text{Cr}_2\text{O}_7$
1 " " Sulphide.....	AmHS	2 " " Carbonate.....	$\text{K}_2\text{CO}_3$
$\frac{1}{2}$ pt. Alcohol.....	$\text{C}_2\text{H}_5\text{HO}$	$\frac{1}{2}$ " " Chlorate .....	$\text{KClO}_3$
2 oz. Alum....	$\text{Al}_2\text{SO}_4\text{Am}_2\text{SO}_4\text{24H}_2\text{O}$	1 oz. " Chromate.....	$\text{K}_2\text{CrO}_4$
2 " Animal Charcoal.....	C	$\frac{1}{2}$ " " Cyanide.....	KCy
$\frac{1}{2}$ " Antimony.....	Sb	1 " " Ferricyanide... $\text{K}_6\text{Fe}_2\text{Cy}_{12}$	
1 " Arsenious Anhydride.....	$\text{As}_2\text{O}_3$	2 " " Ferrocyanide... $\text{K}_4\text{FeCy}_6$	
1 " Barium Chloride.....	$\text{BaCl}_2$	1 " " Hydrate.....	KHO
1 " " Nitrate .....	$\text{Ba}_2\text{NO}_3$	1 dr. " Iodide.....	KI
1 " Borax.....	$2\text{NaBO}_2\text{B}_2\text{O}_3\text{10}_2\text{HO}$	2 oz. " Nitrate.....	$\text{KNO}_3$
$\frac{1}{4}$ lb. Calcium Carbonate.....	$\text{CaCO}_3$	2 drs. " Permanganate... $\text{K}_2\text{Mn}_2\text{O}_8$	
2 oz. " Chloride. ....	$\text{CaCl}_2$	1 oz. " Sulphate.....	$\text{K}_2\text{SO}_4$
2 " " Fluoride.....	$\text{CaFl}_2$	1 dr. Silver Nitrate.....	$\text{AgNO}_3$
$\frac{1}{4}$ lb. " Sulphate.....	$\text{CaSO}_4$	1 " Sodium (metallic) .....	Na
1 oz. Carbon Bisulphide... ..	$\text{CS}_2$	$\frac{1}{2}$ oz. " Acetate.....	$\text{NaC}_2\text{H}_3\text{O}_2$
1 " Cobalt Nitrate.....	$\text{Co}_2\text{NO}_3$	2 " " Carbonate.....	$\text{Na}_2\text{CO}_3$
4 " Copper Sulphate.....	$\text{CuSO}_4$	1 " " Hydrate.....	NaHO
2 " Ether. ....	$(\text{C}_2\text{H}_5)_2\text{O}$	2 " " Hyposulphite..... $\text{Na}_2\text{S}_2\text{O}_3\text{5H}_2\text{O}$	
2 " Ferrous Sulphate.....	$\text{FeSO}_4$	2 " " Sulphate.....	$\text{Na}_2\text{SO}_4$
1 " " Sulphide .....	FeS	1 " Strontium Chloride... ..	$\text{SrCl}_2$
2 drs. Gall Nuts.....	—	1 " " Nitrate.....	$\text{Sr}_2\text{NO}_3$
1 " Gun Cotton.....	$\text{C}_6\text{H}_8\text{2NO}_2\text{O}_5$	$\frac{1}{4}$ lb. Sulphur .....	S
1 " Iodine.....	I	$\frac{1}{2}$ " Zinc for making Hydrogen.....	Zn
1 oz. Lead Acetate.....	$\text{Pb}(\text{C}_2\text{H}_3\text{O}_2)_2$		
2 " " Carbonate.....	$\text{PbCO}_3$		
2 " " Monoxide.....	PbO		
2 drs. Litmus (best cubes).....	—		

### CHEMICAL APPARATUS.

Beakers (nest of 4).  
 Jewelers' Blow-pipe.  
 5 Hessian Crucibles.  
 Chemical Flask.  
 Deflagrating Spoon.  
 Evaporating Dish.  
 Evolution Flask, fitted with funnel and delivery tubes, complete for making Hydrogen, Carbonic Acid Gas, etc.  
 File.  
 $\frac{1}{2}$  qr. Filtering Paper.  
 8-oz. Funnel.  
 2-oz. " "  
 Graduate.  
 $\frac{1}{2}$  lb. assorted Glass Tubing.  
 1 gal. Gas-bag and Stopcock.

Lead Dish, for Hydrofluoric Acid.  
 Pneumatic Trough.  
 Pipette.  
 Retort.  
 " Stand. (iron rings).  
 Rubber Tubing.  
 Sand Bath.  
 Scales and Weights.  
 Spirit Light.  
 Specie Jar for Deflagration.  
 1 doz. Test-tubes.  
 Test-tube Holder.  
 " Cleaner.  
 Wire Gauze.  
 Wedgewood Mortar and Pestle.

**QUEEN'S CHEMICAL SET. No. 3.**

This set is a *complete* Laboratory. It has been specially arranged for the use of High Schools and Colleges. The chemicals are furnished in quantities sufficient to fill a large cabinet. The apparatus is all first-class and the same as is used in the Laboratories of the leading Universities.

Price, complete.....\$50.00

	SYMBOLS.		SYMBOLS.
1 lb. Acid Acetic.....	$\text{HC}_2\text{H}_3\text{O}_2$	1 oz. Gall Nuts.....	—
$\frac{1}{4}$ " " Boracic.....	$\text{H}_3\text{BO}_3$	1 dr. Gun Cotton.....	$\text{C}_6\text{H}_8\text{N}_2\text{O}_5$
2 oz. " Citric.....	$\text{H}_3\text{C}_6\text{H}_5\text{O}_7$	1 oz. Indigo Solution.....	—
2 lbs. " Hydrochloric.....	$\text{HCl}$	$\frac{1}{2}$ lb. Iron Filings.....	$\text{Fe}$
2 " " Nitric.....	$\text{HNO}_3$	$\frac{1}{4}$ " Lead Acetate.....	$\text{Pb}_2\text{C}_2\text{H}_3\text{O}_2$
1 " " Oxalic.....	$\text{H}_2\text{C}_2\text{O}_4$	1 " " Carbonate.....	$\text{PbCO}_3$
4 " " Sulphuric.....	$\text{H}_2\text{SO}_4$	$\frac{1}{4}$ " " Nitrate.....	$\text{Pb}_2\text{NO}_3$
$\frac{1}{4}$ " " Tartaric.....	$\text{H}_2\text{C}_4\text{H}_4\text{O}_6$	1 lb. Lead Protoxide.....	$\text{PbO}$
1 pt. Alcohol Ethylic.....	$\text{C}_2\text{H}_5\text{HO}$	1 oz. Litmus (best cubes).....	—
1 " " Methylic.....	$\text{CH}_3\text{HO}$	2 " Logwood.....	—
1 lb. Alum Alumina et Ammoni Sulph.,	$\text{Al}_2\text{SO}_4\text{Am}_2\text{SO}_4\text{24HO}$	12 in. Magnesium Ribbon.....	$\text{Mg}$
1 pt. Aqua Ammonia.....	$\text{AmHO}$	2 oz. " Chloride.....	$\text{MgCl}_2$
$\frac{1}{2}$ lb. Ammonium Carbonate.....	$\text{Am}_2\text{CO}_3$	1 lb. " Sulphate.....	$\text{MgSO}_4$
1 " " Chloride.....	$\text{AmCl}$	2 lbs. Manganese Dioxide.....	$\text{MnO}_2$
1 oz. " Molybdate test, for		4 oz. Mercury.....	$\text{Hg}$
Phosphoric Acid.....	$\text{Am}_2\text{MoO}_4$	1 " Mercuric Chloride.....	$\text{HgCl}_2$
$\frac{1}{2}$ lb. Ammonium Nitrate.....	$\text{AmNO}_3$	1 " " Oxide.....	$\text{HgO}$
1 oz. " Oxalate.....	$\text{Am}_2\text{C}_2\text{O}_4$	1 " Microcosmic Salt.....	$\text{NaNH}_4\text{HPO}_4$
1 lb. " Sulphate.....	$\text{Am}_2\text{SO}_4$	$\frac{1}{2}$ lb. Paraffine.....	—
2 oz. " Sulphide.....	$\text{AmHS}$	12 in. Platinum Wire.....	$\text{Pt}$
$\frac{1}{2}$ dr. Aniline.....	—	1 " " Sponge.....	$\text{Pt}$
1 lb. Animal Charcoal.....	$\text{C}$	1 oz. Phosphorus.....	$\text{P}$
1 oz. Antimony (metallic).....	$\text{Sb}$	4 " Plumbago.....	$\text{C}$
2 " " Sulphide.....	$\text{Sb}_2\text{S}_3$	1 dr. Potassium (metallic).....	$\text{K}$
$\frac{1}{2}$ " Arsenicum (metallic).....	$\text{As}$	1 lb. " Bichromate (red),	$\text{K}_2\text{Cr}_2\text{O}_7$
$\frac{1}{4}$ lb. Arsenious Anhydride.....	$\text{As}_2\text{O}_3$	$\frac{1}{2}$ " " Carbonate.....	$\text{K}_2\text{CO}_3$
1 oz. Asbestos.....	—	1 " " Chlorate.....	$\text{KClO}_3$
2 " Barium Carbonate.....	$\text{BaCO}_3$	2 oz. " Chromate (yellow),	$\text{K}_2\text{CrO}_4$
$\frac{1}{2}$ lb. " Chloride.....	$\text{BaCl}_2$	1 " " Cyanide.....	$\text{KC}_y$
$\frac{1}{3}$ " " Nitrate.....	$\text{Ba}_2\text{NO}_3$	1 " " Ferricyanide, $\text{K}_6\text{Fe}_2\text{Cy}_{12}$	
1 " " Sulphate.....	$\text{BaSO}_4$	$\frac{1}{4}$ lb. " Ferrocyanide, $\text{K}_4\text{FeCy}_6$	
$\frac{1}{2}$ dr. Bismuth.....	$\text{Bi}$	$\frac{1}{2}$ oz. " Hydrate (sticks), $\text{KHO}$	
$\frac{1}{2}$ lb. Bone Ash.....	—	2 dr. " Iodide.....	$\text{KI}$
$\frac{1}{2}$ " Calcium Carbonate.....	$\text{CaCO}_3$	$\frac{1}{2}$ " " Nitrate.....	$\text{KNO}_3$
1 " " Chloride.....	$\text{CaCl}_2$	1 oz. " Permanganate,	$\text{K}_2\text{Mn}_2\text{O}_8$
1 " " Fluoride.....	$\text{CaFl}_2$	4 " " Silicate.....	$\text{K}_2\text{S}_2\text{O}_3$
1 " " Sulphate.....	$\text{CaSO}_4$	$\frac{1}{2}$ lb. " Sulphate.....	$\text{K}_2\text{SO}_4$
2 oz. Carbon Bisulphide.....	$\text{CS}_2$	2 dr. " Sulphocyanide, $\text{KCNS}$	
$\frac{1}{2}$ lb. Charcoal.....	$\text{C}$	1 oz. " Bi-Tartrate, $\text{KHC}_4\text{H}_4\text{O}_6$	
2 oz. Cobalt Chloride, sol.....	$\text{CoCl}_2$	1 dr. Silver Nitrate, C. P.....	$\text{AgNO}_3$
2 " " Nitrate, sol.....	$\text{Co}_2\text{NO}_3$	2 " Sodium (metallic).....	$\text{Na}$
Copper Foil.....	$\text{Cu}$	1 oz. " Acetate.....	$\text{NaC}_2\text{H}_3\text{O}_2$
1 " " Nitrate.....	$\text{Cu}_2\text{NO}_3$	$\frac{1}{2}$ lb. " Biborate.....	$2\text{NaBO}_2\text{B}_2\text{O}_3$
1 lb. " Sulphate.....	$\text{CuSO}_4$	1 oz. " Bromide.....	$\text{NaBr}$
$\frac{1}{4}$ pt. Ether.....	$(\text{C}_2\text{H}_5)_2\text{O}$	1 lb. " Bicarbonate.....	$\text{HNaCO}_3$
2 oz. Ferric Chloride.....	$\text{Fe}_2\text{Cl}_6$	2 " " Carbonate.....	$\text{Na}_2\text{CO}_3$
1 lb. Ferrous Sulphate.....	$\text{FeSO}_4$		
$\frac{1}{4}$ " " Sulphide.....	$\text{FeS}$		

	SYMBOLS.		SYMBOLS.
1 lb. Sodium Hydrate.....	NaHO	2 lbs. Sulphur .....	S
2 " " Hyposulphite,		$\frac{1}{4}$ " Tin (metallic).....	Sn
	$\text{Na}_2\text{S}_2\text{O}_3 \cdot 5\text{H}_2\text{O}$	1 oz. " Proto Chloride.....	$\text{SnCl}_2$
1 " " Nitrate .....	$\text{NaNO}_3$	1 pt. Turpentine .....	$\text{C}_{10}\text{H}_{16}$
$\frac{1}{4}$ " " Phosphate.....	$\text{Na}_2\text{HPO}_4$	1 lb. Zinc Mossy, for making Hydro-	
1 " " Silicate .....	$\text{Na}_2\text{SiO}_3$	gen.....	Zn
1 " " Sulphate.....	$\text{Na}_2\text{SO}_4$	1 " " Carbonate.....	$\text{ZnCO}_3$
$\frac{1}{2}$ " Strontium Carbonate.....	$\text{SrCO}_3$	$\frac{1}{4}$ " " Oxide.....	$\text{ZnO}$
$\frac{1}{4}$ " " Chloride.....	$\text{SrCl}_2$	1 " " Sulphate.....	$\text{ZnSO}_4$
$\frac{1}{2}$ " " Nitrate.....	$\text{Sr}(\text{NO}_3)_2$		

### CHEMICAL APPARATUS.

Alcohol Lamp.  
 1 lb. assorted Glass Tubing.  
 2 doz. assorted Test-tubes.  
 2 " " Corks.  
 Nest of 6 Beakers, 3 to 18 oz.  
 Brass Blow-pipe.  
 Set of 3 Brass Cork Borers.  
 Cork Screw.  
 2 nests of 5 Hessian Crucibles.  
 1 pair Crucible Tongs.  
 1-pt. Chemical Flask.  
 2 4-oz. " "  
 " Thermometer.  
 " Balance and Weights.  
 Brass Deflagrating Spoon.  
 1 2-oz. Evaporating Dish.  
 1 10-oz. " "  
 Evolution Flask, with funnel and delivery tubes, rubber connection, etc., complete, for making Hydrogen.  
 Carbonic Acid Gas, etc.  
 Triangular File.  
 Round " "  
 1 package of 100 cut Filters.  
 1-pt. Glass Funnel.  
 1 4-oz. " "  
 " Syphon.  
 Metric Graduate Glass.

English Graduate Glass.  
 1-gal. Gas-bag, with brass Stopcock, fitted.  
 Hydrometer, for taking specific gravity.  
 Jar for Hydrometer.  
 Lead Dish for Hydrofluoric Acid.  
 Pipette.  
 Pneumatic Trough of Japanned tin.  
 1-pt. Retort.  
 Receiver for Retort.  
 Iron Retort Stand.  
 Rubber Tubing for gas connections.  
 Reduction Tube for reducing metallic oxides.  
 Polished-steel Spatula.  
 3 Glass Stirring Rods.  
 Sand Bath.  
 2 Specie Jars for collecting Gases and for Deflagration.  
 Test Glass.  
 Test-tube Rack.  
 " Holder.  
 " Cleaner.  
 Watch-spring for burning in Oxygen.  
 Welter's Safety Tubes.  
 Iron Wire Gauze.  
 Woulf Bottle with 3 necks.  
 4-in. Wedgewood Mortar and Pestle.

These sets are put up in our own Laboratory. The chemicals are all pure and fresh, and put up in suitable bottles, labeled with both the old and new nomenclature.





# CATALOGUE

OF

## SCIENTIFIC BOOKS AND WORKS OF REFERENCE.

Suited to the Needs of the Student, the Teacher and the Physicist.

### GENERAL PHYSICS.

	PRICE
ARNOTT'S ELEMENTS OF PHYSICS.....	\$3.00
AVERY'S NATURAL PHILOSOPHY. By Elroy M. Avery.....	1.10
COOLEY'S ELEMENTARY PHILOSOPHY.....	72
—— NATURAL PHILOSOPHY.....	90
DESCHANEL'S NATURAL PHILOSOPHY. 4 Parts. Cloth. Each.....	1.60
—— Complete in 1 vol., 8vo, cloth.....	5.70
DRAPER'S NATURAL PHILOSOPHY ENGRAVINGS. By J. W. Draper. 12mo, sheep.....	1.50
FRICK'S PHYSICAL TECHNICS, or Practical Instructions for making Experi- ments in Physics. By J. Frick. 1 vol., 8vo, cloth.....	2.50
GANOT'S ELEMENTARY TREATISE ON PHYSICS, Experimental and Applied. By A. Ganot. Translated from the last French edition by Dr. Atkinson, F. C. S. Post, 8vo. New York, 1869.....	5.00
GUILLEMIN'S FORCES OF NATURE. A popular Introduction to the study of Physical Phenomena. By Amedee Guillemin. Translated from the French by Mrs. Norman Lockyer, and edited, with additions and notes, by J. Norman Lockyer, F. R. S. Royal 8vo, cloth. Illustrated by 11 colored plates, and 455 wood-cuts. London, 1872.....	6.50
—— The Applications of Physical Forces. Translated from the French by Mrs. Norman Lockyer, and edited, with additions and notes, by J. Norman Lockyer, F. R. S., with plates, and nearly 500 engravings. Royal 8vo.....	8.00
JAMIN COURS DE PHYSIQUE DE L'ECOLE POLYTECHNIQUE. By M. J. Jamin. 8vo, paper, 4 vols. Paris, 1868-75.....	14.20
JAMIN'S PETIT TRAITE DE PHYSIQUE. Par M. J. Jamin. 8vo, paper, with 686 illustrations. Paris, 1870.....	3.20
LARDNER. Hand-book of Natural Philosophy. By D. Lardner, D. C. L. Mechanics. 1 vol. 12mo, cloth. London, 1866.....	2.00

	PRICE
LARDNER. Hand-book of Natural Philosophy. By D. Lardner, D. C. L. Electricity, Magnetism and Acoustics. Edited by G. C. Foster, B. A. 1 vol. 12mo, cloth. London, 1868.....	\$2.00
—— Hand-book of Natural Philosophy. By D. Lardner, D. C. L. Hydrostatics, Pneumatics and Heat. 1 vol. 12mo, cloth. London, 1865.....	2.00
—— Hand-book of Natural Philosophy. By D. Lardner, D. C. L. Optics. Edited by T. O. Harding, B. A. 1 vol. 12mo, cloth. London, 1869.....	2.00
MAYER'S LECTURE NOTES ON PHYSICS. By Alfred M. Mayer, Ph. D. 1 vol 8vo, cloth.....	2.00
SILLIMAN'S FIRST PRINCIPLES OF PHYSICS, OR NATURAL PHILOSOPHY. By Benj. Silliman. 8vo.....	3.50
STEELE, fourteen weeks in Philosophy. By J. Norman Steele.....	1.00
STEINMETZ'S PHILOSOPHICAL AND OTHER INSTRUMENTS USED IN THE INVESTIGATION OF SCIENCE, the mechanical arts, and for purposes of general utility. Their principles, construction and uses concisely explained. By Andrew Steinmetz, (in Press).....	

### MECHANICS.

ABEL. Rudimentary and Elementary Principles of the Construction and on the Working of Machinery. By C. D. Abel, C. E. (Weal's Series.).....	3.30
ALEXANDER'S DICTIONARY OF WEIGHTS AND MEASURES, Ancient and Modern, reduced to the U. S. of America standards. By J. H. Alexander, new edition. 8vo, cloth.....	3.50
APPLEBY'S ILLUSTRATED HAND-BOOK OF MACHINERY. Section 1st., prime movers, including fixed and portable Engines, Locomotives, Air, Gas and Water Engines, Water Wheels, etc., etc. By C. J. Appleby. 8vo, cloth...	80
—— Section 2d. Hoisting Machinery, including Winding Engines, Hydraulic, Steam and Hand Cranes, etc. 8vo, cloth.....	1.50
—— Section 3d. Pumping Machinery, including Pumping Engines, Centrifugal, Steam and Hand Pumps, etc.....	1.50
BARNARD'S METRIC SYSTEM OF WEIGHTS AND MEASURES. By F. A. P. Barnard. Second edition. 8vo, cloth.....	3.00
BARTLETT'S SYNTHETIC MECHANICS.....	3.50
—— ANALYTICAL MECHANICS.....	3.50
BENET'S CHRONOSCOPE, Electro-Ballistic Machines, and the Schultz Chronoscope. By Col. S. V. Benet, U. S. A. Illustrated 4to, cloth.....	3.00
BROWN'S FIVE HUNDRED AND SEVEN MECHANICAL MOVEMENTS, embracing all those which are most important in Dynamics, Hydraulics, Hydrostatics, Pneumatics, Steam Engines, Mill and other gearing Presses, Horology and miscellaneous Machinery. By Henry T. Brown, editor of American Artisan.....	1.00
CLARKE'S WEIGHTS, MEASURES AND MONEY OF ALL NATIONS. Compiled by F. W. Clarke, S. B., Prof. Physics and Chemistry in University of Cincinnati. 1 vol., 12mo, half bd.....	1.50
COLIN. The Universal Metric System. 12mo, cloth.....	50
CRAIG'S DECIMAL SYSTEM, with Table of Conversion for Commercial and Scientific uses. By B. F. Craig, M. D. Square 32mo, limp.....	50

	PRICE
FERGUSON. Lectures on Select Subjects in Mechanics, Pneumatics, Hydrostatics and Optics, with the Use of the Globes. The Art of Dialing. By James Ferguson, F. R. S. 8vo, cloth, with numerous plates. London, 1839.....	\$4.00
GOODEVE'S MECHANISM.....	1.50
KNIGHT, THE MECHANICIAN AND CONSTRUCTOR, comprising Forging, Planing, Lining, Slotting, Shaping, Turning, Screw-cutting, etc. By Cameron Knight. Illustrated by 96 4to plates, containing 1147 illustrations, and 397 pages of letter-press. 4to, cloth.....	15.00
MAXWELL. Matter and Motion. By J. Clerk Maxwell, M. A. With Illustrations. (Van Nostrand's Science Series, No. 36.) 16mo, boards. New York, 1878.....	50
MICHAELIS. The le Boulenge Chronograph, with three Lithographed folding plates of Illustrations. By Captain O. E. Michaelis, U. S. A. 4to. Illustrated. Cloth.....	3.00
NEWDIGATE, (A. L.). Scales for the ready comparison of British and metric weights and measures, in neat cloth case.....	2.00
PARKINSON. An Elementary Treatise on Mechanics. By S. Parkinson, M. D. Third edition, revised. 1 vol. 12mo, cloth.....	2.40
PEIRCE'S ANALYTIC MECHANICS. By Benjamin Peirce, Professor of Astronomy and Mathematics in Harvard University. 4to, cloth.....	10.00
RANKINE. Applied Mechanics. 12mo, cloth.....	5.00
—— A Mechanical text-book, or introduction to the study of Mechanics. By Prof. Rankine and E. F. Baucher, C. E.....	4.50
TAIT. A Treatise on the Dynamics of a particle. By Peter Guthrie Tait, M. A., and the late John Steele, B. A. Fourth edition, revised. 12mo.....	2.75
TODHUNTER'S KEY TO MECHANICS FOR BEGINNERS. By I. Todhunter, M. A., F. R. S. 12mo.....	1.75
WEISBACH. A Manual of Theoretical Mechanics. By Julius Weisbach, Ph. D. 1,100 pages, and 902 wood-cut illustrations. Revised, 8vo, cloth.....	10.00
WILLIS'S PRINCIPLES OF MECHANISM, for the use of Students in the Universities. By Robert Willis, M. A., F. R. S. 8vo, cloth.....	7.50

### HYDRAULICS AND HYDROSTATICS.

BEARDMORE. Manual of Hydrology, containing Hydraulic and other tables. By Nathaniel Beardmore, C. E.....	12.00
CULLEN (William). A Practical Treatise on the Construction of Horizontal and Vertical Water Wheels, with 11 plates. By William Cullen, Millwright. Revised and enlarged. Small 4to, cloth.....	5.00
DONALDSON. Principles of Construction and Efficiency of Water Wheels. By William Donaldson, M. A., Assoc. Inst. C. E.....	2.00
FRANCIS (LOWELL). Hydraulic Experiments on Hydraulic Motors, flow of water over weirs, in open canals of uniform rectangular sections, and through submerged orifices and diverging tubes. Made at Lowell, Mass., by James B. Francis, C. E. New edition, revised and enlarged; plates. 4to, cloth.....	15.00

	PRICE
GLYNN. Treatise on the Power of Water, as applied to drive Flour Mills and to give motion to Turbines and other Hydrostatic Engines. By Joseph Glynn, F. R. S., Member of the Institute of Civil Engineers, London, etc. Third edition, revised and enlarged, with numerous illustrations. 1 vol. 12mo, cloth. New York, 1869.....	\$0.80
HICKS (John). Experiments on the Friction of Leather Collars in Hydraulic Presses. By John Hicks, C. E. Plates; 8vo. Sewed.....	40
MILLER. The Elements of Hydrostatics and Hydrodynamics. By W. H. Miller, M. A. 1 vol. 8vo, boards. Cambridge, 1831.....	2.75
TREDGOLD. Tracts on Hydraulics. Edited by Thomas Tredgold, C. E. London, 1862.....	2.50

### ASTRONOMY AND METEOROLOGY.

AIRY. Popular Astronomy. A series of lectures delivered at Ipswich, by G. B. Airy. Sixth edition, revised. London, 1868. 1 vol. 16mo.....	1.50
BARTLETT'S SPHERICAL ASTRONOMY.....	3.50
BLODGETT. Climatology of the United States and of the Temperate Latitudes of the North American Continent, etc., etc., with isothermal charts. By L. Blodgett. Royal 8vo.....	5.00
BUCHAN. A Handy Book of Meteorology. By Alexander Buchan, M. A. 1 vol. 12mo, cloth. (New edition, in press.)	
—— Introductory Text-Book of Meteorology. By Alexander Buchan. 12mo, cloth. Illustrated.....	2.25
CARRINGTON. Observations of the Spots on the Sun, from November 9, 1853, to March 24, 1861. Made at Redhill, by Richard C. Carrington. Illustrated by 166 plates. 1 vol. 4to. London, 1863.....	12.50
CHAMBERS. Descriptive Astronomy. By George T. Chambers, F. R. A. S. Third edition. 8vo, cloth. Oxford, 1877.....	10.00
CHAUBRIAND. Etude sur L'eclipse Totale de Soliel, du 18 Aout 1868. Par L'Chaubriand. 8vo, paper.....	60
CHAUVENET (William). A Manual of Spherical and Practical Astronomy. Medium 8vo, cloth. 2 vols.....	7.00
CHAUVENET'S LUNAR DISTANCES. By William Chauvenet. 8vo, cloth.....	2.00
DOVE. The Law of Storms Considered in Connection with the Ordinary Movements of the Atmosphere. By H. W. Dove. Translated, with the author's sanction and assistance, by Robert H. Scott, M. A. 8vo, cloth.....	4.50
DOWNES. Occultations of Planets and Stars by the Moon during the Year 1853. Computed by John Downes. Washington, 1853. Pamphlet.....	50
DUBOIS. De le Deviation du Compas a bord des Navires, et du moyen de l'obtenir a Paide du compas de deviations. Par E. Dubois. 1 vol. 8vo, paper. Paris, 1867.....	1.20
—— Cours de Navigation et d'Hydrographic. Par E. Dubois. 1 vol. 8vo, illustrated. Paris, 1859.....	6.00
—— Cours D'Astronomic. Troisieme edition. Corrigée et Considerablement Augmentée. Thick 8vo, paper. Paris, 1877.....	6.00
GAUSS. Theory of the Motion of the Heavenly Bodies moving about the Sun in Conic Sections. A translation of Gause's "Theoria Motus." With an appendix by Charles H. Davis. 1 vol. quarto. Boston, 1857.....	5.00

	PRICE
GLAISHER. Diurnal Range Tables. Newly arranged, containing corrections for temperature adapted to different hours of observation, for different ranges of daily temperature, with similar corrections for the barometer, etc. By James Glaisher, F. R. S. Fourth edition. London, 1867. 8vo, pamphlet.....	\$0.75
GRANT. History of Physical Astronomy from the Earliest Ages to the middle of the Nineteenth Century. By Robert Grant, F. R. A. S. London, 1849-52. 1 vol. 8vo, cloth.....	4.50
GUILLEMIN (Amedee). The Sun. From the French. By T. L. Phipson, Ph. D., with 58 illustrations. 12mo, fine cloth.....	1.50
— The Heavens. An Illustrated Hand-book of Popular Astronomy. By A. Guillemin. Edited by J. Norman Lockyer, F. R. A. S. Fourth edition, revised. New York, 1871. 8vo, cloth.....	4.50
— Wonders of the Moon. Translated from the French of Amedee Guillemin, by Miss M. G. Mead. Edited, with additions, by Maria Mitchell. 12mo, cloth, illustrated. New York, 1872.....	1.50
GUYOT. Tables, Meteorological and Physical. Prepared for the Smithsonian Institute by A. Guyot, Ph. LL.D. Third edition, revised and enlarged. Washington, 1859.....	3.00
HERSCHEL (Sir J. F. W.). Outlines of Astronomy. Eleventh edition, with plates and wood-cuts. 1 vol. 8vo, cloth.....	4.00
HUMBOLDT. A Physical Description of the Heavens. By Alexander Von Humboldt. Translated by Col. E. Sabine, R. A. 12mo, cloth. London, 1867.....	1.75
JOHNSTON. Atlas of Astronomy. By Alexander Keith Johnston. New and enlarged edition. With an Elementary Survey of the Heavens, by Robt. Grant. 1 vol. quarto, half morocco. London, 1869.....	12.50
LARDNER. Hand-book of Astronomy. By Dionysius Lardner, D. C. I. Third edition. Revised and edited by Edwin Dunkin, F. R. A. S. 1 vol. 12mo, illustrated. London, 1867.....	3.00
— Astronomy and Meteorology. By Dr. Lardner. 1 vol. royal 12mo, sheep. 37 plates and over 200 cuts.....	2.50
LA PLACE. Mécanique Céleste. Translated, with a Commentary, by Nathaniel Bowditch, LL.D. 4 vols. 4to. Boston, 1832-39. (Rare.).....	6.00
LOCKYER. Star-gazing Past and Present. By J. Norman Lockyer. 8vo.....	6.00
LOOMIS. A Treatise on Meteorology, with a collection of Meteorological Tables. By Elias Loomis, LL.D., Professor of Natural Philosophy and Astronomy in Yale College. Cuts. 8vo, sheep.....	1.75
NEWCOMB (Simon, LL.D.). Popular Astronomy, with 112 engravings and maps of the stars.....	4.00
PLYMPTON. The Star Finder; or, Planisphere with a Movable Horizon. Printed in colors on fine board, and in accordance with Proctor's Star Atlas. By Prof. G. W. Plympton, A. M. 4to. New York, 1878.....	1.00
— The Aneroid, and How to Use It. Compiled by Geo. W. Plympton. (Van Nostrand's Science Series, No. 35.) 16mo, bound. Illustrated. New York, 1878.....	50
— The same, in full morocco.....	1.00
PROCTOR (R. A.). Other Worlds than Ours. The plurality of worlds, studied under the light of recent scientific researches. Illustrated. 12mo, cloth...	2.50

	PRICE
PROCTOR (R. A.). Essays on Astronomy. A series of papers on planets and meteors, the sun, stars, etc., with 10 plates and 24 wood engravings. 1 vol. 8vo, cloth.....	\$4.50
—— The Moon; her Motions, Aspects, Scenery, and Physical Condition. Illustrated. Cloth.....	3.50
—— The Expanse of Heaven. A series of essays on the wonders of the firmament. 1 vol. 12mo, cloth.....	2.00
STEELE. Fourteen Weeks in Astronomy.....	1.00
THOMS. A New Treatise on the Practice of Navigation at Sea. By Capt. W. Thoms. 1 vol. 8vo, sheep.....	4.00
THOMSON. The Depths of the Sea: An Account of the General Results of the Dredging Cruises of H. M. S. "Porcupine" and "Lightning," during the summers of 1868, '69 and '70. By C. W. Thomson. 8vo, cloth, with numerous illustrations and maps. London, 1873.....	7.50
WATSON (James C.). Theoretical Astronomy. 632 pages royal 8vo, cloth....	10.00
WILLIAMSON. Practical Tables in Meteorology and Hypsometry, in Connection with the use of the Barometer. By Col. R. S. Williamson, U. S. A. 4to, flexible cloth.....	2.50
—— On the Use of the Barometer on Surveys, etc. With illustrative tables and engravings. 4to, cloth.....	15.00

### SOUND.

AIRY. On Sound and Atmospheric Vibrations, with the Mathematical Elements of Music. By Geo. B. Airy, M. A. 1 vol. 12mo, cloth. London, 1868.....	2.50
BARTLETT'S ACOUSTICS AND OPTICS.....	2.50
MAYER. Sound: A series of simple, entertaining, and inexpensive experiments in the Phenomena of Sound. For the use of students of every age. By A. M. Mayer. Cloth.....	1.00
SAELTZER. A Treatise on Acoustics in Connection with Ventilation. By Alexander Saeltzer. 12mo, cloth.....	1.00
STRUTT (John William). The Theory of Sound. Vol. 11, 8vo.....	4.50
TYNDALL (Prof. John). On Sound. A course of eight lectures, delivered at the Royal Institution of Great Britain. By John Tyndall, LL.D., F. R. S. Illustrated. 1 vol. 12mo. New edition. Cloth.....	2.00

### HEAT.

BOURNE (John). A Catechism of the Steam Engine. Illustrated and revised edition. 12mo, cloth.....	2.00
BOURNE. Hand-book of Steam Engines, constituting a key to the "Catechism of the Steam Engine." Illustrated with 67 wood-cuts. 12mo, cloth.....	2.00
—— A Treatise on the Steam Engine, in its various applications to Mines, Mills, Steam Navigation, Railways and Agriculture, with practical instruction for the manufacture and management of every species of engine in actual use. Illustrated with 37 plates and 546 wood-cuts. 1 vol. 4to. New edition. Cloth.....	15.00
BOX (Thomas). A Practical Treatise on Heat, as Applied to the Useful Arts. Revised and enlarged. Crown 8vo, cloth.....	5.00

	PRICE
FOURIER (Joseph). <i>An Analytical Theory of Heat.</i> By Joseph Fourier. Translated, with notes, by Alexander Freeman, M. A. 8vo.....	\$8.00
MAXWELL (J. Clerk). <i>Theory of Heat.</i> 1 vol. 12mo, cloth.....	1.50
MCCULLOCH. <i>A Treatise on the Mechanical Theory of Heat, and its Application to the Steam Engine, etc.</i> By R. S. McCulloch, C. E. 8vo, cloth..	3.50
PECLET (E.). <i>Traite de La Chaleur Considerle dans ses Applications.</i> Quartrieme edition. 3 vols. 8vo, paper. Paris, 1878.....	17.50
RANKINE. <i>The Steam Engine.</i> 12mo, cloth.....	5.00
THURSTON. <i>A History of the Growth of the Steam Engine.</i> By Robert H. Thurston, A. M., C. E. With 163 illustrations, including 15 portraits. 1 vol. 12mo., 490 pages, cloth.....	2.50
TROWBRIDGE. <i>Heat as a Source of Power, with Application of General Principles to the Construction of Steam Generators.</i> By W. P. Trowbridge. 8vo, cloth.....	3.50
TYNDALL (Prof. John). (International Scientific Series.) No. 1, <i>Forms of Water, in Clouds, Rain, Rivers, Ice and Glaciers.</i> 1 vol. 12mo, cloth.....	1.50
—— <i>Heat as a Mode of Motion.</i> 1 vol. 12mo. New edition. Cloth.....	2.00
—— <i>Radiant Heat</i> .....	5.00

### ELECTRICITY.

BAKEWELL. <i>A Manual of Electricity, Practical and Theoretical.</i> By T. C. Bakewell. Second edition, revised and enlarged. London, 1857.....	3.00
BECQUEREL. <i>Traite d'Electricite et de Magnetisme, suivi d'un expose de leurs rapports avec les actions Chimiques, et les Phenomenes, naturels.</i> Par M. Becquerel, 7 vols. 8vo, with atlas; paper.....	36.50
BELL. <i>Researches in Electric Telephony; being a lecture delivered before the Society of Telegraph Engineers, by Professor A. Graham Bell.</i> Profusely illustrated.....	00
CLARK & SABINE. <i>Electrical Tables and Formulæ for the use of Telegraph Inspectors and Operators.</i> Compiled by Latimer Clark and Robert Sabine. 12mo, cloth. London, 1871.....	5.00
DE LA RIVE. <i>A Treatise on Electricity, in Theory and Practice.</i> By A. De La Rive. 3 vols. 8vo, cloth.....	36.50
ELECTRICAL STANDARDS. <i>Reports of the Committee on Electrical Standards, appointed by the British Association. Revised by Prof. William Thomson, Prof. J. P. Joule, and Profs. Maxwell and Jenkins. With a Report to the Royal Society on Units of Electrical Resistance.</i> By Prof. F. Jenkin. Edited by Prof. Fleeming Jenkin, F. R. S. Plates. 8vo, cloth.....	3.75
FONTAINE (M.). <i>Electric Lighting.</i> Translated from the French of M. Fontaine. With wood engravings. 8vo, cloth.....	4.50
GUTHRIE. <i>Magnetism and Electricity,</i> by F. Guthrie, B. A., Ph. D., Royal School of Mines, London .....	1 50
GORDON. <i>Four Lectures on Static Induction.</i> By J. E. II. Gordon, B. A... ..	80
—— <i>Physical Treatise on Electricity and Magnetism.</i> 2 vols .....	7 00
HARRIS. <i>Rudimentary Magnetism. Being a concise Exposition of the General Principles of Magnetical Science and the Purposes to which it has been Applied.</i> By Sir W. Snow Harris. Second edition, revised and enlarged by H. M. Noad. 12mc, cloth. Illustrated. London, 1872. ....	1 80

	PRICE
HASKINS. The Galvanometer and its Uses. By C. H. Haskins. Pocket form, illustrated, morocco tucks.....	\$1 50
IVES. Electricity as a Medicine and its Mode of Application. By John Ives, M. D.....	1 00
JENKIN (Fleming, F. R. S., S. L.). Electricity and Magnetism. 12mo, cloth	1 50
JOURNAL OF THE SOCIETY OF THE TELEGRAPH ENGINEERS. Published in parts. 8vo, paper. Each.....	2 00
KEMPE (H. R.). A Hand-book of Electrical Testing Association of the Society of Telegraph Engineers. Foolscap. 8vo, cloth.....	2 00
KOHLRAUSCH (Dr. J.). An Introduction to Physical Measurements. With Appendices on Absolute Electrical Measurement, etc. 1 vol. 8vo.....	2 50
MAXWELL. A Treatise on Electricity and Magnetism. By John Clerk Maxwell, A. M. 2 vols. 8vo. Oxford, 1873 ..	10 00
NOAD. The Student's Text-Book of Electricity. A Condensed Resume of the History, Theory, and Applications of Electrical Science. By H. M. Noad. 1 vol. post 8vo, cloth. Illustrated. London, 1866.....	4 00
—— A Manual of Electricity, including Galvanism, Magnetism, Diamagnetism, Electro-Dynamics, Magnets, Electricity, and the Electric Telegraph. Fourth edition, entirely re-written. By H. M. Noad. 8vo, cloth .....	10 00
NIAUDET. Elementary Treatise on Electric Batteries. Alfred Niaudet, 1880	2 50
PLIM. Plain Directions for the Construction and Erection of Lightning-rods. By John Plim, C. E. 12mo, cloth .....	50
POPE (Frank L.). Modern Practice of the Electric Telegraph. By Frank L. Pope. Third edition, with numerous wood engravings. 8vo, cloth.....	2 00
PRESCOTT (G. B.). Electricity and the Electric Telegraph. 1 vol. 8vo.....	5 00
—— The Speaking Telephone, Electric Light and other recent Electrical Inventions. New edition. 8vo, cloth.....	4 00
SAWYER. Electric Lighting by Incandescence, and its Application to Interior Illuminations. By Wm. Edward Sawyer. 1 vol. 8vo, cloth.....	2 50
SPANG. A Practical Treatise on Lightning Protection. By Henry W. Spang. With illustrations. Crown 8vo, cloth.....	1 50
SPRAGUE. Electricity; its Theory, Sources and Applications. By John T. Sprague, member of the Society of Telegraph Engineers. With 91 woodcuts and 30 valuable tables. Crown 8vo, cloth .....	3 00
THOMSON. Reprint of Papers on Electrostatics and Magnetism. By Sir Wm. Thomson, D. C. L. 8vo, cloth. London, 1872.....	7 50
TYNDALL (Prof. John). Lessons in Electricity, at the Royal Institution, 1875-76. 1 vol. 12mo.....	1 00
—— Notes of a Course of Nine Lectures on Electrical Phenomena and Theories, delivered at the Royal Institution of Great Britain. By John Tyndall, LL. D. 12mo, cloth. London, 1870 .....	75
—— Researches on Diamagnetism and Magnetic Crystalline Action, including the Question of Diamagnetic Polarity. By John Tyndall. 1 vol. 8vo, cloth, with numerous illustrations. London, 1870 .....	7 00



## LIGHT.

	PRICE
ABNEY (W. de W., F. R. S.). A Treatise on Photography.....	1.50
AIRY, on the Undulatory Theory of Optics. Designed for use of Students in the University. By G. B. Airy, M. D. (Out of print.)	
—— Geometrical Optics, adapted to the use of the Higher Classes in Schools. By Osmond Airy, B. A. 1 vol. 12mo, cloth. London, 1870.....	90
BACON. The Theory of Coloring. Being an Analysis of the Principles of Contrast and Harmony. By J. Bacon. London, 1866. 1 vol. 12mo, cloth	1.25
BECQUEREL. La Lumiere ses Causes et ses Effets. Par M. Edmund Becquerel. 2 vols, 8vo. Paris, 1868.....	6.40
BEZOLD (Dr. W. Von). The Theory of Color, in its Relation to Art and Art Industry. By Dr. W. Von Bezold, Professor of Physics at the Royal Polytechnical School of Munich. Translated from the German by S. R. Koehler. With an introduction and notes, by Edward C. Pickering Thayer, Professor of Physics at the Massachusetts Institute of Technology. Authorized American edition, revised and enlarged, and illustrated. 1 vol., large 12mo.....	5.00
BREWSTER. A Treatise on Optics. By Sir David Brewster. 1 vol. 12mo, cloth.....	1.75
—— The Stereoscope; its History, Theory and Construction, with its Application to Useful Arts and to Education. 1 vol. 12mo, cloth. London, 1870.....	2.25
—— The Kaleidoscope; its History, Theory and Construction, etc. 1 vol. 12mo, cloth. London, 1869.....	2.25
CAPRON (J. Rand). Spectrum Analysis. One hundred and thirty-six Photographs of Metallic, Gaseous and other Spectra, printed by the permanent Autotype process. With introduction, description of plates and index, and with an extra plate of the Solar Spectrum (showing bright lines), compared with the Air Spectrum. By J. Rand Capron, F. R. A. S. 8vo, cloth.....	12.00
CHEVREUL. The Principles of Harmony and Contrast of Colors, and their Application to the Arts. By M. E. Chevreul. Third edition, illustrated with colored plates. London, 1860.....	3.00
DOLBEAR (A. E.). The Art of Projecting. A Manual of Experimentation in Physics, Chemistry and Natural History, with the Port Lumiere and Magic Lantern. By Prof. A. E. Dolbear. Crown 8vo, cloth.....	1.50
HUNT. Researches in Light in its Chemical Relations. Embracing a consideration of all the Photographic Processes. By Robert Hunt, F. R. S. Second edition. London, 1854.....	4.00
KULME (Dr. W.). On the Photo-Chemistry of the Retina, and on the Visual Purple. Translated from the German. Edited, with notes, by Michael Foster, M. D., F. R. S. 8vo.....	1.50
LLOYD. Elementary Treatise on the Wave Theory of Light. By Humphrey Lloyd, D. C. L. Third edition. 8vo. London, 1875.....	4.20
LOCKYER (J. Norman, F. R. S.). Studies in Spectrum Analysis. Illustrated	2.50
—— Contributions to Solar Physics. Popular account of inquiries into the Physical Constitution of the Sun, with special reference to recent Spectroscopic researches, etc. With illustrations. By J. Norman Lockyer, F. R. S. 8vo.....	7.50

	PRICE
LOMMEL (Dr. Eugene). The Nature of Light. With a general account of Physical Optics. With 188 illustrations and a plate of Spectre in Chromolithography. 1 vol. 12mo, cloth.....	2.00
MAYER AND BARNARDS. Light; a Series of Simple, Entertaining and Inexpensive Experiments in the Phenomena of Light. Cloth.....	1.00
MONCKHOVEN. Photographic Optics, including the Description of Lenses and Enlarging Apparatus. By D. Monckhoven. 1 vol. 12mo. Illustrated. London, 1867.....	3.00
NUGENT. Treatise on Optics. By E. Nugent. With 103 illustrations. 12mo, cloth.....	1.50
PEREIRA. Lectures on Polarized Light. By J. Pereira. 1 vol. 12mo, cloth. London, 1854.....	\$1.25
PHIPSON'S PHOSPHORESCENCE. 12mo, cloth.....	1.75
POTTER. An Elementary Treatise on Optics. By Richard Potter, A. M. 2 vols 8vo, cloth.....	8.00
ROSCOE (Henry E.). Spectrum Analysis. Six Lectures, delivered in 1868, before the Society of Apothecaries, in London. With appendices, colored plates and illustrations. 1 vol. 8vo, cloth, extra.....	9.00
SCHELLEN (H.). Spectrum Analysis in its Application to Terrestrial Substances, and the Physical Constitution of the Heavenly Bodies. With numerous wood-cuts, colored plates and portraits; also Augstrom's and Kirchoff's maps. 1 vol. 8vo, 455 pages, cloth.....	6.00
TYNDALL (Prof. John). Light and Electricity. Notes of two courses of Lectures before the Royal Institution of Great Britain. 12mo, cloth.....	1.25
—— Six Lectures on Light, delivered in America, in 1872-73. With Appendix and numerous illustrations. Cloth.....	1.50
VOGEL (Prof.). Chemistry of Light and Photography. (International Scientific Series.) 1 vol. 12mo, cloth.....	2.00

### CHEMISTRY.

APJOHN. Manual of Metalloids. By James Apjohn. 12mo, cloth. London, 1864.....	3.00
ARMSTRONG'S ORGANIC CHEMISTRY.....	1.50
ATTFIELD. Chemistry; General, Medical and Pharmaceutical. By J. Attfield. 12mo, cloth. Philadelphia, 1871.....	2.50
AVERY. Elements of Chemistry. By Elroy M. Avery.....	1.10
BARKER. A Text-Book of Elementary Chemistry, Theoretical and Inorganic, By G. T. Barker.....	1.75
BARRESWIL ET DAVAUNE. Chimie Photographique, Contenant les Elements de Chimie Expliques, par des Exemples Empruntes a la Photographie. Third edition. 1 vol. 8vo, paper.....	3.50
BLOXHAM. Chemistry, Inorganic and Organic. With experiments, and a comparison of Equivalents and Molecular Formulæ. By C. L. Bloxham. 8vo, cloth. Third Edition. London, 1876.....	4.00
—— Laboratory Teaching; or, Progressive Exercises in Practical Chemistry. By C. L. Bloxham. 1 vol. 12mo, cloth. London, 1869.....	1.75
BOLLEY AND PAUL. Manual of Technical Analysis. Illustrated. 12mo....	2.50

	PRICE
BOOTH AND MORFIT. Encyclopedia of Chemistry, Theoretical and Practical. By J. C. Booth and C. Morfit. Seventh edition, with numerous illustrations. 8vo.....	5.00
BOWDITCH (W. R., M. A.). Gas. Technical Valuation, Purification, and Use of Coal Gas. With wood engravings. 8vo, cloth.....	4.50
CALDWELL. Agricultural, Qualitative and Quantitative Chemical Analysis. After Wolf Frensius, Krocker and others. Edited by G. E. Caldwell. 1 vol. 12mo, cloth.....	2.00
COOKE (Prof. J. P., Jr.). New Chemistry. (International Scientific Series)..	2.00
COOLEY'S ELEMENTARY CHEMISTRY.....	72
——— Advanced ".....	80
ELDERHORST. Blowpipe Analysis and Determinative Mineralogy. By W. Elderhorst.....	\$2.50
ELIOT AND STORER. A Compendium Manual of Qualitative Chemical Analysis	1.50
FARADAY. Experimental Researches in Chemistry and Physics. By Michael Faraday, F. R. S. London, 1867. 8vo, cloth.....	7.50
——— A Course of Six Lectures on the Various Forces of Matter. By Michael Faraday, F. R. S. Illustrated. 12mo.....	2.00
——— The Chemistry of a Candle. By Michael Faraday, F. R. S. Illustrated, 12mo.....	2.00
FOWNES. Chemistry, including Agricultural Chemistry. By Prof. George Fownes. (Weale Series.).....	60
——— A Manual of Elementary Chemistry. By George Fownes, 12mo, cloth. Philadelphia, 1869.....	2.75
FRANKLAND. Lecture Notes for Chemical Students. By E. Frankland. Vol. 1, Inorganic Chemistry. Second edition. London, 1870.....	2.00
FRESENIUS. Manual of Qualitative Chemical Analysis. By C. R. Fresenius. 8vo, cloth. Ninth English edition. London, 1876.....	5 00
——— A Manual of Quantitative Chemical Analysis. By C. R. Fresenius. Seventh English edition. 8vo, cloth. London, 1876.....	6.00
FREY (Heinrich). The Histology and Histo-Chemistry of Man. A Treatise on the Elements of Composition and Structure of the Human Body. Illustrated with 608 engravings on wood. 1 vol. 8vo, cloth.....	5.00
Sheep.....	6.00
GROOME. Notes on Agricultural Chemistry. By William Groome. 8vo, flex. cloth. London, 1870.....	60
HOFFMAN (Frederick). Manual of Chemical Analysis, as Applied to the Examination of Medicinal Chemicals, etc., etc. For the use of Pharmacutists, Physicians, Druggists, and Manufacturing Chemists, and Students. Cloth.....	3.00
LEWIS. Chemical Labels, According to the Latest System of Nomenclature...	50
LIEBIG & KOPP. Annual Reports—Chemistry and Allied Science. 4 vols. 8vo.....	12.00
MILLER. Elements of Chemistry, Theoretical and Practical. By W. A. Miller. 3 vols. 8vo. Fifth edition. London, 1868-69.....	25.00
——— Introduction to the Study of Inorganic Chemistry. By W. A. Miller. 12mo, cloth. London, 1871.....	1.50
MORTON AND LEEDS. The Student's Practical Chemistry. A Text-Book on Chemical Physics, and Organic and Inorganic Chemistry.....	2.00

	PRICE
<b>NOAD.</b> Chemical Analysis, Quantitative and Qualitative. By Henry M. Noad. 8vo, cloth.....	6.00
<b>ODLING.</b> A Manual of Chemistry. By William Odling. Part 1, 8vo.....	3.60
<b>PAYEN.</b> Industrial Chemistry. A Manual for Manufacturers, and for use in Colleges and Technical Schools. Being a translation of the German edition of Payen's <i>Precis de Chemie Industrielle</i> . Edited throughout and supplemented with Chapters on the Chemistry of Metals, by B. H. Paul, Ph. D. 8vo, calf. London, 1878.....	10 00
<b>PLATTNER.</b> Manual of Qualitative and Quantitative Analysis of the Blowpipe. Translated from the latest German edition, by Henry B. Cornwall, A. M. With 87 wood-cuts and 1 plate. 8vo, cloth.....	5.00
<b>PLYMPTON.</b> The Blowpipe. A Guide to its Use in the Determination of Salts and Minerals. Compiled from various sources, by Prof. George W. Plympton, A. M. 12mo, flexible cloth. New York, 1874.....	\$1.50
<b>PYNCHON.</b> Chemical Physics. By Thos. Ruggles Pynchon. Crown 8vo, cloth	3.00
<b>RAMMELSBURG.</b> Quantitative Chemical Analysis on Minerals and Furnace Products. By C. F. Rammelsburg. 8vo, cloth.....	2.25
<b>REGNAULT.</b> Elements of Chemistry, for the use of Academies, Colleges, etc. By M. V. Regnault. 2 vols. 8vo.....	7.50
<b>REIMANN.</b> On Aniline and its Derivatives. A Treatise upon the Manufacture of Aniline and Aniline Colors. By M. Reimann. Revised and edited by W. N. Crookes. 1 vol. 8vo., cloth. New York, 1868.....	2.50
<b>RICHARD (William).</b> A Practical Treatise on the Manufacture and Distribution of Coal Gas, History of Gas Lighting, Chemistry of Gas Manufacture, Photometer, etc., etc. Demi 4to, numerous wood engravings, and large plates. Cloth.....	12.00
<b>ROSCOE.</b> Lessons in Elementary Chemistry, Inorganic and Organic. By Henry Roscoe, B. A. New edition; revised by the author. London, 1871	1.10
<b>ROSCOE (H. E.) AND SCHORLEMMER (C.).</b> Treatise on Chemistry. 8vo. Illustrated. Volume 1 ready.. Cloth.....	5.00
<b>ROSE.</b> A Practical Treatise on Chemical Analysis, Qualitative and Quantitative. By H. Rose. 3 vols. 8vo. London, 1849.....	12.50
<b>SCHERER AND BLANFORD.</b> Blowpipe Analysis. 1 vol. 12mo, cloth.....	2.00
<b>SCHORLEMMER (C.).</b> A Manual of the Chemistry of the Carbon Compound, or Organic Chemistry. 8vo, calf. London, 1874.....	5.00
<b>SCOTT.</b> A Hand-book of Volumetrical Analysis. By Robert H. Scott, M. A. 1 vol. 12mo, cloth.....	2.25
<b>SHARPLES.</b> Chemical Tables. By Stephen P. Sharples. 1 vol. 12mo, cloth.	2.25
<b>SILLIMAN.</b> First Principles of Chemistry. By Benjamin Silliman. 12mo....	2.00
<b>SMITH (Henry Arthur).</b> The Chemistry of the Sulphuric Acid Manufacture. 8vo, cloth.....	2.00
<b>STORER.</b> A Dictionary of Chemical Solubilities. By F. H. Storer. 8vo, 3 parts, paper.....	6.00
Cloth.....	7.50
Half Russia.....	9.00
——— <b>Cyclopedia of Quantitative Chemical Analyses.</b> By Frank H. Storer. To be completed in six parts. Parts 1 and 2 published. Price, per part..	1.05
<b>THORPE'S QUALITATIVE CHEMICAL ANALYSIS</b> .....	1.50
<b>TILDEN'S INTRODUCTION TO CHEMICAL PHILOSOPHY</b> .....	1.50

PRICE

WAGNER (Rudolf). Hand-book of Chemical Technology. Translated by William Crookes, F. R. S. With 336 illustrations and 761 pages. 1 vol. 8vo, cloth.....	5.00
YOUMANS (E. L.). Class-Book of Chemistry. New edition. 12mo.....	1.75

**MISCELLANEOUS.**

BECKER (Bernard H.). Scientific London. 1 vol. 12mo, cloth.....	1.75
CUTTER. New Outline Zoological Charts, or Human and Comparative Anatomical Plates, colored and mounted on rollers. Whole set (3 feet by 2), 9 numbers.....	15.00
Half set, 5 numbers.....	9.00
HALF HOURS WITH MODERN SCIENTISTS. Lectures and Essays, by Profs. Huxley, Barker, Stirling, Cope and Tyndall. With general introduction, by Noah Porter, LL.D. 2 vols. Price reduced to \$1.25 per vol.....	\$2.50
HELMHOLTZ (H.), Professor of Physics in the University of Berlin. Popular Lectures on Scientific Subjects. Translated by E. Atkinson, Ph. D., F. C. S.. With an introduction by Prof. Tyndall. Cloth.....	2.00
HERSCHEL. Memoir and Correspondence of Caroline Herschell (Sister of Sir William). Illustrated with portraits. Cloth.....	1.75
HUMBOLDT'S (ALEXANDER VON) WORKS. Viz.: Cosmos; a Shetch of a Physical Description of the Universe, 5 vols.; Narrative of Travels in the Equinoctial Regions of America, 3 vols.; Views of Nature, or Contemplations on the Sublime Phenomena of Creation. With scientific illustrations. 1 vol. Complete in 9 vols. Half calf, extra.....	27.00
JEVONS. A Treatise on Logic and Scientific Method. By W. Stanley Jevons, LL.D., M. A. Second edition, revised. 12mo.....	3.50
PEPPER. Cyclopædic Science Simplified. By J. H. Pepper. 1 vol. 8vo, cloth, gilt. London, 1869.....	3.75
— The Boys' Play-Book of Science, including the various manipulations and arrangements of chemical and philosophical apparatus required for the successful performance of scientific experiments. By John Henry Pepper. New edition, illustrated with 470 illustrations. 1 vol. 12mo, cloth. London, 1870.....	2.00
PICKERING. Elements of Physical Manipulation, including Meteorology, Astronomy and Lantern Projections, etc., etc. 2 vols. 8vo. Vol. 1.....	3.00
Vol. 2.....	4.00
PROCTOR. Light Science for Leisure Hours. A Series of Familiar Essays on Scientific Subjects. Cloth.....	1.75
SCIENCE LECTURES AT SOUTH KENSINGTON. Vol. 1., 12mo.....	1.75
CONTENTS: Photography, Light and Colors, Fluorescence, Kinematics of Machinery, Steam Engine, Radiation, Microscopes, Electrometers, Apparatus Relating to Vegetable Physiology, Electrical Measurements.	
SPON (E.). Workshop Receipts. By E. Spon.....	2.00
STEWART (Prof. Balfour, LL.D., F. R. S.). The Conservation of Energy. 1 vol. 12mo. (International Scientific Series.).....	1.50
TAIT. Lectures on some Recent Advances in Physical Science, with a Special Lecture on Force. By P. G. Tait, M. A. Second edition, revised. 12mo.....	2.50

	PRICE
<b>TODHUNTER.</b> Theory of Probabilities. A History of the Mathematical Theory of Probability, from the time of Pascal to that of Laplace. By J. Todhunter. 8vo, cloth.....	6 00
<b>TYNDALL</b> (Prof. John). Fragments of Science for Unscientific People. Cloth	2.00
—— Hours of Exercise in the Alps. Illustrated. 12mo, cloth.....	2.00
—— Faraday as a Discoverer. A Memoir. 1 vol. 12mo, cloth.....	1.00
—— Essays on the Use and Limit of the Imagination in Science. By John Tyndall, F. R. S. 8vo, cloth. London, 1870.....	1.40
<b>WHEELER'S NATURAL HISTORY CHARTS.</b> Per set of five numbers, with over 700 beautifully-colored illustrations, with Text-Book, or Key, of 100 pages.....	30.00
Price of each Chart, mounted, four feet by three.....	7.00
<b>WHEWELL'S HISTORY OF THE INDUCTIVE SCIENCES,</b> from the Earliest to the Present Time. Third London edition. 2 large vols., 8vo, cloth.....	\$5.00
Half calf, extra.....	10.00
<b>WILSON'S SCHOOL AND FAMILY CHARTS.</b>	
Set of 22 Charts, mounted.....	12.60
“ “ unmounted.....	9.28
Chart No. XIII, familiar colors, with a duplicate set of hand-color cards..	1.05
“ XIV, chromatic scale of colors.....	88
The two, mounted.....	2.00
<b>WRIGHT</b> (Charles R. Alder). Metals, and their Chief Industrial Applications. 16mo.....	1 25
<b>YOUMANS</b> (E. L.). The Culture Demanded by Modern Life. A Series of Addresses and Arguments on the Claims of Scientific Education. Edited, with an Introduction on Mental Discipline, by Edward L. Youmans, M. D. 1 vol. 12mo, cloth.....	2.00
—— Correlation and Conservation of Forces. A Series of Expositions by Prof. Grove, Prof. Helmholtz, Dr. Moyer, Dr. Faraday, Prof. Liebig and Dr. Carpenter. Edited, with an introduction, and brief biographical notices of the chief promoters of new views, by E. L. Youmans. 1 vol. 12mo, cloth.....	2.00

### WORKS OF REFERENCE.

<b>APPLETON'S AMERICAN CYCLOPEDIA.</b> A Popular Dictionary of General Knowledge. Edited by George Ripley and Charles A. Dana. Complete in 16 vols., of over 800 pages each. Fully illustrated, with several thousand wood engravings and numerous colored lithographic maps. Subscription, cloth.....	5.00
Sheep.....	6.00
Half morocco.....	7.00
Full morocco.....	10.00
<b>APPLETON'S DICTIONARY OF MECHANICS, MACHINES, ENGINE-WORK AND ENGINEERING.</b> Containing over 4,000 illustrations and nearly 2,000 pages. Revised and corrected. Complete in 2 vols., large 8vo. Half morocco.....	18.00
<b>BLACK.</b> General Atlas of the World. A new and improved edition, with extra Maps. A. & C. Black, Edinburgh, 1875. 4to, half morocco.....	22.50

	PRICE
<b>CHAMBERS' ENCYCLOPEDIA.</b> In 10 8vo. volumes, with 4,000 engravings and 40 maps. Price per set, cloth.....	25.00
Library sheep.....	30.00
Half Russia .....	50.00
<b>COLTON'S GENERAL ATLAS.</b> Containing 190 Maps and Plans. 1 vol. folio, half morocco.....	20.00
<b>DICTIONARY OF TERMS IN SCIENCE AND ART.</b> (Weale's Series.) London, 1874. Cloth .....	2.50
<b>DICTIONARY OF TECHNICAL TERMS</b> used in Arts and Manufactures. Part I.—German-English-French. Part II.—English-German-French. Part III.—French-German-English. 3 vols. 12mo. New York, 1872. Paper .....	3.75
Half morocco.....	7.50
<b>DODD.</b> Dictionary of Manufactures, Mining, Machinery and the Industrial Arts. By George Dodd. 12mo, cloth. New York, 1869.....	\$1.50
<b>DUCKETT.</b> Technological Dictionary—German, English, French. By Capt. George Duckett. 8vo. London, 1848.....	6.00
<b>ENCYCLOPEDIA BRITANNICA.</b> A new edition, with upwards of 500 engravings on steel and many thousands on wood. 22 vols. 4to, cloth. New edition. 7 vols. ready. Per vol., cloth.....	8.00
Half Russia.....	10.00
<b>HUTTON.</b> A Course of Mathematics, composed for the use of the Royal Military Academy. By Charles Hutton, and entirely remodelled by W. Rutherford. 1 vol. 8vo. London, 1860.....	6.00
— Mathematical Tables, containing Common, Hyperbolic, and Logistic Logarithms, etc. 1 vol. 8vo. By Charles Hutton.....	5.00
<b>ICONOGRAPHIC CYCLOPEDIA.</b> 6 vols., full morocco.....	100.00
<b>JOHNSON'S NEW UNIVERSAL CYCLOPEDIA.</b> A Scientific and Popular Treasury of Useful Knowledge. Illustrated with maps, etc. Frederick A. P. Barnard, S. T. D., LL.D., L. H. D., M. N. A. S.; Arnold Guyot, Ph. D., LL.D., M. N. A. S., Editors in Chief. 4 vols.....	50.00
<b>SCHRÖN.</b> Seven-Figure Logarithms of Numbers from 1 to 108,000, and of Sines, Co-Sines, Tangents, Co-Tangents, to every 10 Seconds of the Quadrant, with a Table of Proportional Parts. By Dr. Ludwig Schrön. Fifth edition, with a Description of the Tables, added by Prof. De Morgan. 1 vol. 8vo, half morocco.....	3.50
<b>SHORTREDE.</b> Logarithmic Tables. containing Logarithms to Numbers from 1 to 120,000; Numbers to Logarithms from 0 to 100,000; to Seven Places of Decimals. With Logarithmic Tables to Seven Places of Decimals. By R. Shortrede. 2 vols. 8vo, cloth.....	21.00
<b>URE (Dr.)</b> Dictionary of Arts, Manufactures and Mines. New edition, greatly enlarged. 8vo, half Russia. London, 1878.....	36.00
<b>WATTS.</b> Dictionary of Chemistry and the Allied Branches of Other Sciences. By Henry Watts, B. A. Assisted by eminent scientific and practical chemists. 8 vols. 8vo, cloth. London, 1866-79.....	8.50
<b>WORCESTER.</b> Standard Dictionary of the English Language. Royal quarto. Sheep, mottled edges .....	10.00
Half Russia.....	12.00

WE PUBLISH  
PRICED AND ILLUSTRATED  
❖ **CATALOGUES** ❖

As follows, any or all of which will be Mailed on Application.

- PART 1.—Mathematical Instruments**, 205 pages. Contains list and prices of Drawing Instruments, Drawing Materials, Pocket Compasses, Surveying Compasses, Engineers' Transits and Levels, Surveying Chains, Tape Measures, Pocket Rules, and Books relating to Drawing, Engineering, and Mechanics.
- PART 2.—Optical Instruments**, 192 pages. Contains list and prices of Spectacles, Eye-glasses, Lenses, Laryngoscopes, Polarizing Apparatus, Graphoscopes, Stereoscopes, Reading-glasses, Simple Microscopes, Compound Microscopes, Microscopic Objectives and Accessories, Mounting Materials, Microscopic Objects (including Histological and Pathological Specimens), Microscopic Books, etc.
- PART 2.—(SUPPLEMENT.)—Opera Glasses, Tourist Glasses, Race Glasses, Field Glasses, Marine Glasses, Spy Glasses, and Telescopes.**
- PART 2.—(SUPPLEMENT.)—Second-Hand Microscopes and Accessories.** 8 pages.
- PART 2.—(SUPPLEMENT.)—Astronomical Telescopes and Appliances.** 32 pages.
- PART 3.—Magic Lanterns and Slides**, 150 pages. Contains list and prices of Magic Lanterns, for Toys and for Public and Private Exhibitions, Sciopticons, Stereopticons, Scientific Lanterns, and accessory apparatus to be used with them; Magic Lantern Slides, both colored and uncolored.
- PART 4.—Physical Instruments**, 220 pages. Contains list and prices of Instruments to illustrate lectures in every department of Physics and Chemical Science, Air Pumps, Electric Machines, Galvanic Batteries, Globes, Spectroscopes, Auzoux's Anatomical Models, and Books relating to Scientific Subjects.
- PART 4.—(SUPPLEMENT.)—Chemical Glassware, Chemical Apparatus, Chemicals, Analytical Apparatus, and Fine Balances.** 50 pages.
- PART 4.—(SUPPLEMENT.)—Dynamo Machines and Accessories**, 16 pages.
- PART 4.—(SUPPLEMENT.)—Catalogue of Electrical Instruments, in two parts.**
- PART 5.—Meteorological Instruments.** Contains list and prices of Thermometers, Mercurial and Aneroid Barometers, Hygrometers, Anemometers, Rain Gauges, Wind Gauges, Tide Gauges, Current Meters, Pyrometers, Hydrometers, Salinometers, Vacuumeters, Water Gauges, Miners' Safety Lamps, Pressure and Vacuum Gauges, and all instruments for measuring Steam, Air, Gas, or Water.
- PART 6.—Photographic Apparatus**, including Cameras, Lenses, Dry-plates, Sensitized paper, and other materials. 48 pages.

**JAMES W. QUEEN & Co.,**

**Mathematical, Optical, and Philosophical Instrument Makers,**

924 CHESTNUT STREET, PHILADELPHIA.



# JAMES W. QUEEN & CO.,

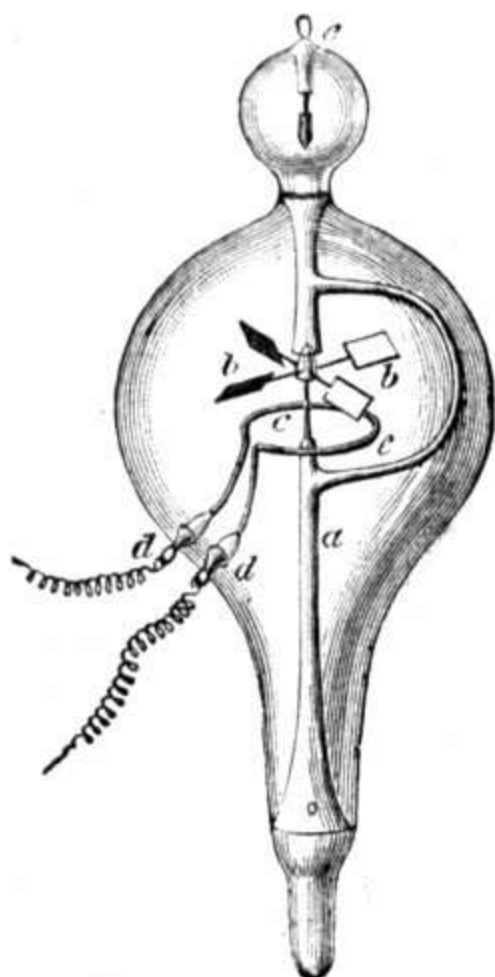

CROOKES' TUBE, No. 13.

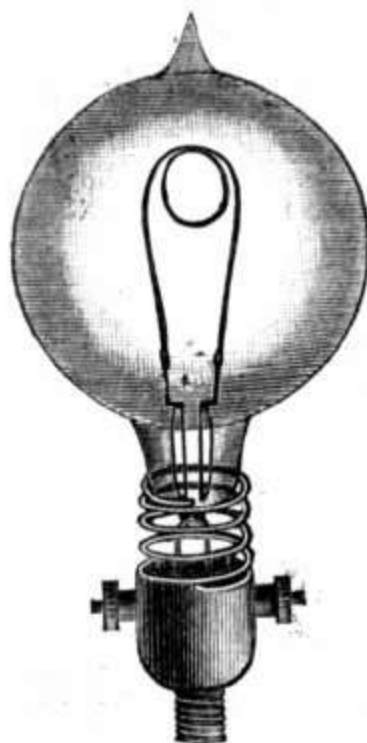

INCANDESCENT ELECTRIC LAMP.

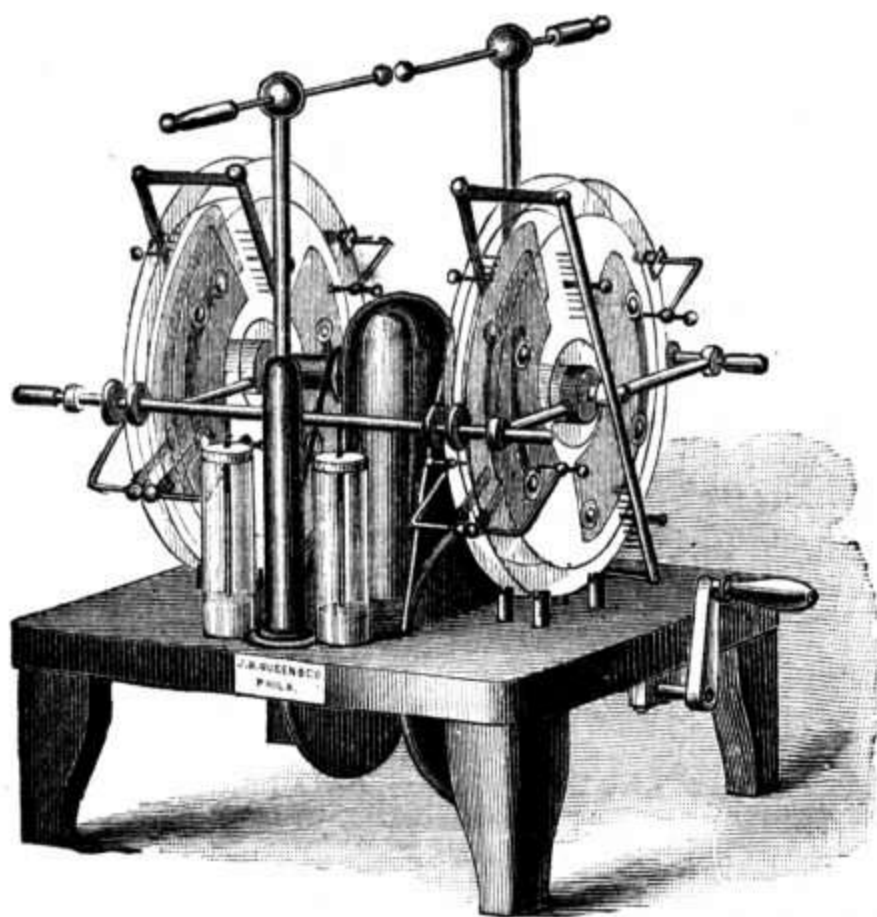

QUEEN'S 4-PLATE TÖPLER-HOLTZ ELECTRICAL MACHINE.

924 CHESTNUT STREET,  
PHILADELPHIA.

S 864 ①