

101 87  
PRICED AND ILLUSTRATED

CATALOGUE

OF

PHYSICAL INSTRUMENTS

AND

SCHOOL APPARATUS,

MADE, IMPORTED, AND SOLD, WHOLESALE AND RETAIL, BY

JAMES W. QUEEN & CO.,

No. 601 BROADWAY, NEW YORK,

AND  
No. 924 CHESTNUT STREET, PHILADELPHIA.



52503

Entered according to Act of Congress, in the year 1874, by

JAMES W. QUEEN & CO..

In the Office of the Librarian of Congress, at Washington.

JOHN F. TROW & SON,  
PRINTERS AND BOOKBINDERS,  
205-213 *East 12th St.*,  
NEW YORK.

## NOTICE.

---

HAVING the largest and best assorted Stock of Mathematical, Optical and Philosophical Instruments, both of foreign and domestic manufacture, in the United States, we are enabled to offer unequalled facilities and inducements to intending purchasers.

In ordering Instruments and materials from this Catalogue, it is merely necessary to state the edition and the numbers of the articles. *All former Editions are superseded by this.*

## TERMS CASH.

The prices throughout the Catalogue will be strictly adhered to.

When no satisfactory Philadelphia or New York reference is given by the party ordering the goods, the money should accompany the order; but where it does not (either from want of confidence or other cause), the goods will be forwarded by express, with bill, C. O. D. (collect on delivery), *provided a remittance equal to one-third the total amount of the order is sent with it.*

*No order for a less amount than Twenty-Five Dollars will be sent C. O. D.*

The Express Company's charge for collecting and returning the money on C. O. D. bills, must be paid by the party ordering the goods.

The safest and most economical method of remitting money is by Bank Draft or Post-Office Order, made payable to us. Where neither of these can be procured, United States or National Bank Notes, or Postage Stamps, can be sent by express with safety, the sender prepaying the express charges.

Goods ordered to be sent by mail must be prepaid, and the return postage included in the remittance.

All packing boxes will be charged for, and all goods will be packed with the utmost care; but no responsibility will be assumed by us, for breakage or other damage, after a package leaves our premises, except upon special contract.

SAMUEL L. FOX,  
JESSE S. CHEYNEY,  
WILLIAM H. WALMSLEY, } Trading as  
JAMES W. QUEEN & CO.

NEW YORK, June 11th, 1874.

F - 5/8/80

## PREFACE TO TWENTY-FIRST EDITION.

---

THE great changes in the mode of illustrating various laws of physical science, as well as the discovery of many new laws to be illustrated, have demanded of us a more thorough classification and complete list of such instruments as are now available for these purposes.

We have endeavored, in the present manual, to present such a list, arranged, so far as practicable, in a strictly scientific order. In all cases where it seemed necessary, we have illustrated the *style* of our instruments by a wood-cut.

The growing importance of Spectrum Analysis, and, also, the method of illustrating physical laws by optical projection, warrant us in calling particular attention to the chapter on Optics. The instrument for projection there described is the same, essentially, as that mentioned in the *American Journal* for August, 1868, and has been thoroughly tested in every way.

We have appended to our list of Physical Instruments, besides a list of Chemical Apparatus, a list of the celebrated Auzoux's Anatomical Models, which are gradually and deservedly making their way into many of our best institutions of learning; and also of the less known but still excellent ones of Böck and Steger.

While it will be our aim to keep as nearly a complete stock of the instruments described in this manual as possible, we shall devote particular attention to keeping always a full line of those goods which are in constant and general use in the class and lecture room. Orders for instruments for special uses, or for those not in stock, will be promptly attended to.

We trust that this effort to place before our friends and patrons a more complete list of strictly first-class physical apparatus will meet their approval.

JAMES W. QUEEN & Co.

JUNE 11th, 1874.



# CATALOGUE

OF

## PHYSICAL INSTRUMENTS

---

### CHAPTER I.

#### INSTRUMENTS ILLUSTRATING THE ESSENTIAL RELATIONS OF MATTER AND FORCE.

##### SECTION I.—ON MEASUREMENT.

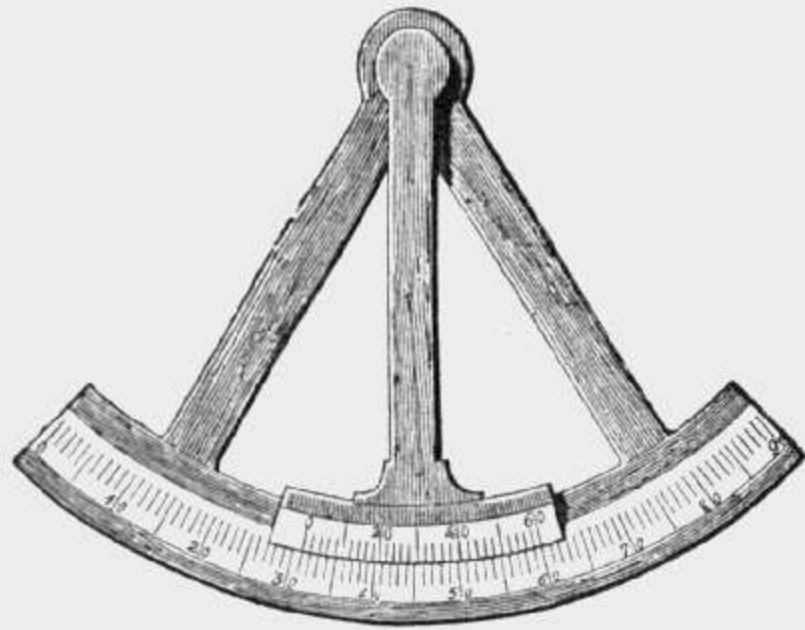

4004.

No.		PRICE
4000.	<b>Metre and Yard.</b> Square rod of wood with metal tips, having the metre and the yard with their subdivisions on adjacent sides.....	\$5 00
4001.	<b>Steel Tape.</b> Six feet in length, divided on one side into feet and inches, on the other into millimetres.....	3 00
4002.	<b>Card-Board Rule.</b> Half a metre in length, accurately divided to millimetres on one edge, and inches and subdivisions on the other.....	1 00
4003.	<b>Model of Vernier.</b> Straight form, of white-wood, one metre in length.....	10 00
4004.	<b>Model of Vernier.</b> Of white-wood, arc of circle, one metre in diameter.....	20 00
4005.	<b>Spherometer.</b> To measure exceedingly small thicknesses of solid films.	50 00
4006.	<b>Cathetometer.</b> To measure small differences of level in liquids, at a distance from the observed column. German form.....	52 50



4008.

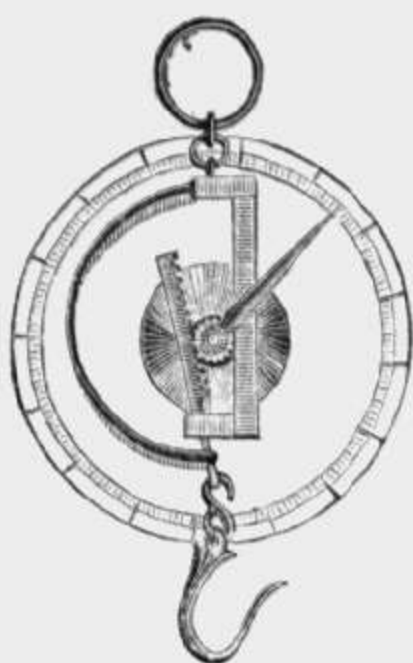

4009.

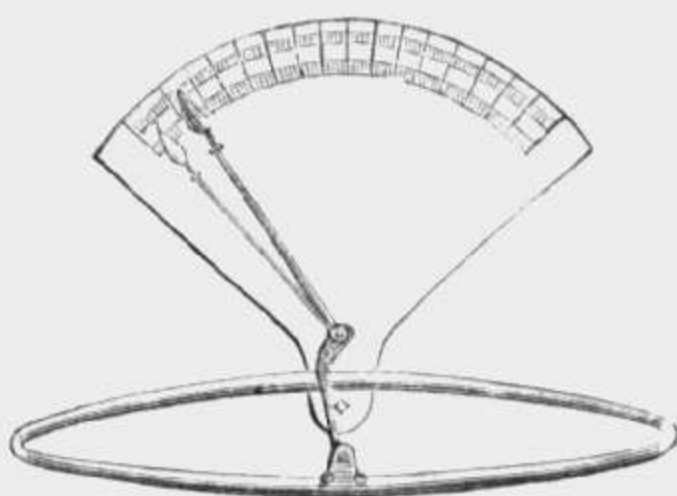

4010.

	PRICE
4008. <b>Leroy's Dynamometer, or Spring Balance.</b> 12 inches long, for measurement of weights up to twenty-five pounds.....	\$5 00
4009. <b>Spring Balance, with dial.</b> For measurement of weights up to twenty pounds.....	15 00
4010. <b>Regnier's Dynamometer.</b> For measurement of powerful forces or weights.....	100 00
4011. <b>Delicate Balance.</b> For the measurement of weights under half a pound. Turns with the $\frac{1}{8}$ of a milligramme, in glass case.....	50 00
4015. <b>Set of Weights.</b> Avoirdupois, four pounds to $\frac{1}{2}$ ounce, in nest, of brass.....	9 00
4016. <b>Set of Weights.</b> Troy, ten ounces to $\frac{1}{2}$ grain.....	9 00
4017. <b>Set of Weights.</b> Apothecary, one troy-ounce to $\frac{1}{4}$ grain, in mahogany case, velvet-lined.....	2 75
4018. <b>Set of Weights.</b> Apothecary, from 1,000 grains to $\frac{1}{10}$ grain.....	7 00
4019. <b>Set of Weights.</b> From 50 grammes to one milligramme, finely finished, in mahogany box, with forceps.....	16 00

SECTION II.—MOLECULAR FORCES.



4015.



4030.

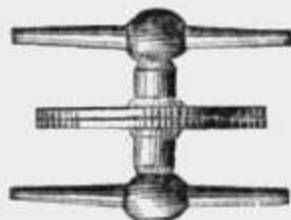

4031.



4032.



4033.

4030. <b>Pair of Cohesion Plates.</b> Of glass, three inches in diameter.....	1 25
4031. <b>Pair of Cohesion Plates.</b> Of brass, three inches in diameter.....	5 00
4032. <b>Pair of Cohesion Hemispheres.</b> Of lead, one and a quarter inches in diameter.....	1 50
4033. <b>Adhesion Disc.</b> Of glass, three inches in diameter, supported by a silk cord at the centre.....	1 25

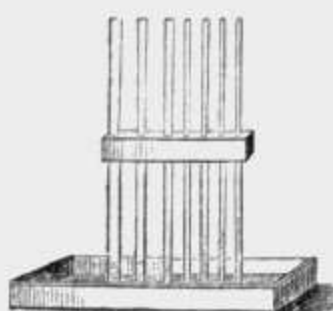

4034.

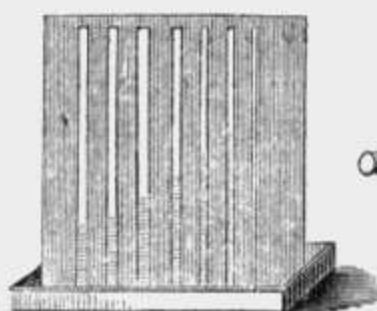

4035.

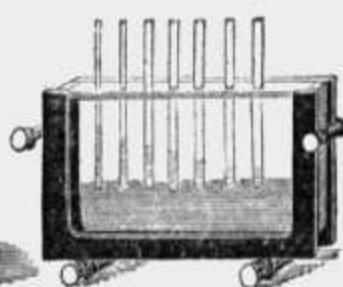

4036.



	PRICE
4034. <b>Capillary Tubes.</b> Set of six, in wooden frame, with tin water-pan..	\$1 50
4035. <b>Capillary Tubes.</b> Set of six, mounted on a tin frame, with water-pan attached .....	2 50
4036. <b>Capillary Tubes.</b> Set of six, mounted in a glass cell, with brass clamps, for the projection of the phenomenon upon a screen.....	5 00
4037. <b>Capillary Plates.</b> A pair, four inches square, of thick, polished plate-glass, with brass clamps and a glass water-cell.....	5 00
4038. <b>Capillary Plates.</b> A pair, four inches square, of thick, polished plate-glass, with brass clamps and metal pan, arranged for projection...	5 00

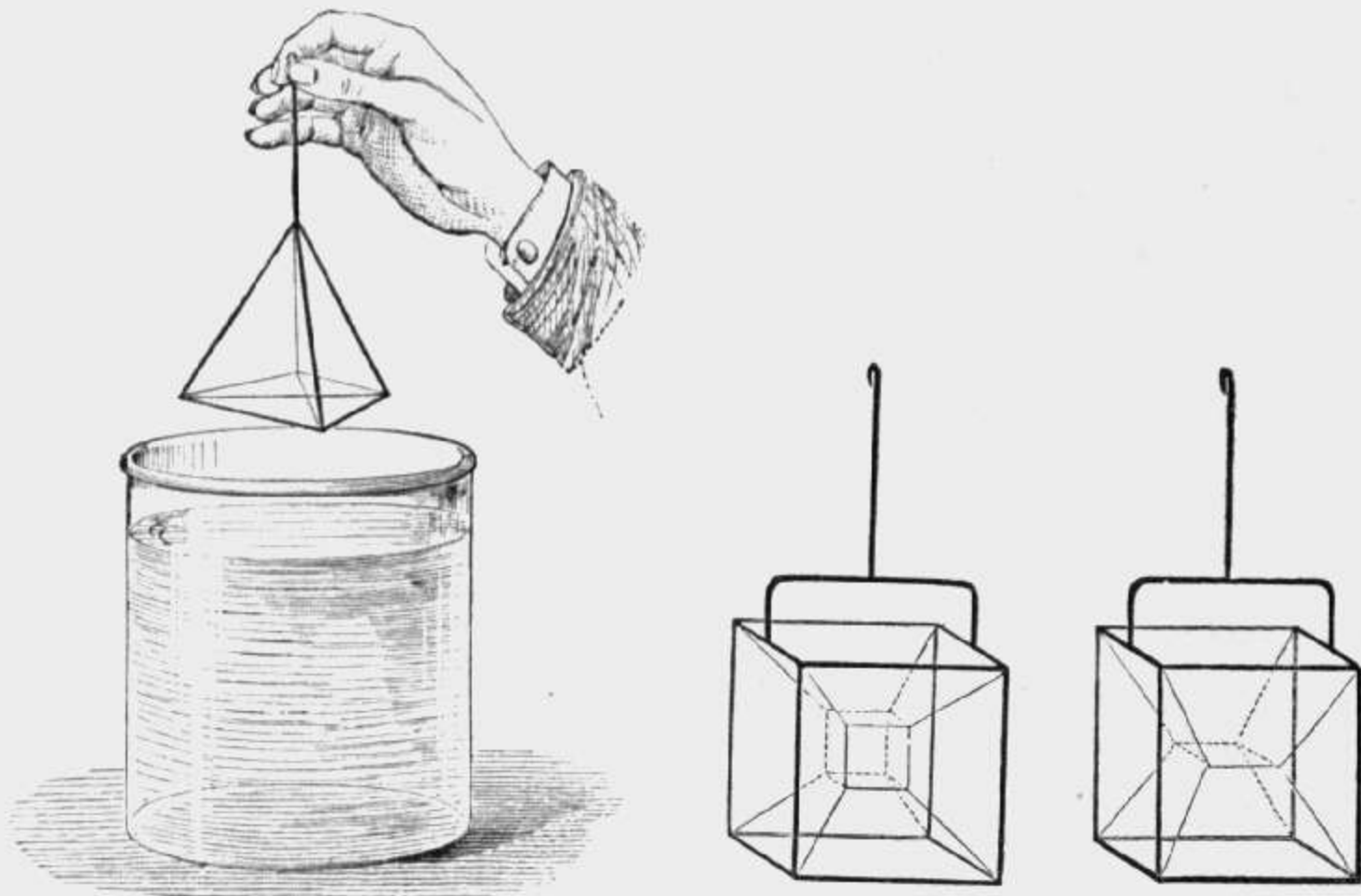

4039.

4039. <b>Cohesion Figures.</b> A series of wire forms, or skeletons, representing the tetrahedron, cube, globe, cylinder, square pyramid, and hexagon, with supports; and a gallon vessel of glass, to be filled with Platteau's mixture of glycerine .....	8 00
4040. <b>Geometrical Forms.</b> Oblate spheroid, prolate spheroid, sphere, hemisphere, triangular prism, hexagonal prism, cylinder, pyramid and frustum, cone and frustum, cubes, parallelopiped, &c., made of white-wood, and neatly finished.....	5 00
4041. <b>Geometrical Forms.</b> Similar to No. 4040, but larger, and made of pear-wood.....	12 50
4042. <b>Models of Crystals.</b> Set of twenty-five forms, of glass, contained in a neat box, about 13 inches by 9, with velvet fitting. The separate pieces vary from one and a quarter inches square, for the cube, to two and a half inches long, for the hexagonal prism; and form altogether the neatest and best set yet devised. The forms are as follows: 1, cube; 2, octahedron; 3, tetrahedron; 4, dodecahedron; 5, pentagonal dodecahedron; 6, trapezohedron; 7 and 8, cube with truncated corners; 9, cube with truncated edges; 10, right-square prism with truncated corners; 11, right-square prism with truncated edges; 12 and 13, square octahedra; 14, rhombic octahedron; 15 and 16, truncated rhombic prisms; 17, rhomboidal prism; 18, obtuse rhombohedron; 19, acute rhombohedron; 20, hexagonal prism; 21, 22, 23, truncated hexagonal prisms; 24, double hexagonal pyramid; and 25, scalene dodecahedron.....	20 00

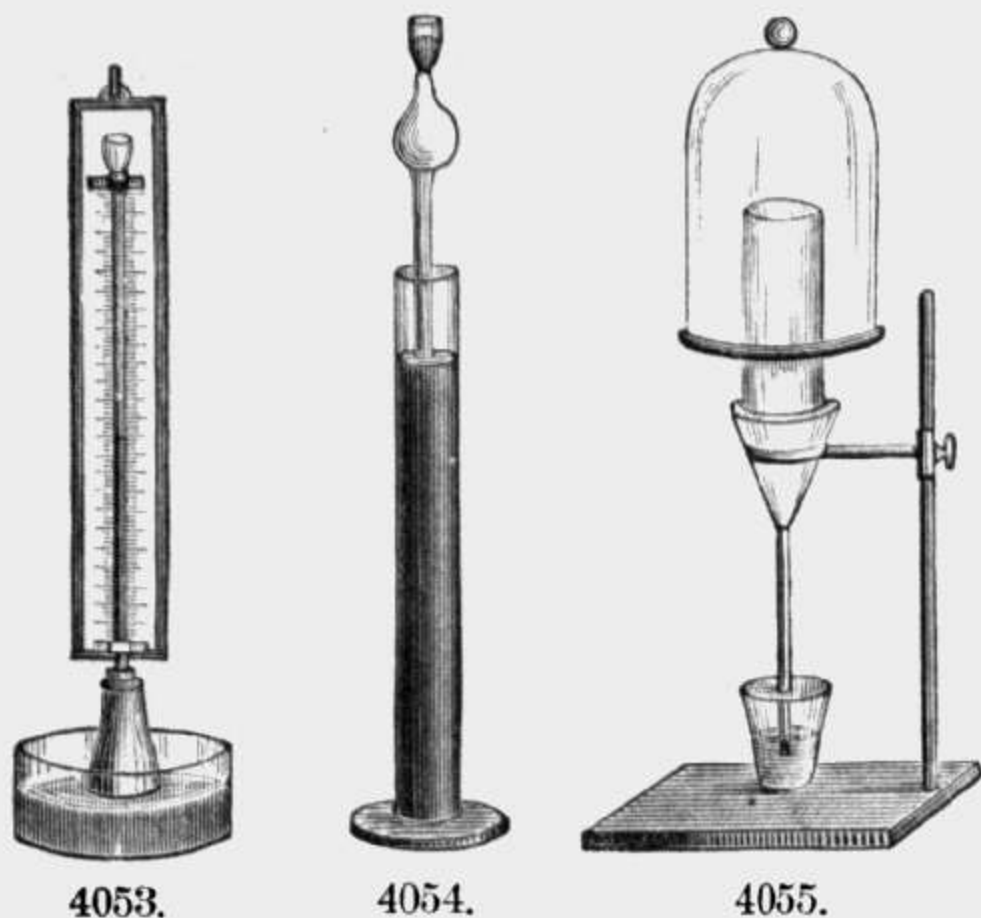

4053.

4054.

4055.

- |   | PRICE  |
|---|--------|
| 4053. <b>Dutrochet's Endosmeter.</b> Consisting of an inverted glass bell, closed at the bottom by a porous membrane, and at the top by a cork carrying a glass tube, with scale. The whole instrument is suspended so that the bell dips into a tank containing that fluid of the two to be experimented upon whose penetrating power is greatest, while the other is poured into the bell and tube..... | \$6 00 |
| 4054. <b>Graham's Diffusimeter.</b> Consisting of a vase for mercury, a glass tube with a ball, and narrow neck, closed by a plug of plaster of Paris..   | 5 00   |
| 4055. <b>Beclard's Endosmeter.</b> Consists of a glass funnel, to which is cemented a porous cup, supported on a firm stand; a bell-glass, and a cup for fluid, accompany the instrument.....   | 5 00   |
| 4056. <b>Oersted's Apparatus</b> for compression of fluids. Consisting of a strong glass cylinder, sixteen inches high by two and three quarters in diameter, with heavy metal base, and cap as shown in the cut. (See p. 5.) A tube with recurved neck, and a metal scale enclosed in the main tube, serve for the registering apparatus.....  | 37 50  |

SECTION III.—ON IMPACT.

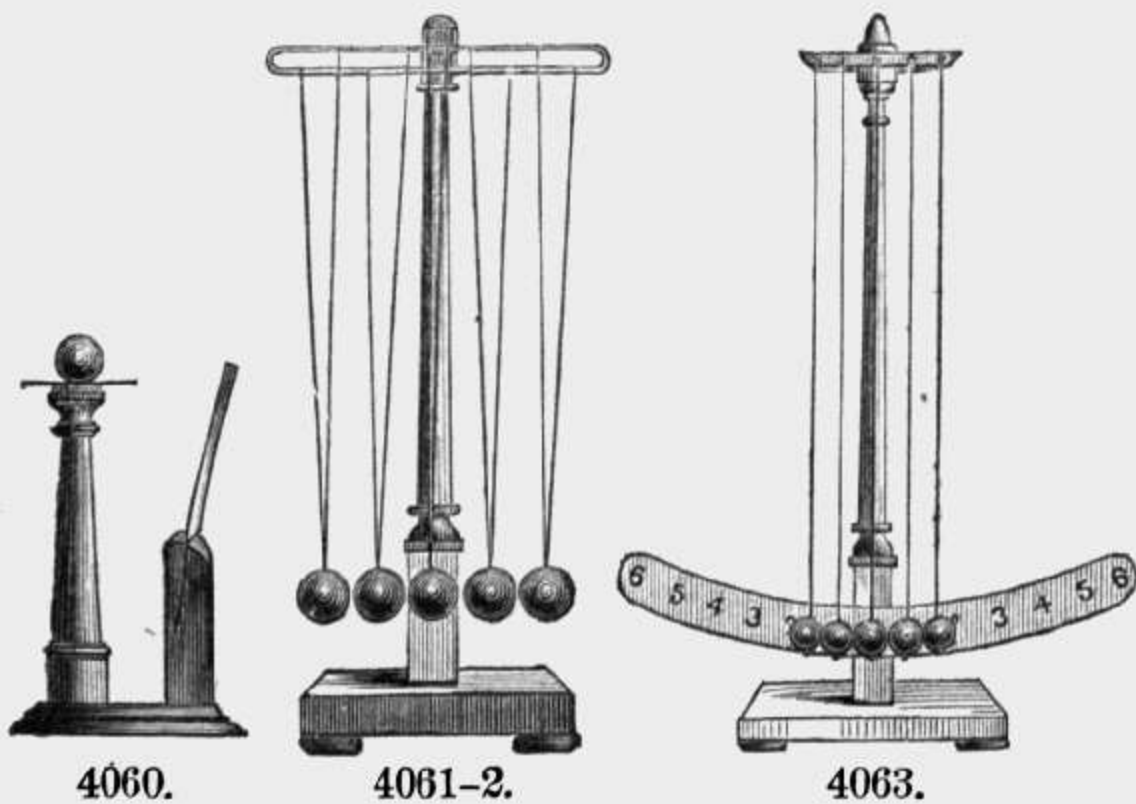

4060.

4061-2.

4063.

- |  |      |
|--|------|
| 4060. <b>Inertia Apparatus.</b> Mahogany stand, with spring, card and ball.... | 1 75 |
|--|------|



PRICE

4061. **Collision Balls.** Set of five highly elastic balls, one and a half inches in diameter, mounted with double cords on a mahogany frame, thirty inches high..... \$6 00
4062. **Collision Balls.** Set of five ivory balls, one and a quarter inches in diameter, mounted with double cords on a mahogany frame, thirty inches high..... 14 00
4063. **Collision Balls.** Set of five imitation ivory balls of the highest attainable elasticity, two and a half inches in diameter, and accurately spherical, mounted with double cords on a strong mahogany frame, three and a half feet high, with graduated arc.. 30 00

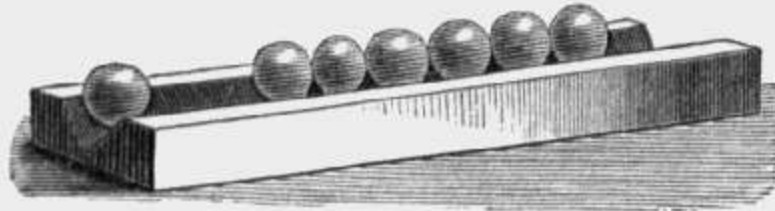

4064.

4064. **Collision Balls.** Set of seven glass balls, one and a half inches in diameter, with a groove in a mahogany base, one metre in length.. 5 00
4065. **Collision Plate.** A slab of marble, one foot square, in wooden frame, and a ball of ivory, one and a quarter inches in diameter..... 8 00

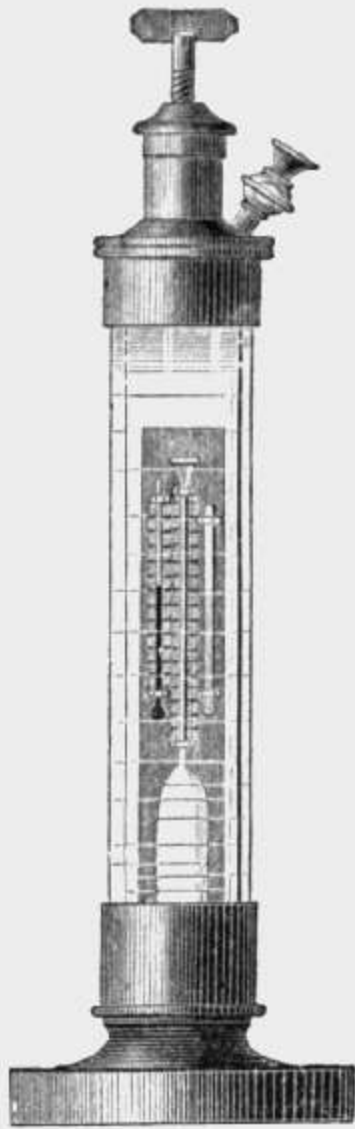

4056.

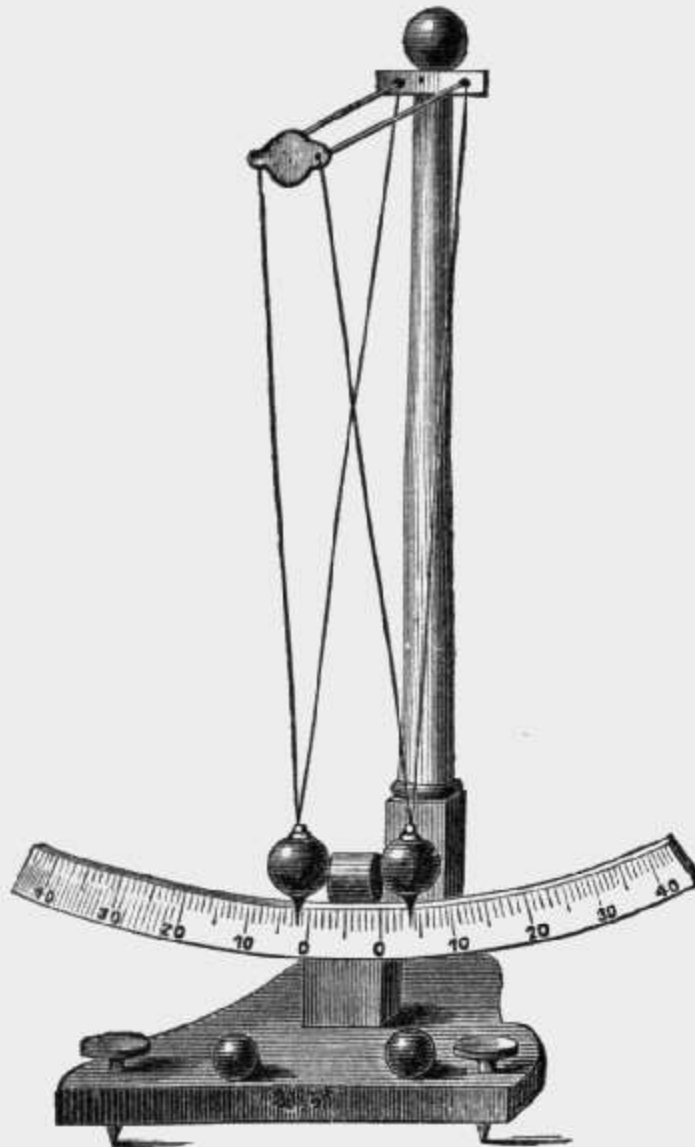

4066.

4066. **Complete Apparatus** for the demonstration of the laws of impact, both in elastic and non-elastic bodies. Consists of a post of mahogany, three feet and a half high, with graduated arc; on a firm base of the same material, supporting by double cords of silk the following:
- 1st. Two elastic balls, each two and a half inches in diameter, of precisely equal masses.

- 2d. One elastic ball, of exactly half the mass of each of the former.
  - 2d. One elastic ball, of exactly one quarter the mass of the same.
  - 4th. Two non-elastic balls, each two and a half inches in diameter, of exactly equal masses.
  - 5th. One non-elastic ball, of exactly half the mass of each of the former.
- A spring pistol is so adjusted on the base between the balls, as to strike both at the same instant with equal force. It can be removed entirely when necessary.....

\$60 00

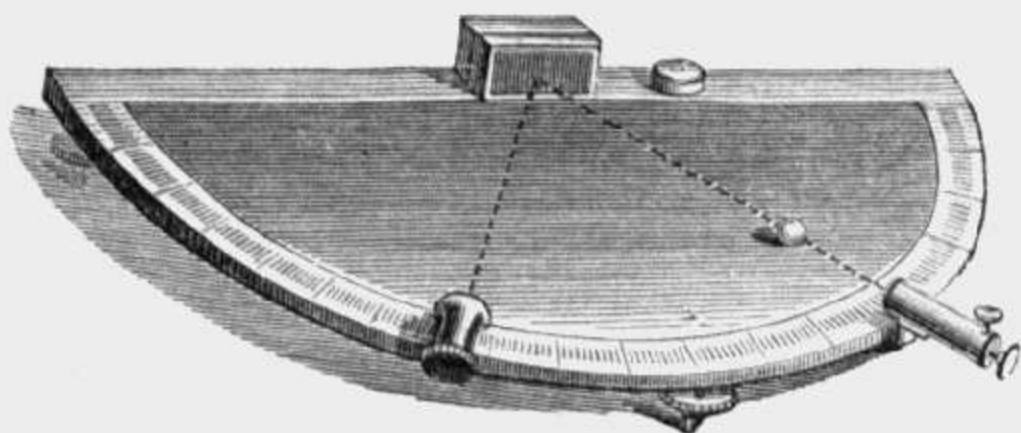

4069.

4069. **Apparatus to Illustrate the Reflexion of Motion.** Consisting of a semicircular table of cherry, a marble slab for reflector, a spring pistol, ivory ball, and pocket to catch the ball after the rebound. Edge of table graduated to show the relation between angles of incidence and reflexion.....

25 00

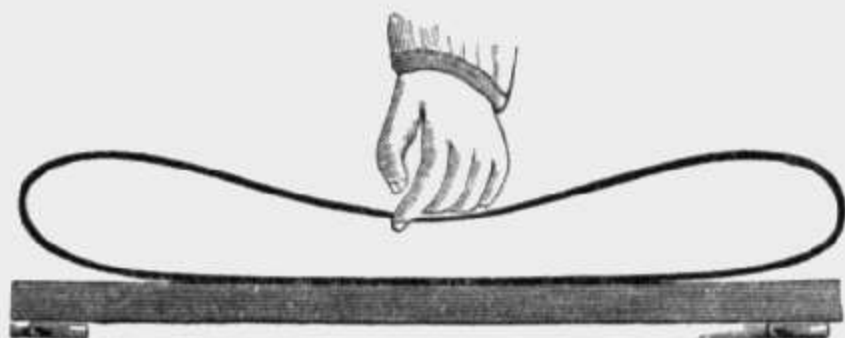

4070.

4070. **Hoop of Brass,** to illustrate the alternate expansion and contraction of an elastic body, when compressed and then set free. On base of polished mahogany.....

5 00

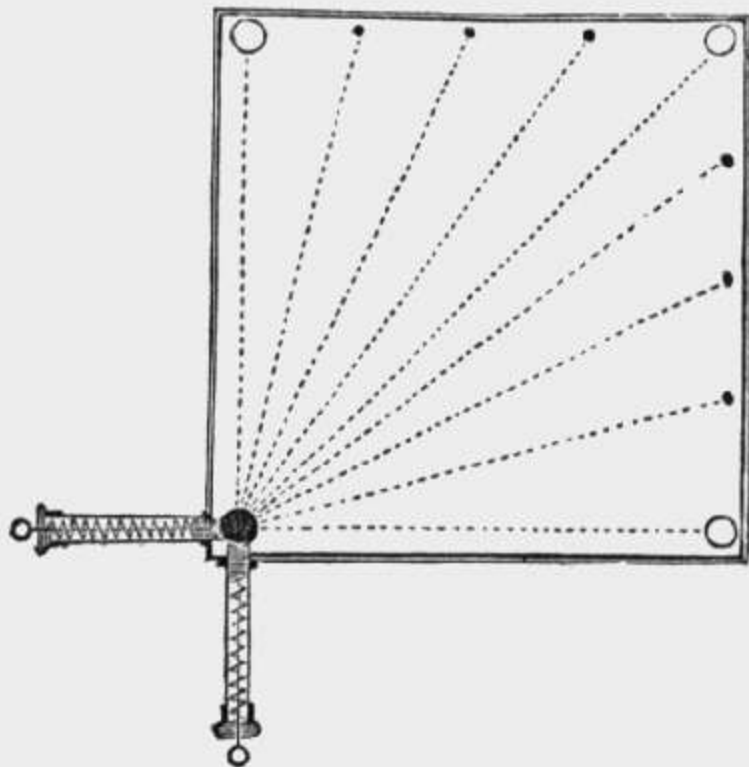

4071.

INSTRUMENTS ILLUSTRATING ROTARY OR TANGENTIAL FORCES. 7

- |   | PRICE   |
|---|---------|
| 4071. <b>Resultant Table.</b> A table of mahogany, eighteen inches square, with spring pistols and ball.....  | \$10 00 |
| 4072. <b>Resultant Table.</b> Same as preceding, but with an arrangement for drawing the pistols with any proportionate force, and for discharging them simultaneously .. | 30 00   |

SECTION IV.

INSTRUMENTS ILLUSTRATING ROTARY OR TANGENTIAL FORCES.

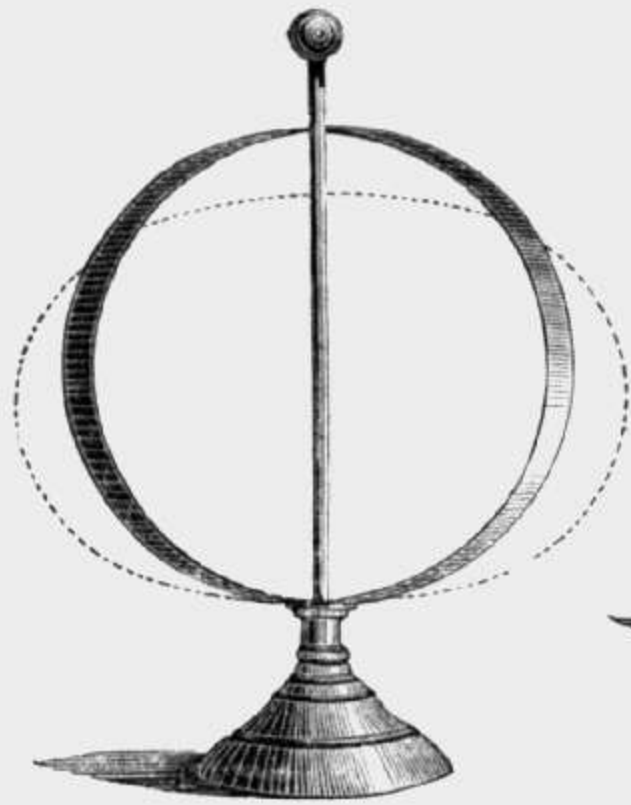

4075.

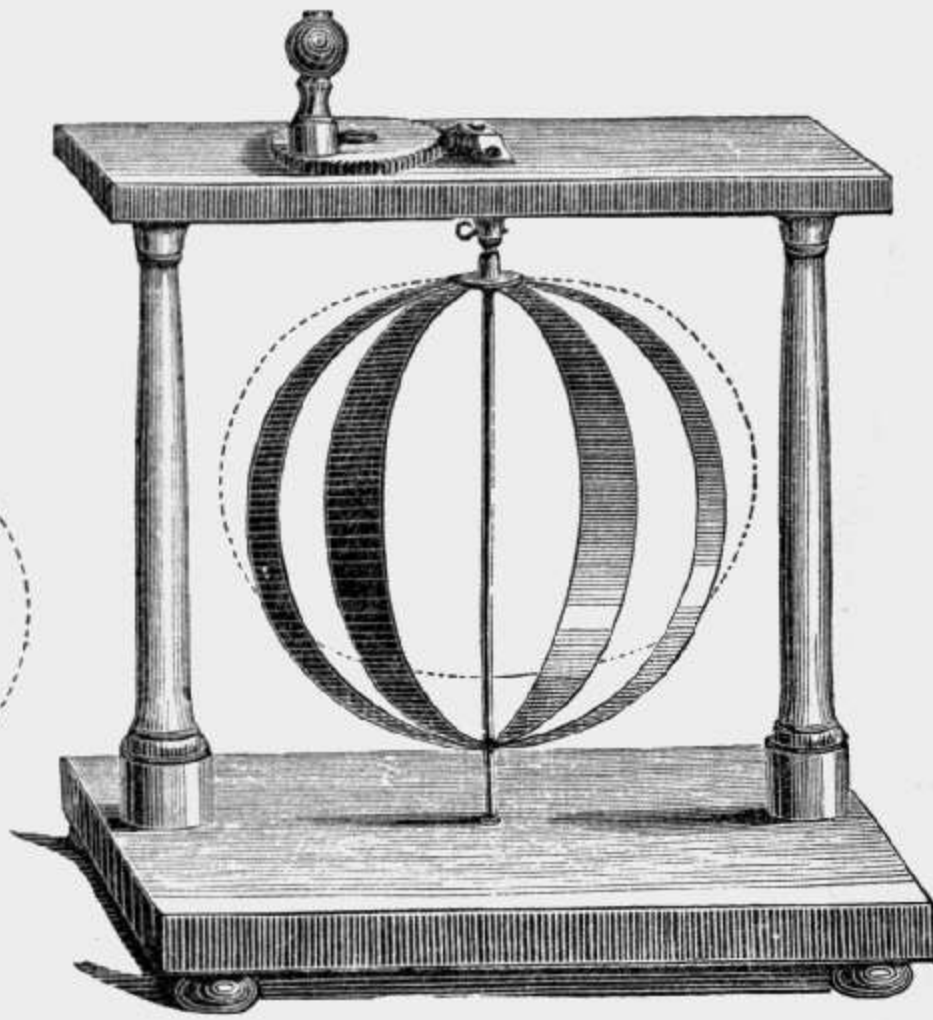

4076.

- |  |       |
|--|-------|
| 4075. <b>Whirling Machine.</b> A single hoop of spring brass, nine inches in diameter, with spool and cord for spinning. On a firm base and vertical rod of iron.....  | 4 50  |
| 4076. <b>Whirling Machine.</b> Table, 15½ inches high, by 17 inches wide. Eight illustrations. Consisting of double hoop of spring brass; a globe, oblate spheroid, prolate spheroid, and double cone of wood; a ring and a chain of brass, and a glass vessel containing mercury and a colored fluid..... | 12 00 |
| 4077. <b>Prismatic Cylinder.</b> Of wood, four inches in diameter and covered with paper of the seven primary colors. To be attached to whirling machine No. 4076.....   | 3 00  |



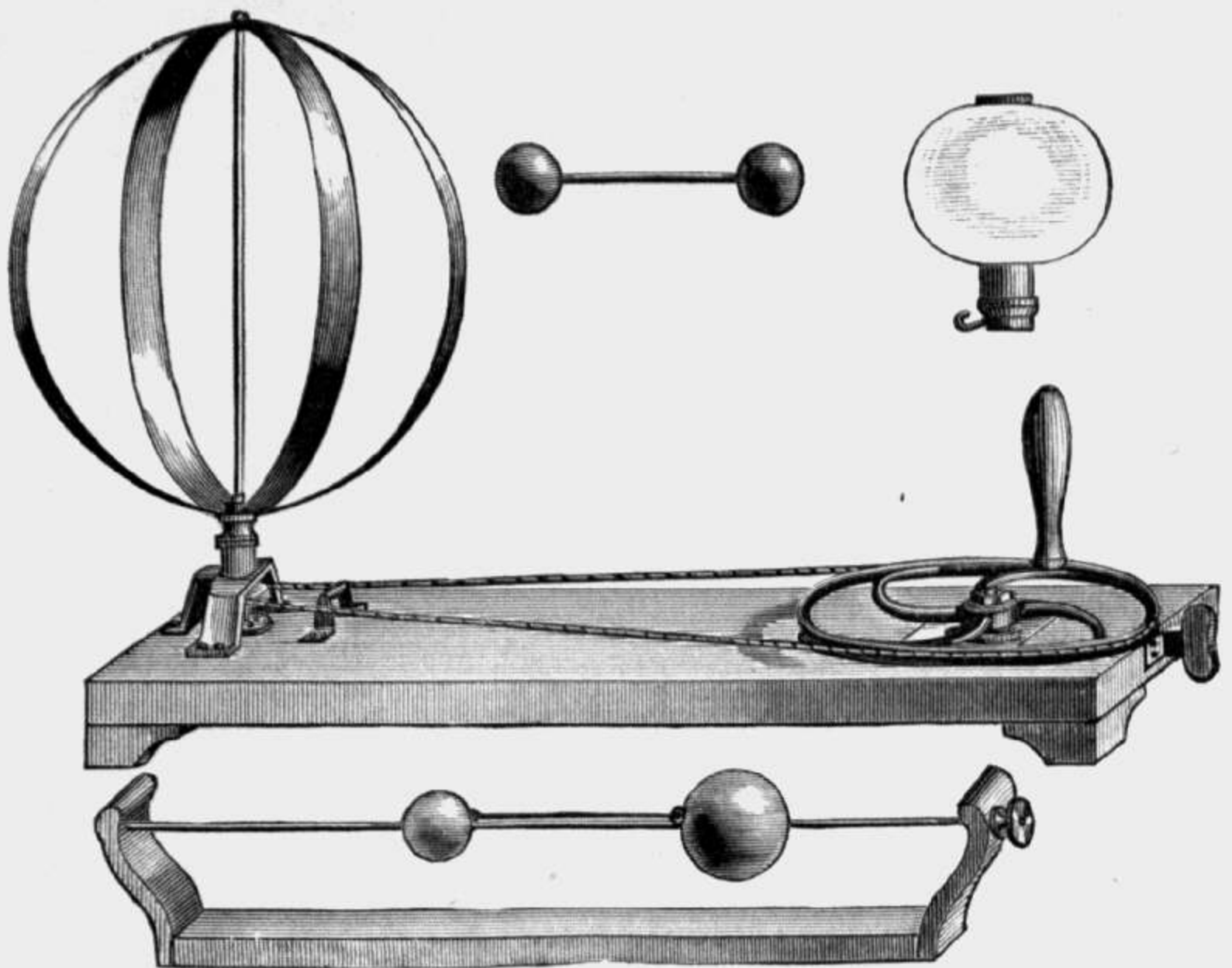

4078

PRICE

4078. **Whirling Table.** A strong base of mahogany, three and a half feet long, with iron driving-wheel, metallic spindles, accurately ground to their fittings, screw arrangement for tightening or loosening the cord and screw attachments, with key for fastening to the spindle :  
 1st. Double brass ring, twelve inches in diameter.  
 2d. Vase, open, for mercury, water, and other fluids of varying density.  
 3d. A strong mahogany frame, on which is stretched a wire, two equal balls connected by a tube, and two unequal ones connected by a strong rubber cord.  
 4th. A heavy ring of brass, from the top of which may be suspended a brass chain or ring, or wooden figures, as in No. 4076. \$40 00  
 Or finally, any of the following apparatus for rotation :

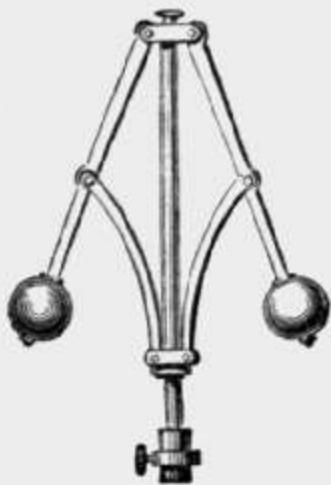

4079.

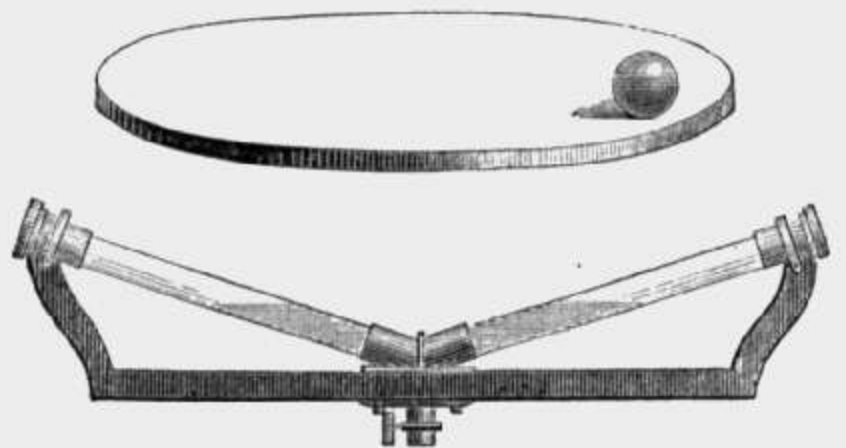

4080 and 4081.

4079. <b>Model of Steam Governor</b> , to be attached to No. 4078 .....	10 00
4080. <b>Frame with Inclined Glass Tubes.</b> For liquids of different densities, to be attached to No. 4078.....	10 00
4081. <b>Inertia Table.</b> With heavy wooden ball attached to the centre by a cord. To be attached to No. 4078.....	5 00





4082.

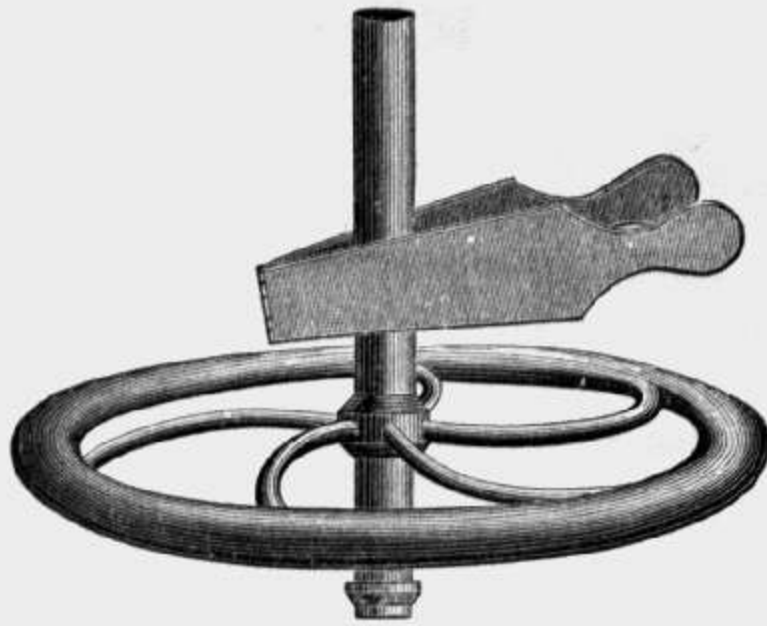

4083.

- |   | PRICE  |
|---|--------|
| 4082. <b>Globe of Glass, with Cork.</b> To show air-bubble at centre by attaching to No. 4078.....  | \$5 00 |
| 4083. <b>Heavy Fly-Wheel of Iron.</b> With screw attachments above and below, for attaching it to No. 4078, and for attaching various instruments to it, when steadiness and uniformity of rotation is necessary..... | 10 00  |

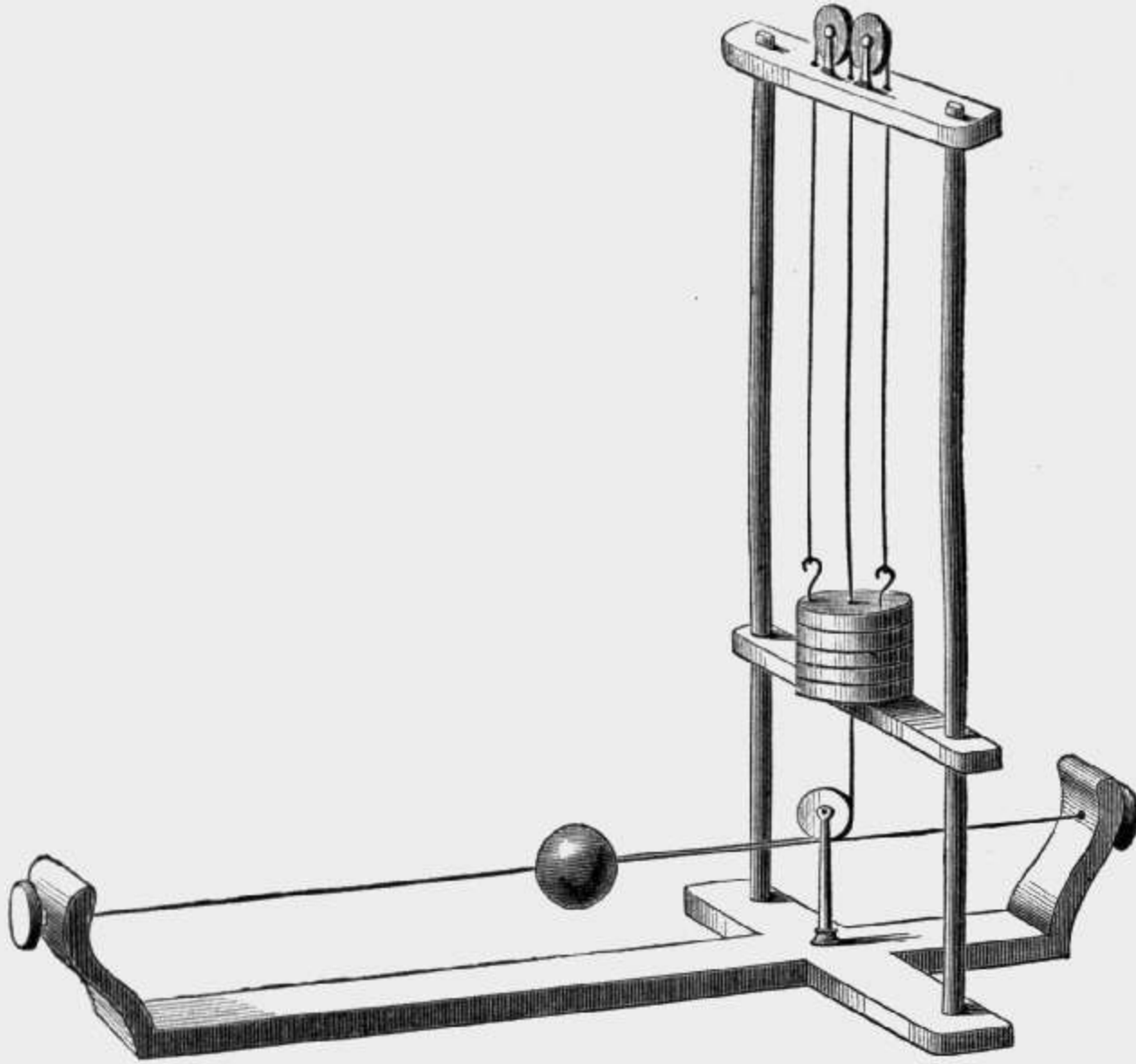

4084.

- |   |       |
|---|-------|
| 4084. <b>Instrument for Determining the Laws of Centrifugal Force.</b> To be attached to No. 4078.....  | 15 00 |
| 4085. <b>Register.</b> To be attached to the whirling table No. 4078, so that the exact number of revolutions per second can at any time be noted. This, with the fly-wheel, No. 4083, places the whole question of central forces under exact measurement..... |       |

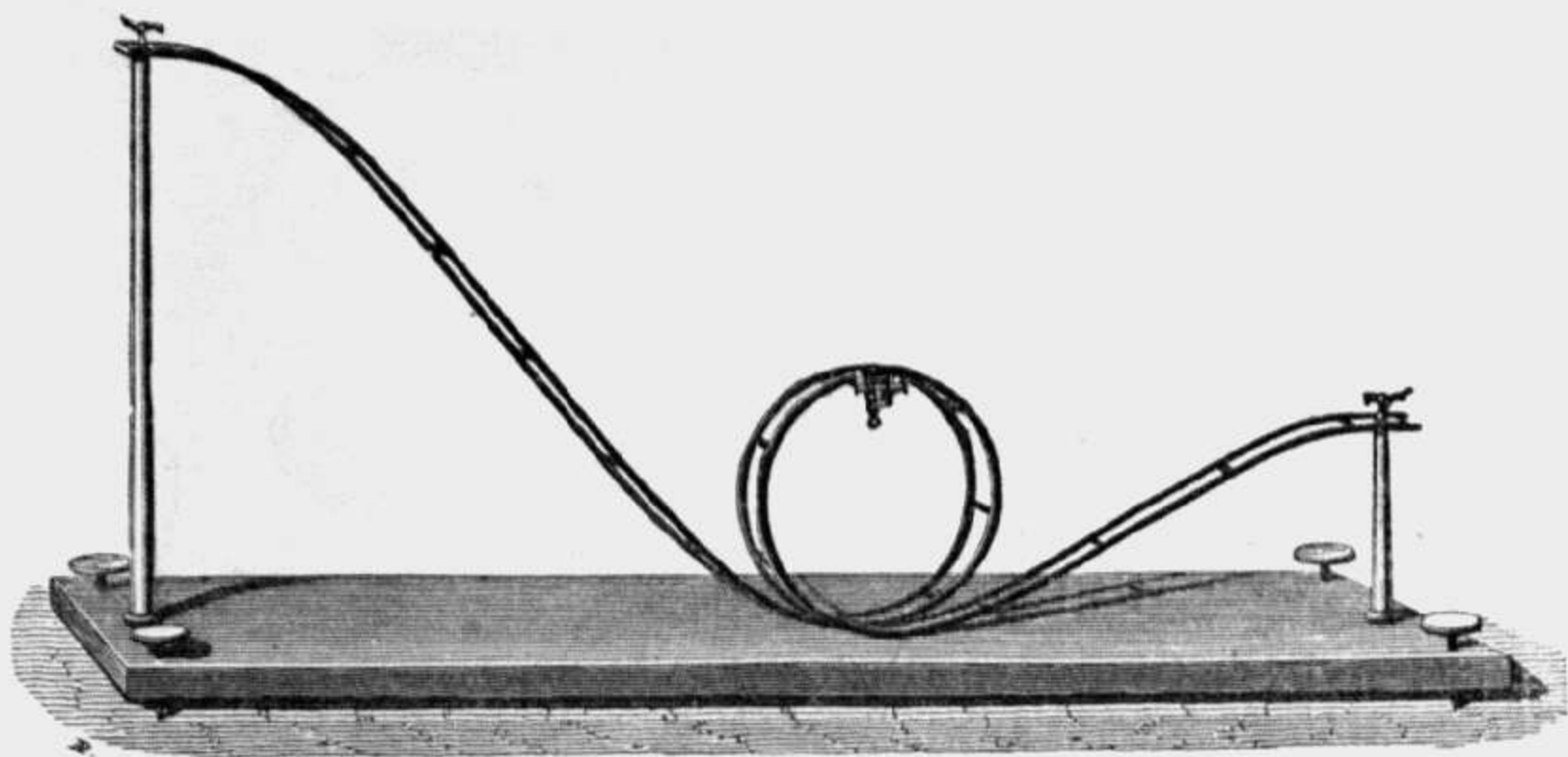

4087.

- |   | PRICE  |
|---|--------|
| 4086. Centrifugal Railroad. Of neatly japanned tin, three feet in length, with a ball.....                                    | \$4 00 |
| 4087. Centrifugal Railroad. Four feet long, of neatly japanned tin, on a wooden base with leveling screws and glass ball..... | 10 00  |

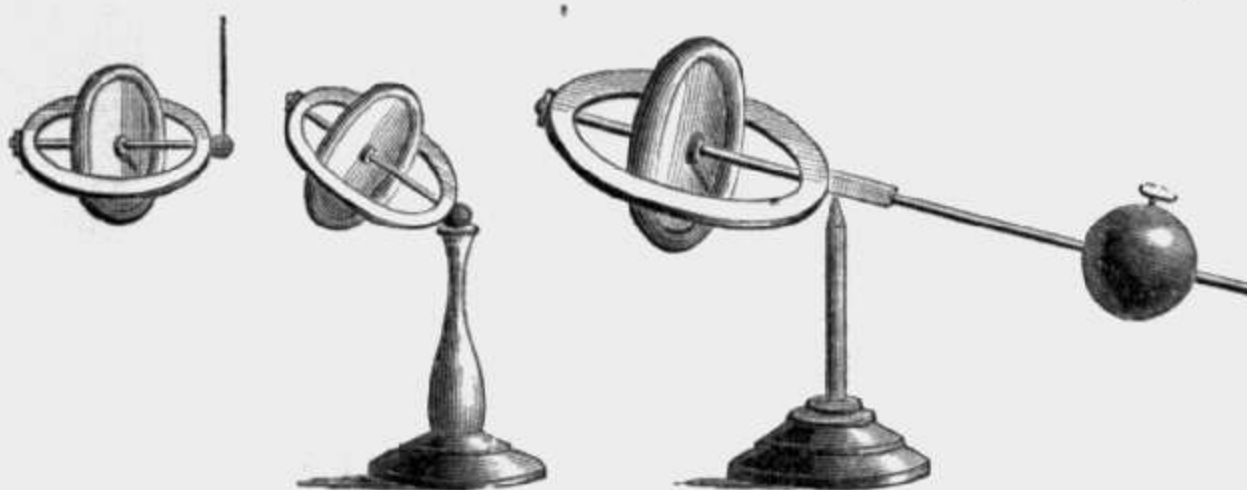

4088.

4089 and 4090.

- |   |       |
|---|-------|
| 4088. Gyroscope Top. Wheel, 2½ inches in diameter.....  | 2 50  |
| 4089. Gyroscope. With three-inch wheel, of brass, with lever and balance-weight, supported on an upright pointed post of steel..... | 8 00  |
| 4090. Gyroscope. Similar to No. 4089, but with brass wheel four inches in diameter.....   | 10 00 |

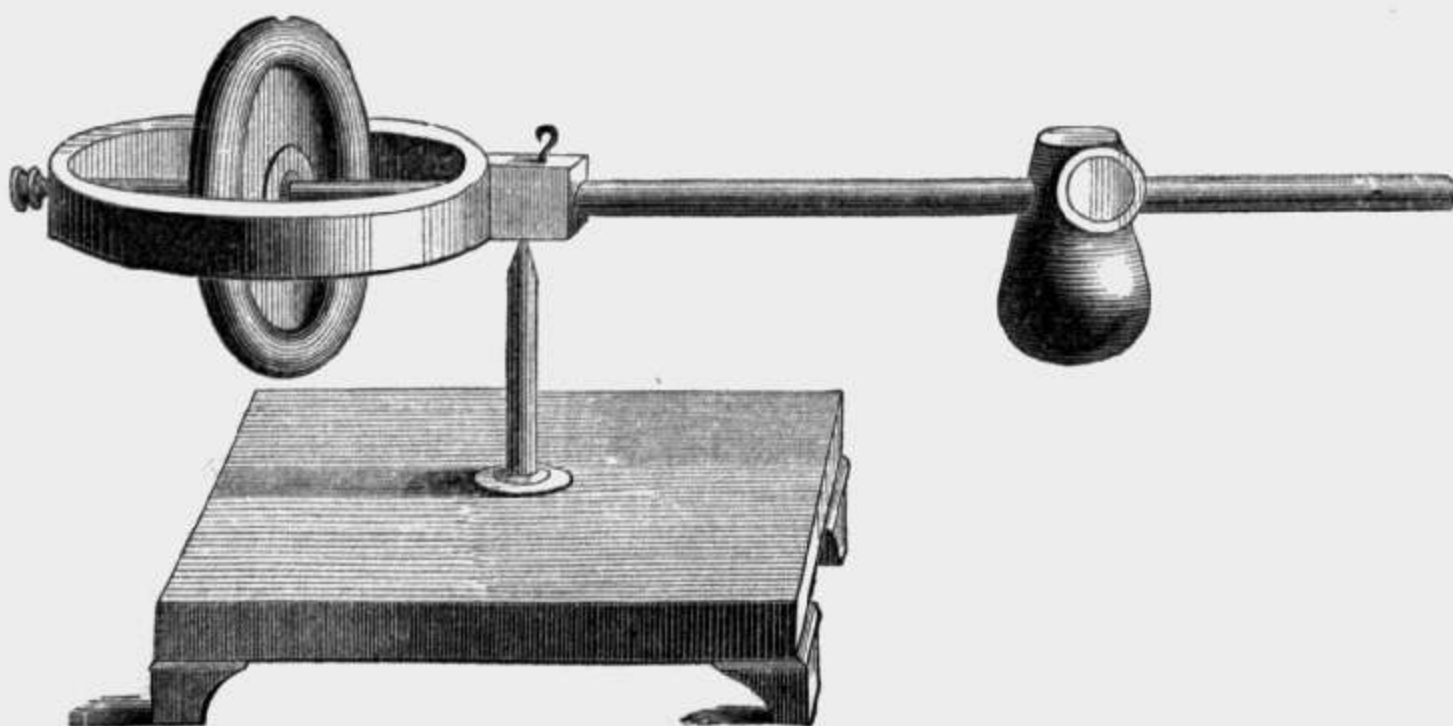

4091.

PRICE

4091. **Gyroscope.** Very superior. Wheel of brass, six inches in diameter, lever of brass, balance-weight of iron. This instrument admits of a smaller (three-inch wheel) gyroscope being attached to end of lever, and shows then the combined rotations very neatly. Supported on a strong steel upright and pointed post, fastened to a heavy base of polished mahogany..... \$30 00



4092.

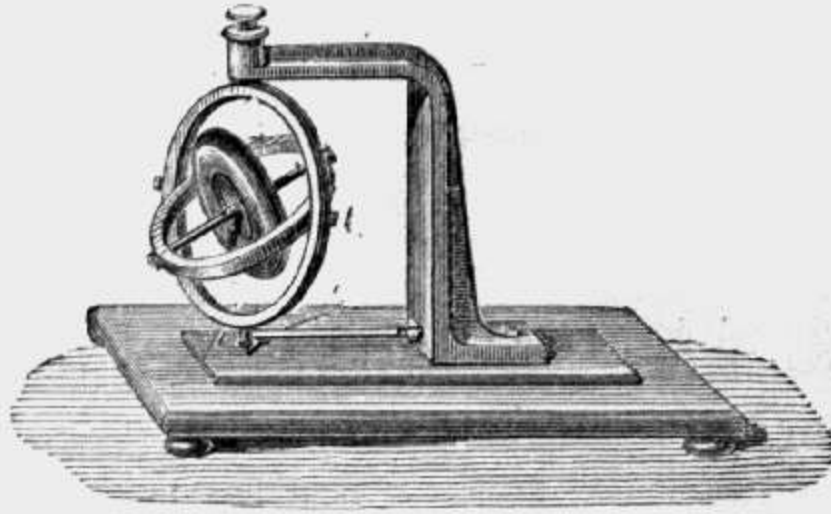

4093.

4092. **Bohnenberger's Apparatus.** All of brass, except axis and vertical support, which are of steel. Wheel four inches in diameter..... 16 00
4093. **Hardy's Inverting Gyroscope.** Base of mahogany, pillar and supporting arm of iron, neatly japanned, wheels of brass, four inches in diameter, with set of rubber cords..... 20 00

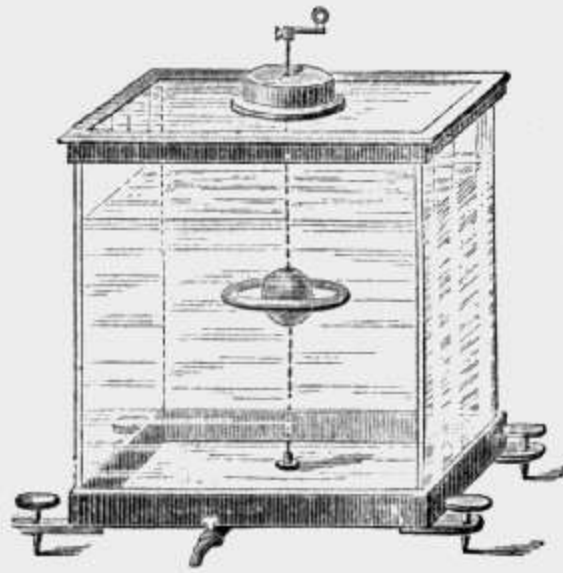

4095.

4095. **Plateau's Apparatus.** For showing the effects of rotation when the influence of terrestrial gravitation is removed. A glass tank, with vertical axle, crank, and disc..... 25 00

## CHAPTER II.

## INSTRUMENTS ILLUSTRATING THE PRINCIPLES OF MACHINERY.

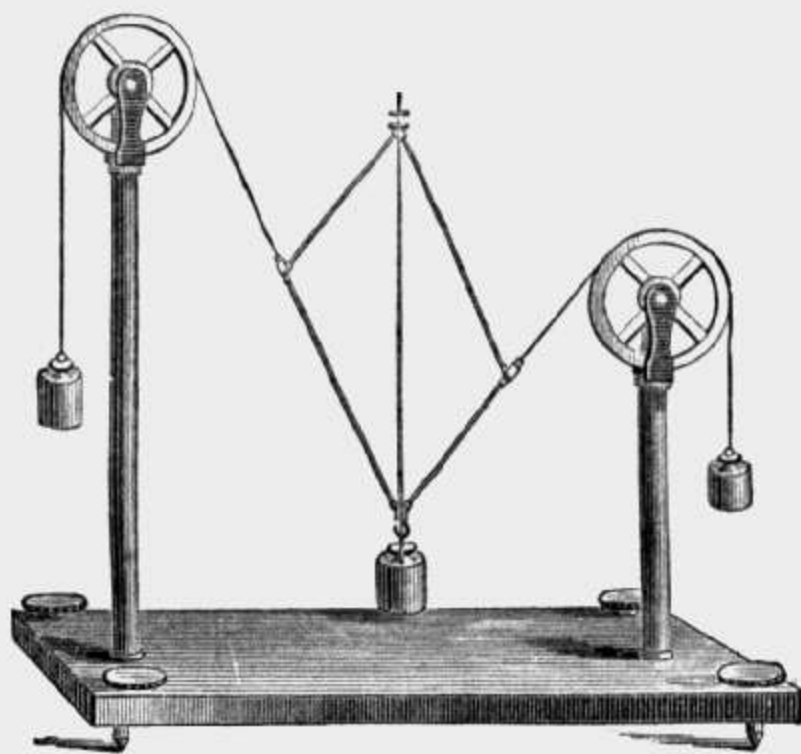

4101.

- |   |                 |
|---|-----------------|
| 4100. <b>Parallelogram of Forces.</b> A light, graduated hinged frame, without weights or pulleys, but with cord extensions. . . . .  | PRICE<br>\$5 00 |
| 4101. <b>Parallelogram of Forces.</b> Very accurately and delicately made. Consisting of a very light, graduated frame with hinged joint; a pair of pulleys with bearings as perfect as possible, with set of weights, twelve in number, and each weighing two ounces. The whole supported upon two brass posts, eighteen and twelve inches in respective height, on base of polished mahogany. . . . . | 25 00           |



4103. **Illustration of Pulleys.** Polished base of mahogany, from which rises a post of the same material, 26 inches high, with arm from which the systems are suspended one at a time; brass pulleys mounted with strong silk cord; each system counterpoised. The weights are made accurate, so that each system performs its work perfectly.

1st System. Fixed pulley, power and weight equal.

2d. One fixed and one movable pulley, power and weight, 1 : 2.

3d. One fixed and three movable pulleys, power and weight, 1 : 2, 1 : 4, or 1 : 8.

4th. One double fixed and one double movable pulley, in blocks, power and weight, 1 : 4.

5th. Capstan, with cord attached to 4th system.

6th. Wheel and axle, three radii, in proportion of 1, 2 and 4.

Set of weights from two to thirty-two ounces; smaller of brass, larger of iron. . . . . \$30 00

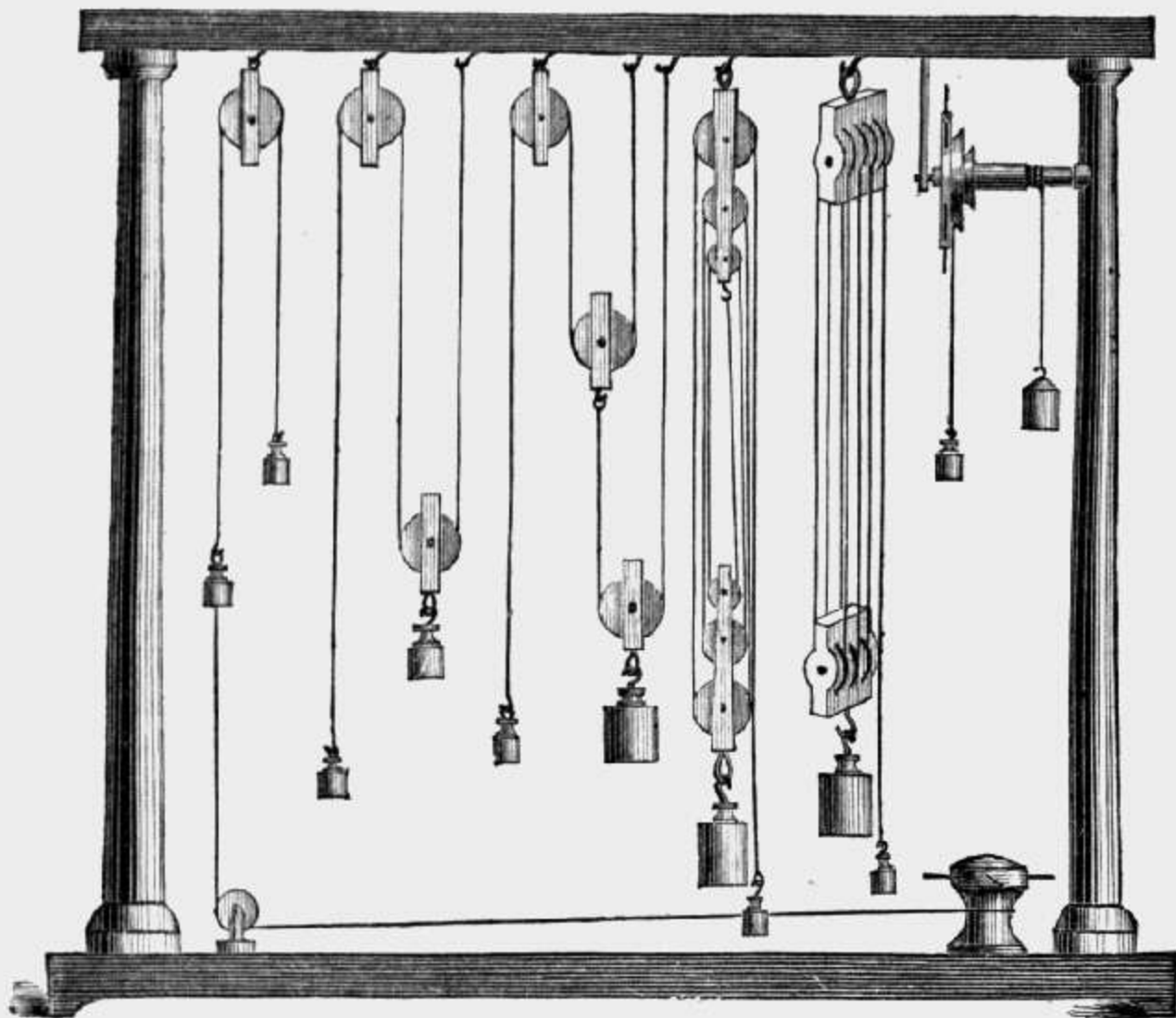

4104.

4104. **Illustration of Pulleys.** Polished mahogany frame, thirty inches long by thirty-six inches high; pulley-wheels of brass, two inches in diameter, mounted with strong silk cord. Each system counterpoised; every part, including the weights, made with the greatest accuracy, so that all the systems illustrate their respective laws with precision.

1st system. Fixed pulley, power and weight equal.

2d system. One fixed and one movable pulley, power and weight, 1 : 2.

3d system. One fixed and two movable pulleys, power and weight, 1 : 2 and 1 : 4.

4th system. One fixed block of three pulleys of different sizes, and one movable pulley of same character, power and weight, 1 : 6.

5th system. One fixed block with four pulleys of same size, and one movable of same kind, power and weight, 1 : 8.

6th system. Wheel and axle, three radii in proportion of 1, 2, and 4.

7th system. Capstan, cord attached to 1st system of pulleys.  
Set of brass weights from one ounce to thirty-two ounces..... \$50 00

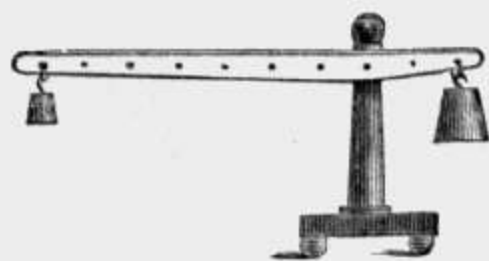

4106.

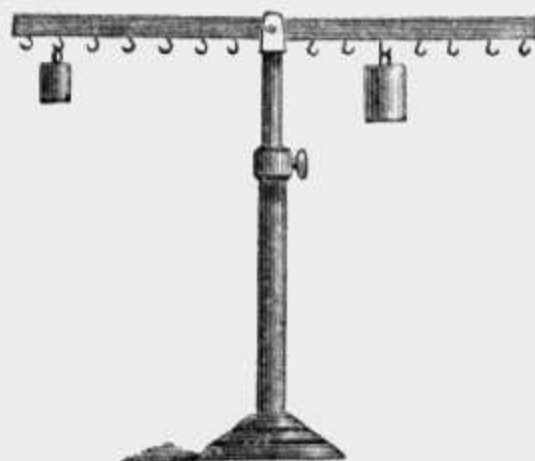

4107.

4105. **Simple Lever, with Fulcrum.** ..... 1 75

4106. **Simple Lever.** Of brass, eight inches long, mounted on a pivot in a base of mahogany, weights of brass, one, two and four ounces. .... 5 00

4107. **Simple Lever and Steelyard.** Beam of brass, twelve inches long, mounted on brass post, with friction points; weights of brass, one, two, four and eight ounces; an additional two-ounce weight to show equilibrium at equal distances from the fulcrum..... 10 00

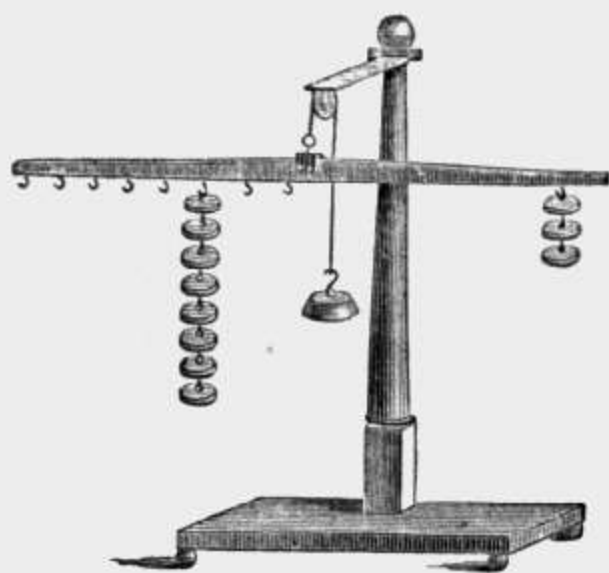

4108.

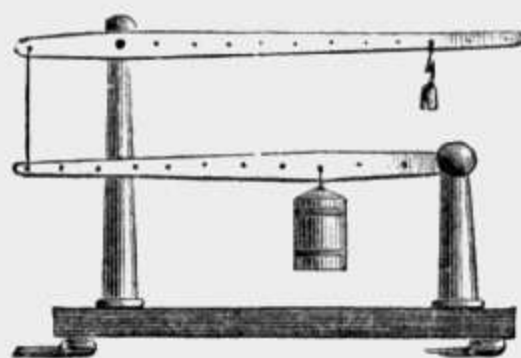

4110.

4108. **Lever Balance.** Mahogany beam, one metre long, suspended by a cord and pulley from an arm in a mahogany frame, and balanced by a weight; weights of brass of one, two, four, eight and sixteen ounces; duplicate four-ounce..... 20 00



4111 and 4112.

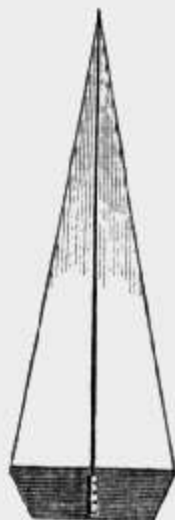

4113 and 4114.

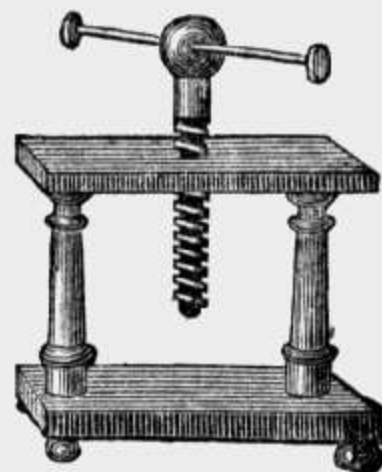

4115 and 4116.

GRAVITATION.

15

	PRICE
4109. <b>Compound Levers.</b> Base, pillar, and levers of mahogany.....	\$5 50
4110. <b>Compound Levers.</b> Base and posts of mahogany, beams of brass, weights of brass and iron, from two ounces to a pound.....	11 00
4111. <b>Inclined Plane with Car.</b> Plane fourteen inches long, of cherry, and adjustable to any angle with the base, by a graduated quadrant and binding screw; wheels of car, pulleys, and weights of brass; weights one, two, four and eight ounces.....	7 50
4112. <b>Inclined Plane with Car.</b> Base and frame of polished mahogany; plane twenty inches long, of plate-glass; pulleys and weights, from one to eight ounces, of brass.....	12 00
4113. <b>Wedge of Cherry.</b> Eight inches long, in two parts, hinged.....	1 00
4114. <b>Wedge of Mahogany.</b> Twelve inches long, in two parts, hinged....	2 50
4115. <b>Screw.</b> Six inches long, in frame of cherry.....	2 00
4116. <b>Screw.</b> Ten inches long, in frame of finely polished mahogany.....	6 00

---

CHAPTER III.

GRAVITATION.

SECTION 1.—INSTRUMENTS FOR DETERMINING THE FORCE OF GRAVITY.

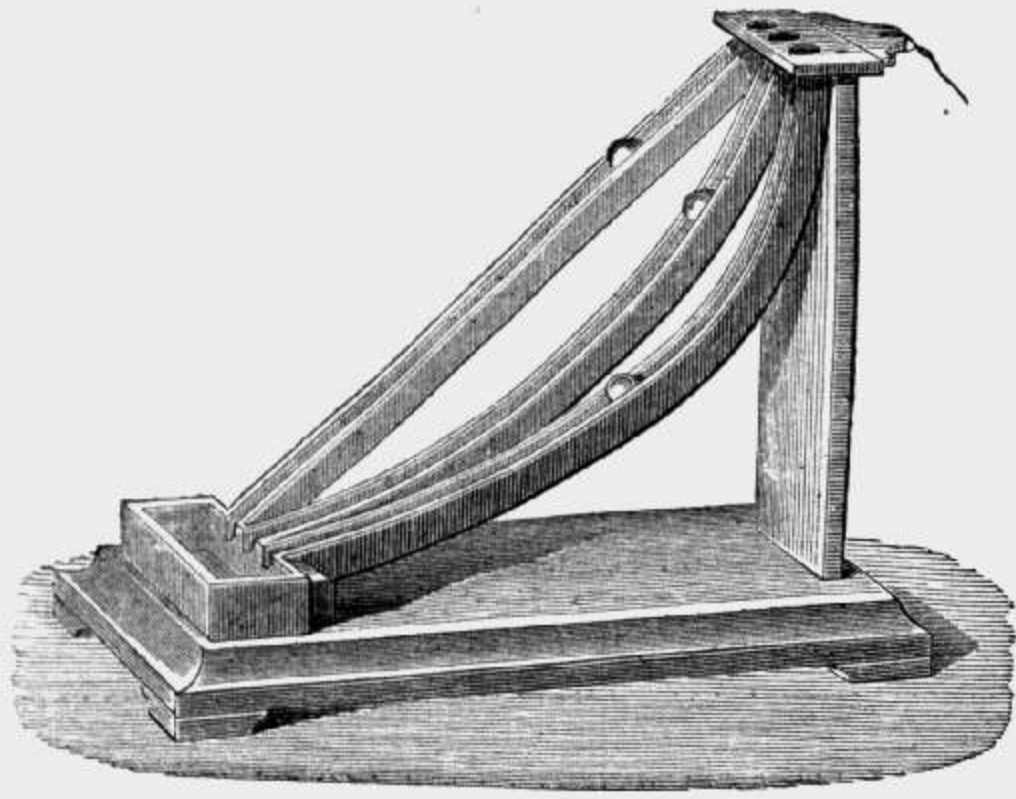

4124.

4124. <b>Swiftest Descent Apparatus.</b> Consisting of a mahogany frame, four feet on base, carrying three inclined planes; one a straight plane, one a circular, and one a cycloidal, with arrangement for starting three balls at the same instant, and a box to catch them at the end of their course.....	25 00
---	-------



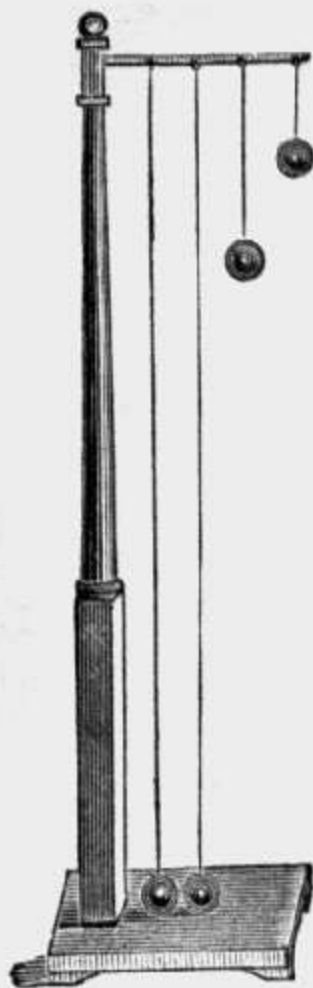

4125.

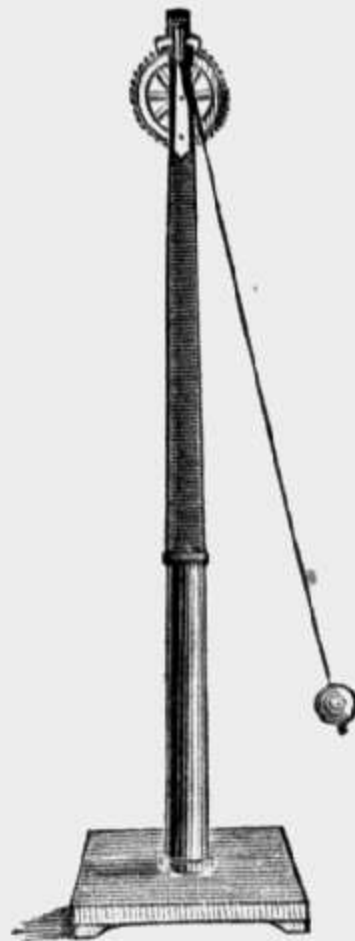

4126.

	PRICE
4125. <b>Pendulum Apparatus.</b> Base and pillar of polished mahogany, with arm of brass, supporting two seconds' pendulums, one with solid brass ball, the other with a hollow one, each two inches in diameter; and two other pendulums, with solid balls, one one-fourth, the other one-ninth the length of the seconds' pendulum.....	\$12 00
4126. <b>Seconds' Pendulum, with Clock Escapement.</b> Mounted on mahogany base and stand. Pendulum with dead beat.....	25 00
4127. <b>Atwood's Machine, with Automatic Movement.</b> Strong pillar of polished mahogany on base of the same material, with leveling screws. Pulley-wheel eight inches in diameter, with steel axis working in delicate screw bearings. Side graduated scale, carrying sliding platforms of brass. Clock with seconds' pendulum with dead beat, which releases the falling weight as the index of the dial passes 0. Weights for momentum.....	80 00
4128. <b>Atwood's Machine, with Automatic Movement.</b> Strong pillar of polished mahogany on base of the same material, with leveling screws. Pulley-wheel eight inches in diameter, with steel axis, working on delicate pivots. Side graduated scale, carrying sliding platforms of brass. Pendulum beating seconds, which rings at every stroke a small bell. A simple contrivance starts the weight at the instant the pendulum passes the perpendicular; at every subsequent passage it rings the bell. Weight for momentum in three equal sections.....	100 00
4129. <b>Atwood's Machine.</b> Same as No. 4127, but with an electro-magnetic connection, to release the weight at the proper instant, and ring the bell.....	140 00
4130. <b>Set of friction wheels and glass cover for either of the Atwood Machines.</b> .....	40 00



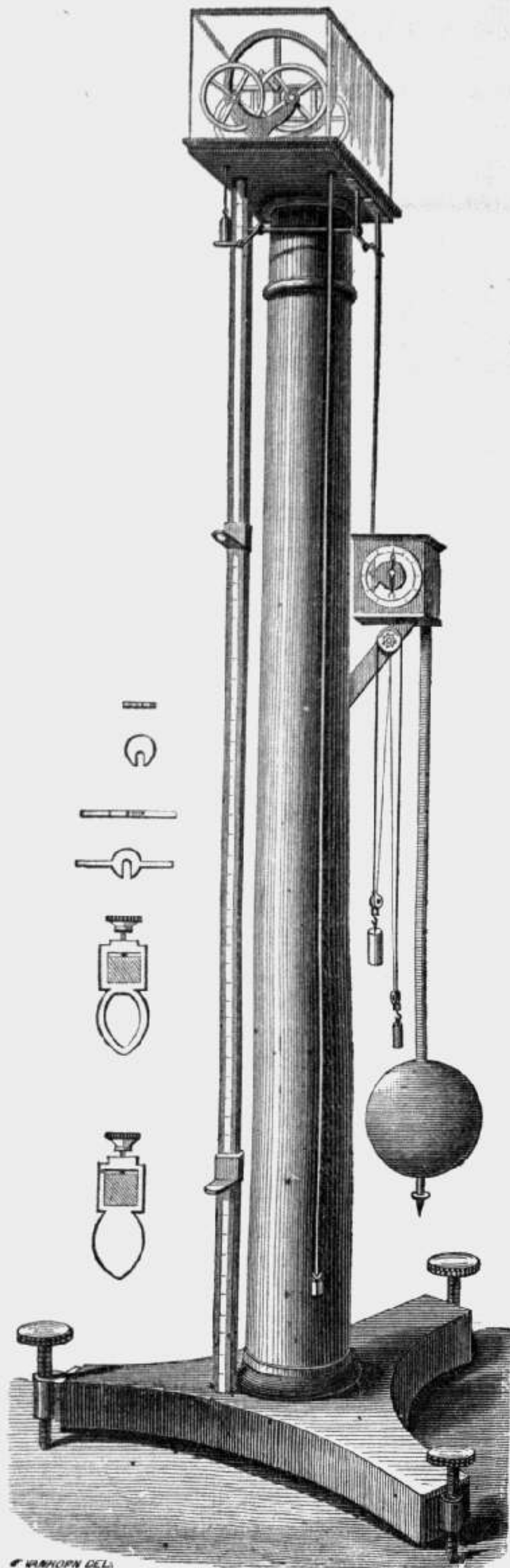

4127 and 4130.

SECTION II.—CENTRE OF GRAVITY, OR EQUILIBRIUM OF SOLIDS

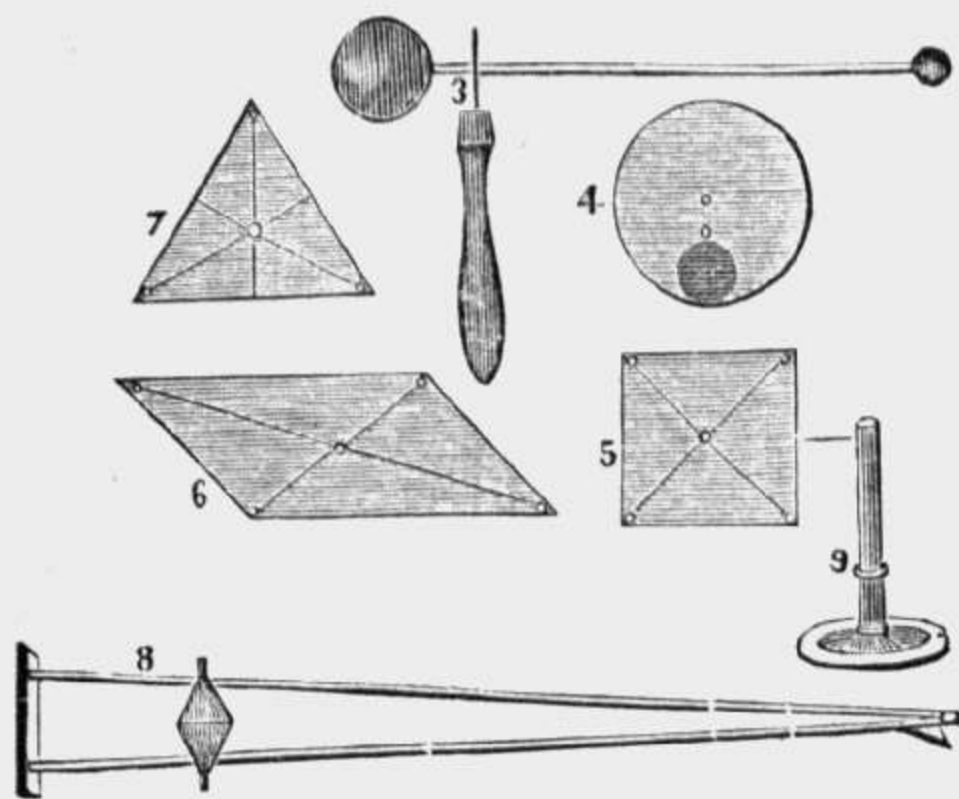

4140.

4140. **Centre of Gravity.** A set of nine illustrations, consisting of a cone, plumb-line, leaning tower, with two centres of gravity; three blocks of different figures, with centres of gravity and suspension marked on them; loaded wheel, with holes for suspension at centre of figure and centre of gravity; double cone, on inclined plane; figure of horse or man, balanced; two balls, connected by a rod pierced at the centre of gravity of the pair, and a handle for suspension.....

PRICE

\$12 00



4144.



4145.

- |  |      |
|--|------|
| 4142. <b>Mechanical Paradox.</b> A double cone and frame of mahogany.....    | 1 50 |
| 4143. <b>Leaning Tower.</b> With two centres of gravity.....                 | 1 25 |
| 4144. <b>A Blondin.</b> Balanced on one foot, on neat mahogany stand.....    | 2 50 |
| 4145. <b>The Waltzers.</b> A pair of figures, attached to a convex lens..... | 1 00 |

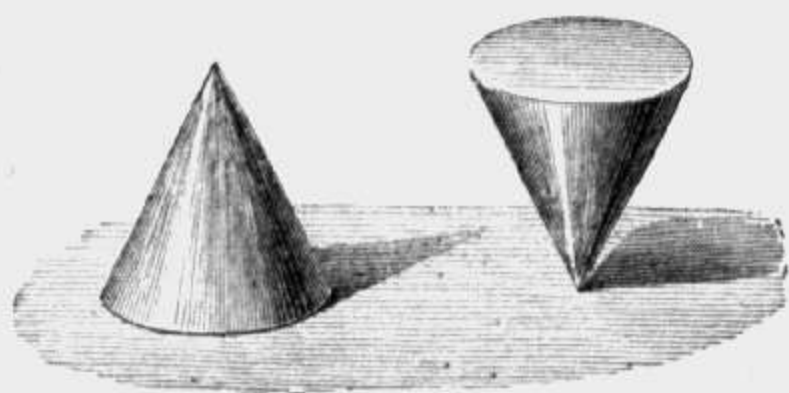

4146.

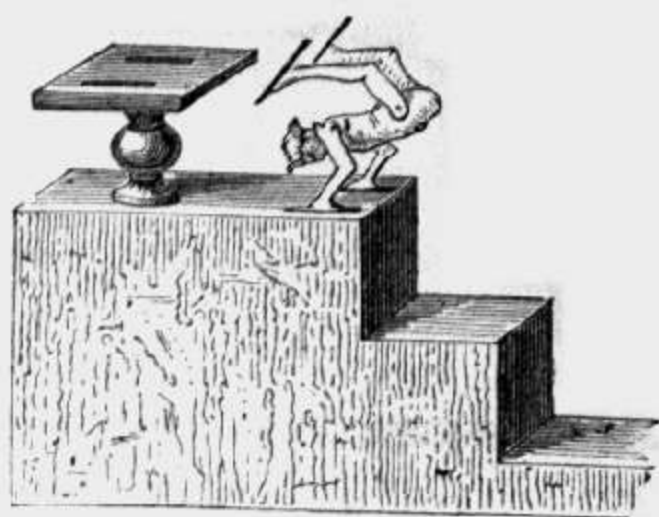

4147

- |  |        |
|--|--------|
| 4146. <b>Equilibrium Figures.</b> Two cones of cherry, each four inches high.. | PRICE  |
| 4147. <b>Chinese Tumblers.</b> Stairs 10 inches long at base.....              | \$1 50 |
| 4148. <b>Chinese Tumblers.</b> Stairs 12 inches long .....                     |        |
| 4149. <b>Chinese Tumblers.</b> Stairs 14 inches long .....                     |        |

SECTION III.—EQUILIBRIUM OF LIQUIDS AND SPECIFIC GRAVITY.

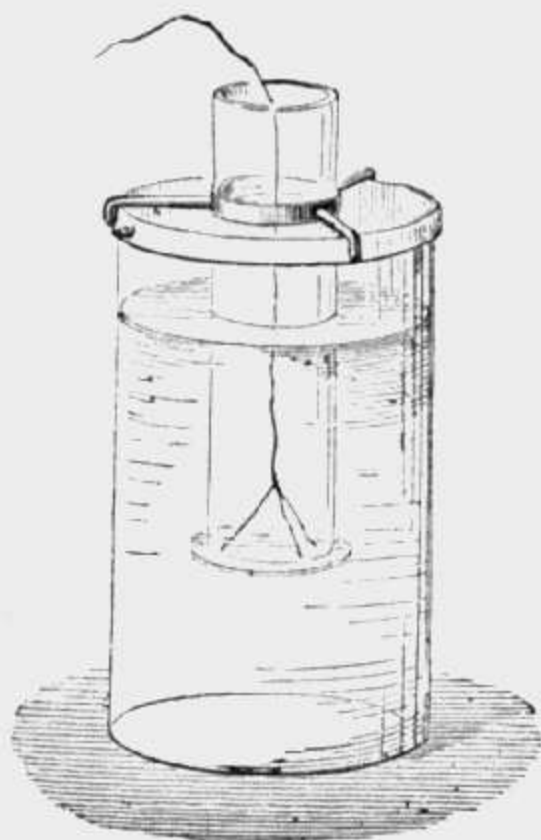

4161.

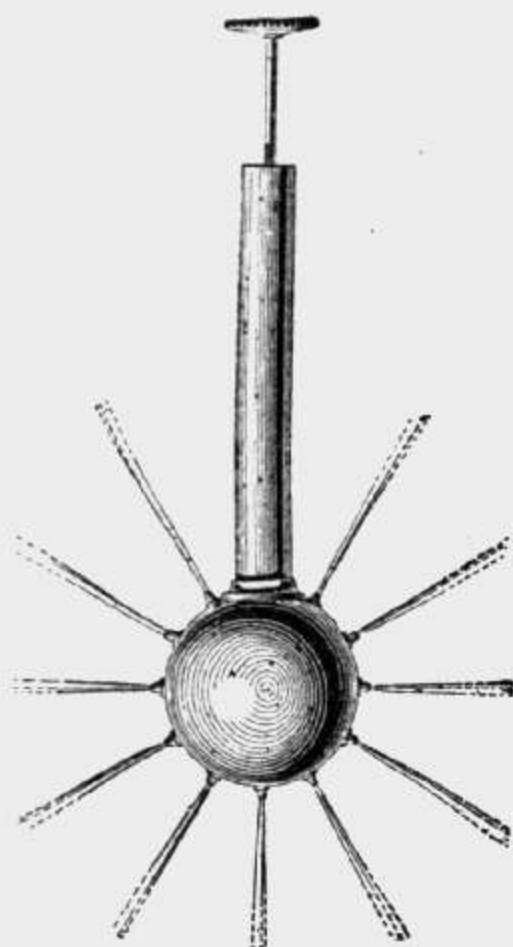

4162.

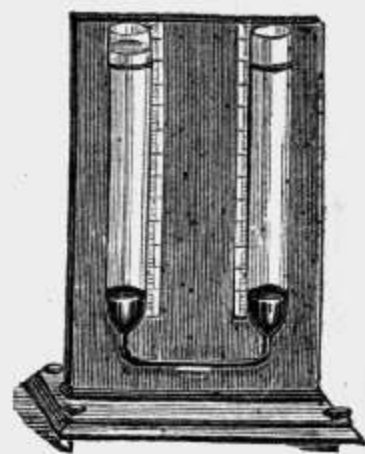

4165.

- |  |       |
|--|-------|
| 4160. <b>Upward Pressure Apparatus.</b> Glass tube with ground flange at one end, and a brass plate with cord attached, without frame or water-jar.....  | 3 00  |
| 4161. <b>Upward Pressure Apparatus.</b> Same as No. 4160, but with a gallon vessel of glass, and a strong frame to support the tube, as shown in the figure.....   | 6 00  |
| 4162. <b>Apparatus to Demonstrate the Equality of Pressure in all Directions.</b> Brass bulb, four inches in diameter, with apertures (closed with corks), and a brass cylinder eight inches long and one and a quarter inches in diameter, with piston..... | 20 00 |



	PRICE
4163. <b>Equilibrium Tubes.</b> Set of six forms, six inches high, mounted in a base of tin neatly japanned.....	\$4 50
4164. <b>Equilibrium Tubes.</b> Set of six forms six inches high, in brass sockets, screwing into fittings in a connecting tube of brass, on a mahogany base.....	12 00
4165. <b>Equilibrium Tubes for different liquids.</b> Pair of glass tubes, seven inches high, cemented into iron fittings which are connected by a small iron tube; mounted on a neat mahogany frame, with graduated scale on each arm.....	10 00

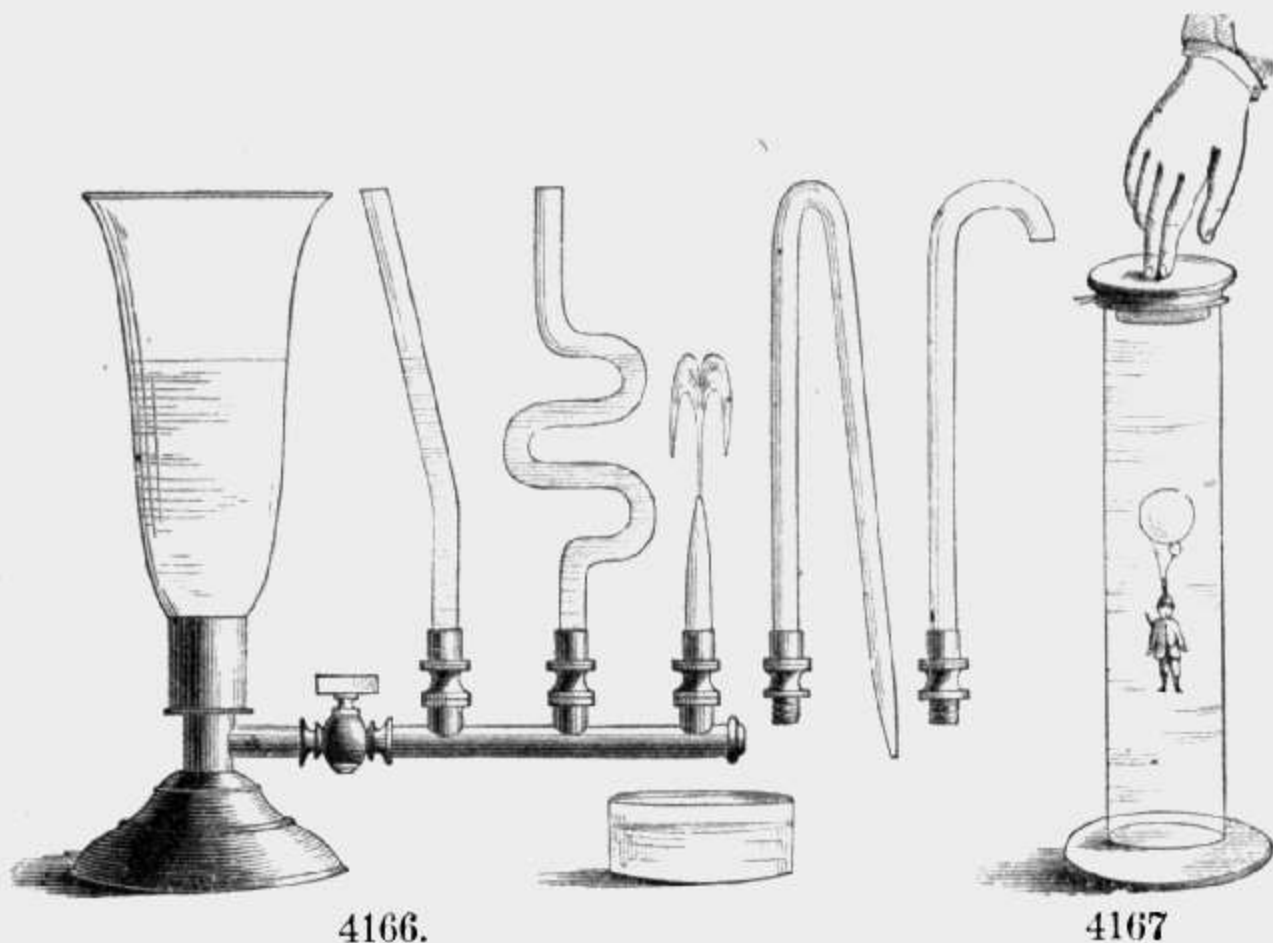

4166. <b>Equilibrium Vases.</b> A set of six forms, ten inches high, of glass, in brass sockets, with brass connecting tube, mounted on heavy iron base.....	15 00
4167. <b>Balloon and Car.</b> With jar fifteen inches high.....	5 00
4168. <b>Balloon and Car.</b> Without jar of No. 4167.....	3 50
4169. <b>Bottle imp.</b> With bottle.....	2 00
4170. <b>Bottle imp.</b> Without bottle.....	75

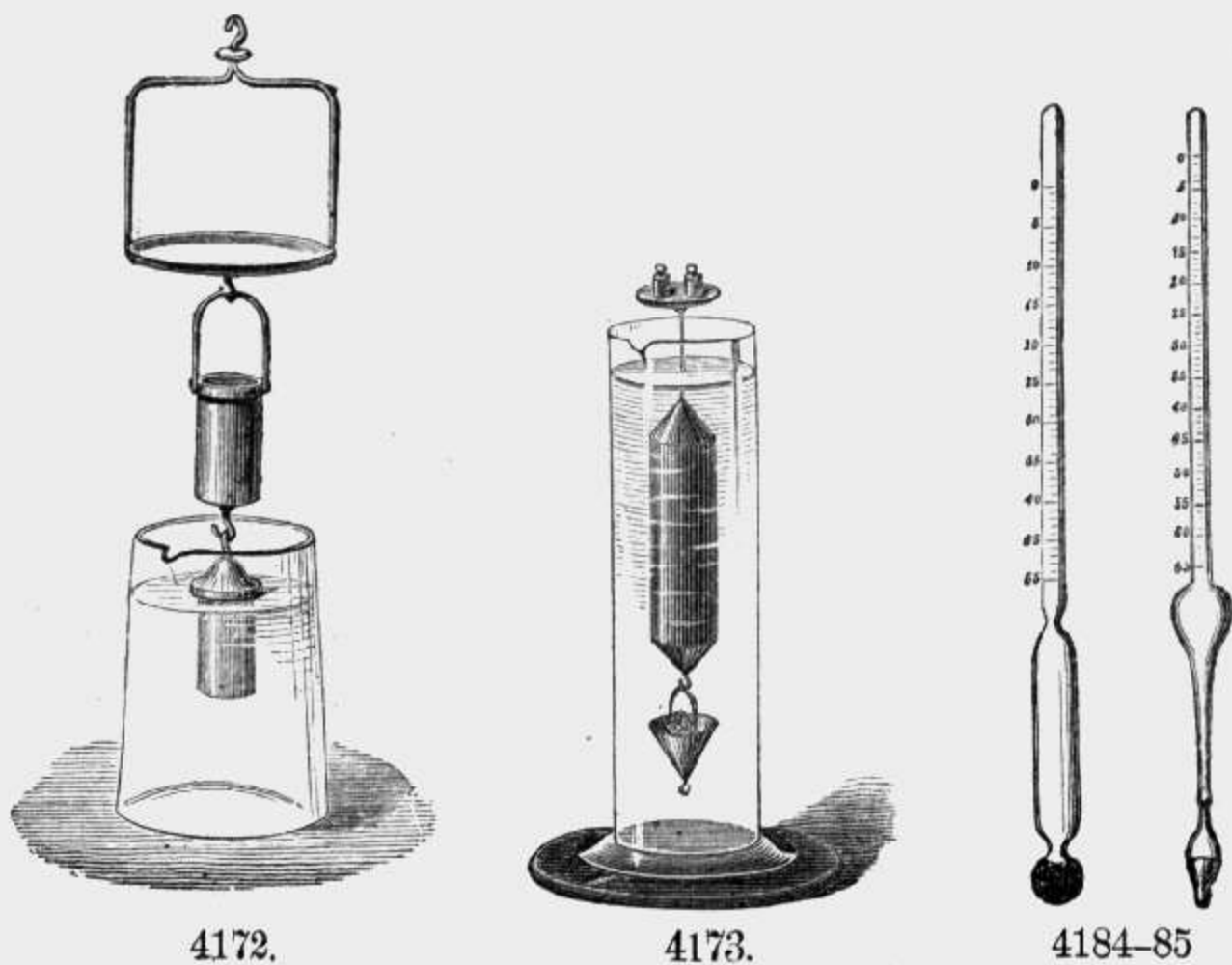

	PRICE
4172. <b>Archimedes Principle.</b> A brass bucket, with a solid piece of brass fitting it accurately within, and a glass tumbler.....	\$5 50
4173. <b>Nicholson's Balance.</b> Of brass, with glass water-jar.....	6 50
4174. <b>Nicholson's Balance.</b> Of brass, without water-jar.....	5 50
4180. <b>One Thousand Grain Bottle.</b> With perforated glass stopper and brass counterpoise, in neat tin case.....	
4181. <b>One Thousand Grain Bottle.</b> With mark on the neck, and brass counterpoise, but no stopper, packed in neat tin case.....	
4184. <b>Hydrometer.</b> For liquids lighter than water, from sp. gr. 1,000 to 700. In paper case.....	2 00
4185. <b>Hydrometer.</b> For liquids heavier than water, from sp. gr. 1,000 to 1,933. In paper case.....	2 00
4186. <b>Hydrometer Jar.</b> Plain, 15 inches high.....	1 00
4187. <b>Hydrometer Jar.</b> With lip, 15 inches high.....	1 25

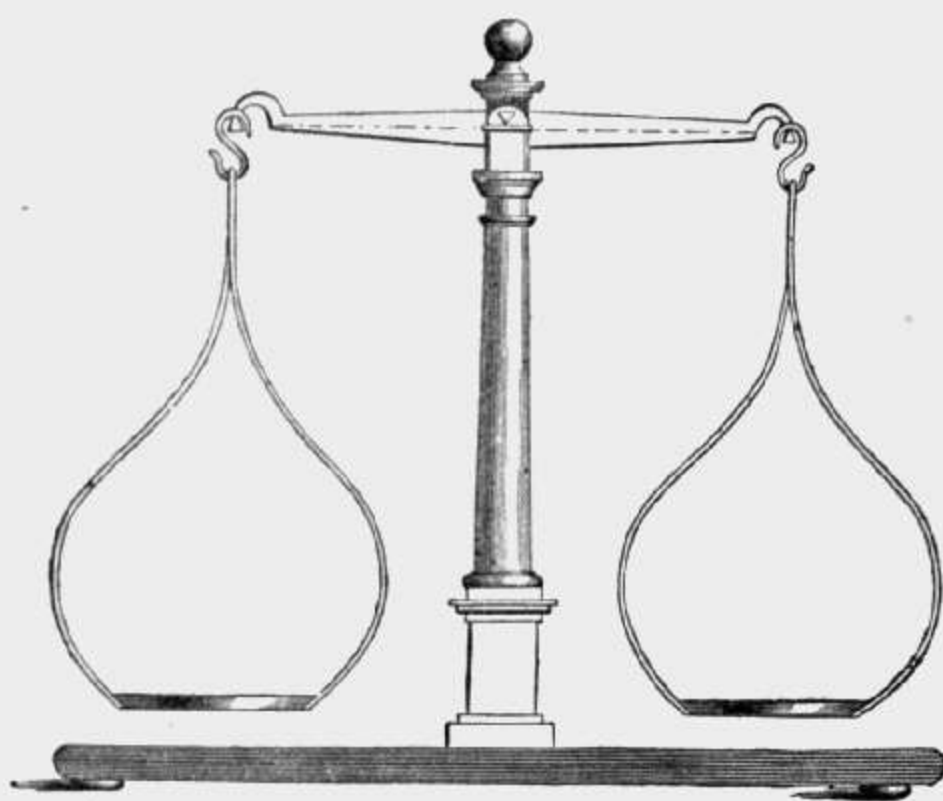

4190.

4190. **Balance for Specific Gravity,** and other purposes. Arm of brass, ten inches long, supported on knife edge. Pans of brass. Support of brass on wooden base..... 10 00

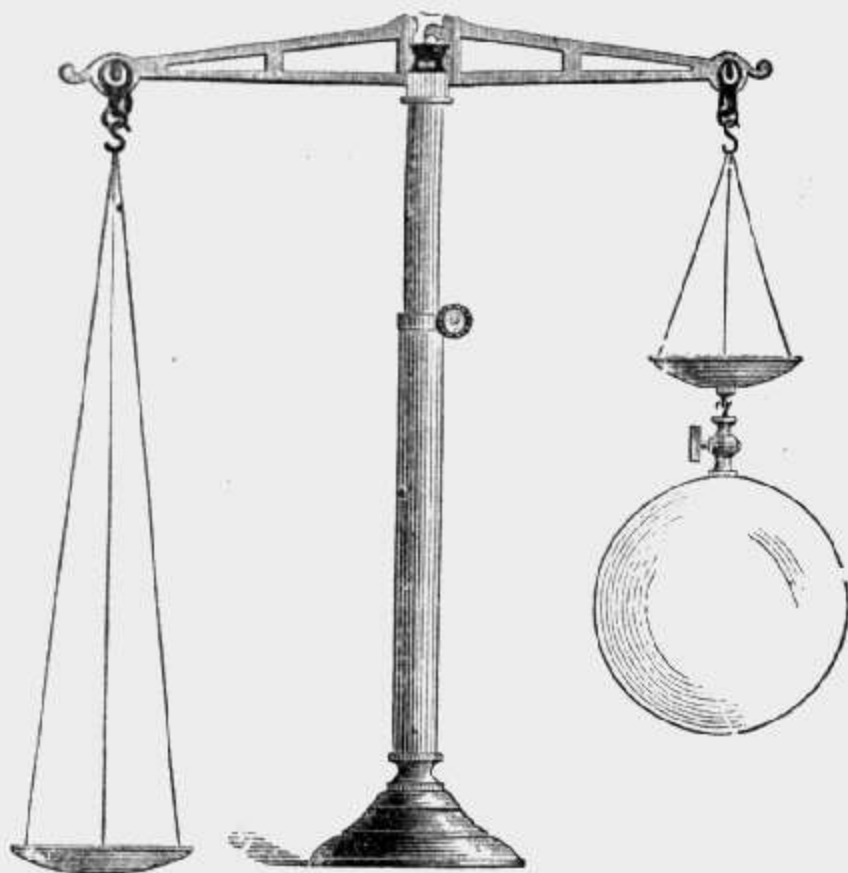

4191.

4191. **Specific Gravity Balance.** Fine brass beam, sixteen and a half inches long. Scale-pans of same material, with hook for various uses, suspended by a light brass chain. The beam and pans both swing on delicate knife edges. Mounted on polished brass elevating stand, which permits the knife edges to be raised twenty-three inches from the table. This instrument is very delicate, turning with a small fraction of a grain, and yet bearing a good load..... \$20 00

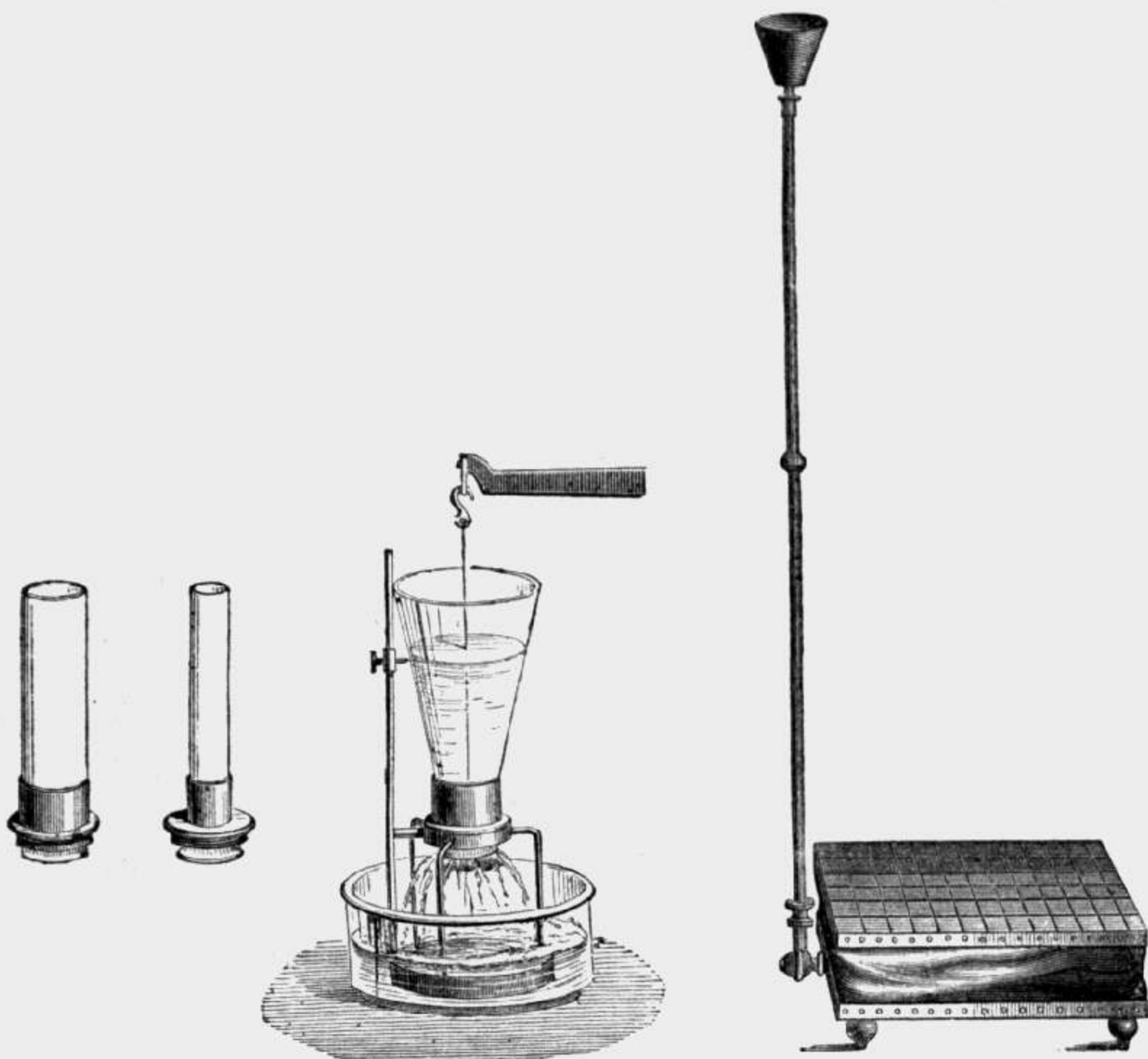

4192.

4193.

4192. **Pascal's Vases.** Three glass vessels of different sizes and shapes, with brass fittings. Tripod and index-holder of iron, brass disc, with silk cord, and glass tank for the water..... 25 00

4193. **Hydrostatic Bellows.** Bellows with mahogany top and base, leather sides, lined with rubber. Top 12 inches square. Brass and glass tubes, to contain the pressure column..... 25 00

4195. **Hydraulic Press.** Educational model. Small barrel,  $\frac{3}{4}$  inch in diameter; large barrel, four inches in diameter. Piston terminating in a wooden rod, which rises through the frame of polished cherry on which the press rests. By this instrument the exact pressure per square inch can be measured by connecting the instrument with a strong lever, so that the piston-rod can act as the power. A safety-gauge is attached..... 60 00



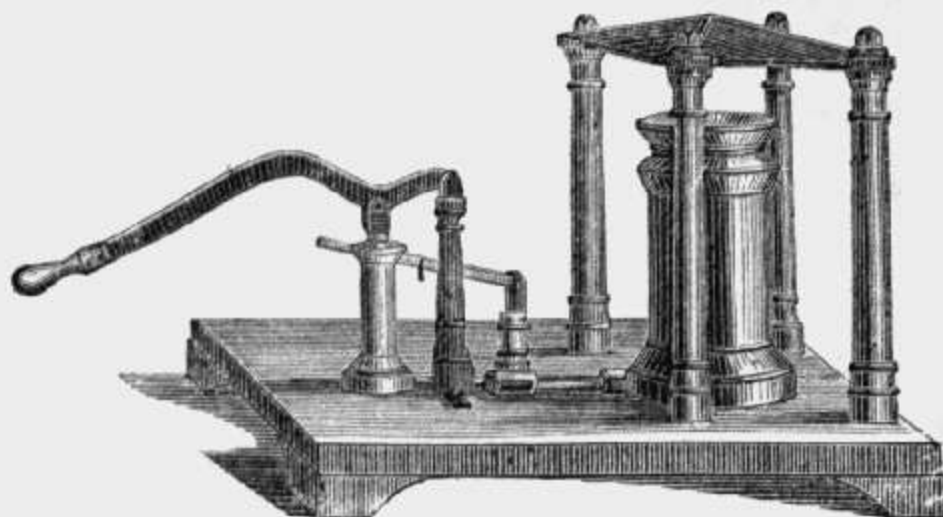

4196.

4196. **Hydraulic Press.** Working model. Same as No. 4195, but with posts of strong brass, top of frame and piston of wrought iron. All mounted on strong mahogany frame . . . . .

PRICE  
\$80 00

SECTION IV.—INSTRUMENTS EXEMPLIFYING THE PRINCIPLES OF EQUILIBRIUM.

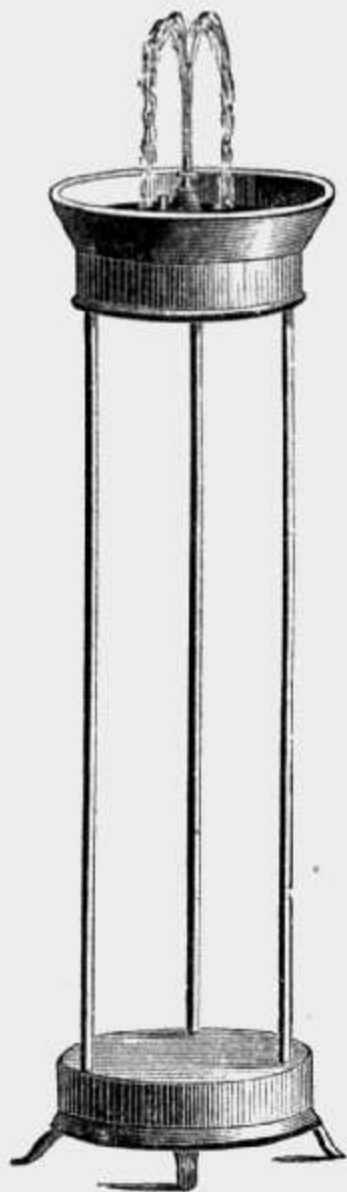

4200.

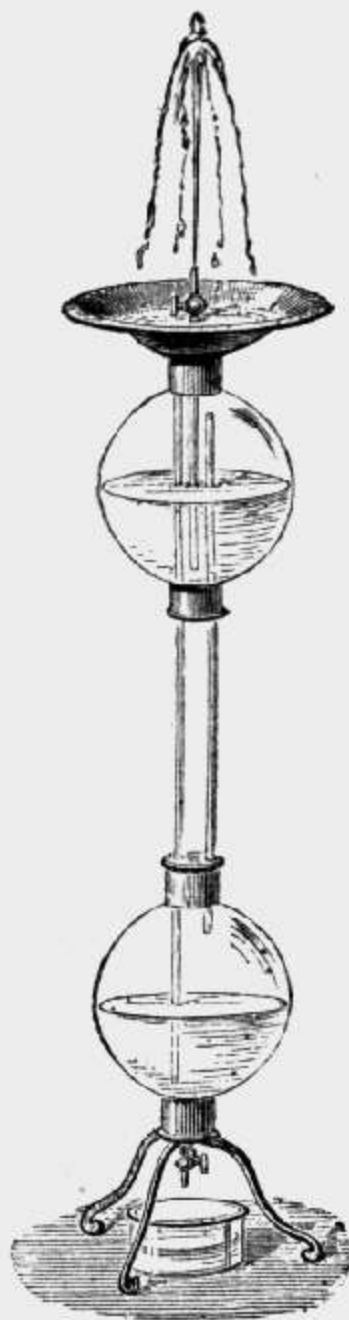

4201.

4200. **Hero's Fountain.** Cistern and vase of tin, tubes of brass. Thirty inches high . . . . .

10 00

4201. **Hero's Fountain.** Cisterns and vase of glass, and mountings of brass, finely finished. Thirty inches high . . . . .

20 00

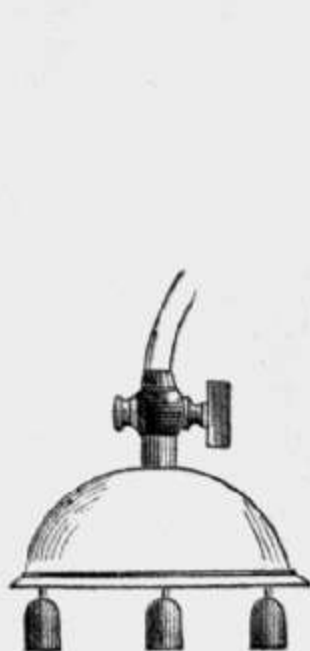

4203.



4204 and 4205.



4206 and 4207.

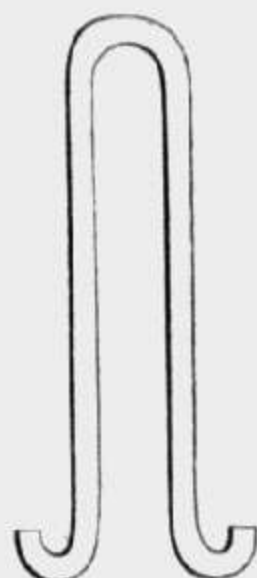

4208.

	PRICE
4202. <b>Diving Bell.</b> Glass model, six inches in diameter, with sinking weights of lead, and three feet of rubber hose.....	\$4 00
4203. <b>Diving Bell.</b> Glass model, six inches in diameter, with sinking weights of japanned iron, brass cap and stop-cock, with three feet of rubber hose .....	8 00
4204. <b>Plain Siphon.</b> Of glass tube ; long arm, twenty inches in length....	50
4205. <b>Plain Siphon.</b> Of brass tube, half inch in diameter ; long arm, twenty inches .....	1 00
4206. <b>Siphon with Suction Tube.</b> Of glass ; long arm, twenty inches.....	1 25
4207. <b>Siphon with Suction Tube.</b> Of brass ; long arm, fifteen inches.....	2 00
4208. <b>Wirtemberg Siphon,</b> Of glass tube, five-eighths of an inch diameter, arms each twenty inches long.....	1 00



4209.

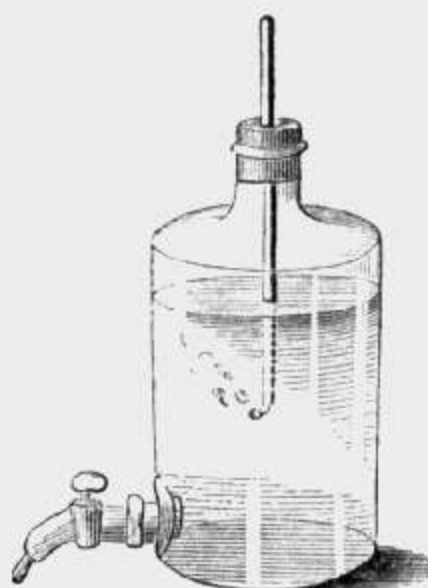

4211.

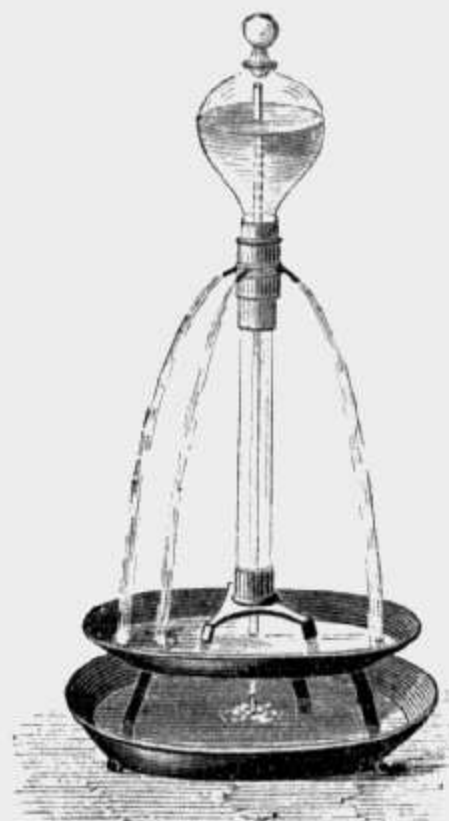

4212.

4209. <b>Tantalus Cup</b> .....	1 50
4210. <b>Mariotte's Vase.</b> Of glass, with rubber corks and glass tubes.....	3 00
4211. <b>Mariotte's Vase.</b> Of glass, with brass fittings.....	6 00
4212. <b>Intermittent Fountain,</b> Double basin of neatly japanned tin, inner one twelve inches in diameter, tubes and reservoir of glass, fittings of brass .....	12 50

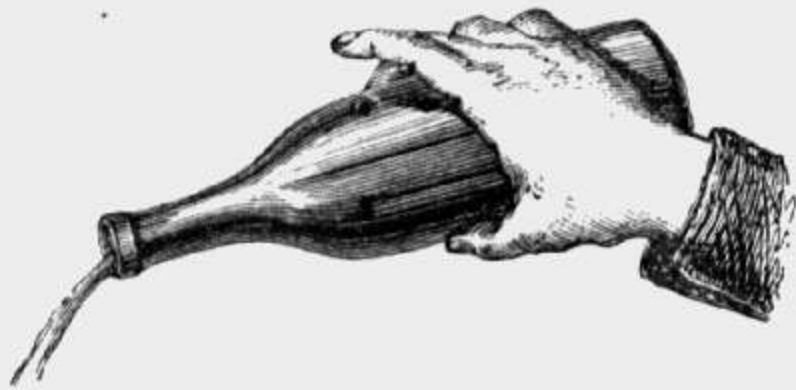

4216.



4217.

	PRICE
4215. <b>Magic Funnel.</b> Of tin, neatly japanned.....	\$1 00
4216. <b>Magic Bottle.</b> Of tin, neatly japanned. A bottle from which the experimenter may pour four different fluids at will, without refilling.	4 00
4217. <b>Magic Sieve.</b> Bottle of tin, neatly japanned, with bottom of fine wire gauze.....	2 00

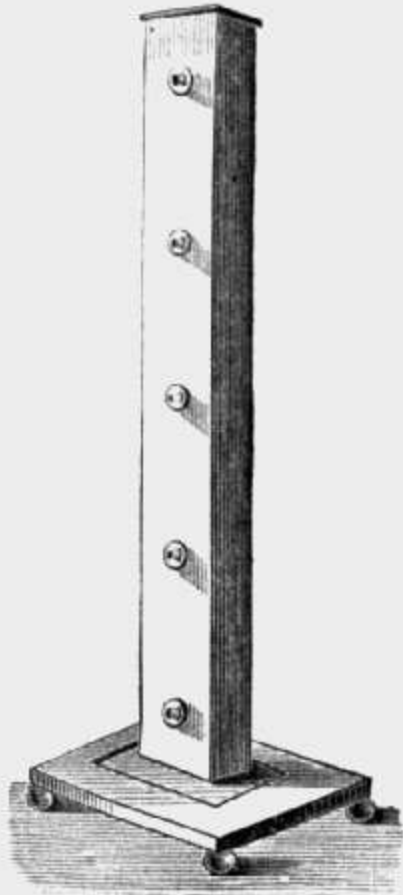

4220.

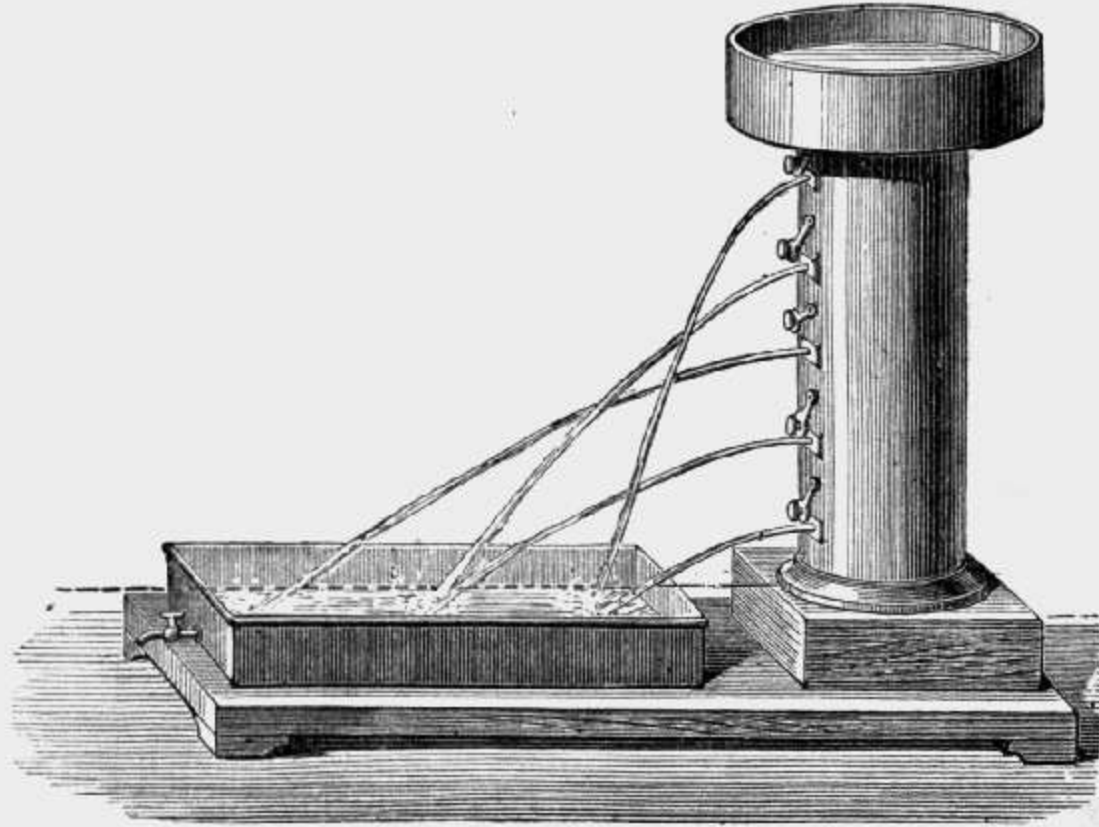

4221.

4220. <b>Vessel for Spouting Fluids.</b> Vertical cistern of tin, neatly japanned, twenty-eight inches high, with five apertures, closed with corks. Mounted on a neat mahogany base.....	7 50
4221. <b>Vessel for Spouting Fluids.</b> Vertical cistern of strong tin, neatly japanned, four inches in diameter, and two feet high, with supply tank on the top; five valves closing the jets at once; jets and valves both of improved form; tin trough with stop-cock, all mounted on a polished mahogany base.....	25 00



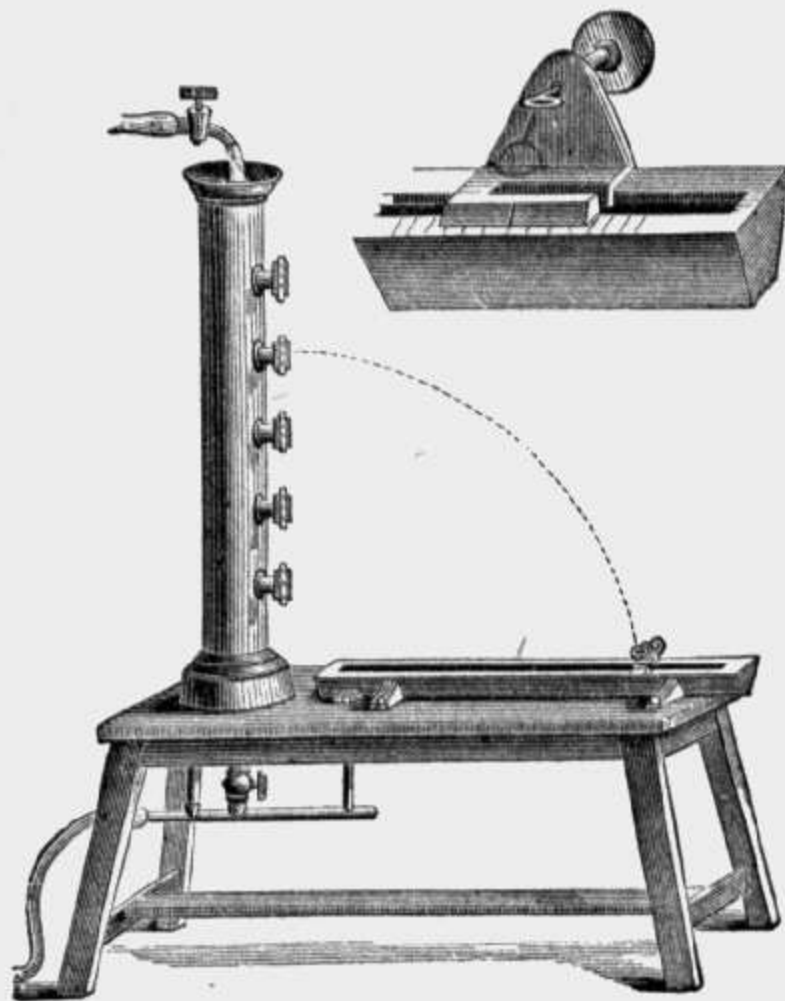

4222.

- |   |         |
|---|---------|
|   | PRICE   |
| 4222. <b>Vessel for Spouting Fluids.</b> Very superior and accurate, consisting of strong brass vertical cistern, three inches in diameter and thirty inches high ; valves communicating by a rod, so as to shut or open at once, and can also be used separately if desired. Jets in valves of three kinds, viz. : a thin circular, a tubular, and a conical form ; water trough of tin in a wooden frame, bearing a sliding rest with arm and hole to mark the exact point at which the water falls ; exit pipe from cistern and trough with stop-cocks and rubber hose ; all mounted on a neat, polished mahogany table..... | \$60 00 |

SECTION V.—ON THE APPLICATION OF THE PRINCIPLES OF GRAVITATION TO MACHINERY.

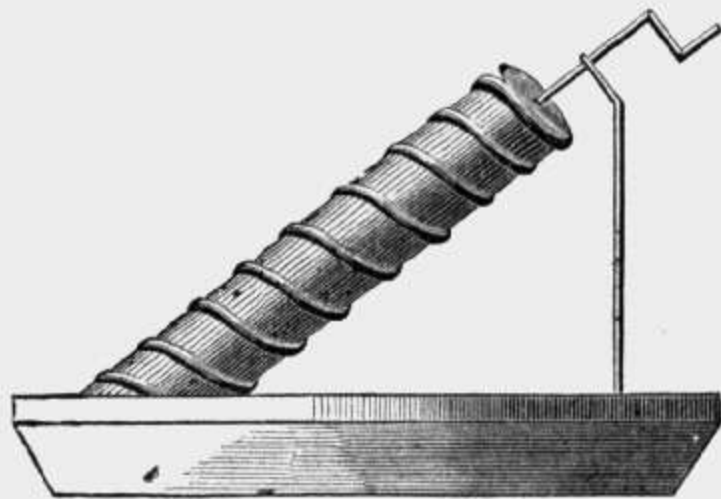

4230.

- |   |       |
|---|-------|
| 4230. <b>Archimedes Pump.</b> Vessel of japanned tin, with screw of lead pipe, on a cylinder of wood twelve inches long.....  | 5 00  |
| 4231. <b>Archimedes Pump.</b> Base of mahogany, cistern of heavy tin, neatly japanned ; screw of glass tube, supported on metal rods fifteen inches long. Post of brass ..... | 12 00 |

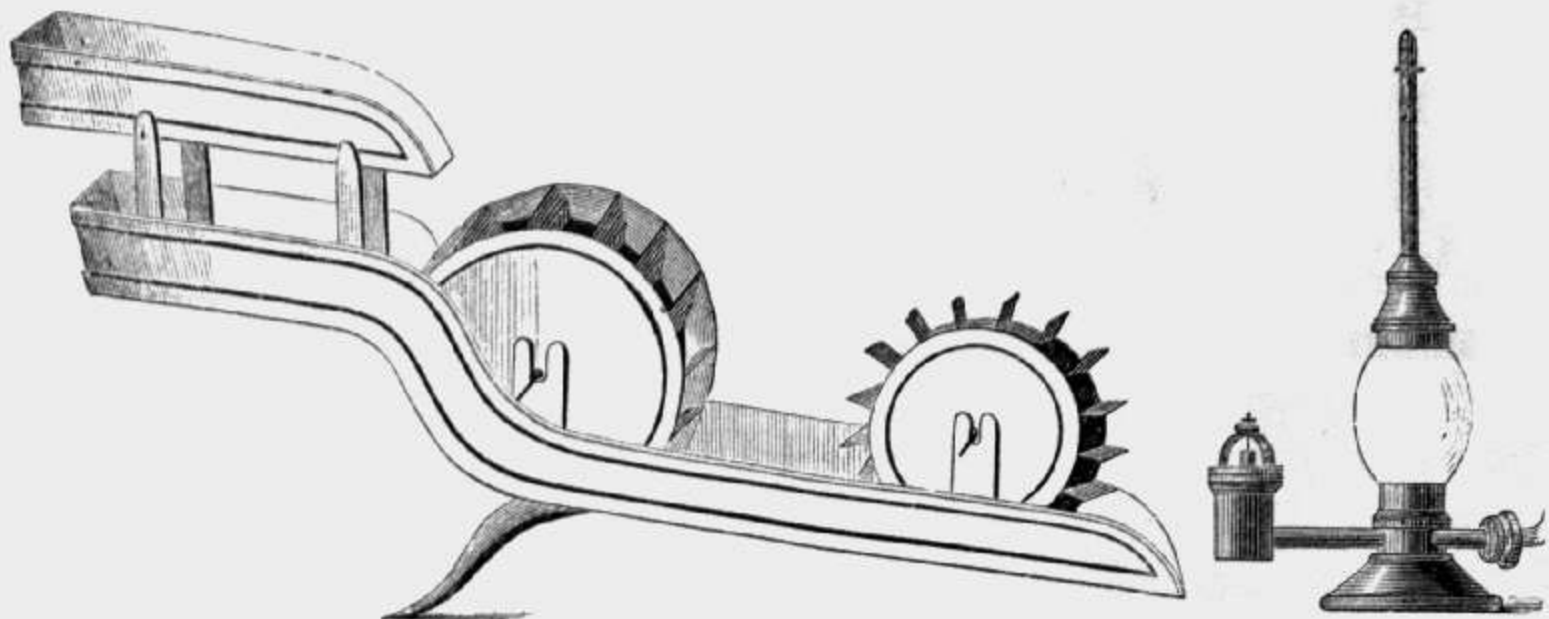

4232.

4233.

- |  | PRICE  |
|--|--------|
| 4232. <b>Model of Water Wheels.</b> Three feet long ; undershot, overshoot, and breast wheel, on same stand. The overshoot serves for breast wheel by reversing. All made of heavy tin neatly japanned . . . . .                             | \$9 00 |
| 4233. <b>Hydraulic Ram.</b> Small model of brass, with glass chamber and pipe for throwing a vertical fountain. The supply pipe is coiled around the ascending jet, and the whole, when in action, resembles a self-acting fountain. . . . . | 14 00  |

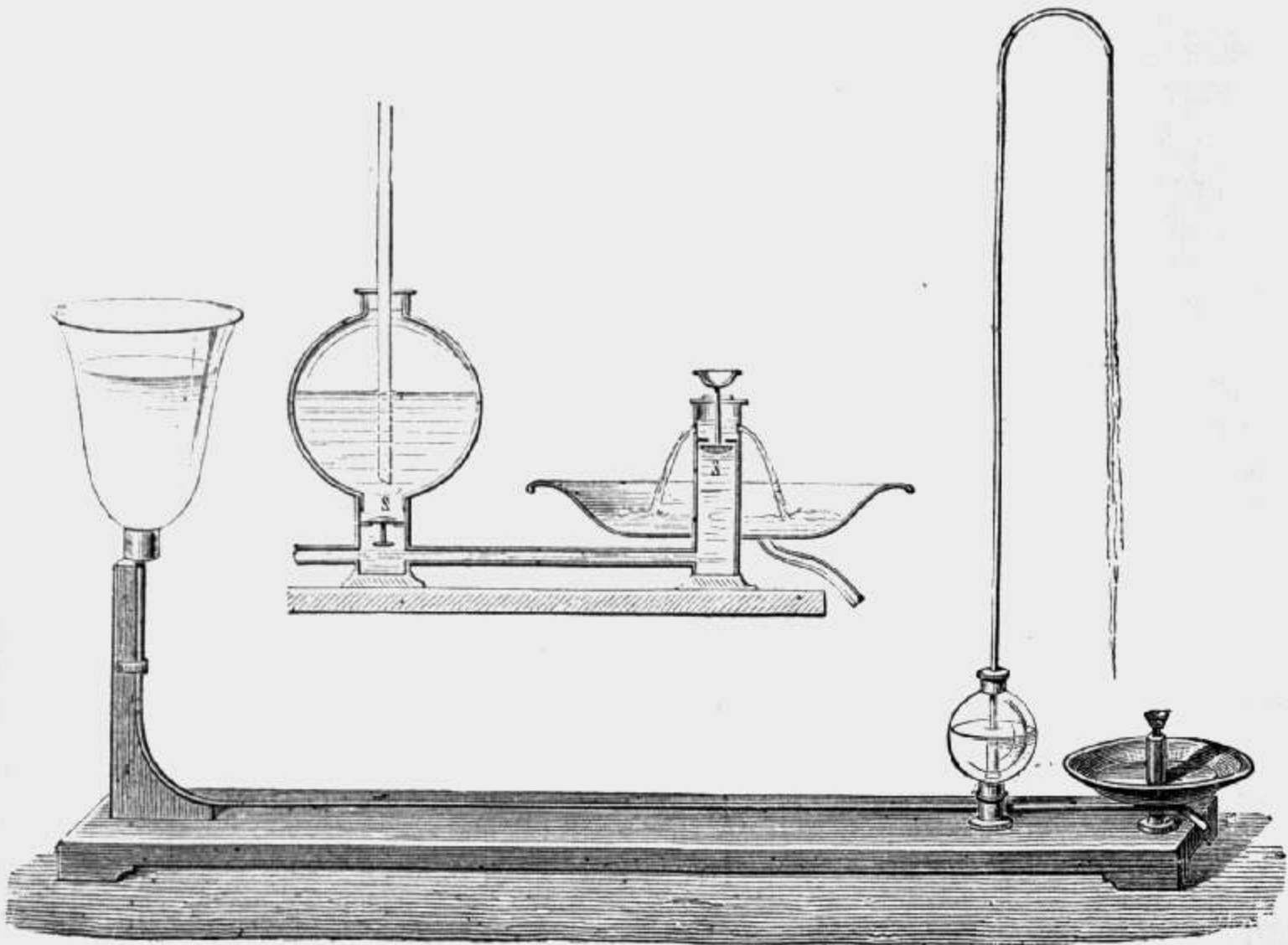

4234.

4234. **Hydraulic Ram.** Reservoir of glass, connected by means of a brass pipe with the ram proper, which has a glass chamber or condenser, and overflow basin, with exit tube and stop-cock. A long vertical tube of glass, bent as shown in the figure, allows the rising of the fluid to be clearly seen. Base of polished mahogany, three and one-half feet long. . . . . 25 00

	PRICE
4235. <b>Barker's Mill.</b> Model fifteen inches high, wooden sides, tin water-pan, arms and upright tube of brass.....	\$8 00
4236. <b>Barker's Mill.</b> Of glass, with brass fittings, as shown in cut. Twenty-four inches high.....	6 00
4237. <b>Turbine Wheel.</b> Small working model, of neatly japanned tin, with brass finish and gearings; with basin for outflow. Whole instrument twenty inches high.....	25 00

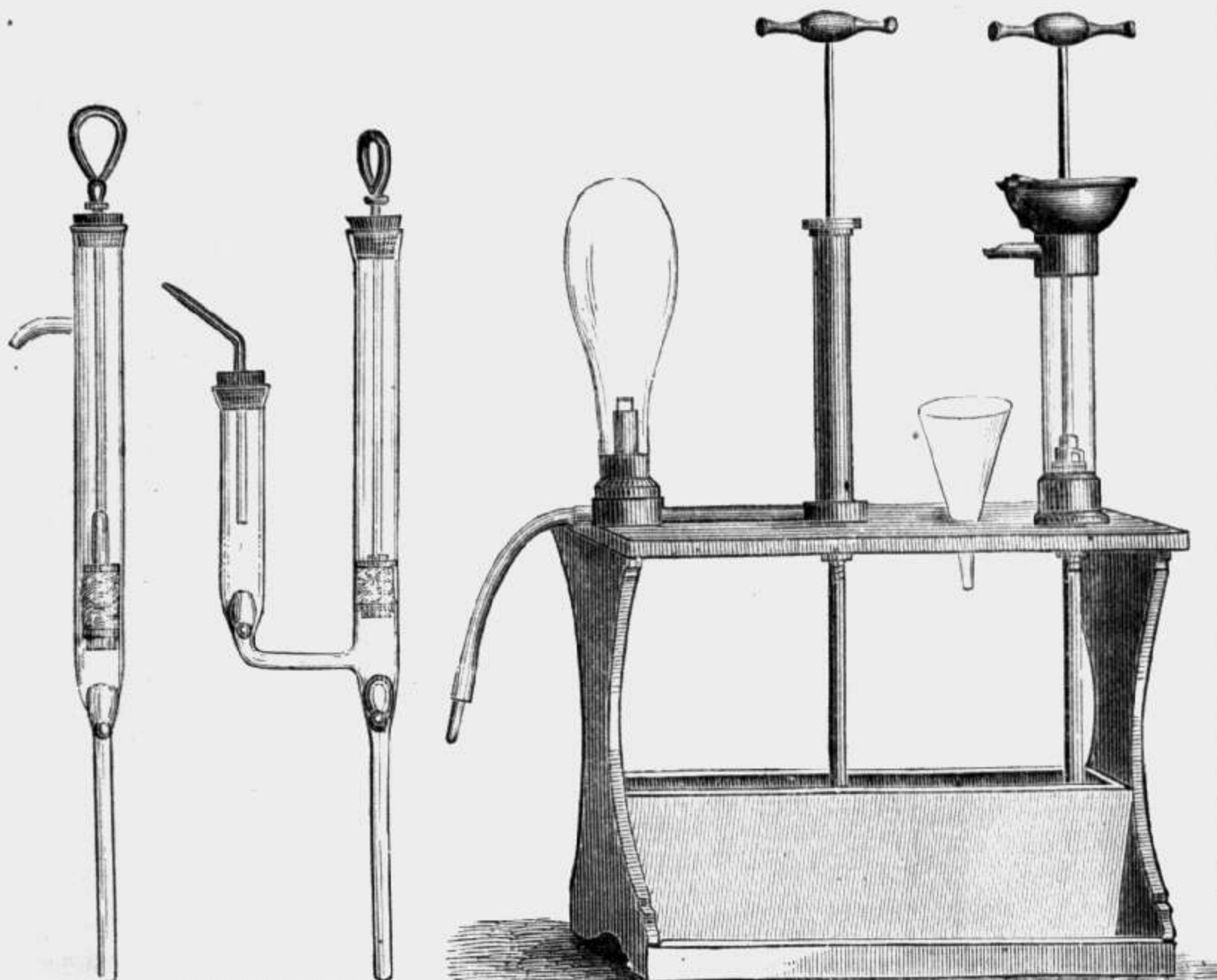

CROSSCUP&WEST, PHILA.

4238.

4239.

4242.

4238. <b>Lifting Pump.</b> Working model, fifteen inches high; all of glass, with conical valves.....	3 00
4239. <b>Forcing Pump.</b> Working model, fifteen inches high; all of glass, with conical valves.....	3 00
4240. <b>Lifting Pump.</b> Working model, barrel of glass, with brass fittings. Valves in the piston, and in the body of the pump, both easily seen. Mounted on a neat mahogany stand, with glass water-jar. Whole instrument twenty inches high.....	10 00
4241. <b>Forcing Pump.</b> Working model, barrel of brass, condensing chamber of strong glass, with brass fittings. Exit-tube of rubber, with a brass tip. Mounted on a neat mahogany stand, with glass water-jar. Whole instrument twenty inches high.....	14 00
4242. <b>Lifting and Forcing Pumps.</b> Nos. 4240 and 4241 on the same stand, of polished mahogany; with water-pan of tin, neatly japanned.....	22 50



SECTION VI.—THE BAROMETER AND THE AIR-PUMP.



4249.

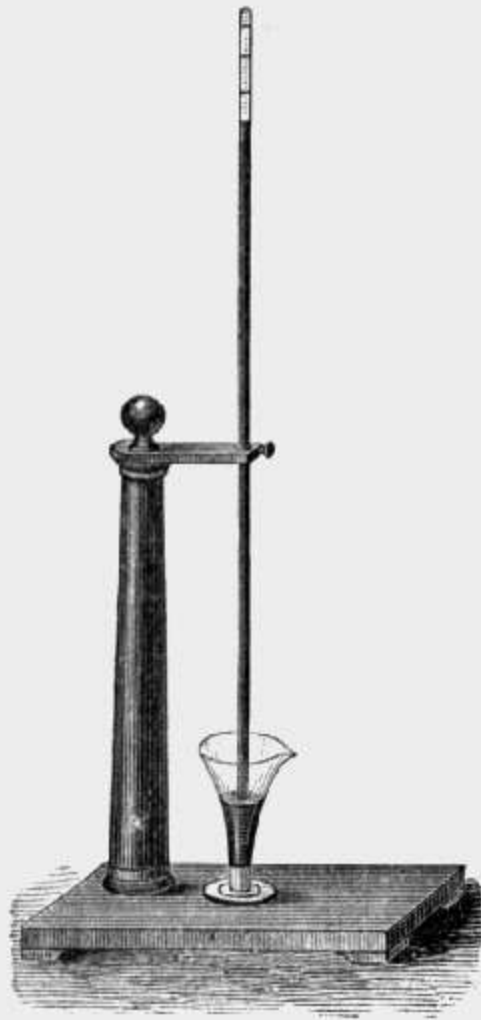

4251.

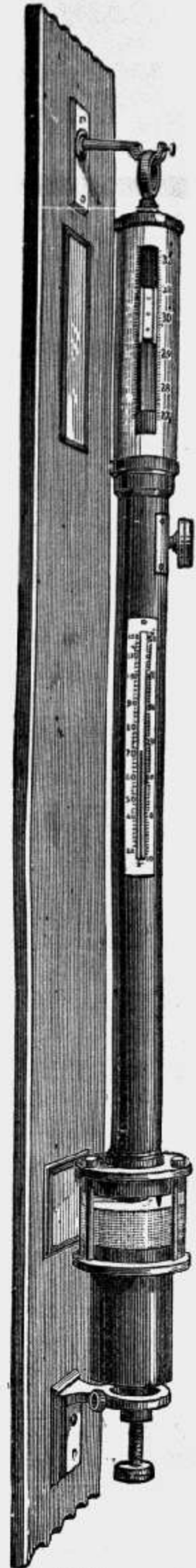

4253.

- |  | PRICE  |
|--|--------|
| 4249. <b>Barometer Tube.</b> Thirty-five inches long.....  | \$0 75 |
| 4250. <b>Barometer Tube.</b> Of heavy glass, thirty-five inches long, with glass cup for mercury.....  | 1 25   |
| 4251. <b>Barometer Tube.</b> Same as No. 4250, but with supporting table and pillar of mahogany, and arm of brass to hold the tube.....  | 5 00   |
| 4252. <b>Barometer Tube.</b> Of heavy glass, thirty-five inches long, open at both ends. When used, to have one end closed with sheet rubber.....  | 0      |
| 4253. <b>Normal or Standard Barometer.</b> The construction of this instrument is on that principle known as Fortin's, in which the mercury in the cistern is adjusted at each observation to a fixed ivory point, the zero of the scale. The tube is half an inch in interior diameter. The cistern is made partly of glass, showing the ivory point, or zero, to which the mercury in the cistern is adjusted at each observation by means of the thumb-screw shown at the base of the figure. The vernier reads to the 500th part of an inch, and is adjusted by a rack and pinion. A delicate thermometer is attached in the front of the barometer, and shielded from injury by the brass casing. The whole instrument is finished with brass and mounted upon a solid mahogany frame, as shown in the cut..... | 85 00  |

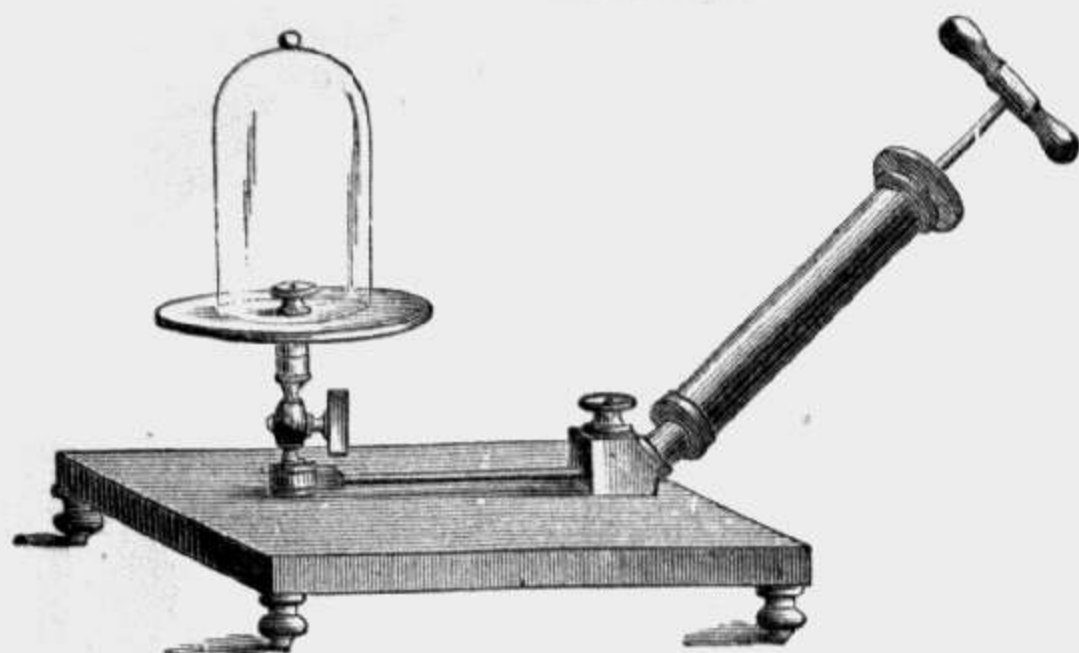

4260.

- |  | PRICE   |
|--|---------|
| 4259. <b>Air-Pump.</b> Barrel of brass, seven inches long by one and a quarter inches in diameter. Plate of brass, six inches in diameter; with guard-screw, and quart bell-glass receiver, No. 4277.....              | \$20 00 |
| 4260. <b>Air-Pump.</b> Barrel of brass, seven inches long by one and a quarter inches in diameter. Plate of brass, eight inches in diameter; with guard-screw, stop-cock, and quart bell-glass receiver, No. 4277..... | 25 00   |

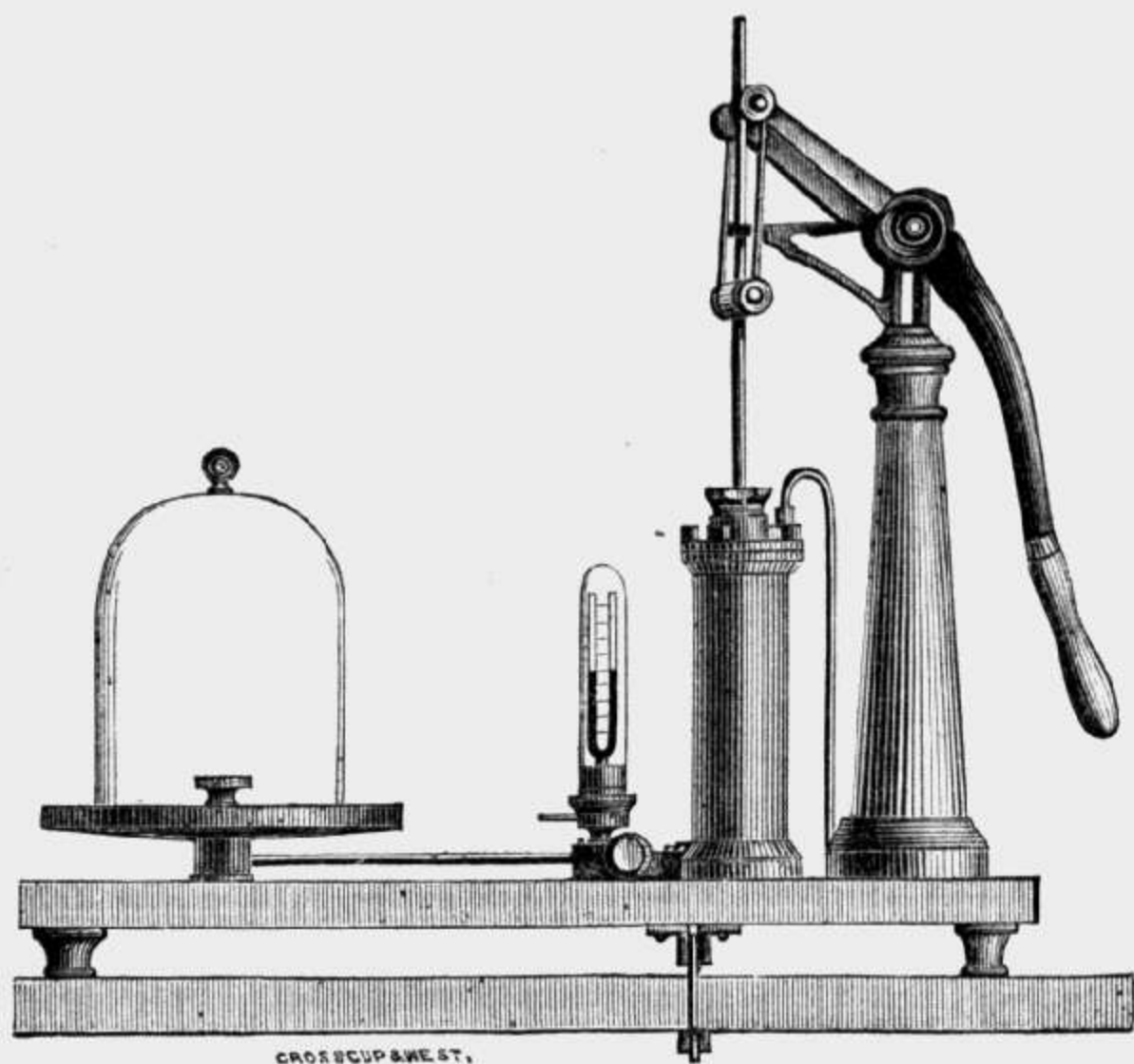

CROSSCUP & WEST,

4262.

- |   |       |
|---|-------|
| 4261. <b>Lever Air-Pump.</b> Barrel of brass, seven and a half inches long, and two inches in diameter. Plate of brass, eight inches in diameter; with guard-screw, stop-cock, and half-gallon bell-glass receiver, No. 4278. Base and pillar of polished walnut. Strong iron clamp to fasten the whole instrument securely to a table..... | 50 00 |
| 4262. <b>Lever Air-Pump.</b> Same as No. 4261, but with the addition of a siphon gauge.....   | 55 00 |

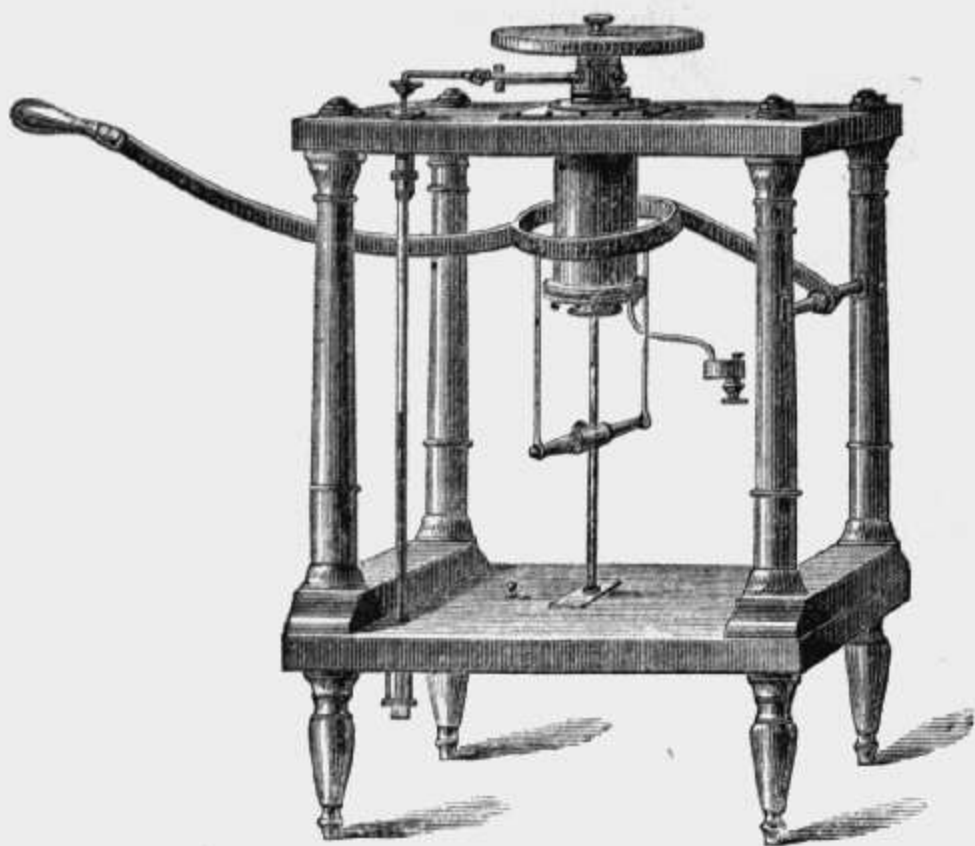

4264.

4264. **Lever Air-Pump.** Frame of solid mahogany, finely polished, forty inches high. Barrel of brass, twelve inches long by four inches in diameter. Plate of brass, fourteen inches in diameter; with guard-screw, stop-cock, and a two-gallon bell-glass receiver; No. 4280... \$200 00

PRICE

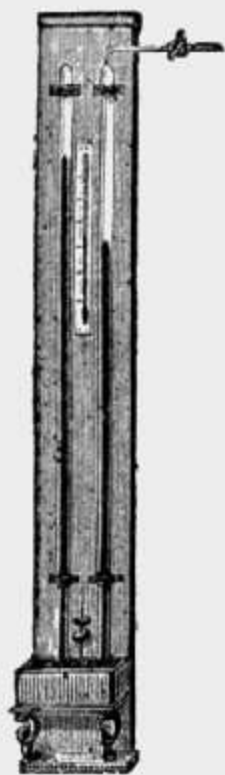

4270.



4272.

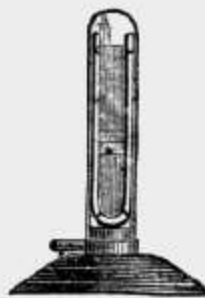

4273.

4270. **Barometric Manometer.** An upright mahogany frame, supporting a cistern of iron and an open and a closed barometer tube. The former is furnished with a stop-cock, and should be connected with the vacuum chamber of the air-pump. The latter is an ordinary barometer tube. By means of this instrument the exact degree of rarefaction can be determined by the comparison afforded by the two barometers. . . . . 12 50
4271. **Barometer Gauge.** Enclosed in a strong glass tube, with brass cap and stop-cock at the upper end to permit the exhaustion of the air from the outer tube, thus allowing the barometer column to fall as the exhaustion proceeds. On a neat mahogany stand. . . . . 30 00



	PRICE
4272. <b>Siphon Gauge.</b> Of glass, six inches long, mounted on a graduated metallic frame, with screw to fit the plate of the air-pump. For use under a receiver. . . . .	\$3 00
4273. <b>Siphon Gauge.</b> Of glass, six inches long, mounted on a graduated brass frame, the whole upon a neat stand, and covered air-tight, with a bell-glass. A pipe at one side permits an attachment to the pump by means of a rubber hose. . . . .	6 00
4275. <b>Detached Pump Plate</b> of brass, fourteen inches in diameter, mounted on a solid support of cast iron; with stop-cock and screw connection for rubber hose. . . . .	25 00

BELL-GLASSES.

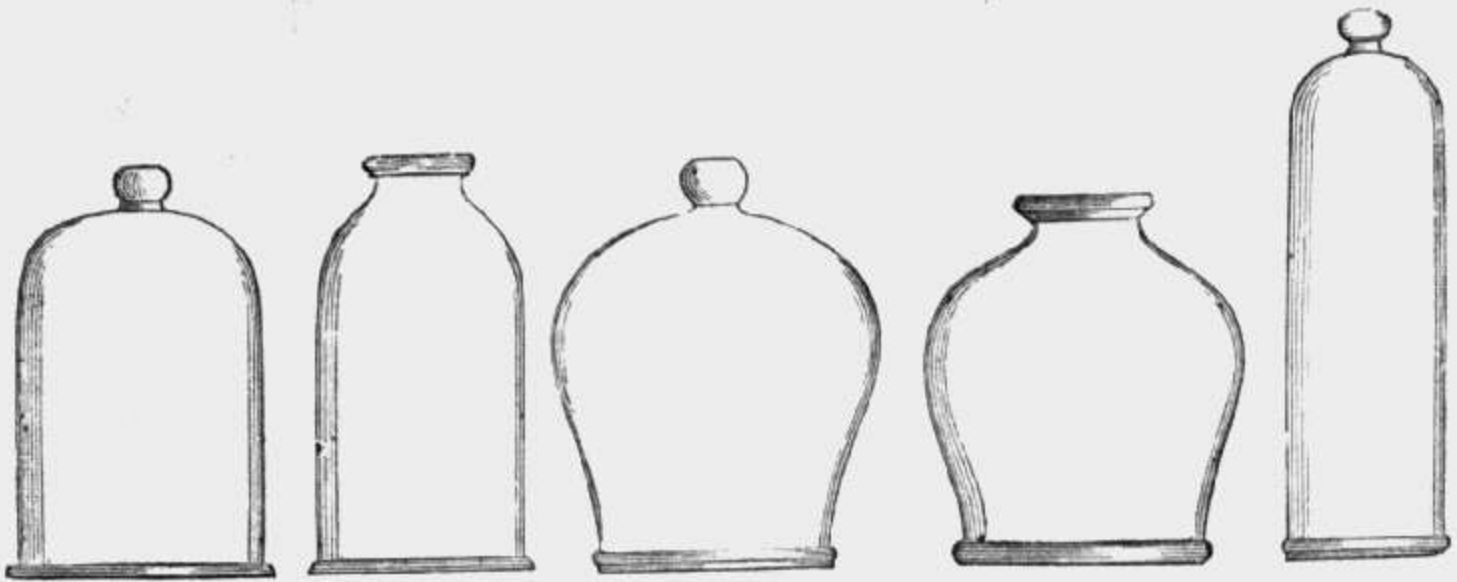

4276-80.      4281-84.      4285-88.      4289-92.      4293 and 4294.

4276. <b>Plain pint bell-glass,</b> with ground flange. . . . .	0 75
4277. <b>Plain quart bell-glass,</b> " " . . . . .	1 00
4278. <b>Plain half-gallon bell-glass,</b> with ground flange. . . . .	1 50
4279. <b>Plain gallon bell-glass,</b> " " . . . . .	2 00
4280. <b>Plain two-gallon bell-glass,</b> " " . . . . .	3 75
4281. <b>Open top, quart, plain bell-glass,</b> " " . . . . .	1 25
4282. <b>Open top, half-gallon, plain bell-glass,</b> " " . . . . .	1 50
4283. <b>Open top, gallon, plain bell-glass,</b> " " . . . . .	2 50
4284. <b>Open top, two-gallon, plain bell-glass,</b> " " . . . . .	4 00
4285. <b>Swelled, quart bell-glass,</b> " " . . . . .	1 00
4286. <b>Swelled, half-gallon bell-glass,</b> " " . . . . .	2 00
4287. <b>Swelled, gallon bell-glass,</b> " " . . . . .	2 75
4288. <b>Swelled, two-gallon bell-glass,</b> " " . . . . .	3 50
4289. <b>Swelled, open top, quart bell-glass,</b> " " . . . . .	1 25
4290. <b>Swelled, open top, half-gallon bell-glass,</b> " " . . . . .	2 25
4291. <b>Swelled, open top, gallon bell-glass,</b> " " . . . . .	3 00
4292. <b>Swelled, open top, two-gallon bell-glass,</b> " " . . . . .	4 00
4293. <b>Plain bell-glass,</b> six inches in diameter and fifteen inches high, with ground flange. . . . .	3 50
4294. <b>Plain bell-glass,</b> six inches in diameter and thirty-four inches high, with ground flange. . . . .	8 00
4295. <b>Ground-glass cover,</b> four inches in diameter, for any of the open top bell-glasses . . . . .	80

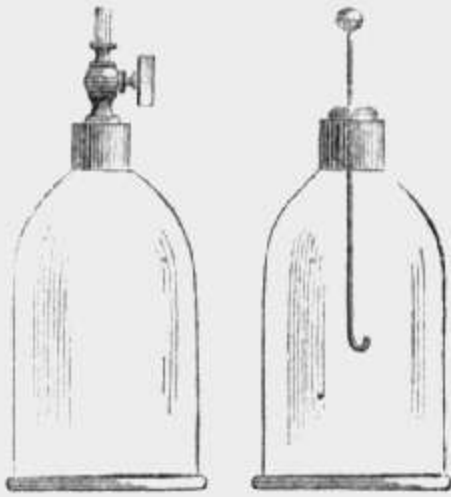

4296. 4297.

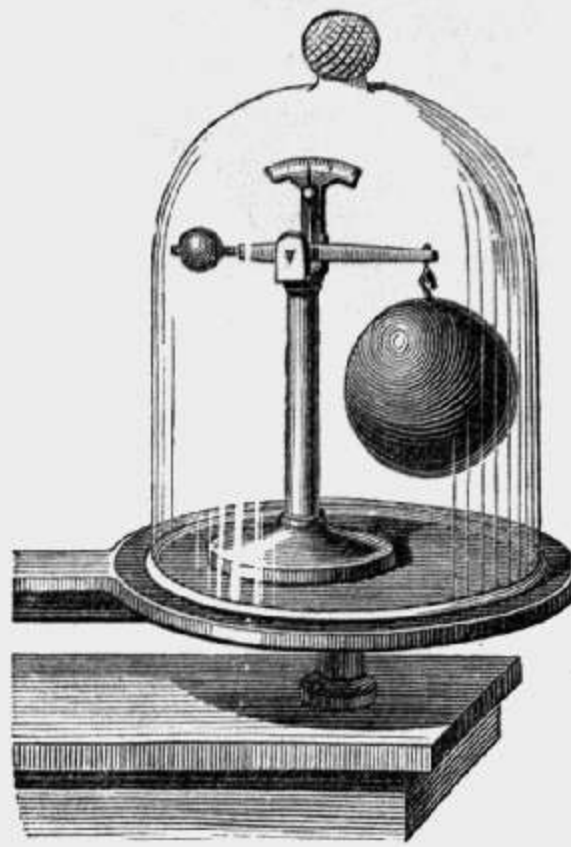

4298.

	PRICE
4296. Plain gallon bell-glass, with brass cap and stop-cock.....	\$4 50
4297. Plain gallon bell-glass, with brass sliding rod, hook and ball.....	4 50
4298. Hollow Copper Globe. Three inches in diameter, with stop-cock and scale-beam for suspension under receiver, with box and weights. Without the receiver.....	12 50
4299. Hollow Copper Globe. For weighing air, 7 inches in diameter, with stop-cock and hook.....	5 50
4300. Cork Globe. Three inches in diameter, with scale-beam and counterpoise.....	5 50
4301. Accurate Balance. For weighing air, and for specific gravity purposes. Beam of brass, sixteen and a half inches long, scale pans and beam both moving on knife-edges, and supporting post permitting a vertical adjustment.....	20 00



4310.

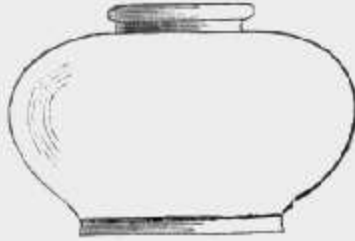

4311.



4312-4316.

4310. Hand Glass.....	1 25
4311. Bladder Glass.....	1 25
4312. Magdeburg Hemispheres. Of brass, three inches in diameter, on stand of iron, neatly japanned.....	8 00
4313. Magdeburg Hemispheres. Same as No. 4312, but three and a half inches in diameter.....	9 00
4314. Magdeburg Hemispheres. Same as No. 4312, but four inches in diameter.....	10 00
4315. Magdeburg Hemispheres. Of cast iron, four inches in diameter, on iron stand. All neatly japanned.....	7 50
4316. Magdeburg Hemispheres. Same as No. 4315, but five inches in diameter.....	13 50

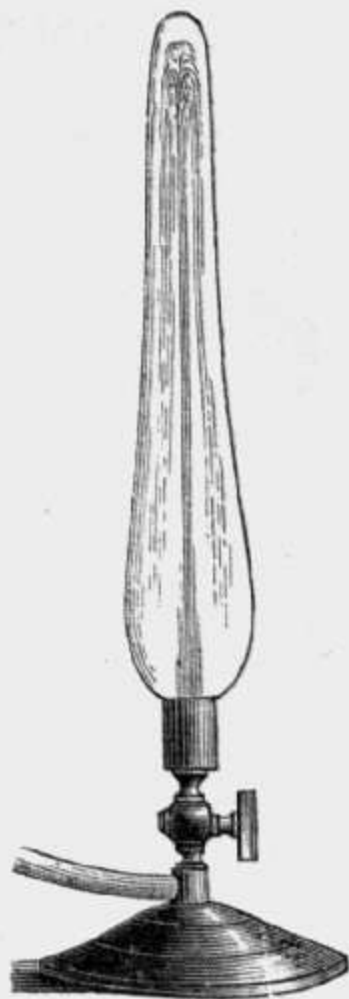

4320 and 4321.

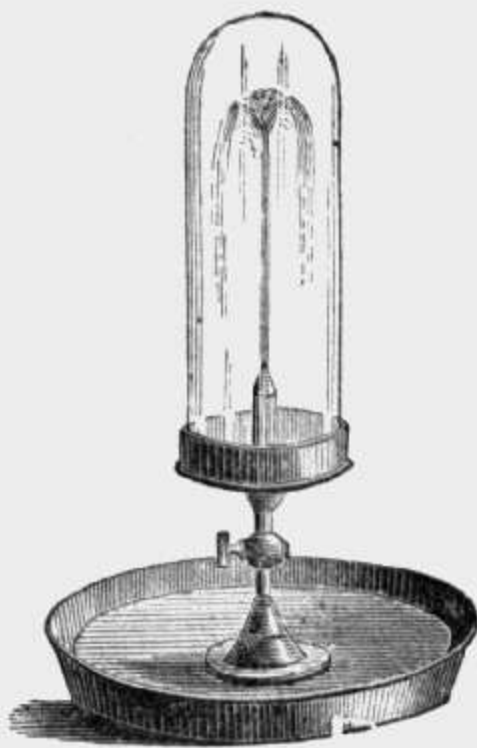

4322 and 4323.



4324.

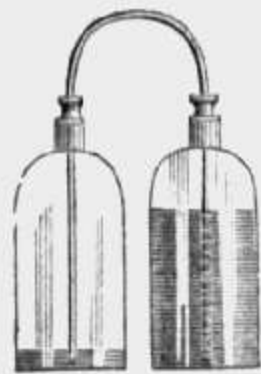

4325.

PRICE

- |  |        |
|--|--------|
| 4320. Fountain in Vacuo. Glass bell, twenty inches high, with brass fitting and stop-cock, on a neatly japanned iron base..... | \$7 00 |
| 4321. Fountain in Vacuo. Same as No. 4320, but with glass bell, twenty-six inches high.....                                    | 8 00   |

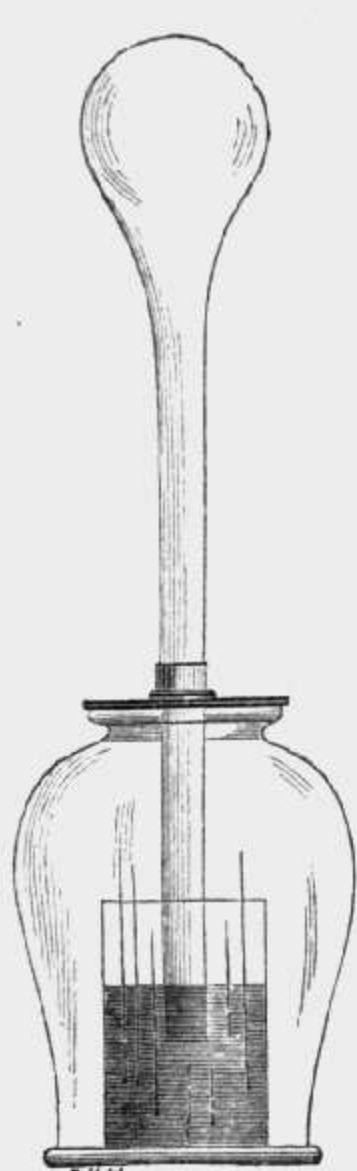

4331.

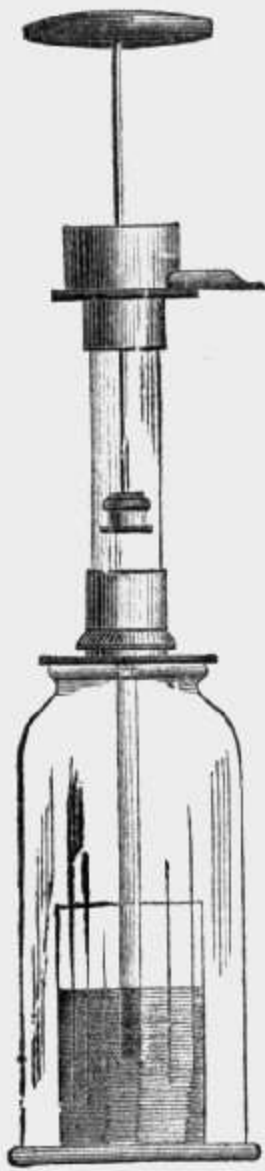

4333.



4335.

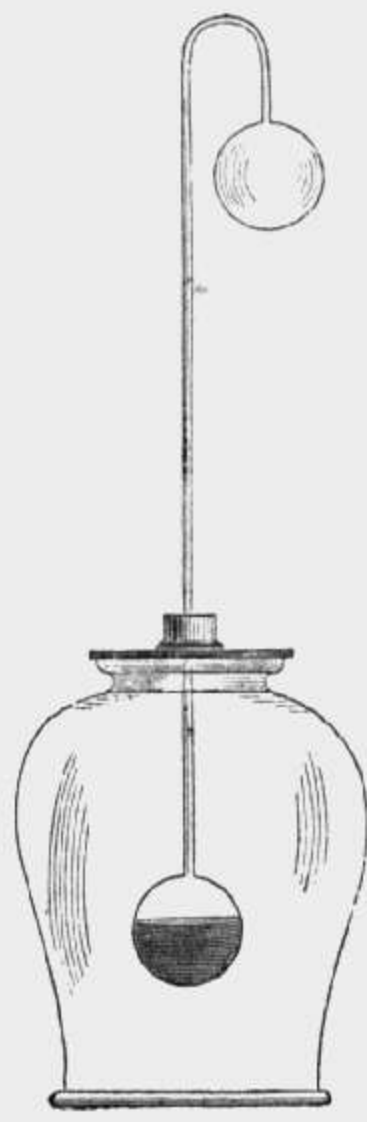

4337.



	PRICE
4322. <b>Fountain in Vacuo.</b> French form, in which the base is ground to fit the pump plate, glass bell 24 inches high and four inches in diameter. Brass cap, stop-cock, and base, and water cistern of japanned tin.....	\$12 00
4323. <b>Fountain in Vacuo.</b> Same as No. 4322, but with glass bell, 30 inches high.....	15 00
4324. <b>Expansion Fountain.</b> Twelve inches high.....	5 00
4325. <b>Bacchus Illustration.</b> Glass vessels seven inches high, with brass fittings.....	3 00
4330. <b>Bolt Head.</b> Thirty inches long, with brass cap for receiver, without receiver or glass cell.....	4 00
4331. <b>Bolt Head,</b> same as No. 4330, but with receiver No. 4291, and glass cell as shown in cut.....	7 50
4332. <b>Water Pump in Vacuo.</b> Glass working model with brass mountings, and ground brass cap for receiver, without receiver or glass cell....	10 00
4333. <b>Water Pump in Vacuo.</b> Same as No. 4332, but with receiver, No. 4283, and glass cell, complete.....	13 00
4334. <b>Barometer Tube in Vacuo.</b> Strong barometer tube, with ground brass flange for receiver, without receiver or glass cell.....	4 50
4335. <b>Barometer Tube in Vacuo.</b> Same as No. 4334, but with receiver No. 4283, and glass cell complete.....	7 50
4336. <b>Cryophorus in Vacuo.</b> With ground brass flange for receiver, without receiver.....	4 50
4337. <b>Cryophorus in Vacuo.</b> Same as No. 4336, but with receiver No. 4291.....	7 50



4340.



4341.

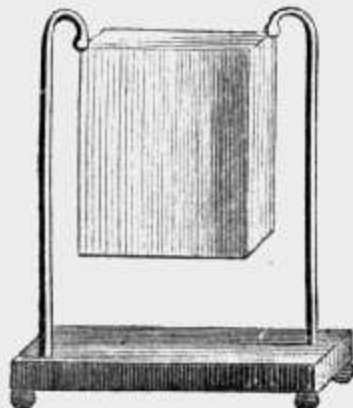

4342.

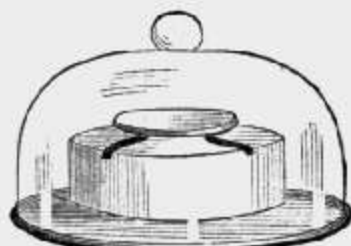

4343 and 4344.



4350.

4340. <b>Bell for Vacuum.</b> Support of brass. Cords of silk.....	4 00
4341. <b>Bell for Vacuum.</b> Spring bell, neatly silvered, resting on a support of rubber.....	4 00
4342. <b>Bell for Vacuum.</b> Furnished with clock movement for striking the bell, and thoroughly insulated by cords of silk and base of rubber, so as to convey the least possible sound to the pump plate.....	20 00
4343. <b>Freezing Apparatus.</b> Glass dish six inches in diameter, wire support for watch glass, and shallow receiver to suit.....	2 50
4344. <b>Freezing Apparatus.</b> Similar to No. 4343, but with eight-inch dish and receiver.....	3 00
4350. <b>Apparatus for firing Powder in a Vacuum.</b> Brass funnel, drop stop-cock, and ground brass flange four inches in diameter.....	6 00

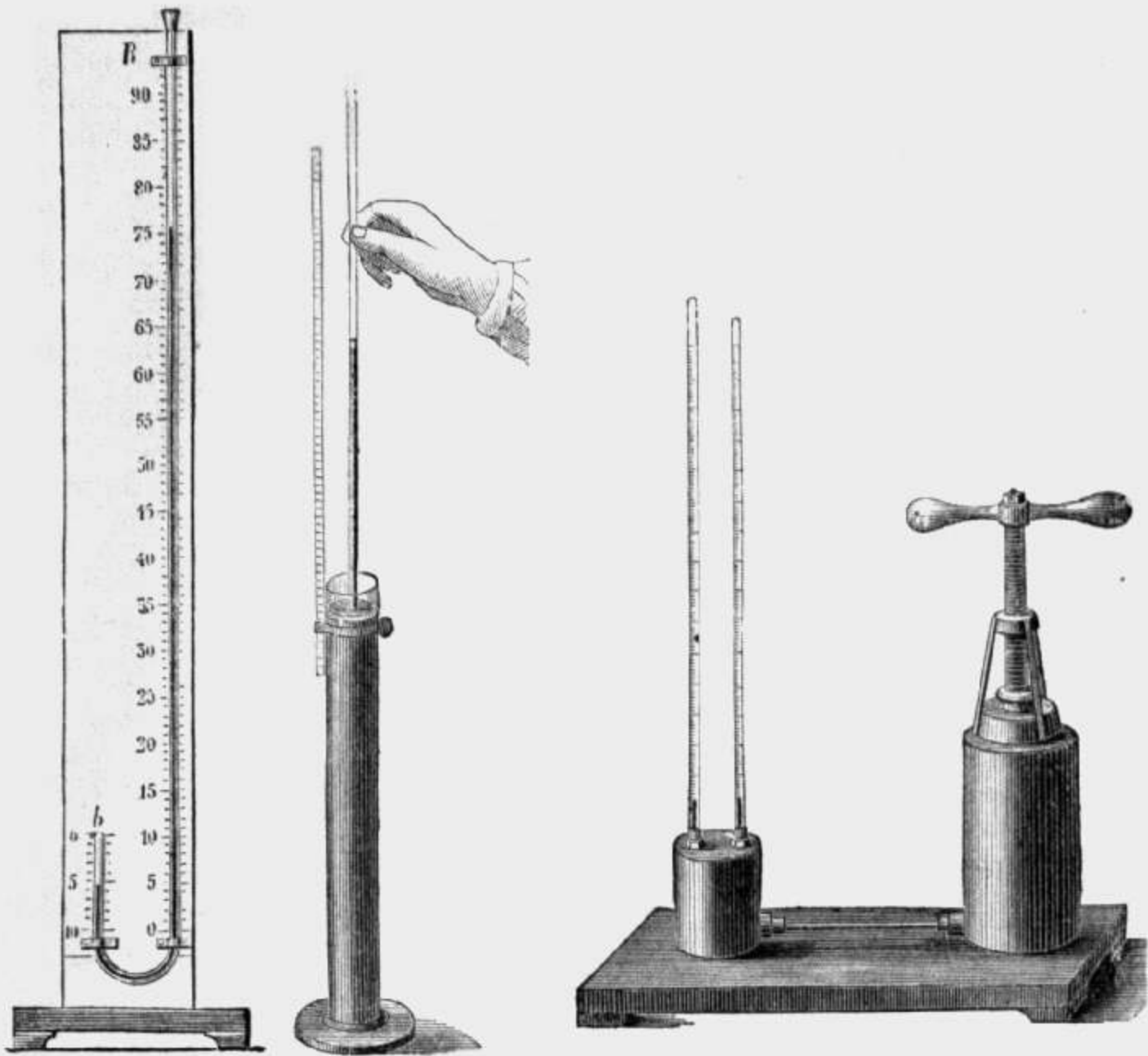

4351.

4353.

4354.

	PRICE
4351. <b>Mariotte's Law Apparatus.</b> Tube of glass on upright frame of mahogany, well polished. Funnel of brass. Whole instrument forty inches high. Scale for both arms . . . . .	\$10 00
4352. <b>Mariotte's Law Apparatus.</b> For pressures up to three atmospheres. Tubes of glass, in sections, with brass screw connectors. Neat mahogany frame, with scales for both arms. . . . .	25 00
4353. <b>Mariotte's Law Apparatus.</b> For pressures less than one atmosphere. Tank of glass, with scale, clamp, and strong barometer tube. . . . .	10 00
4354. <b>Apparatus to show the Comparative Compressibility of Different Gases.</b> Two strong barometer tubes in an iron cistern, and a chamber in which a strong pressure can be applied by a screw. On a polished mahogany base. . . . .	50 00
4355. <b>Guinea and Feather Tube.</b> Fitted also with point and ball for use as an <i>aurora</i> tube, with stop-cock, and strong cast-iron base. Tube three feet long. . . . .	8 00
4356. <b>Guinea and Feather Tube.</b> Similar to No. 4355, but four feet long. .	9 00
4357. <b>Guinea and Feather Tube.</b> Similar to No. 4356, but larger diameter	12 00

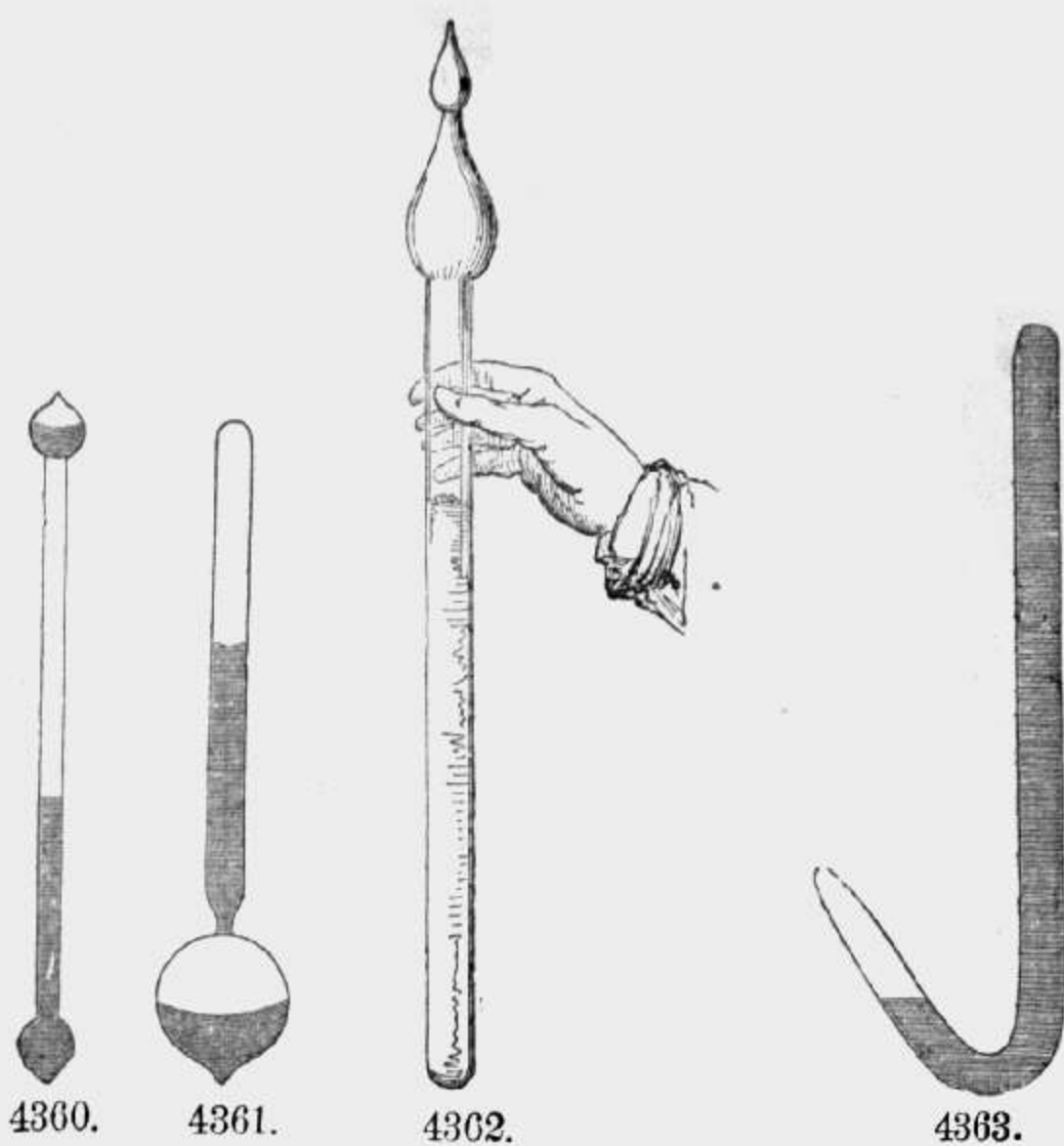

	PRICE
4360. <b>Water Hammer.</b> Straight form, nine inches long, with bulb on each end.....	\$1 00
4361. <b>Water Hammer.</b> Straight form, nine inches long, with bulb on one end.....	1 00
4362. <b>Water Hammer.</b> Straight form, fifteen inches in length, with bulb on one end.....	2 00
4363. <b>Water Hammer.</b> Bent form, twelve inches long, on vertical part of tube.....	2 00

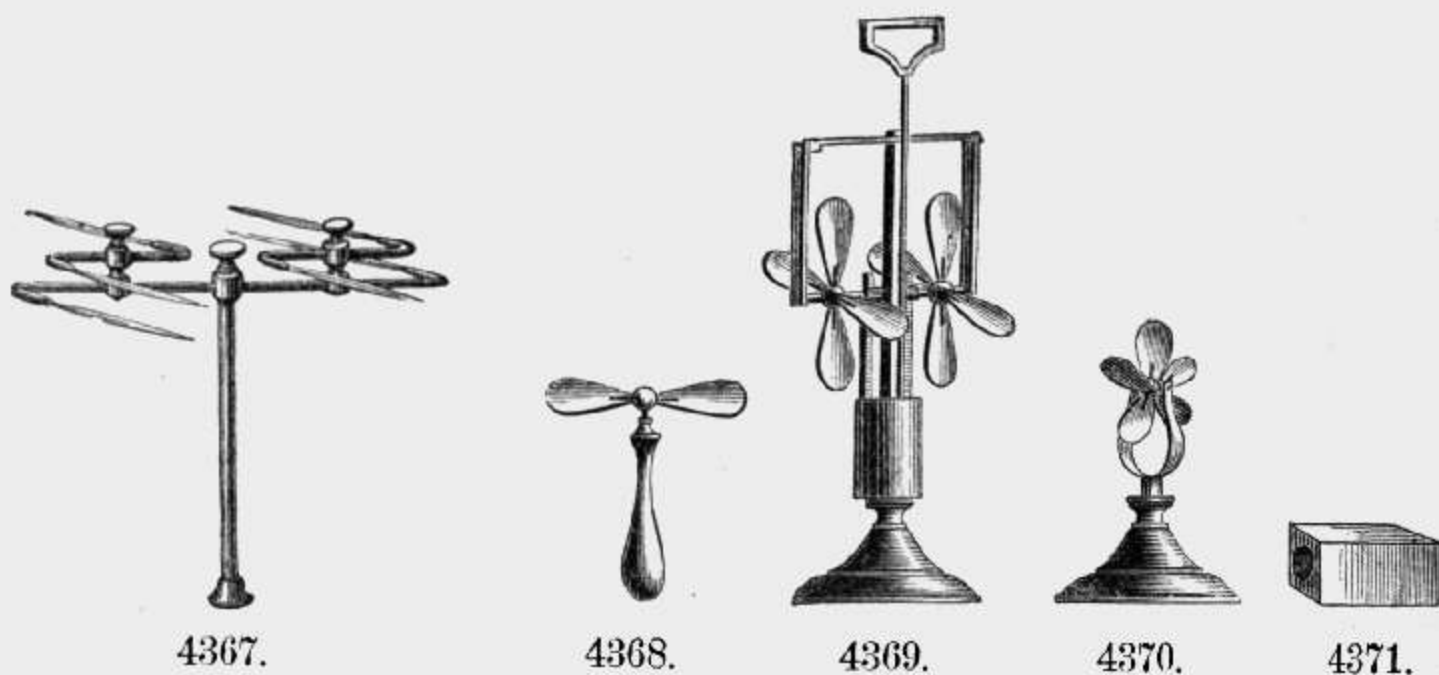

4366. <b>Single Revolving Jet.</b> Of brass, on stand.....	3 25
4367. <b>Triple Revolving Jet.</b> .....	6 50
4368. <b>Wind Mill.</b> To be used with the hand.....	1 25
4369. <b>Air Mill.</b> In which the fans are set in motion by a heavy weight, and a rack and pinion of brass.....	10 00
4370. <b>Resistance Fans.</b> Of brass, on an iron base.....	3 00
4371. <b>Block of Wood.</b> Loaded, to show porosity.....	50



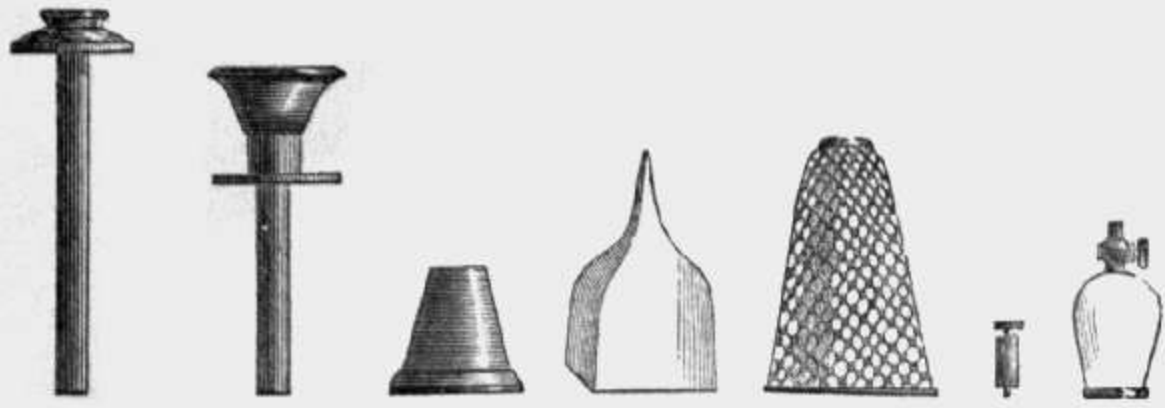

4372. 4373. 4374. 4380. 4381. 4382. 4383.

	PRICE
4372. <b>Air Shower.</b> A wooden cylinder, with a flange four inches in diameter, covered with sheet rubber.....	\$1 50
4373. <b>Mercury Funnel.</b> Brass flange, four inches in diameter, with wooden cup and cylinder.....	2 50
4374. <b>Apple Cutter.</b> Of brass, four inches in diameter .....	3 00
4380. <b>Bursting Squares of thin Glass,</b> three inches square. Per dozen...	2 50
4381. <b>Wire Guard</b> for No. 4380.....	75
4382. <b>Valve Cap</b> for No. 4380.....	50
4383. <b>Cupping Glass.</b> Glass about two inches in diameter, with small stopcock.....	3 50
4384. <b>Rubber Bag,</b> six inches in diameter ; to be placed under a receiver to show the expansion of air.....	2 25

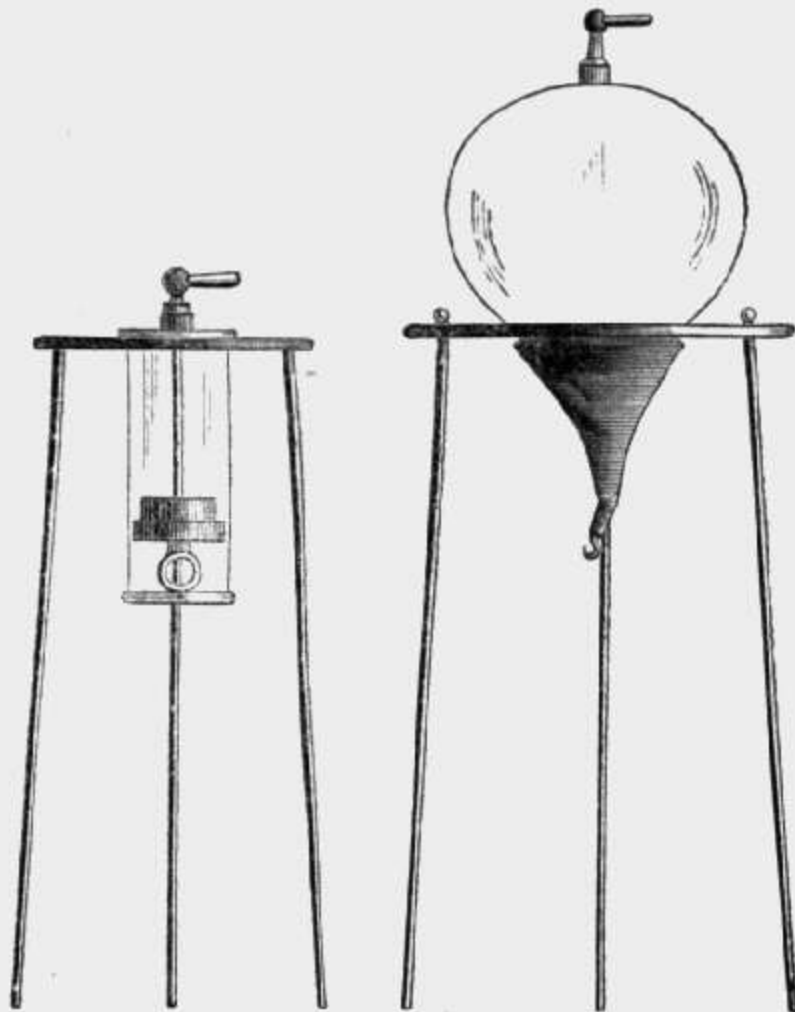

4385. 4384.

4385. <b>Upward Pressure Apparatus.</b> Strong glass cylinder, with piston, brass flange, and connector for rubber hose. Supported on a stout mahogany table, with iron legs. Without weights.....	12 00
4386. <b>Upward Pressure Apparatus.</b> Strong globular glass vessel, with brass cap and pipe at top, and stout rim, unground, below. To the latter is attached a strong rubber bag, with hook. The whole is supported upon a strong mahogany table, with iron legs. Without weights.....	13 00

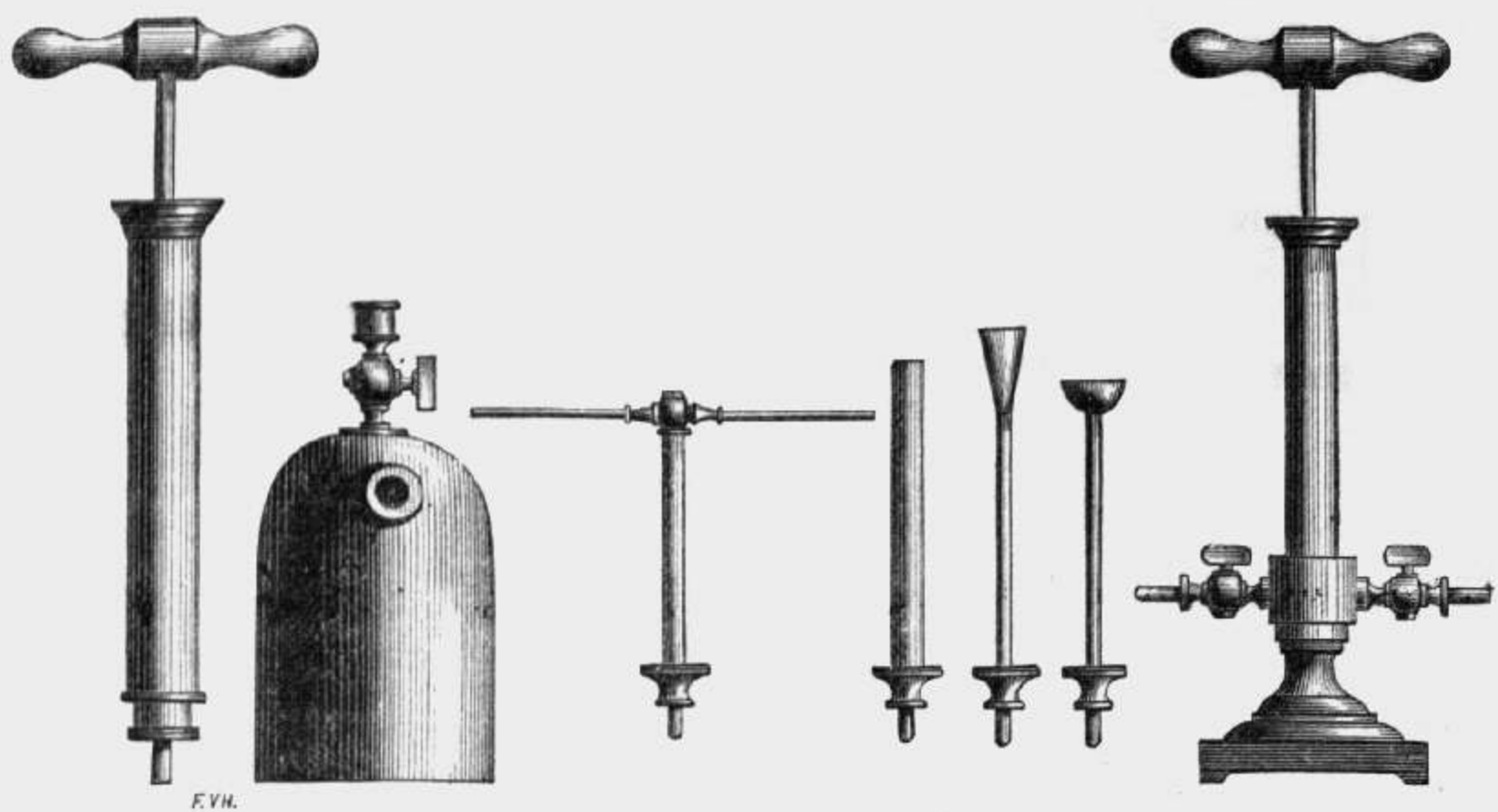

4390. 4391. 4393. 4394. 4396. 4398. 4400.

	PRICE
4390. <b>Condensing Syringe.</b> Convertible by reversing the valves into an exhausting syringe. Barrel of brass, eight inches long, and one and one-quarter inches in diameter.....	\$10 00
4391. <b>Copper Reservoir.</b> For compressed air, with two stop-cocks, to one of which is fastened a metal pipe reaching nearly to the bottom of the reservoir.....	10 00
4392. <b>Glass Reservoir.</b> For compressed air, with brass screw fittings and stop-cock.....	15 00
4393. <b>Revolving Jet.</b> Of brass, with arm seven inches in length.....	3 50
4394. <b>Air-Gun Jet.</b> Of brass, six inches long.....	1 00
4395. <b>Ball Paradox.</b> Of glass, seven inches long.....	75
4396. <b>Ball Paradox.</b> Of brass, six inches long.....	2 00
4397. <b>Plate Paradox.</b> Of brass, with mica discs.....	2 00
4398. <b>Fountain Jet.</b> Of brass, six inches long.....	2 50
4399. <b>Condensing Apparatus Complete.</b> Consisting of Nos. 4390, 4391, 4393, 4394, 4396, 4397 and 4398.....	27 50
4400. <b>Transferrer.</b> Pump of brass, eight inches long by one and one-quarter inches in diameter, mounted on a strong iron base, with entrance and exit stop-cocks.....	20 00

SECTION VII.—MANOMETERS.

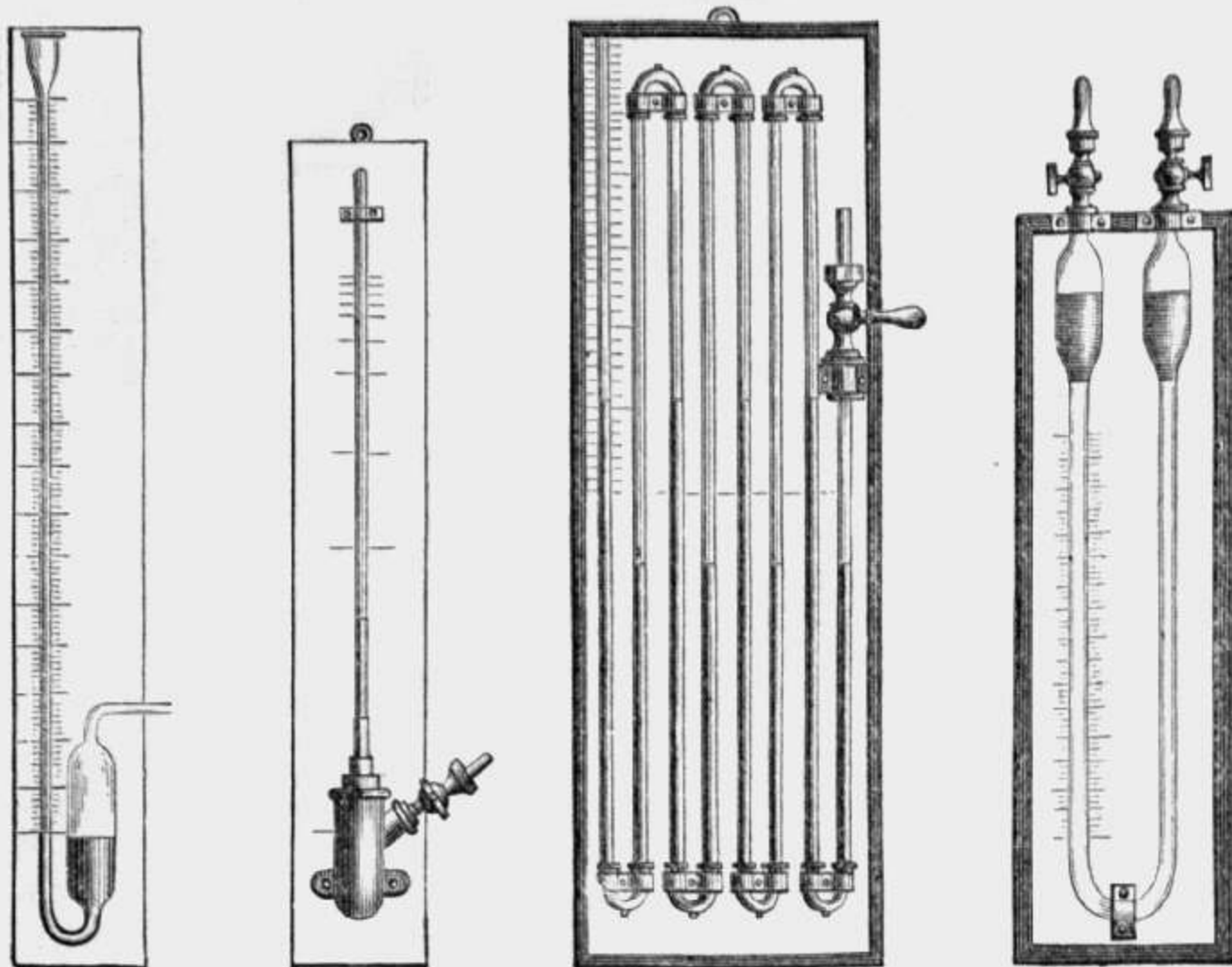

4425.

4426.

4427.

4428.

	PRICE
4425. <b>Open Manometer Tube.</b> To measure pressures less than one atmosphere. An upright tube of glass, thirty-six inches high, connected at the base, through a curved arm, with a strong glass reservoir for mercury, to the top of which the pressure is applied. On a neat mahogany frame, with scale.....	\$10 00
4426. <b>Closed Manometer Tube.</b> For pressures higher than one atmosphere. A strong iron cistern fitted with a closed vertical glass tube, and a side stop-cock. Mounted on a neat mahogany frame, thirty inches high, with scale.....	17 50
4427. <b>Compound Open Manometer.</b> Four pairs of tubes, connected by metal joints at top and bottom; the upper half of each tube is to be filled with water, the lower half with mercury. The last tube is of glass, and carries a scale showing the pressure. On a neat mahogany frame, forty inches high.....	25 00
4428. <b>Differential Manometer.</b> To register very small differences in pressure. Consists of a bent glass tube, placed upright and having a cylindrical bulb and a stop-cock on each arm. One bulb and both tubes, as far as zero of the scale, are filled with a mixture of alcohol and water. The other bulb and the remaining part of the corresponding tube are filled with a colored oil, of exactly the same specific gravity as the former mixture. A very slight difference in pressure is thus strikingly shown. Mounted on a neat mahogany frame, twenty-four inches high. Without liquids . . . . .	9 00
4429. <b>Comparative Manometer.</b> Consisting of two open manometers, placed side by side, with a common scale, and brass fittings and connectors. Mounted in a neatly polished walnut box, which closes when the instrument is not in use.....	12 00
4430. <b>Steam Gauge</b> for pressures up to 180 pounds to the inch.....	18 00
4431. <b>Steam Gauge</b> for pressures up to 250 pounds to the inch.....	22 50



## SECTION VII.—AIR-PUMP ACCESSORIES.

	PRICE
4440. <b>Rubber Hose for Connectors.</b> Strong enough not to collapse in exhausting, per foot.....	\$0 50
4441. <b>Rubber Hose for connections,</b> with cloth lining, <i>not elastic</i> , per foot.	60
4442. <b>Screw Couplings,</b> to connect hose with stop-cocks without twisting the hose, each.....	1 00
4443. <b>Stop-Cock of brass,</b> with outside screw on each end.....	2 00
4444. <b>Stop-Cock of brass,</b> with outside screw on one end and inside on the other.....	2 00
4445. <b>Stop-Cock of brass,</b> with inside screw on each end.....	2 00
4446. <b>Stop-Cock of brass,</b> with outside screw on each end, and with an additional small <i>inside</i> screw in one end.....	2 25
4447. <b>Small Stop-Cock of brass,</b> with outside screw on each end to fit the inside screw of No. 4446.....	1 50
4448. <b>Stop-Cock of iron,</b> for use with mercury, with outside screw on each end.....	3 00
4449. <b>Stop-Cock of iron,</b> with outside screw on one end and inside screw on the other.....	3 00
4450. <b>Brass Coupler,</b> with outside screws.....	75
4451. <b>Brass Coupler,</b> with inside screws.....	75
4452. <b>Brass Coupler,</b> with one inside and one outside screw.....	75
These couplers, Nos. 4450-52, fit the stop-cocks, Nos. 4443-46, and also any of the stop-cocks used with any of our pneumatic apparatus, as the thread is <i>uniform</i> throughout.	
4453. <b>Guard Screw,</b> for pump-plate.....	75
4454. <b>Bottle of Oil,</b> for pump.....	50
4455. <b>Leather Washers,</b> assorted, per hundred.....	50
4456. <b>Sheet rubber,</b> pure, very thin, per square foot.....	50
4457. <b>Sheet rubber,</b> pure, heavier than No. 4456, per square foot.....	50

## CHAPTER IV.

## UNDULATIONS.

4475. <b>White Silk Cord,</b> twenty feet long, very soft and pliable, to show the waves in cords, by fastening one end to a firm support, and starting the wave by the hand from the other.....	5 00
4476. <b>String of Silvered Beads,</b> twelve feet long, for the same purpose....	12 00
4477. <b>Melde's Apparatus.</b> A tuning-fork on stand, with a hook, cord and support.....	22 00
4478. <b>Melde's Apparatus.</b> Tuning-fork, three feet high, with hook, and white silk cord twelve feet long. On a heavy base.....	30 00
4479. <b>Melde's Apparatus.</b> Same as No. 4478, but with a magnetic interrupter, to keep up the vibrations.....	50 00

	PRICE
4482. <b>Circular Vase</b> , with spring and points to produce waves in fluids. . . .	\$15 00
4483. <b>Elliptical Vase</b> , to show the waves by reflection from a body of mercury. . . . .	3 00
4484. <b>Rectangular Vase</b> , for the same purpose. . . . .	3 00
4485. <b>Grand Rectangular Vase</b> , with bottom of glass, and with mirror to reflect the waves upon a screen. Lighted from below by the hydrogen light. Mounted on neat table. . . . .	50 00
4486. <b>Weber's Wave Canal</b> . A trough with glass sides, to show waves in water, by skilfully raising and depressing one end . . . . .	25 00
4487. <b>Rood's Wave Apparatus</b> . To show by projection that in the progressive motion of the wave the individual particles composing it do not themselves partake of the forward movement. . . . .	5 50
4488. <b>Wave Apparatus for projection</b> . Similar purpose as No. 4487, but arranged so as to be kept in action any required time. . . . .	25 00
4489. <b>Wave Apparatus</b> , for projection. To show the reflection of a wave. .	25 00
4490. <b>Dickerson's Wave Apparatus</b> , for projection. To show the propagation of a sound wave from a centre (sounding body) outward. Six rays show the arrangement of the particles of air as the wave progresses. . . . .	10 00
4491. <b>Wave Apparatus</b> , for projection. To show the arrangement of the air particles in a sounding organ-tube. One node . . . . .	25 00
4492. <b>Wave Apparatus</b> , for projection. Showing the vibrations of the ether in light waves. . . . .	25 00
4493. <b>Wave Apparatus</b> , for projection. Showing the interference of two vibrating movements. . . . .	25 00
4494. <b>Whole Series of Wave Apparatus</b> , Nos. 4488, 4489, 4491, 4492 and 4493, with a common stand for them all, instead of a separate stand for each. . . . .	90 00
4505. <b>Apparatus</b> to represent the molecular movement of an aerial wave produced by a simple shock. . . . .	16 50
4506. <b>Apparatus</b> to represent the molecular movement of aerial waves, produced by a continuous sound. . . . .	16 50
4507. <b>Apparatus</b> to represent the molecular movement of aerial waves confined in tubes. . . . .	22 00
4508. <b>Apparatus</b> to represent the molecular movements of liquid waves . . . .	45 00
4509. <b>Apparatus</b> to represent the molecular movement of waves of ether. . .	33 00
4510. <b>Wheatstone's Wave Apparatus</b> , to show the theoretical curves resulting from the co-existence of two systems of simple waves in the same plane; of two systems of waves perpendicular to each other; of one system of plane waves with another circular or elliptic; and finally, of two circular or elliptic systems. . . . .	250 00
4511. <b>Wheatstone's Wave Apparatus</b> . Similar to No. 4510, but without the resultants of the two circular or elliptic systems. . . . .	125 00
4512. <b>Apparatus</b> , showing the theoretical curves resulting from the co-existence of two systems of simple waves in the same plane. . . . .	44 00
4513. <b>Apparatus</b> , showing the theoretical curves resulting from the co-existence of two systems of equal and perpendicular waves. . . . .	22 00
4514. <b>Wheatstone's Apparatus</b> for the combination of two rectangular vibrations. . . . .	75 00
4515. <b>Apparatus</b> to show the effect upon a wave, caused by a movement to or fro of the exciting body. . . . .	60 00



## CHAPTER V.

## ACOUSTICS.

## SECTION I.

*Apparatus for the Production of Sound in General.*

	PRICE
4530. <b>Eight pieces of wood</b> , giving the gamut when struck in succession..	\$2 50
4531. <b>Four pieces of wood</b> , giving the chord.....	1 50
4532. <b>Water Hammer</b> .....	1 50
4533. <b>Four tubes</b> , with pistons, giving the chord when their pistons are successively drawn.....	13 00
4534. <b>Heavy or Bass Bow</b> .....	4 00
4535. <b>Violin Bow</b> .....	3 00
4536. <b>Bow</b> for vibrating plates by the middle.....	6 00
4537. <b>Whistling tube</b> of Cagniard de Latour.....	1 50
4538. <b>Philosopher's Lamp</b> .....	3 00
4539. <b>Steam Whistle</b> of brass.....	10 00
4540. <b>Universal Mouth-piece</b> .....	3 50
4541. <b>Mouth-piece</b> of Tube, with movable lever.....	3 50
4542. <b>Mouth-piece</b> of the Cornet.....	1 50
4543. <b>Mouth-piece</b> of the Trumpet.....	1 50
4544. <b>Mouth-piece</b> of the Clarionet....	2 00
4545. <b>Mouth-piece</b> of the Hautbois.....	1 50
4546. <b>Mouth-piece</b> of the Bassoon.....	1 50
4547. <b>Siren of Cagniard de Latour</b> , with cylindrical tube.....	8 00
4548. <b>Trevelyan Rocker</b> .....	6 00
4549. <b>Wertheim's Apparatus</b> .....	21 00
4550. <b>Magnetic Interrupter</b> , in which the vibrating spring is replaced by a diapason, $ut_2$ .....	60 00
4551. <b>Magnetic Interrupter</b> , with three diapasons, $ut_{-1}$ , $ut_1$ , $ut_2$ .....	100 00
4552. <b>Universal Magnetic Interrupter</b> , with two supports and ten diapasons, carrying riders, so that the experimenter can produce any desired number of interruptions per second, from 30 to 256.....	550 00

## SECTION II.—THE SIREN.

4560. <b>Siren of Cagniard de Latour</b> , with register.....	45 00
4561. <b>Toothed Wheel</b> of Savart, large model, with bar for the low pitch, and register.....	350 00
4562. <b>Toothed Wheel</b> of Savart, small but very satisfactory and portable model, without bar or register.....	100 00
4563. <b>Gyroscope</b> , with toothed wheel, answering the purpose of the wheel of Savart, very perfectly .....	10 00



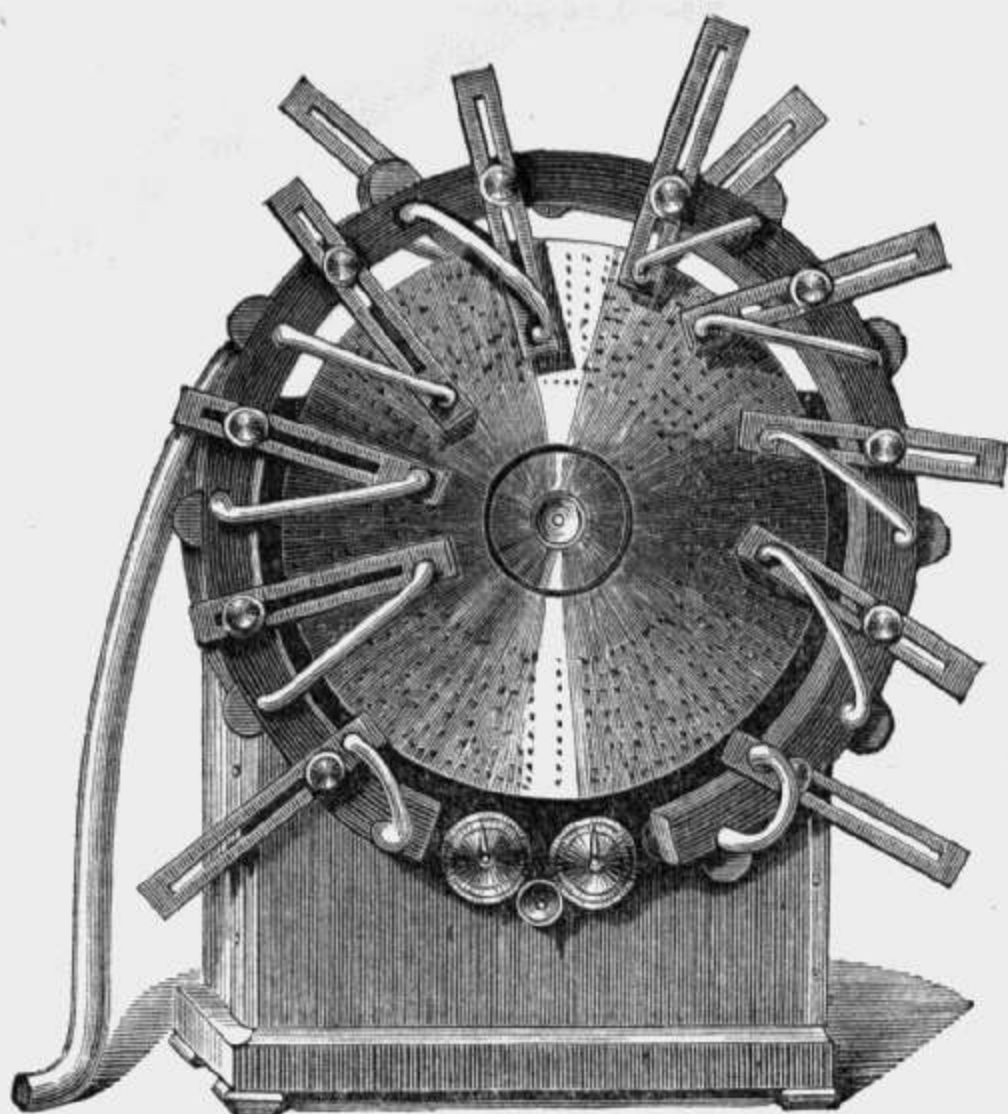

4564.

- |   | PRICE    |
|---|----------|
| 4564. <b>Grand Siren of Seebeck.</b> A strong system of clock-work, serves to keep in motion a copper disc, pierced with holes at regular intervals. A common air-chamber communicates with a series of tubes which can be accurately adjusted in front of the revolving disc, at any required position. A register gives the velocity of rotation. Of the nine discs furnished with the instrument, four are intended to show the results obtained when the <i>isochronism</i> of the impulses is imperfect from any cause; the fifth shows that impulses coming from different points can unite to form one sound; the sixth serves for experiments on interference; the seventh has eight series of holes, giving the gamut; the eighth has eight series of holes for the harmonics; the ninth illustrates the phenomena of beats. . . . | \$400 00 |
| 4565. Seebeck's Siren, with feebler clock work, without register, with seven discs of card-board. . . . .   | 150 00   |
| 4566. <b>Oppelt's Siren.</b> Disc of card-board, 19 inches in diameter, pierced with several series of holes, and adapted for use with any rotator. . . . .   | 20 00    |
| 4567. <b>Oppelt's Siren.</b> Same as No. 4566, but made of zinc instead of card-board. . . . .  | 30 00    |
| 4568. <b>Helmholtz's Double Siren.</b> For description see Tyndall's Lectures on Sound. . . . .   | 225 00   |

## SECTION III.—OF PITCH, INTENSITY AND TIMBRE.

- |  |       |
|--|-------|
| 4570. <b>Four Diapasons,</b> forming perfect chord, $ut_3$ , $mi_3$ , $sol_3$ , $ut_4$ , mounted upon resonant cases. . . . .                | 55 00 |
| 4572. <b>Diapason <math>ut_3</math>,</b> giving 256 complete vibrations per second, mounted upon its resonant case. . . . .                  | 14 00 |
| 4573. <b>Grand Diapason <math>ut_2</math>,</b> 128 vibrations, mounted upon its resonant case. . . . .                                       | 40 00 |
| 4574. <b>Official Diapason, <math>la_3</math>,</b> giving 435 complete vibrations, mounted upon its resonant case. . . . .                   | 14 00 |
| 4575. <b>Thirteen Diapasons,</b> with box, giving the tempered gamut from $ut_3$ to $ut_4$ , based upon the $la_3$ , 435 vibrations. . . . . | 55 00 |

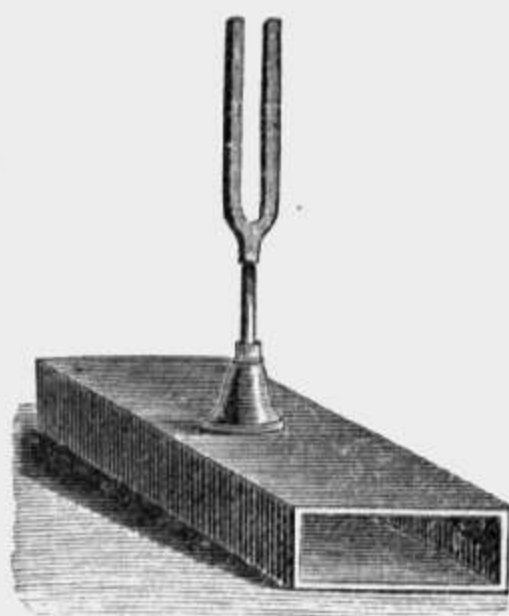

4572 and 4573.

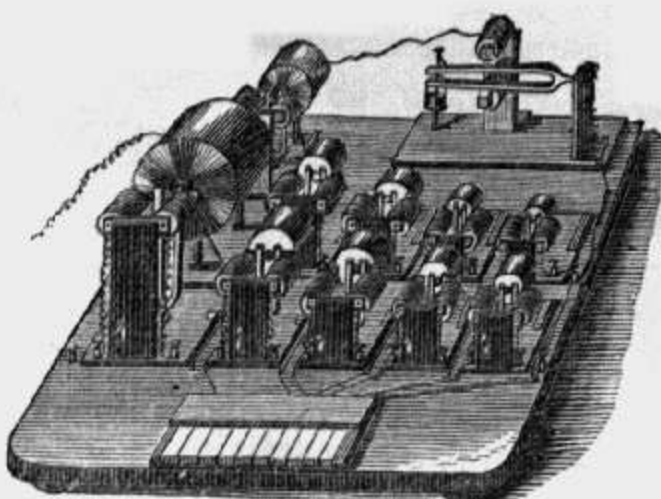

4581.

	PRICE
4577. Series of ten cylinders of Steel to determine the limit of acute sounds .....	\$30 00
4578. Helmholtz's Resonators. Series of ten .....	55 00
4579. Helmholtz's Resonators. Series of nineteen .....	82 00
4580. Helmholtz's Resonators. Series of fourteen adjustable from sol <sub>1</sub> to ut <sub>6</sub> .....	175 00
4581. Helmholtz's Apparatus for the artificial composition of the different "timbres" or "clang tints," consisting of ten diapasons fastened between the poles of ten electro-magnets, traversed by an intermittent current. These intermittences are produced by a diapason interrupter of 128 vibrations per second. ....	420 00
4582. Helmholtz's Apparatus. Same as No. 4581, but with the addition of ten diapasons giving the harmonics. ....	500 00

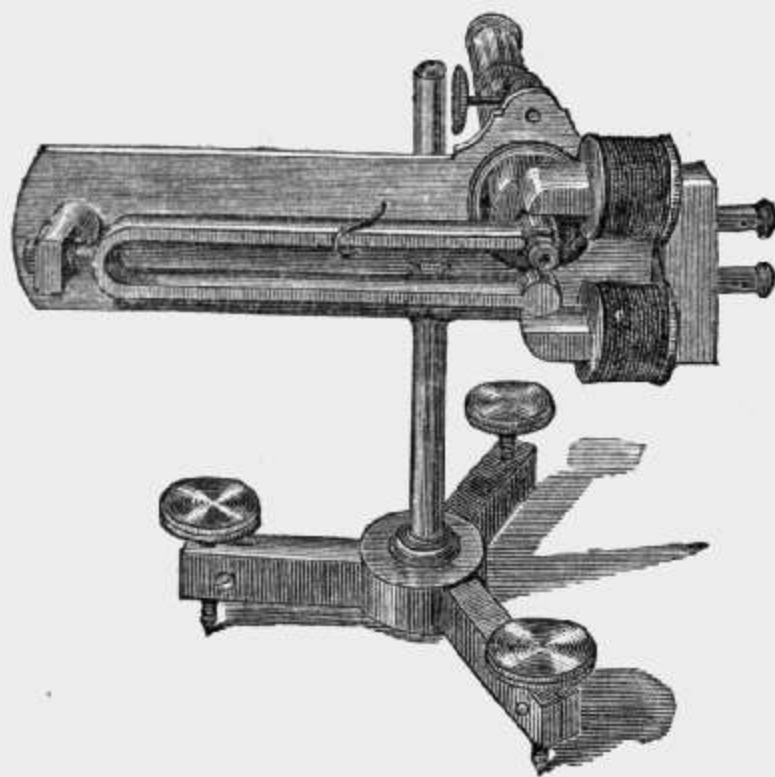

4584.

4583. Optical Comparer of M. Lissajous, without electro-magnet. ....	42 50
4584. Optical Comparer of M. Lissajous, with electro-magnet. ....	65 00
4585. Five Diapasons, with resonators in unison with the air-chambers of the mouth in the utterance of the vowels a, e, i, o, u. ....	55 00



## SECTION IV.—OF THE PROPAGATION, REFLEXION AND REFRACTION OF SOUND.

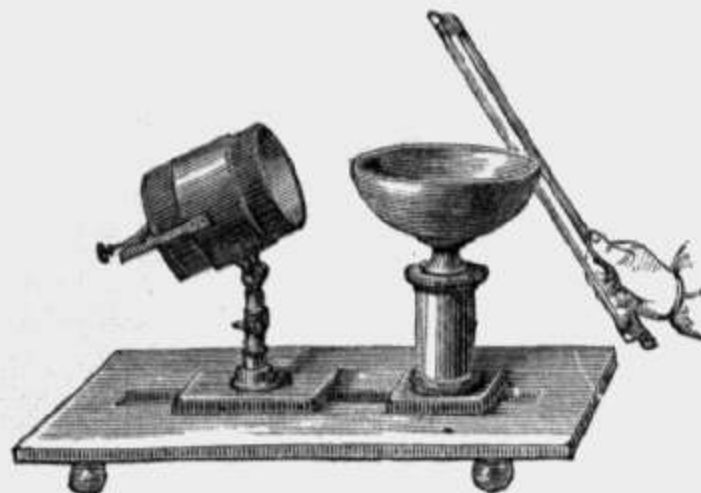

4599.

	PRICE
4595. <b>Bell</b> , suspended from a brass frame by silk cords, to show the enfeeblement of sound in a vacuum.....	\$4 00
4596. Bell, with clock-work, suspended by silk cords, from a brass frame, which is in turn supported on a piece of India rubber.....	20 00
4597. <b>Chladni's Apparatus</b> , to cause an organ tube to sound in different gases.....	16 50
4598. <b>Ten Bars</b> , each one metre in length, of different kinds of wood.....	12 50
4599. <b>Savart's Bell and Resonator</b> . Bell ten inches in diameter, mounted upon a solid support, and resonator eight inches in diameter, adjustable in all directions, upon a polished mahogany table.....	35 00
4600. <b>Resonant Jars</b> , for diapasons No. 4570. Series of four for chord. ...	8 00
4601. Resonant Jars, for diapasons. Series of eight for octave.....	16 00
4602. <b>Seebeck's Ear</b> .....	12 50
4603. <b>Pair of Parabolic Reflectors</b> , thirteen inches in diameter, on adjusting stands.....	50 00
4604. Pair of Parabolic Reflectors, twenty inches in diameter, on adjusting stands.....	75 00
4605. <b>Lens of India Rubber</b> , eighteen inches in diameter, consisting of a brass ring with two sheets of thin rubber fastened upon it and securely covered. A stop-cock communicating to the space between the two rubber sheets allows the entrance of any gas desired, and the closing of the stop prevents the exit. On neat mahogany stand.	25 00
4606. Lens of India Rubber, similar to No. 4605, without the stop-cock, or brass ring, and only twelve inches in diameter.....	5 00
4607. <b>Two Diapasons</b> ut <sub>4</sub> , mounted upon their resonant cases, and adjusted to give four beats per second.....	27 50

## SECTION V.—OF VIBRATIONS.

## 1. VIBRATIONS OF AIR.

4620. <b>Large Bellows</b> , with regulator.....	250 00
4621. Bellows, smaller than No. 4620, with regulator.....	150 00
4622. Bellows, same as No. 4621, but without regulator.....	112 50
4623. <b>Manometer</b> , to measure the pressure of the air.....	5 00
4624. <b>Organ Tube</b> , plain, for simple illustration.....	2 50
4625. <b>Open Organ Tube</b> , with one side of glass, with a membrane and cord which can be lowered into the tube, and which will sound in any position in the tube, except at the node.....	8 00
4626. <b>Long Open Tube</b> , one of whose faces is very thin, so that by strewing this face with sand the position of the nodes in the vibrating column of air can be distinctly seen.....	5 50
4627. <b>Open Tube</b> , for manometric flames.....	20 00
4628. <b>Closed Tube</b> , for manometric flames.....	20 00



	PRICE
4629. <b>Organ Tube</b> , with a key at the node, permitting the tube to be closed at this point. . . . .	\$4 50
4630. Organ Tube, with stop-cock at the middle of the vibrating column..	3 50
4631. Organ Tube, with a slide, having holes of various sizes which open at the middle of the vibrating column . . . . .	8 00
4632. Three Equal Tubes, with lumière of different sizes. . . . .	8 00
4633. Tube, which can be closed at the end by a sliding plate, pierced with four holes, which serve successively for mouth-piece. . . . .	8 00
4634. Cubical Tube, arranged as No. 4633. . . . .	8 00
4637. Three similar tubes, in wood of different thickness. . . . .	8 00
4638. Two similar tubes, the interior of one of them lined with cloth. . . . .	5 50
4639. Three similar tubes, one of brass, one of wood, and one of card-board.	12 00
4640. Five tubes of the same size and different lengths, giving the notes ut, ré, mi, fa, sol; and four tubes of the same length and different sizes, giving the notes ré, mi, fa, sol. . . . .	32 50
4641. Cubical Glass Tube, with three pistons, by means of which one can diminish the mass of air contained, alternately, according to the three dimensions, to show the comparative influence of the different dimensions upon the sound. . . . .	22 50
4642. Four Rectangular Tubes (one a cube), giving the same note. . . . .	17 00
4643. Two Closed Cubical Tubes. . . . .	10 00
4645. Two Long Tubes of Glass, one open, the other closed, to give the succession of harmonics. . . . .	5 00
4646. A Long Open Tube, giving a succession of notes corresponding to the numbers 1, 2, 3, 4, which can be opened at the middle of each vibration, and closed at each node by a piston. . . . .	10 50
4647. A Long Tube, closed at one end, same style as No. 4646, with six stop-cocks, and one piston, giving notes corresponding to the numbers 1, 3, 5, 7. . . . .	10 50
4648. A Long Tube, closed at both ends, with movable mouth-piece, which gives, if the mouth-piece remains in the middle, notes as 1, 3, 5, 7, but if moved, the notes 1, 2, 3, 4. . . . .	26 00
4649. Circular Tube. Giving notes 1, 3, 5, 7, which carries a key at the spot where the node always forms. . . . .	13 00
4650. <b>Flute</b> . Composed of a mouth-piece, of two open tubes, each the length of a wave, and one tube the length of half a wave. . . . .	5 50
4651. <b>Water Flute</b> . Composed of two tubes of glass, of different diameters, worked by two flowing columns of water. On neat stand. . . . .	40 00
4652. <b>Four Tubes</b> . Containing the same mass of air, with mouth-pieces of the same size, one a tetrahedron, one a cube, one a cylinder, and one a sphere. . . . .	22 00
4653. Three Tubes. Of the same length, and containing the same volume of air. One is prismatic and the two others conical. One of the latter tapers just as much toward the mouth-piece as the other does from it. . . . .	10 00
4654. Five Tubes. Of the same length, but bent in different ways. . . . .	22 00
4655. Eight Open Tubes. Giving the gamut from ut <sub>3</sub> to ut <sub>4</sub> . . . . .	22 00
4656. Eight Closed Tubes. Giving the same notes as No. 4655. . . . .	22 00
4657. Four Open Tubes. Giving the perfect chord. . . . .	11 00
4658. Four Closed Tubes, giving the perfect chord. . . . .	11 00

## 2. VIBRATIONS OF MEMBRANES.

4665. <b>Circular Membrane of Rubber</b> , which can be stretched at will. . . . .	5 50
4666. <b>Circular Membrane of Paper</b> . About twelve inches in diameter. . . . .	3 50
4667. <b>Square Membrane of Paper</b> . Twelve inches on a side. . . . .	3 00
4668. <b>Triangular Membrane of Paper</b> . Twelve inches on a side. . . . .	3 00



## 3. VIBRATION OF CORDS.

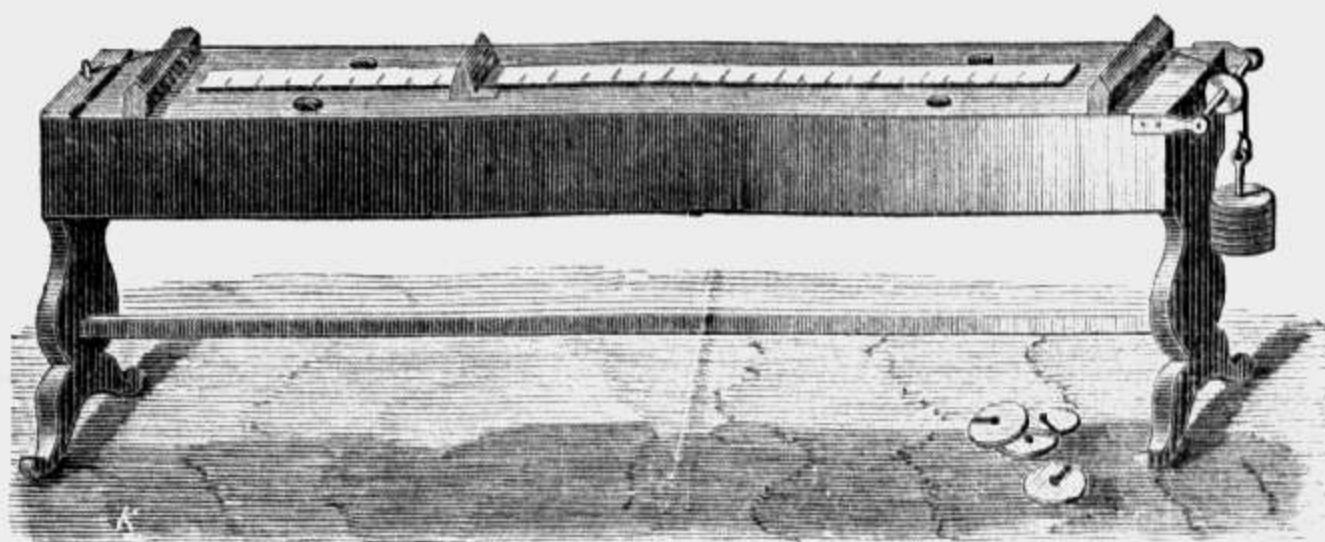

4676.

	PRICE
4675. <b>Sonometer</b> , plain form, sounding-board, bridges, key and cord.....	\$10 00
4676. <b>Sonometer</b> , of mahogany, with sounding-board of spruce, one metre in length between the bridges, two cords and weights, scale to millimetres, and movable bridges for the octave, thirds, &c.....	30 00
4677. <b>Differential Sonometer</b> , with assortment of weights. This instrument is one metre in length between the bridges. Carries three scales, the first the chromatic tempered gamut; the second, the true chromatic gamut and the harmonics; the third is a metre divided to millimetres throughout its length.....	50 00
4678. <b>Apparatus</b> for studying the longitudinal vibrations of cords, one metre in length.....	75 00
4679. <b>Two Sonometer Cords of Brass</b> , whose diameters are as 1 to 2.....	50
4680. <b>Two Cords</b> of the same diameter, one of iron the other of platinum..	3 50
4681. <b>Grand Sonometer</b> of M. Berbereau, having eight cords for experiments upon the gamut, &c., &c.....	150 00

## 4. VIBRATIONS OF RODS AND BARS.

4690. <b>Four Bars of Steel</b> , of which two are of the same length, same thickness, and different width; a third same length as first and double the thickness; and a fourth of the same thickness as the first but its length is to that of the others as 1: 2.....	15 00
4691. <b>Four Bars of Brass</b> , similar to No. 4690.....	7 50
4692. <b>Four Bars of Wood</b> , do. do. ....	3 00
4693. <b>Six Bars</b> of same size, five of wood of different kind and density, and one of brass.....	6 00
4694. <b>Two Flat Springs of Brass</b> , one a metre in length, the other a half metre, to show the law of the harmonics in transverse vibrations..	6 00
4695. <b>Four Springs of Brass</b> , of the same length, one straight and the others successively more and more curved, to illustrate the nodes in the diapason.....	7 50
4696. <b>Four Springs of Steel</b> , two cylinders of one metre in length and of different diameters, a bar of the same length, and a cylinder half the length.....	20 00
4697. <b>Four Springs</b> , as in No. 4696, but of wood.....	3 00
4698. <b>A Rod and a Tube of Brass</b> , of same diameter, and one metre in length.....	20 00
4699. <b>A Rod of Brass</b> , supported horizontally in a frame, with one end just touching an ivory ball suspended from a frame. As soon as the bar is put into vibration the ball is repelled.....	20 00
4700. <b>Apparatus</b> , to show the nodes on a body vibrating longitudinally, consists of a hair with small rings on it, stretched between two keys on a strong frame.....	3 00

- |   | PRICE  |
|---|--------|
| 4701. <b>The Claque Bois.</b> A musical instrument founded upon the transverse vibration of bars.....   | \$7 50 |
| 4702. <b>Marloye's Harp.</b> A musical instrument, founded on the longitudinal vibrations of rods, consisting of twenty rods of wood, fastened in a strong support. The white rods give the diatonic gamut, the red rods the half tones; the sound is produced by playing upon the rods with rosined fingers..... | 30 00  |

5. VIBRATION OF PLATES.

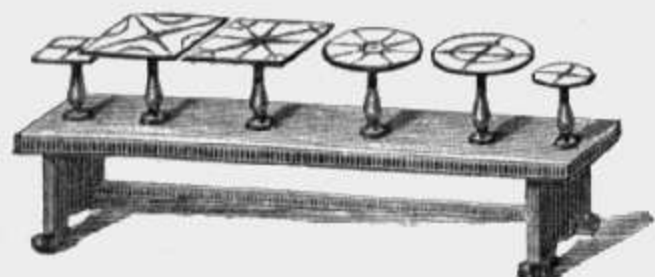

4710.

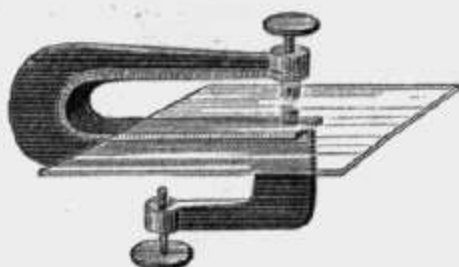

4719.



4721.

- |  |       |
|--|-------|
| 4710. <b>Bench</b> , with Screw Supports for Six Plates of Brass, three round and three square. Two plates of each shape are of the same size, but one double the thickness of the other. Each pair is accompanied by a third plate of the same thickness as the first but of half the diameter..... | 35 00 |
| 4711. Smaller Bench, with three plates only, either round or square.....   | 20 00 |
| 4712. <b>Circular plate of brass</b> , 12 inches in diameter.....  | 7 50  |
| 4713. <b>Square plate of brass</b> , 12 inches on the side.....  | 7 50  |
| 4714. <b>Triangular plate of brass</b> , 12 inches on a side.....  | 7 50  |
| 4715. <b>Hexagonal plate of brass</b> , 12 inches across.....  | 7 50  |
| 4716. <b>Series of four plates of plate-glass</b> , finely finished, nine inches on a side, or in diameter, including the circle, square, triangle, and hexagon.....   | 12 00 |
| 4717. <b>Series of four plates of plate-glass</b> , finely finished, five inches on a side, or in diameter, including the circle, square, triangle, and hexagon. For use in projection.....  | 8 00  |
| 4718. <b>Universal support for plates</b> , composed of four screw-clamps. ....  | 20 00 |
| 4719. <b>Simple support for plates</b> , to be clamped to a table.....   | 5 00  |
| 4720. <b>Simple support for plates</b> , to be held in the hand.....   | 5 00  |
| 4721. <b>Simple support for plates held at the centre</b> .....  | 5 50  |
| 4722. <b>Support for plates when used for projection</b> , having, besides the main clamp, another to fasten at the node.....  | 15 00 |
| 4723. <b>Glass Bell</b> , mounted upon a base. A frame carries four balls, which touch the edge of the bell. When the bell is set into vibration by the bow the balls are repelled if they are not in the nodes.....   | 12 50 |

SECTION VI.—ON THE COMMUNICATION OF VIBRATIONS THROUGH THE AIR, OR OTHERWISE.

- |  |       |
|--|-------|
| 4730. <b>Two Diapasons</b> $ut_3$ in unison, and mounted upon their resonant cases.....  | 27 50 |
| 4731. <b>Two plates of brass</b> of the same form, size, and thickness, one of which is mounted upon a base and the other with a handle. On setting the latter in vibration and holding it above the former, having strewn black sand over each, the vibration will be transmitted to the lower one, and the sand on both the plates will assume the same figures..... | 12 50 |



	PRICE
4732. <b>Tube of Brass.</b> Twenty-four inches long, with a plate of brass ten inches in diameter attached to one end. A hoop, with either of the discs Nos. 4665 or 4666, is placed upon the floor or table, and the experiment No. 4731 is performed by rubbing the tube with a rosined rag.....	\$6 00
4733. <b>Tube of Glass.</b> For singing flame, mounted on a base.....	4 00
4734. <b>Tube of Glass.</b> For sensitive flame, mounted on a base.....	4 00
4735. <b>Set of four Glass Tubes.</b> For sensitive flames, mounted on a neat base, with hose for each tube.....	15 00
4733. <b>Tube of Brass.</b> For singing or sensitive flame, with support for glass tube on the same stand.....	9 00
4737. <b>Neatly Japanned Tin Tube.</b> One metre in length.....	3 00
4738. <b>Neatly Japanned Tin Tube.</b> Two metres in length.....	6 00
4742. <b>Apparatus</b> for the transmission of vibrations through liquids.....	5 50
4743. <b>Free Reed.</b> Carried upon a glass wind-chest, surmounted by a tube in unison with the reed, and which can be lengthened to triple its length.....	12 50
4744. <b>Free Reed.</b> Mounted upon a glass wind-chest, with two harmonic cornets of different form to show their influence upon the timbre..	11 00
4745. <b>Beating Reed.</b> Mounted as No. 4744, and carrying the same cornets..	11 00
4750. <b>Two square plates of Brass.</b> Fastened together by one corner. One larger than the other.....	5 00
4751. <b>Two round plates of Brass</b> of different sizes. Joined by their circumference.....	5 00
4752. <b>Two square plates.</b> Of same size, joined by the corner.....	5 00
4753. <b>Two round plates.</b> Same size, joined by the circumference.....	5 00

SECTION VII.—ON THE PHENOMENA RESULTING FROM THE CO-EXISTENCE OF TWO OR MORE SOUNDS IN THE AIR.

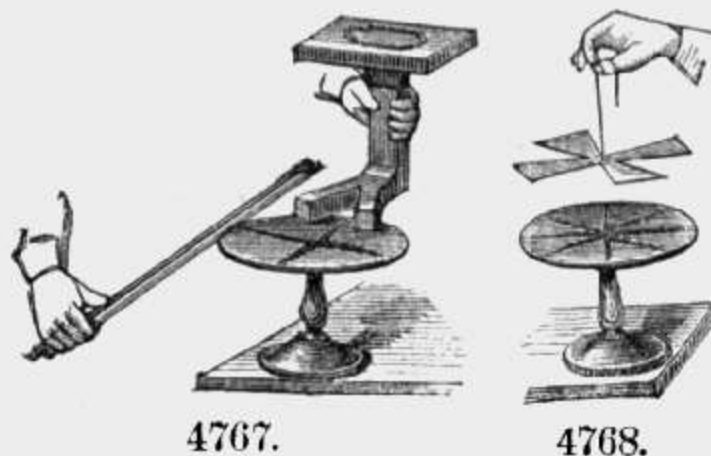

4765. <b>Two Diapasons</b> $ut_2$ in unison. Each mounted upon a support, between the poles of an electro-magnet, with a diapason interrupter $ut_2$ .....	165 00
4766. The two Diapasons of No. 4765, without the interrupter.....	90 00
4767. <b>Interference Tube.</b> Tube with two arms, surmounted by a disc of thin paper. When held over the opposite sections of a vibrating plate, the vibrations of the two arms of the tube act in unison; when held over contiguous sections the one neutralizes the other.....	10 00
4768. <b>Interference Apparatus</b> of M. Lissajous. A circular plate of brass on stand, and three discs of zinc, cut to correspond with the successive divisions of the plate in vibration.....	40 00
4769. <b>The three Discs of Zinc</b> of No 4768, without the plate and stand....	25 00

	PRICE
4770. <b>Five open Organ Tubes.</b> Two giving $ut_2$ , and the others $mi_2$ , $sol_2$ , and $ut_3$ . All so adjusted that they can be made to vary half a tone.	\$42 00
4771. Two Organ Tubes. Giving $ut_2$ , and adjustable as in No. 4770.....	21 00
4772. Two open Tubes. Giving the fourth. For the resultant sounds....	4 50
4773. <b>Helmholtz's Double Siren</b> .....	225 00

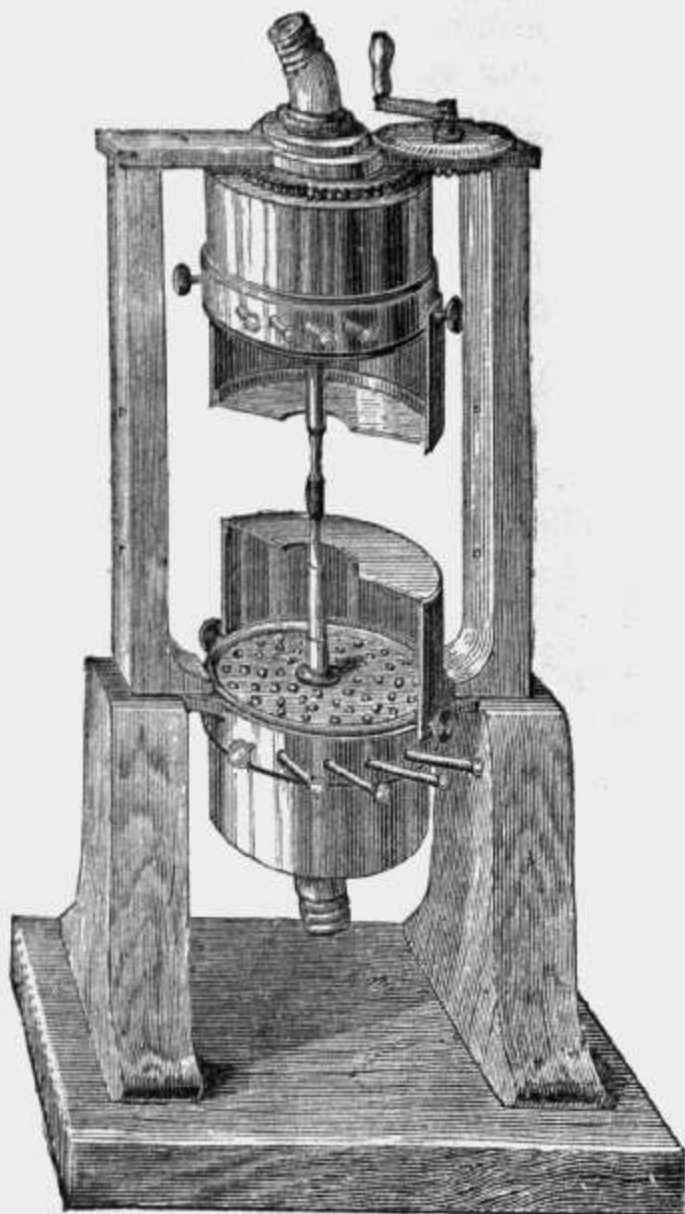

4773.

SECTION VIII.—METHODS OF OBSERVING SONOROUS VIBRATIONS WITHOUT THE USE OF THE EAR. COMPRISING THE GRAPHIC METHOD; THE OPTICAL METHOD; THE METHOD OF MANOMETRIC FLAMES; AND THE METHOD WITH THE STROBOSCOPE.

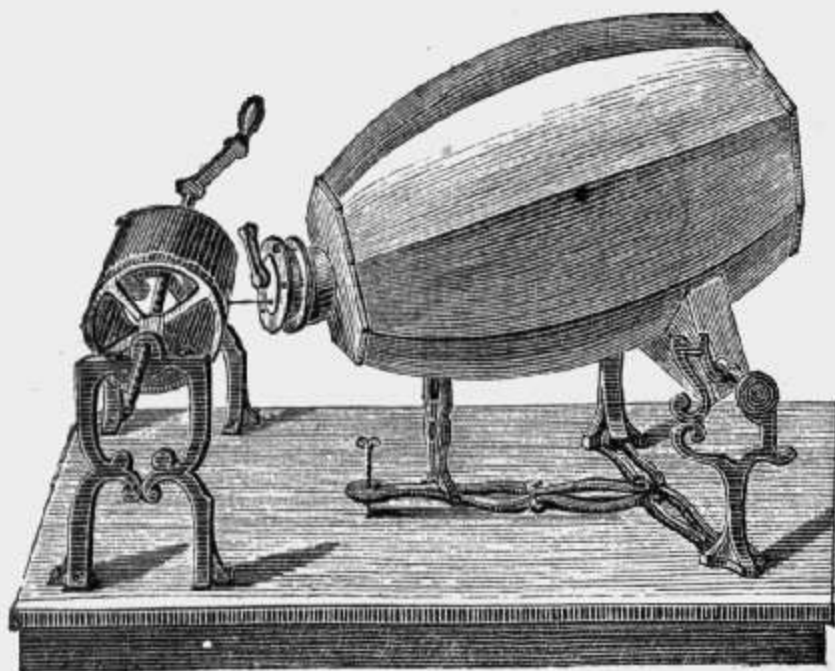

4785.

4785. <b>The Phonautograph.</b> With chronometer marker, and diapason chronoscope, complete .....	250 00
---	--------



	PRICE
4787. <b>The Cylinder</b> on its stand, chronometer marker, diapason chronoscope, and stands of No. 4785, without the vibrating membrane and tracer. ....	\$137 50
4788. <b>The Cylinder</b> , with the screw movement and crank alone, on its stand	80 00
4789. <b>Regnault's Chronograph</b> . Consisting essentially of a Bond's magnetic register, with three pairs of diapasons dividing the space on the cylinder, indicating seconds, into the $\frac{1}{50}$ , $\frac{1}{100}$ or the $\frac{1}{60}$ part. With apparatus for rolling on and fuming the paper to be used. ...	500 00
4790. <b>Regnault's Chronograph</b> similar to No. 4789, but with only one pair of diapasons. ....	400 00
4791. <b>Regnault's Chronograph</b> , with one pair of diapasons, but without the apparatus for rolling and fuming the paper. ....	300 00
4792. <b>Interrupter</b> , with four diapason interrupters of 30, 60, 120, and 180 per second; and a support, fitted with electro-magnet suited to receive four writing diapasons in unison with the above. ....	200 00
4793. <b>Interrupter</b> . Similar to No. 4792, but with three pairs of diapasons. 50, 100 and 200 to the second. ....	165 00
4794. <b>Interrupter</b> . As No. 4792, but with three pairs of diapasons, 32, 64 and 128 per second. ....	165 00
4795. <b>Interrupter and Marker</b> . Of $\frac{1}{100}$ of a second. ....	100 00
4796. <b>Interrupter and Marker</b> . Of $\frac{1}{30}$ of a second. ....	110 00
4801. <b>Large Lissajous Apparatus</b> . Or apparatus for the optical method alone. Microscope for comparing ten large diapasons, with polished steel mirrors and riders with adjustments from $ut_1$ to $ut_3$ . With stand and lamp. ....	600 00
4802. <b>Lissajous Apparatus</b> . For the composition of <i>two movements</i> by the optical method. Six diapasons with steel mirrors, and stand and a lamp. ....	175 00
4803. The same as No. 4802, but with feebler diapasons and glass mirrors.	110 00
4804. <b>Lissajous Apparatus</b> . With <i>four</i> diapasons. ....	82 50
4805. <b>Open Organ Tube</b> . With capsules and gas jets to show the position of the nodes by the method of <i>manometric flames</i> . ....	20 00
4806. <b>Closed Organ Tube</b> . As No. 4805. ....	20 00

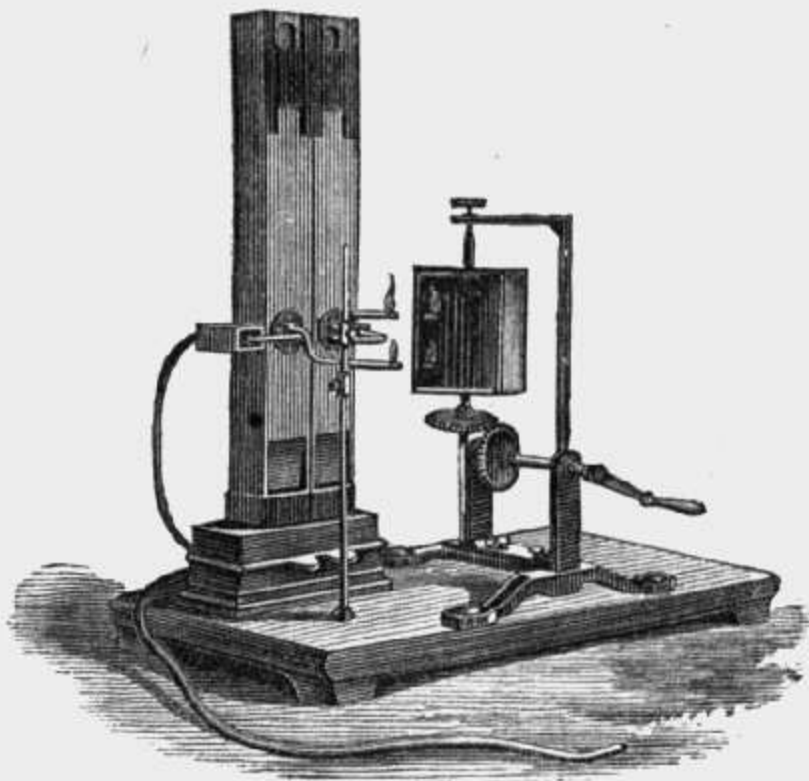

4807.

4807. **Apparatus for the comparison and composition of the vibrations of two columns of air by the method of manometric flames**, with five tubes, two  $ut_2$ , and the three others  $mi_2$ ,  $sol_2$ , and  $ut_3$ . So arranged that each can be varied half a tone. ....

100 00



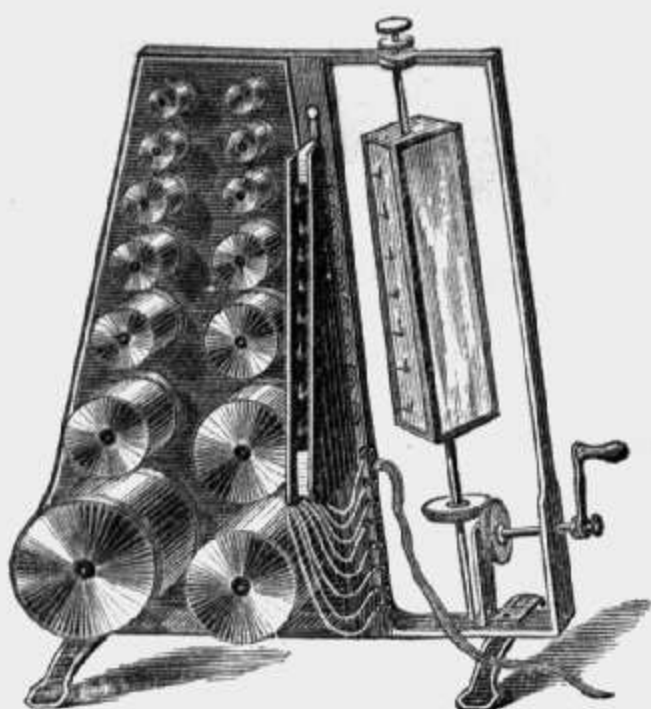

4809.

- |  | PRICE    |
|--|----------|
| 4808. <b>Apparatus.</b> To resolve, in a manner to be seen by the eye, the "timbre" of a sound into its elementary notes by means of manometric flames. The ten Helmholtz Resonators No. 5578 are fixed upon a support one above the other. Each communicates by a small rubber tube with a little cavity which forms the manometric capsule. The gas jets of these capsules are placed one above the other, upon an inclined line, and a revolving mirror whose axis is parallel to this line, decomposes those of the flames which are put into vibration by the resonant globes, while those flames not put into vibration appear simply as a line of light. .... | \$150 00 |
| 4809. <b>Apparatus.</b> Same as No. 4808, but with fourteen adjustable resonators, suited to the analysis of the <i>timbre</i> of any sound whatever. ....   | 300 00   |
| 4810. <b>Small Revolving Mirror.</b> With a manometric capsule on stand, with rubber tube to attach the resonator. ....  | 20 00    |
| 4811. <b>Manometric Capsule</b> alone, with rubber tube. ....  | 10 00    |
| 4813. <b>Kundt's Vibroscope.</b> For polarization. ....  | 100 00   |
| 4814. <b>Strong Vise and long bar of glass</b> to show same as No. 4813. ....  | 25 00    |
| 4815. <b>Apparatus to Examine the Vibrations of Bodies by the Stroboscopic Method.</b> Composed of a universal electric interrupter, with two supports and ten graded diapasons, with riders. The diapasons range from $ut_1$ to $ut_3$ , and the positions of the riders for intermediate vibrations are marked upon the branches. An arrangement for opening and closing a narrow slit, by means of an electro-magnet, so that a light, intermittent in its nature, may fall upon the body whose movements are to be studied, completes the whole. ....  | 500 00   |
| 4816. <b>Wheatstone's Kaleidophone.</b> Consisting of twelve bars whose vibrations produce the figures of the rectangular combination of two vibrations for different intervals. ....  | 50 00    |
| 4817. <b>Wheatstone's Kaleidophone for projection.</b> Similar to No. 4816, but with steel mirrors and a base of lead to be held in a vise. ....   | 80 00    |
| 4818. <b>Wheatstone's Kaleidophone.</b> With only six bars. ....   | 30 00    |
| 1819. <b>Wheatstone's Kaleidophone for projection,</b> with only six bars. ....  | 40 00    |
| 4820. <b>A Series of Reed Pipes</b> giving the gamut, $ut_3$ to $ut_4$ , carrying mirrors by which the vibrations of the reed can be thrown upon a screen, and the relation between the different notes made apparent to the eye. ....   |          |

## CHAPTER VI.

## HEAT.

## SECTION I.—ARTIFICIAL SOURCES OF HEAT.

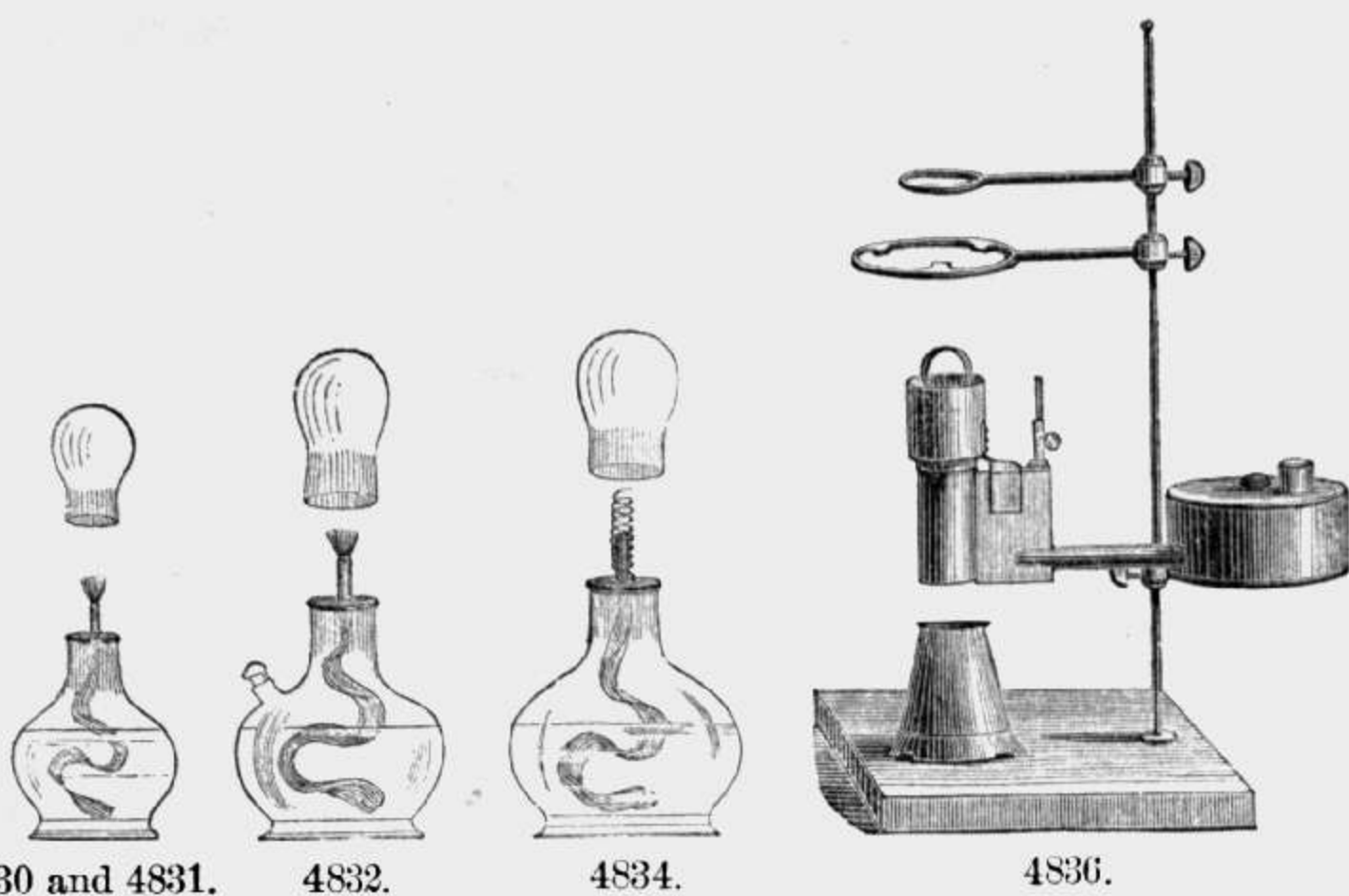

	PRICE
4830. Spirit Lamp, plain, of glass, with ground cap. Capacity two ounces..	\$0 50
4831. Spirit Lamp, same as No. 4830, but holding four ounces.....	75
4832. Spirit Lamp of glass, with ground cap, and aperture for filling without removing the wick. Capacity two ounces.....	1 25
4834. Aphlogistic Lamp, similar to No. 4831, but with coil of platinum wire	2 00
4835. Berzelius Lamp, of strong tin, neatly japanned.....	1 00
4836. Berzelius Lamp, of brass, with rack movement for the wick, and metal chimney, on stand.....	5 00
4842. Bunsen's Gas Burner, single tube without regulator.....	1 75
4843. Bunsen's Gas Burner, same as No. 4842, but with regulator for supply of air. ....	2 00
4844. Bunsen's Gas Burner, with air regulator, as No. 4843, and stop-cock for regulating the flow of gas.....	2 50
4845. Bunsen's Gas Burner, with key for adjusting the flow both of the air and the gas. Improved form.....	2 75
4846. Bunsen's Gas Burner, with three tubes and regulator for supply of air.	3 75
4847. Bunsen's Blast Lamp, for gas, with one pair of tubes for glass-blowing, melting metals, and any other intense heating, with stop-cock on each tube.....	8 00
4848. Bunsen's Blast Lamp, with 6 pairs of tubes, without stop-cocks.....	11 25
4849. Bunsen's Blast Lamp, same as No. 4848, but with 18 pairs of tubes.....	18 00
4850. Bunsen's Blast Lamp, arranged for hydro-oxygen light.....	10 00
4851. Hydro-oxygen Apparatus, complete. See Chapter XI.	



4847.

For Electric batteries, lamps, etc., for deflagration, etc., see Chap. VII., section IX.



SECTION II.—INSTRUMENTS WHICH ILLUSTRATE THE CHANGE OF VOLUME CAUSED BY HEAT.

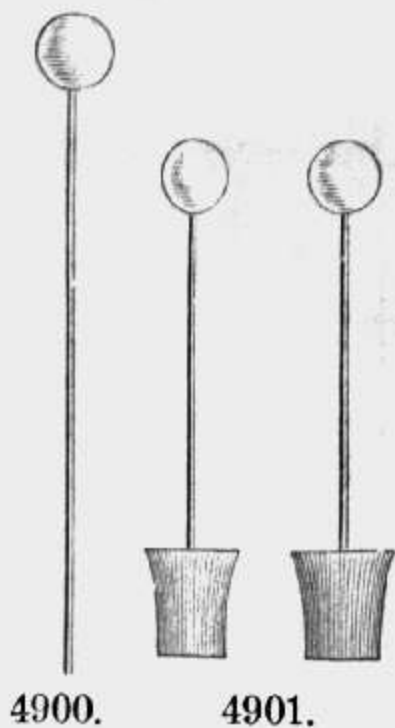

	PRICE
4900. <b>Air Thermometer.</b> Glass tube fifteen inches long, with bulb two inches in diameter.....	\$0 25
4901. Pair of Air Thermometers similar to No. 4900, with glass beakers...	1 00
4902. <b>Apparatus to show expansion of a liquid,</b> consisting of an air thermometer and glass beaker, with stand and holder.....	2 50
4903. <b>Apparatus to show comparative expansion of two liquids.</b> A pair of air thermometers on neat stands, one to be partly filled with colored water, the other with alcohol. A large glass beaker to be filled with hot water. For projection by lantern.....	5 00
4904. <b>Apparatus to show maximum density of water.</b> An air thermometer on stand, and a copper vessel for the freezing mixture. For projection by lantern.....	7 50
4905. <b>Apparatus for maximum density of water.</b> A glass cylinder twelve inches high, with a thermometer inserted horizontally near the top and another near the bottom. A jacket of copper to contain a freezing mixture surrounds the middle.....	11 00

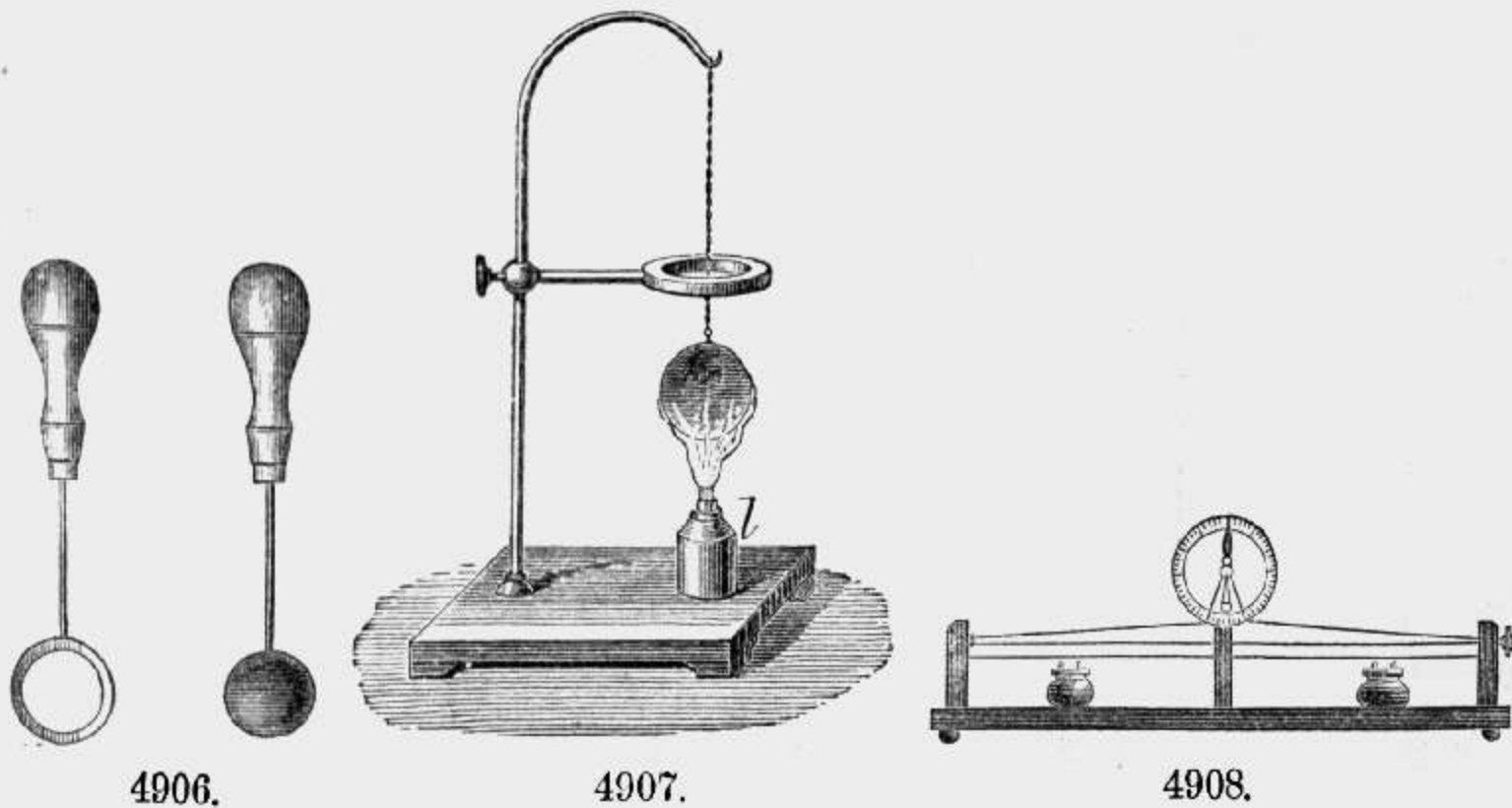

4906. <b>Ball and Ring</b> .....	2 50
4907. <b>Ball and Ring on stand,</b> with alcohol lamp.....	4 50
4908. <b>Pyrometer with two metals,</b> with lamps.....	7 50



	PRICE
4909. <b>Compound Bar.</b> To show the comparative expansion of two metals (brass and iron); twelve inches long, with a wooden handle.....	\$2 00
4910. <b>Compensating Pendulum.</b> Bars of brass and iron; small model.....	14 00
4911. <b>Compensating Pendulum.</b> Rod of brass with compensator of mercury.	25 00

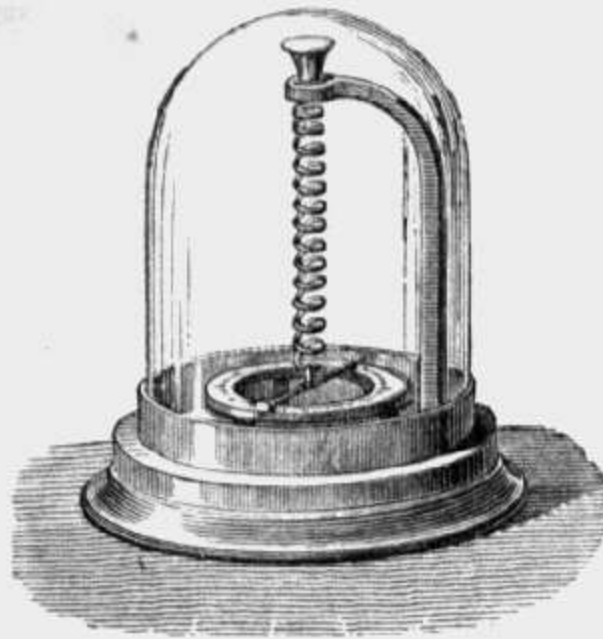

4913.

4912. <b>Wedgewood's Pyrometer</b> .....	15 00
4913. <b>Breguet's Metallic Thermometer</b> .....	40 00
4914. <b>Apparatus to show the Contraction of India-Rubber by Heat.</b> Consisting of a firm base of mahogany supporting a rod of iron with clamps and arms for attaching the India-Rubber, and surrounding it with a sheet-iron tube; and also a post with a lever of very long light arm suspended upon it as a fulcrum, and held down at one end by a spiral spring. A weight of ten pounds and an alcohol lamp complete the arrangement. See Tyndall's Lectures.....	20 00
4915. <b>Geyser Illustration.</b> Consisting of a galvanized iron tube six feet long, surmounted by a basin of the same material two and a half feet in diameter. The whole instrument is mounted upon a tripod, and heated at the bottom, and two feet above it, by two charcoal furnaces. A series of stops and cocks permits the operator to illustrate various intermittent geyser actions.....	25 00

SECTION III.—THERMOMETERS.

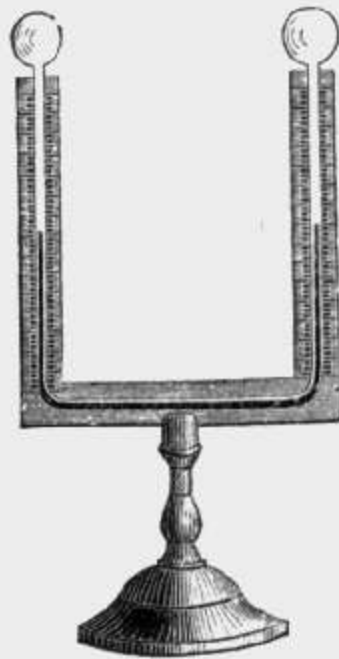

4926.

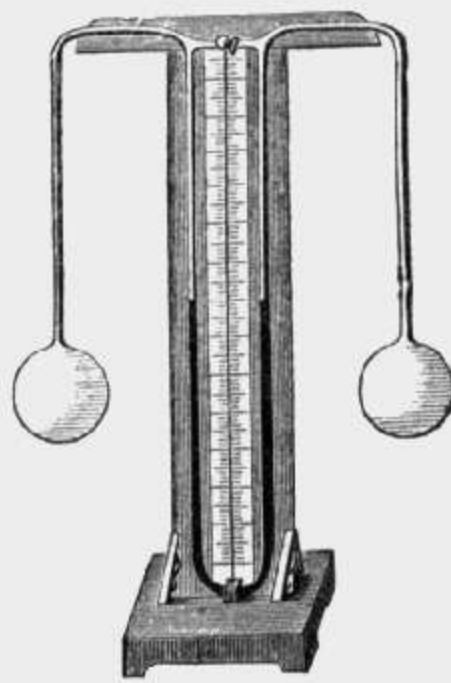

4927.

THERMOMETERS.

57

	PRICE
4925. <b>Leslie's Differential Thermometer on stand</b> .....	\$3 00
4926. <b>Leslie's Differential Thermometer, on mahogany stand, with scale on both arms</b> .....	5 00
4927. <b>Matthiessen's Differential Thermometer.</b> A short tube with clamps connects the upright tubes near the top, and permits the pressure, <i>i e.</i> , the <i>temperature</i> of the two arms to be speedily equalized. All mounted upon a neat mahogany stand with scale.....	15 00
4928. <b>Matthiessen's Differential Thermometer.</b> With <i>glass</i> upright and scale to permit use in the lantern for projection. The position of the bulbs in this form of the differential thermometer gives it a great advantage over the old form, and when used for projection it dispenses in many cases with the more delicate thermo-multiplier No. 4964.....	17 50

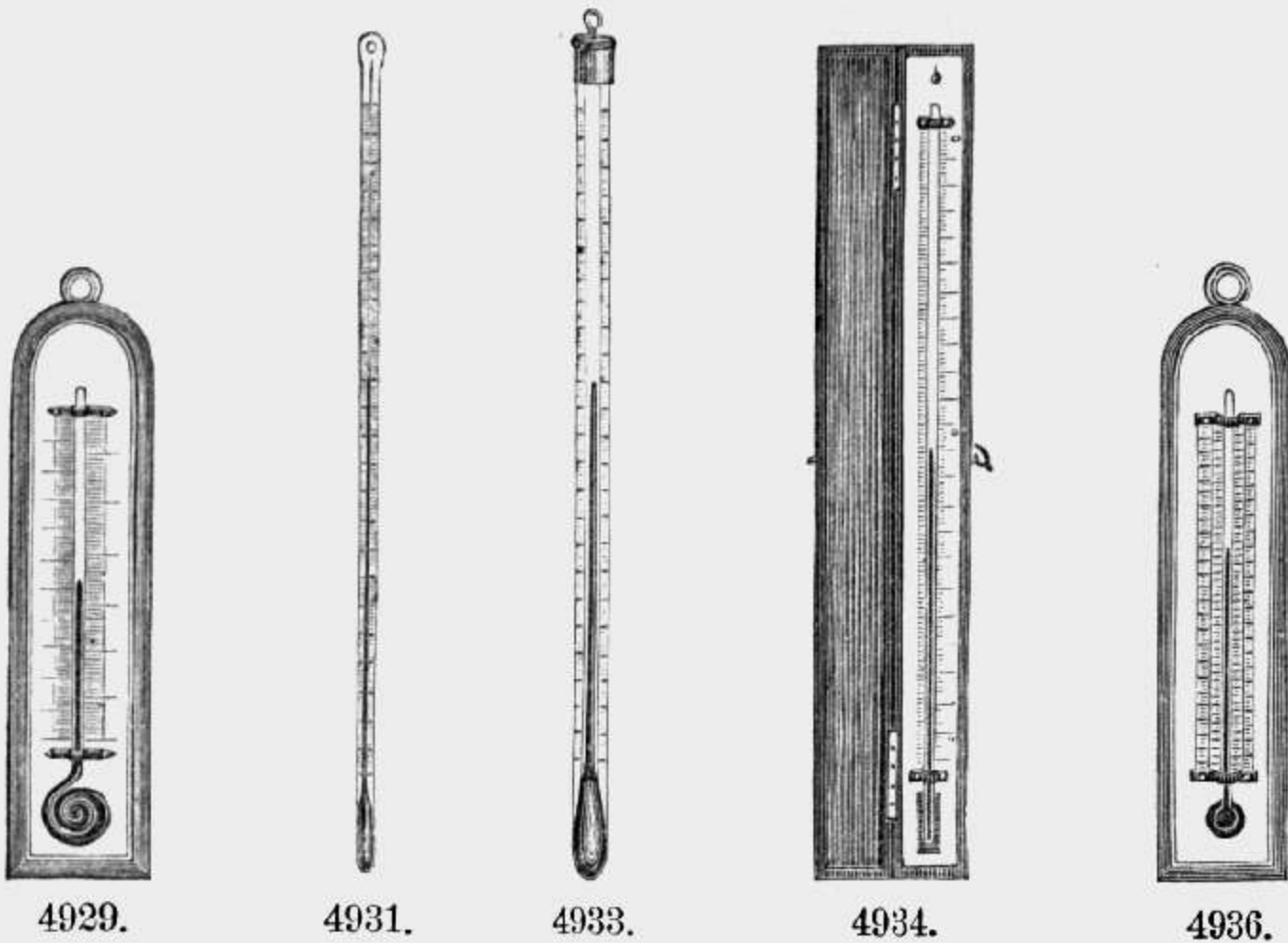

4929. <b>Alcohol Thermometer</b> , ten inches long, with spiral bulb ; $40^{\circ}$ to $+130^{\circ}$ .	2 50
4931. <b>Mercurial Thermometer</b> , graduated on the tube and reading to $300^{\circ}$ , in wood case.....	3 50
4932. <b>Mercurial Thermometer</b> , thirteen inches long, graduated on the tube and reading to $600^{\circ}$ ; in wood case.....	4 00
4933. <b>Mercurial Thermometer</b> , reading to fifths of a degree, inclosed in a glass tube with porcelain scale, and furnished with a brass cap and hook for suspension ; eighteen inches long.....	11 00
4934. <b>Normal or Standard Thermometer.</b> 24 inches long, divided upon tube to fifths of a degree, from $0^{\circ}$ to $110^{\circ}$ Centigrade, in a neat morocco case.....	12 50
4935. <b>Normal or Standard Thermometer</b> , engraved upon the tube, from $-40^{\circ}$ to $+220^{\circ}$ Fahrenheit ; in neat case.....	15 00
4936. <b>Comparative Thermometer</b> , eight inches long, carrying the three scales, Centigrade, Reaumur, and Fahrenheit.....	4 50
4937. <b>Comparative Thermometer</b> , similar to No. 4936, but with the scales engraved upon glass to permit of projection upon a screen by the lantern.....	5 50





4938.



4939.



4940.



4941.

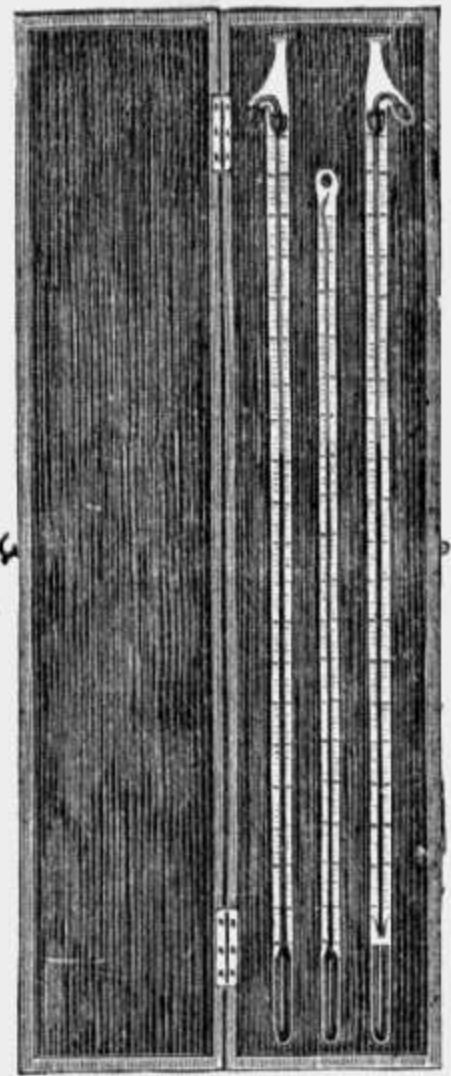

4942.

PRICE

- |  |         |
|--|---------|
| 4938. <b>Metastatic Thermometer of Walferdin</b> , 16 inches long, to measure very small differences of temperature anywhere between the freezing-point and the boiling-point of mercury.....                    | \$12 50 |
| 4939. <b>Metastatic Differential Thermometer of Walferdin</b> , 13 inches long, containing alcohol instead of mercury, and of course showing slighter differences of temperature than is possible with mercury.. | 12 50   |
| 4940. <b>Maximum Thermometer of Walferdin</b> , divided upon the tube.....   | 12 50   |
| 4941. <b>Minimum Thermometer of Walferdin</b> , divided upon the tube.....   | 12 50   |
| 4942. <b>Maximum Thermometer and Minimum Thermometer of Walferdin</b> , Nos. 4940 and 4941, with Normal Thermometer No. 4934, inclosed in a neat morocco case.....   | 35 00   |
| 4943. Same as No. 4942, without the Standard Thermometer.....  | 25 00   |



4950.



4952.

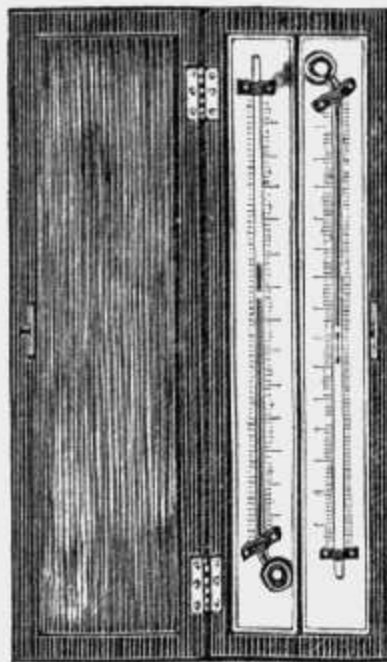

4954.



4958 and 4959.

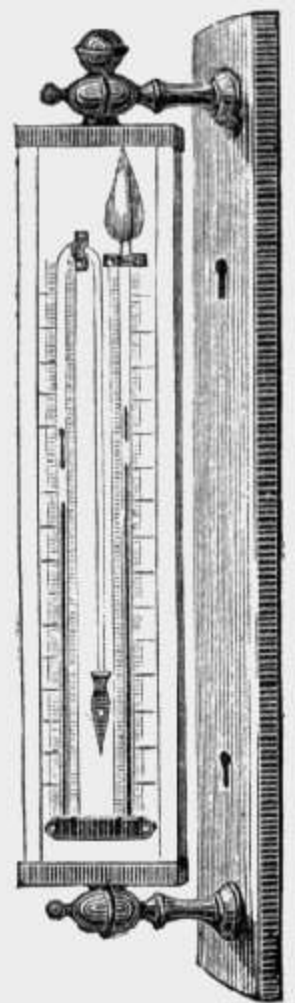

4960



	PRICE
4950. <b>Minimum Thermometer of Rutherford</b> , Fahrenheit, twelve inches long, mounted upon a plate of porcelain, with scale.....	\$10 00
4951. Minimum Thermometer of Rutherford, twelve inches long, divided upon the tube to fifths of a degree, centigrade, in case.....	7 50
4952. <b>Maximum Thermometer of Negretti and Zambra</b> , mounted upon a porcelain plate with scale Fahrenheit.....	10 00
4953. Maximum Thermometer of Negretti and Zambra, divided upon the tube to fifths of a degree, centigrade, in neat case.....	10 00
4954. Minimum Thermometer, No. 4950, and Maximum Thermometer, No. 4952, in neat morocco case, seven inches long.....	10 00
4955. Same as 4954, but ten inches long.....	14 00
4958. <b>Six's Maximum and Minimum Thermometer</b> , scale eight inches long, mounted in painted tin case, with roof, for protection from sun and weather.....	7 50
4959. Six's Maximum and Minimum Thermometer. Similar to No. 4958, but with scale fourteen inches long.....	10 50
4960. Six's Maximum and Minimum Thermometer. 18 inches long, mounted on a porcelain plate. The plate with the thermometers turns upon pivots in the ends, and is fastened by two arms to a strong oak back, to render it available as a <i>window</i> thermometer.....	18 00

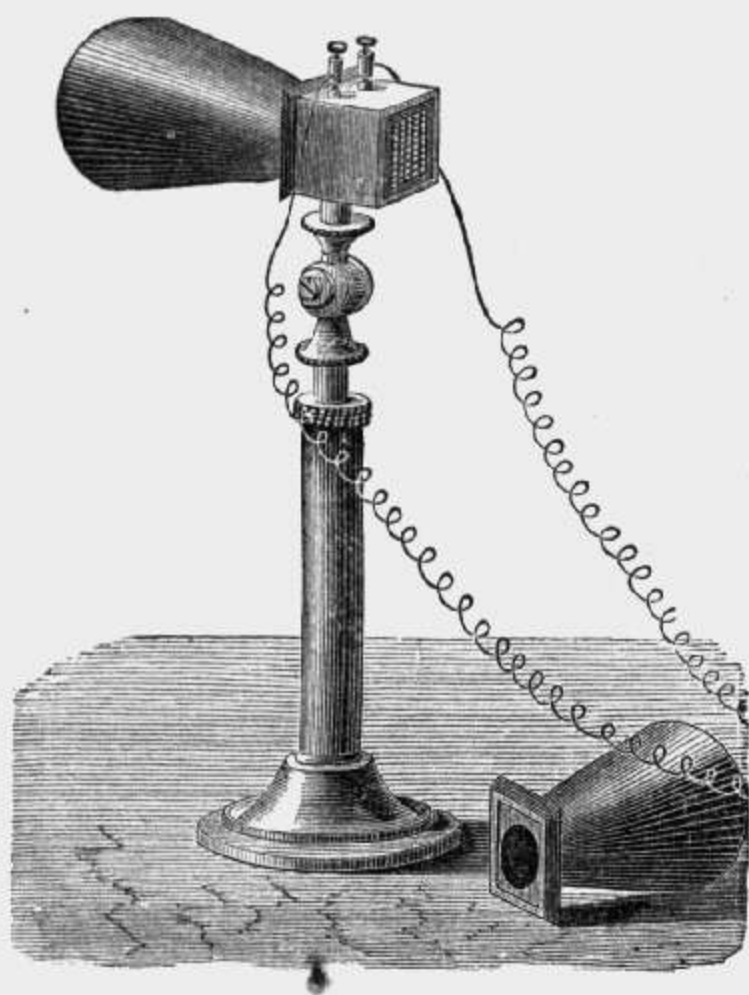

4964 to 4966.

4964. Thermo-Multiplier. Twenty-five pairs of bismuth and antimony, in brass case, with elevating and adjusting stand, clamp, caps, and cones.....	30 00
4965. Thermo-Multiplier. Similar to No. 4964, but with thirty-six pairs....	45 00
4966. Thermo-Multiplier. Similar to No. 4964, but with forty-nine pairs..	60 00

For Galvanometer, see Electricity ; Chapter VII, Nos. 5540 and 5543.

## SECTION IV.—OF ABSORPTION, RADIATION, REFLECTION, REFRACTION, AND POLARIZATION.

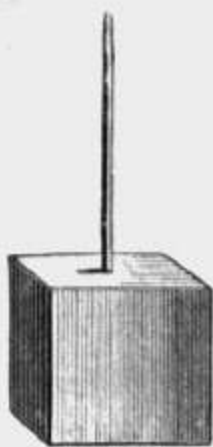

4975.

- |  | PRICE  |
|--|--------|
| 4975. <b>Leslie's Radiator.</b> Pair of cubes 3 inches on a side, of different colors on different sides, with a cover, and a vertical thermometer.  | \$3 00 |
| 4980. <b>Apparatus to show that radiant heat varies inversely as the square of the distance.</b> Used with the thermo-multiplier, Nos. 4964, '65 and '66. It consists of a flat tin vessel for water, twenty-four inches square, with one side blackened; mounted upon a stand of cast-iron, and kept at a boiling temperature by a lamp or Bunsen's burner. Without lamp, or Bunsen's burner..... | 15 00  |
| 4981. <b>Pair of Parabolic Reflectors,</b> of planished tin, thirteen inches in diameter, with elevating stands, ball and phosphorus cup.....  | 9 00   |

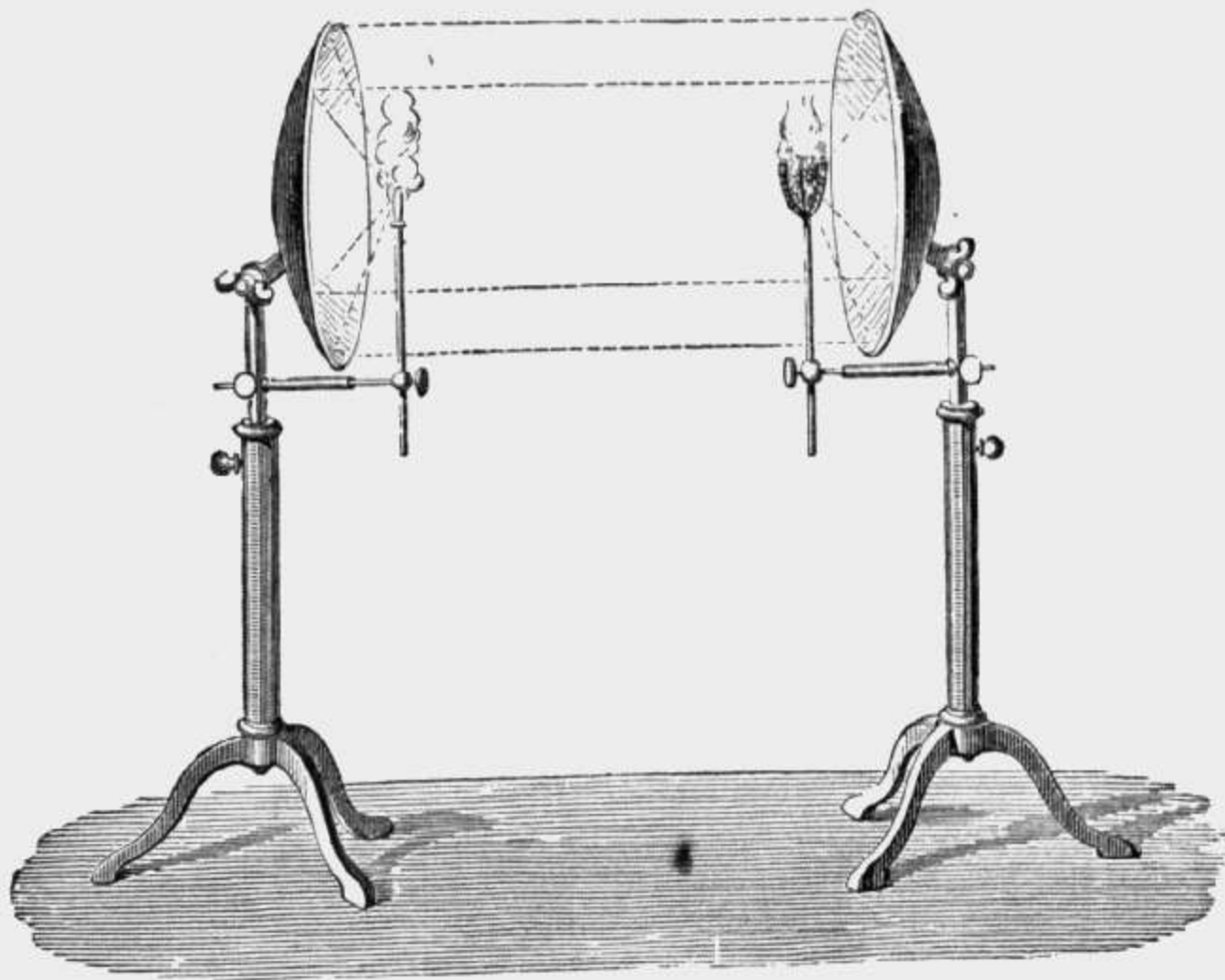

4983.

- |   |       |
|---|-------|
| 4982. <b>Pair of Parabolic Reflectors,</b> of copper, nickel plated, thirteen inches in diameter, mounted upon elevating and adjusting stands of mahogany and brass, with ball and holder, and phosphorus cup. Made exceedingly accurate..... | 50 00 |
| 4983. <b>Pair of Parabolic Reflectors,</b> of silvered copper, twenty inches in diameter, mounted upon mahogany and brass elevating and adjusting stands, with ball and holder, and phosphorus cup.....                                       | 75 00 |



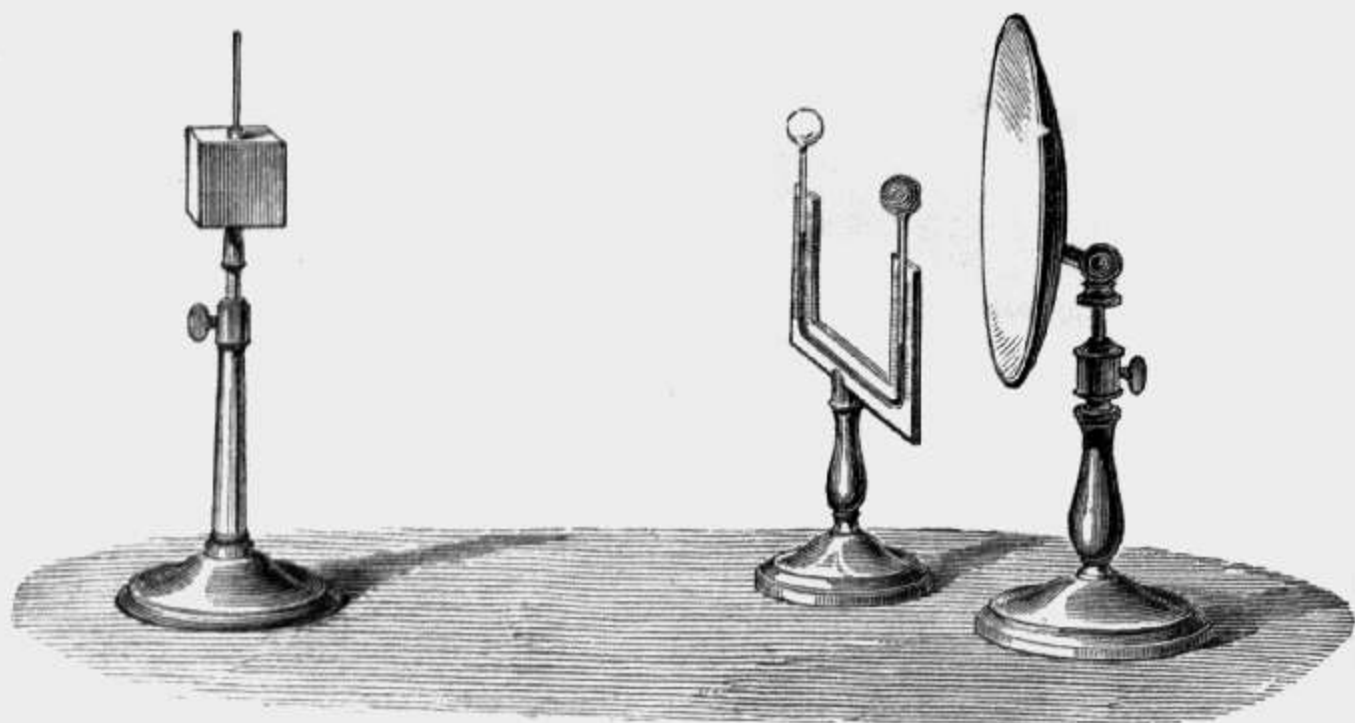

4984 and 4985.

- |   | PRICE   |
|---|---------|
| 4984. <b>Apparatus to Illustrate both Radiation and Reflection.</b> Consisting of a Leslie's cube, on adjusting stand of mahogany, a Leslie's differential thermometer, and a parabolic reflector, thirteen inches in diameter of planished tin, on a neat adjusting stand of mahogany..... | \$12 50 |
| 4985. Apparatus, same as No. 4984, but with parabolic reflector of nickel-plated copper, thirteen inches in diameter .....  | 24 00   |

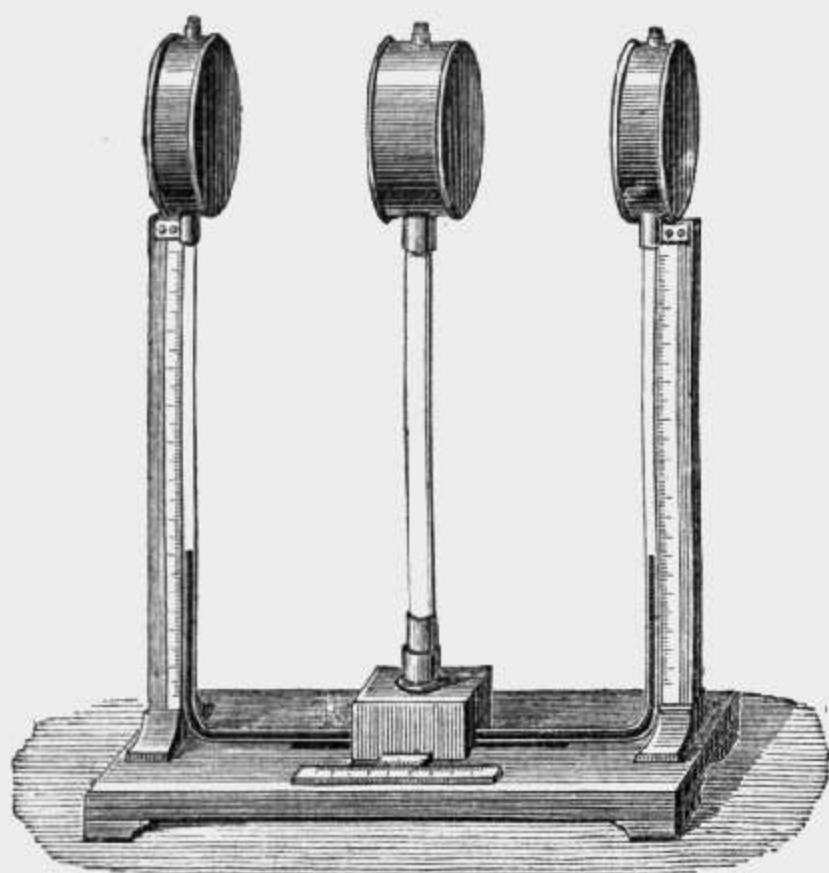

4986.

- |  |       |
|--|-------|
| 4986. <b>Ritchie's Apparatus.</b> To show the relation of radiation and absorption. Consisting essentially of a differential thermometer, with reservoirs of metal, the face of one black with lampblack, that of the other covered with white paint. A stand carrying a cylindrical vessel is placed between the arms, and can be adjusted to any desired position. This vessel is filled with hot water, and has its face, which is opposite the reservoir with blackened face, covered with white paint, and that opposite the one covered with white paint blackened with lampblack. Thus, the radiation from the black surface is absorbed by the white, and vice versa ..... | 25 00 |
| 4987. <b>Burning Mirror,</b> of silvered glass, six inches in diameter, mounted on pivots on a brass frame, with a holder for the substances to be melted.   | 30 00 |
| 4990. <b>Lens of Glass,</b> six inches in diameter, to show refraction of heat; on a brass stand.....  | 10 00 |
| 4991. <b>Lens,</b> similar to No. 4990, but eight inches in diameter .....   | 13 00 |



	PRICE
4992. <b>Pair of Lenses</b> , four and a half inches in diameter, of short focus, mounted in brass cell, to be used with the oxyhydrogen or electric lamp, to show refraction of heat.....	\$16 00
4993. <b>Hollow Prism of Glass</b> , for bisulphide of carbon, to show refraction and dispersion of heat; large model.....	7 50
4994. <b>Solid Prism of Rock Salt</b> , for same purpose, in a neat case.....	10 00

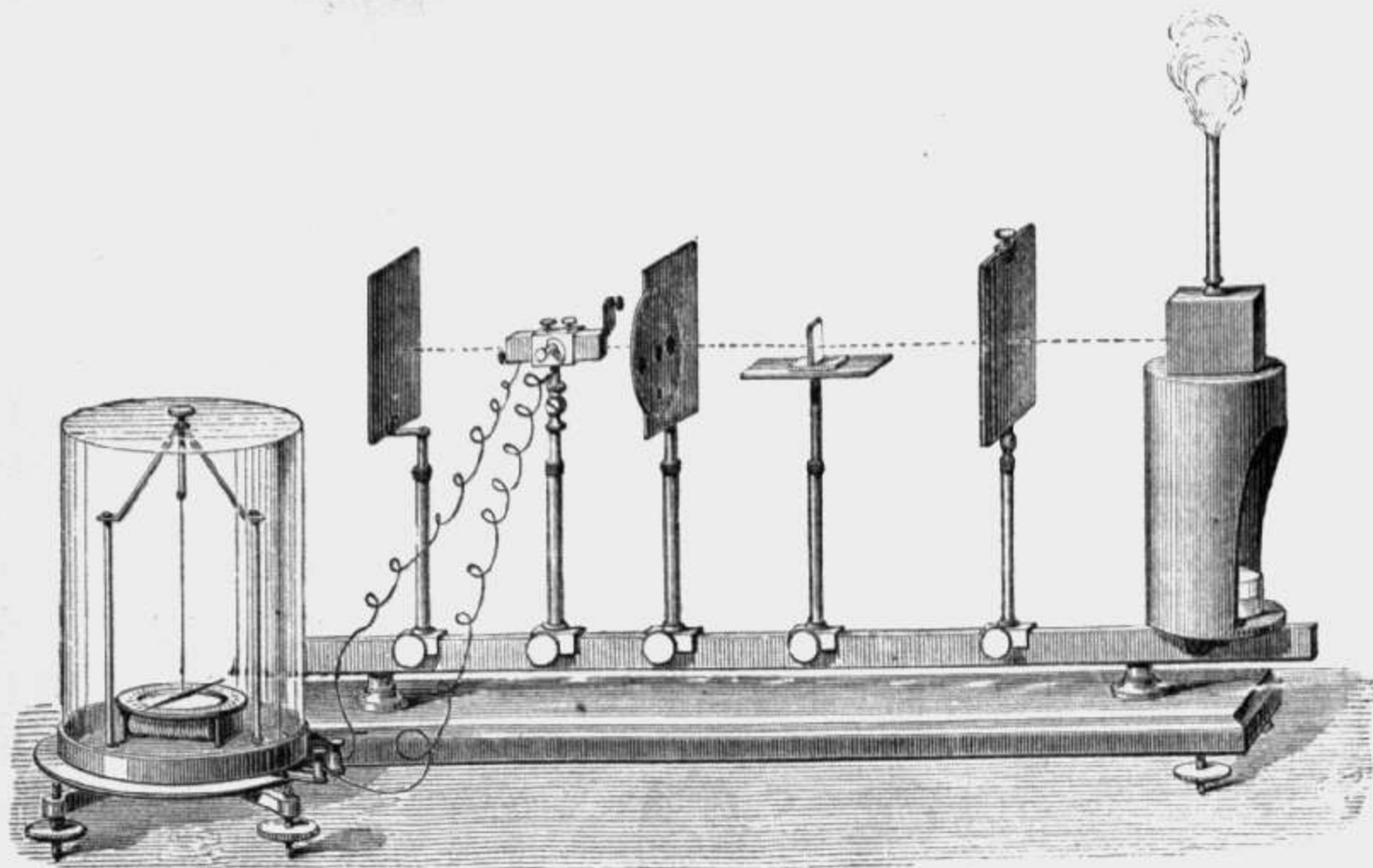

4995.

4995. **Melloni's Apparatus** for determining the laws of radiant heat, and the dia-thermancy of bodies.

This instrument consists of a graduated bar of brass, on a finely polished wooden base, with leveling screws; and carrying on elevating and adjusting posts of brass the following parts:

1. A Leslie's Cube, with shield and lamp.
2. Three screens, for cutting off and limiting the amount of heat.
3. A table to carry the body whose dia-thermancy is to be tested.
4. A thermo-multiplier, No. 4964.

A delicate galvanometer, with leveling screws, accompanies the table.

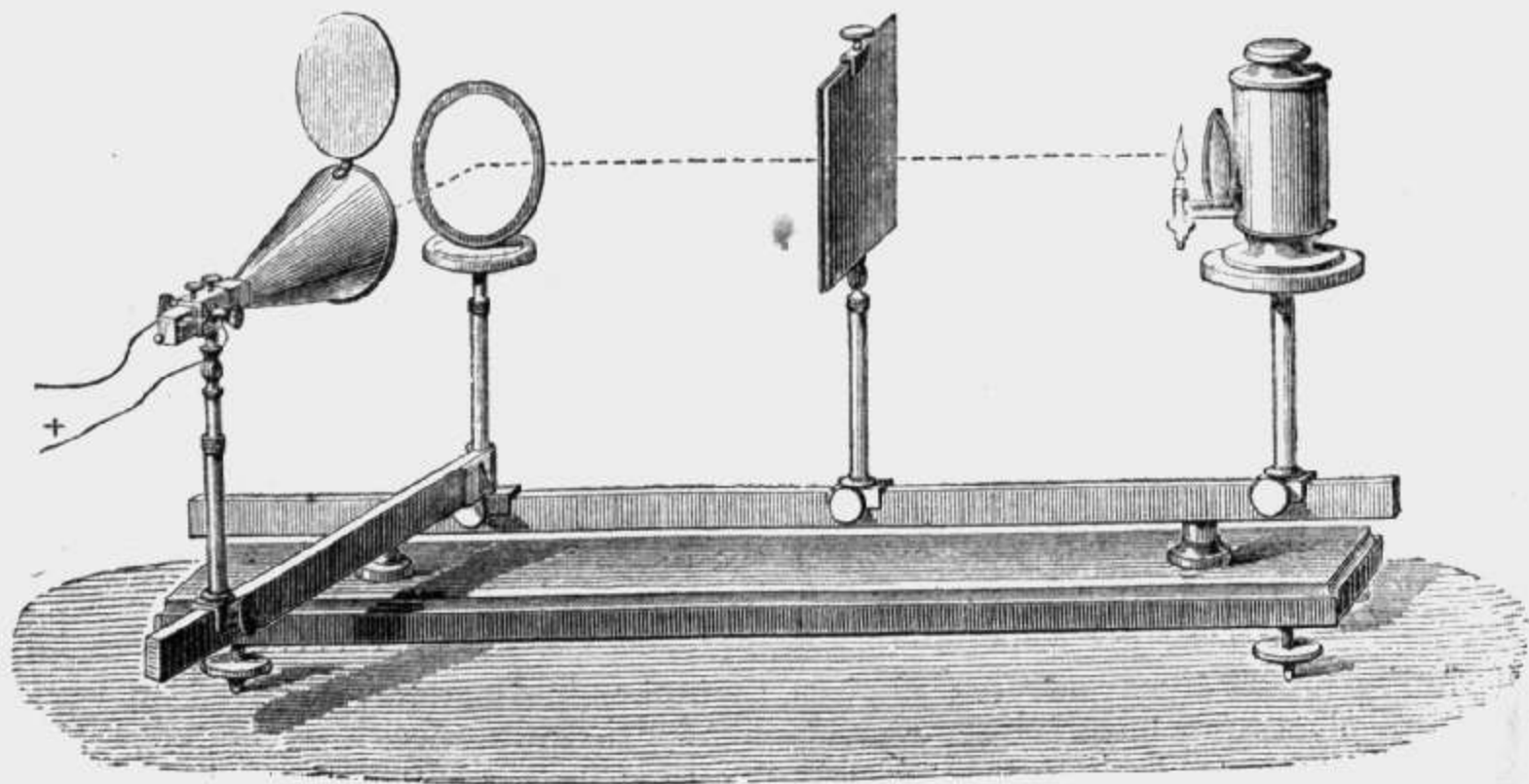

4996.

4996. **Melloni's Apparatus** for illustrating the laws of reflection, refraction, and diffusion. Consisting of the following additions to No. 4995:

1. A graduated arm of brass connected with the main bar of No. 4995 by a pivot and clamp.
2. A Locatelli lamp on stand.
3. A double screen on stand.
4. A stand with circular table graduated on the margin.
5. A silver reflector, burnished upon one side, but left unburnished upon the other.
6. A hollow prism for bisulphide of carbon.

Fig. 4996 shows the mode of arranging the thermo-multiplier and reflector.

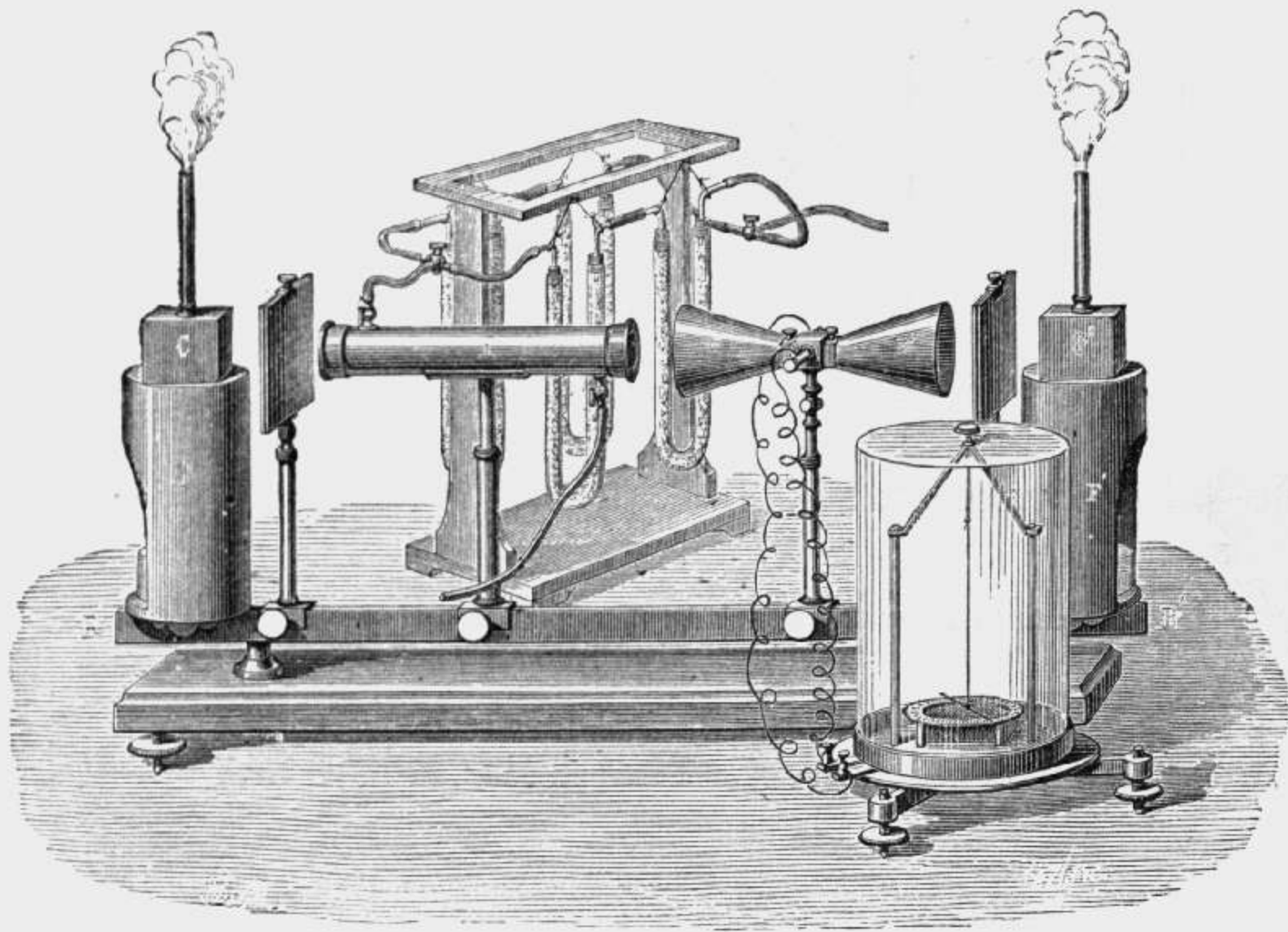

4997.

4997. **Tyndall's Addition to Melloni's Apparatus.** Consisting of a brass tube, with caps of rock salt, and entrance and exit tubes for gases; a series of four U tubes with the necessary stop-cocks, mounted on a neat mahogany frame, and an additional Leslie's cube, with clamp and shield, and a double screen. The mode of using is shown in the cut.....

\$85 00



5000.

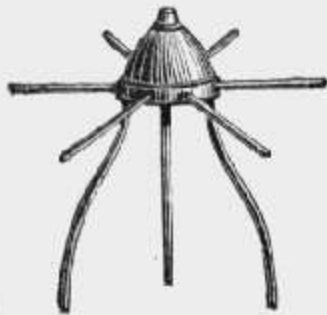

5001.

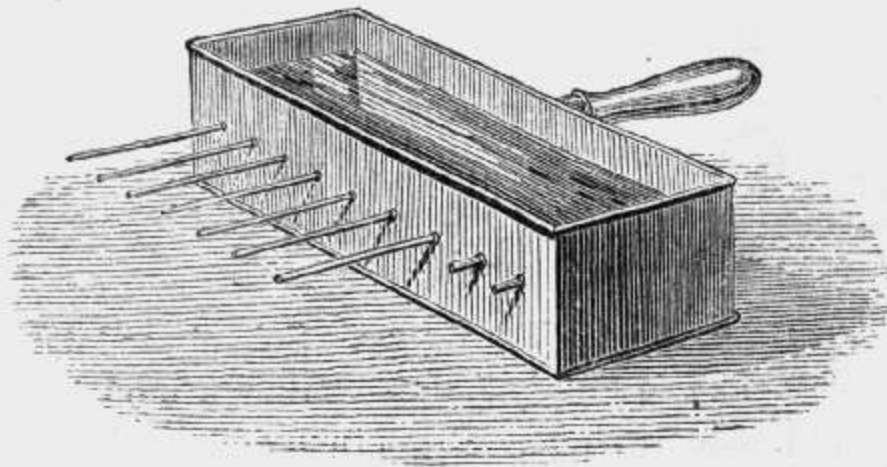

5002



	PRICE
5000. <b>Conductometer.</b> Brass disc, with wooden handle, and six bars of different material, with cups for phosphorus.....	\$2 50
5001. <b>Conductometer.</b> Brass disc, on tripod stand, with six bars of different material, with cups and a lamp for heating.....	4 50
5002. <b>Conductometer of Ingenhouse.</b> A tank of tin, fifteen inches long, three wide and two deep, with nine flanges, and rods of different substances, and cups for phosphorus.....	7 50
5003. <b>Jamin's Ingenhouse Conductometer.</b> Similar to No. 5002, but with cover, feet and lamp.....	12 50



5004.

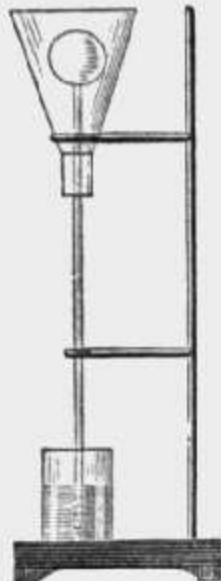

5005.

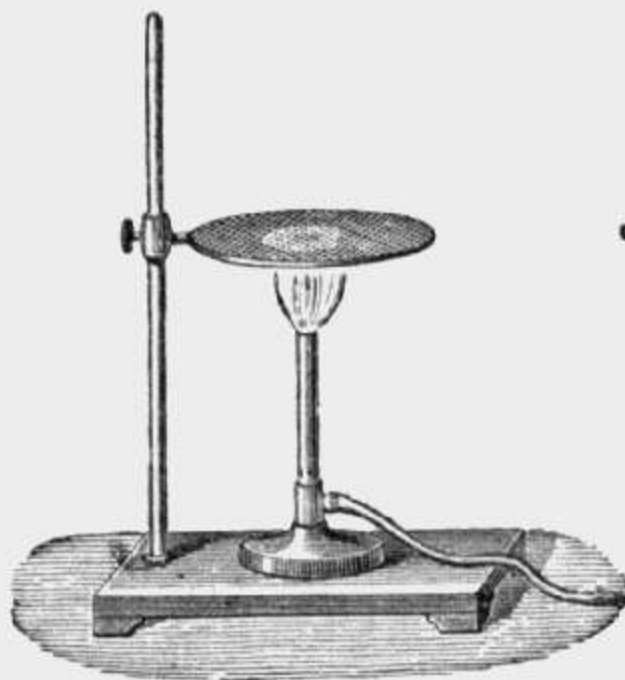

5008.



5004. <b>Apparatus to show the Weak Conducting Power of Water.</b> Glass funnel, air thermometer, and glass beaker.....	1 50
5005. Apparatus, &c., same as No. 5004, but mounted on neat stand.....	3 50
5007. <b>Wire Gauze.</b> Four inches square, with handle.....	75
5008. <b>Wire Gauze.</b> Four inches in diameter, on stand, with Bunsen burner.	3 75



5011.



5012.

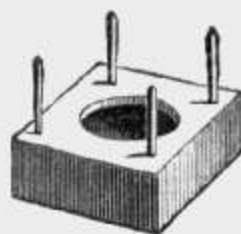

5113.



5114.

5009. <b>Davy's Safety Lamp.</b> School model.....	12 00
5010. <b>Day's Safety Lamp.</b> Miner's model.....	15 00
5011. <b>Air Syringe.</b> Brass tube and piston, with box of tinder.....	3 00
5012. <b>Air Syringe.</b> Strong glass tube and piston, with box of tinder.....	6 50



INSTRUMENTS ILLUSTRATING THE PHENOMENA OF VAPORIZATION. 65

	PRICE
5013. <b>Set of Boxwood Moulds</b> , to use in showing the phenomenon of rege- lation. Spherical, cylindrical, and lenticular forms.....	\$6 00
5014. <b>Cast-Iron Bottles</b> . With screw top, to show the expansive power of water in freezing. Each.....	4 00

SECTION V.—OF INSTRUMENTS ILLUSTRATING THE PHENOMENA  
VAPORIZATION.

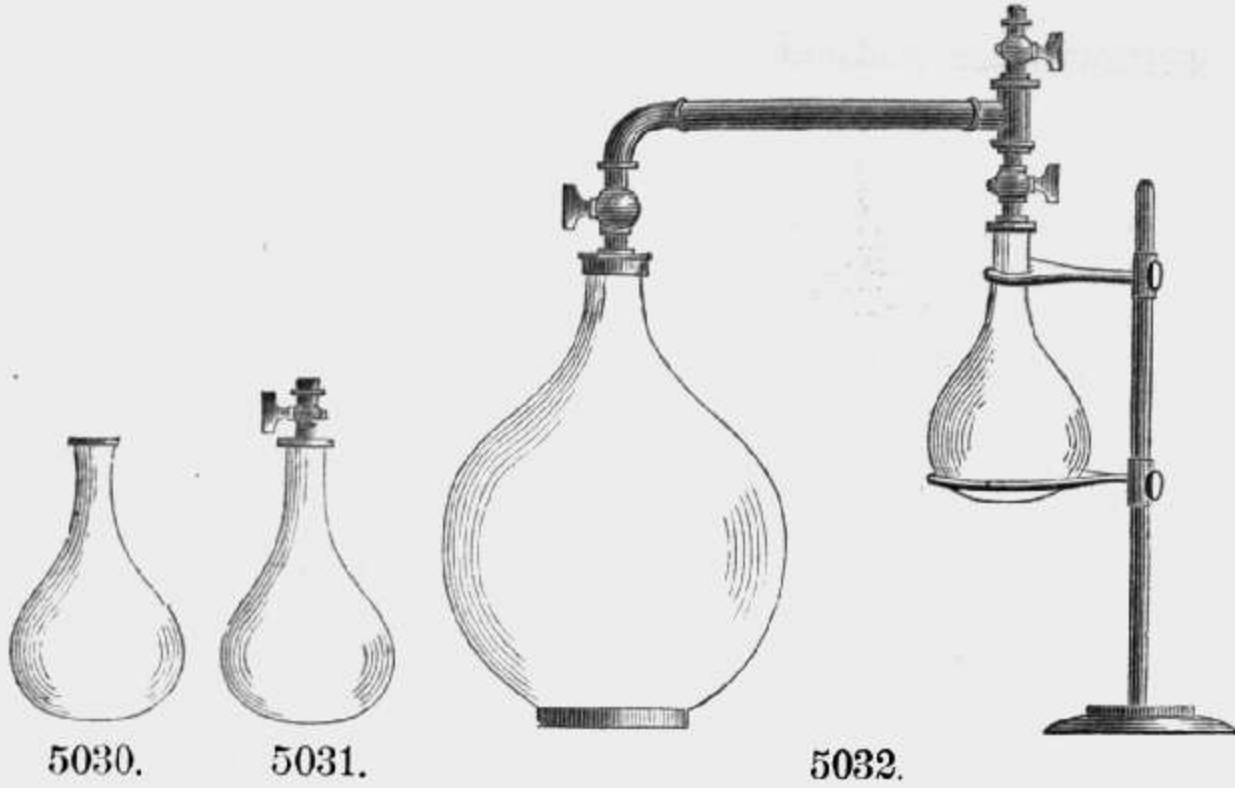

5030. <b>Culinary Paradox</b> . A glass flask, capacity one quart, with cork....	60
5031. <b>Culinary Paradox</b> . A glass flask, capacity one quart, with brass cap and stop-cock.....	3 50
5032. <b>Culinary Paradox</b> . A glass flask, with brass cap and stop-cock. A larger flask is connected with this by a metal tube, and a pair of stop- cocks, placed as shown in the cut, permits the large flask to be ex- hausted by the air-pump.....	15 00

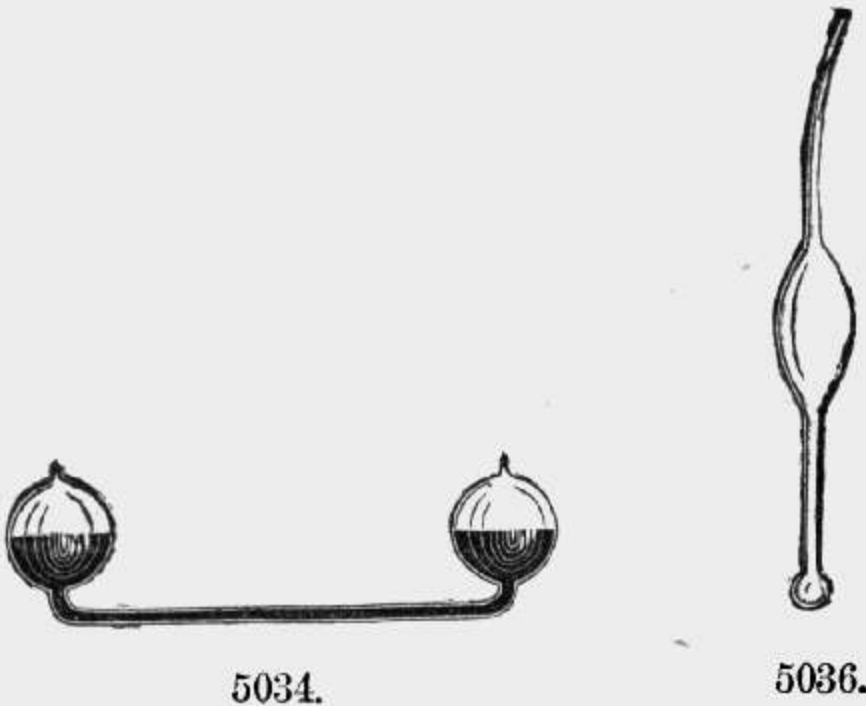

5033. <b>Palm Glass</b> .....	75
5034. <b>Franklin's Pulse Glass</b> .....	75
5035. <b>Pulse Glass</b> , with straight stem.....	75
5036. <b>Eolipile</b> , or Ether Jet. Of glass.....	40
5037. <b>Cryophorus</b> .....	2 00

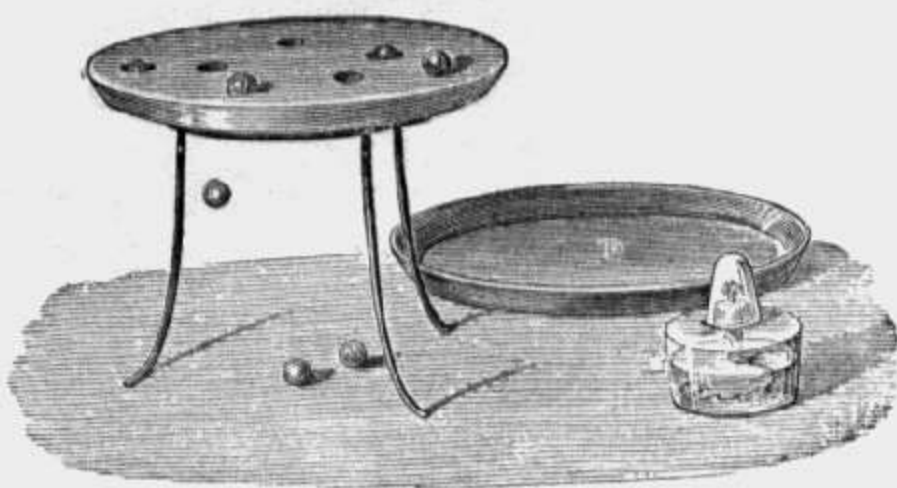

5038.

**5038. Tyndall's Apparatus for Specific Heat.** Consisting of a metal stand and ring for supporting a plate of wax. A dish for moulding the wax, and a lamp for melting it, two cakes of wax, three-eighths of an inch in thickness, and a series of seven balls, accompany the instrument.....

PRICE

\$7 50

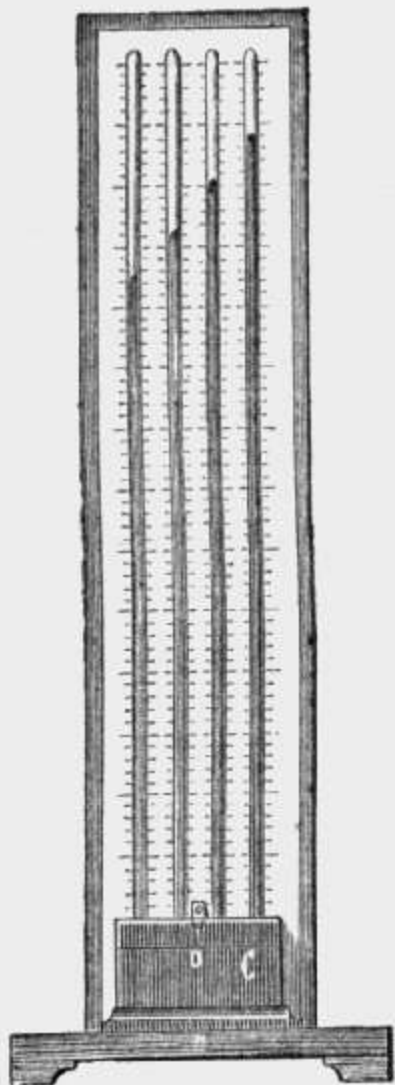

5041.

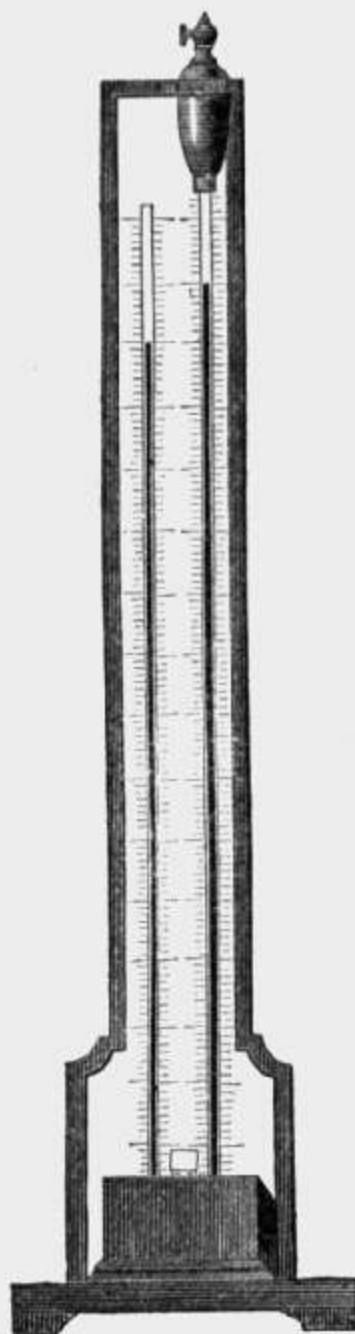

5043.

**5041. Apparatus to show the Unequal Tension of Different Vapors.** A cistern of iron, and four strong barometer tubes of glass, securely mounted upon a mahogany frame.....

18 00

5042. **Barometer, with deep Cistern**, to show that the Law of Mariotte applies to Non-saturated Vapors. Cistern of iron, with glass top, mounted on a neat iron tripod. An ordinary barometer tube supported from one side of the tripod stand, is attached..... \$12 50
5043. **Apparatus of M. Pouillet**, to show that the Tension of Vapor increases with the degree of saturation. A vase of iron for mercury, an ordinary barometer tube of glass, and a second tube, to the upper end of which a metallic vessel, with stop-cock, is cemented. All securely fastened to a neat, but strong stand of wood..... 27 50

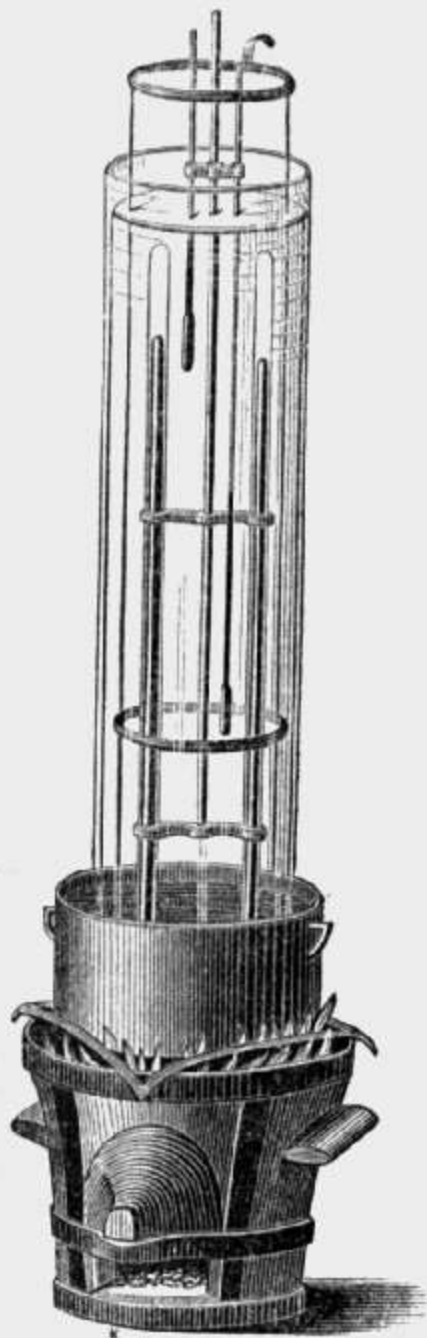

5045.

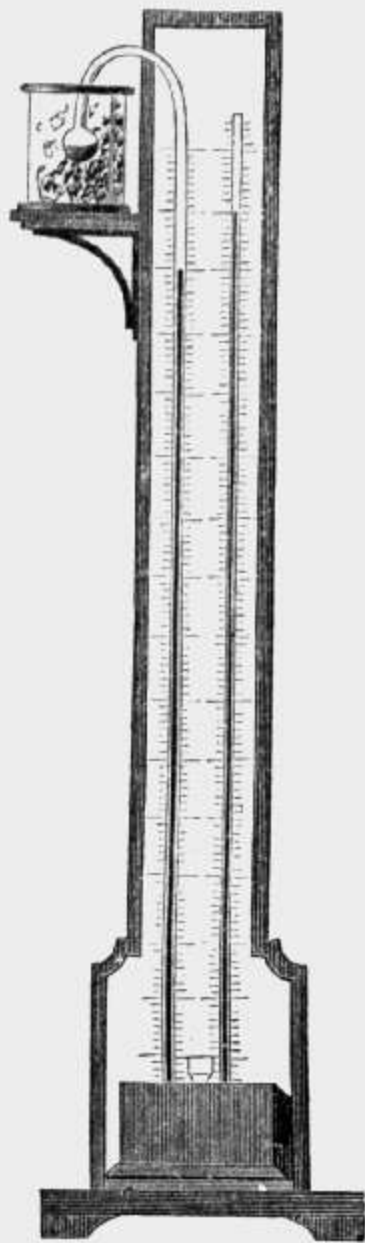

5046.

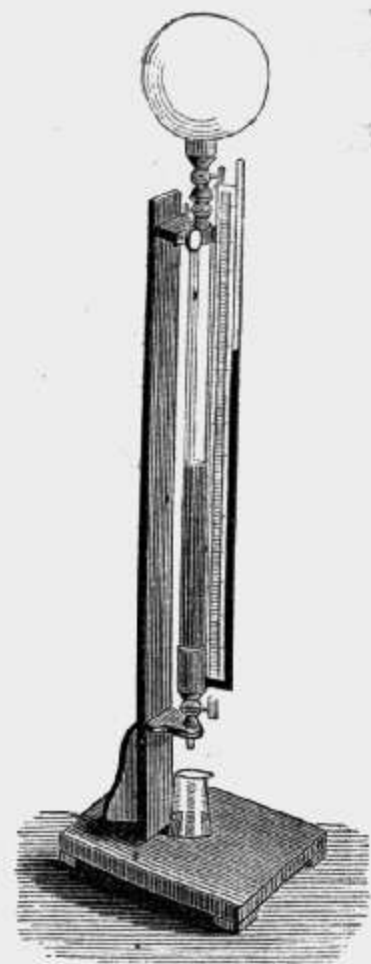

5047.

5045. **Dalton's Apparatus.** To measure the tension of the vapor of water between  $0^{\circ}$  and  $212^{\circ}$ . Consists of an iron reservoir for mercury, a glass tube three or four inches in diameter, and thirty-six inches high, for water; two barometer tubes, and two thermometers, on a strong frame. The whole is supported by a stout frame, and rests on a strong furnace for charcoal; or on a heavy iron base when Bunsen burners supply the place of a furnace. With the furnace.. 48 00
5046. **Gay Lussac's Apparatus.** To measure the tension of the vapor of water below  $0^{\circ}$ . Consisting of an iron reservoir for mercury, and two strong glass barometer tubes, supported on a neat mahogany frame. One of these is an ordinary tube, the other is recurved at the upper end, and terminates in a ball, which is surrounded, in performing the experiment, with a freezing mixture..... 27 00



5047. **Apparatus of Gay Lussac and Thenard.** To measure the tension of vapors mingled with gases.....

PRICE  
\$48 00

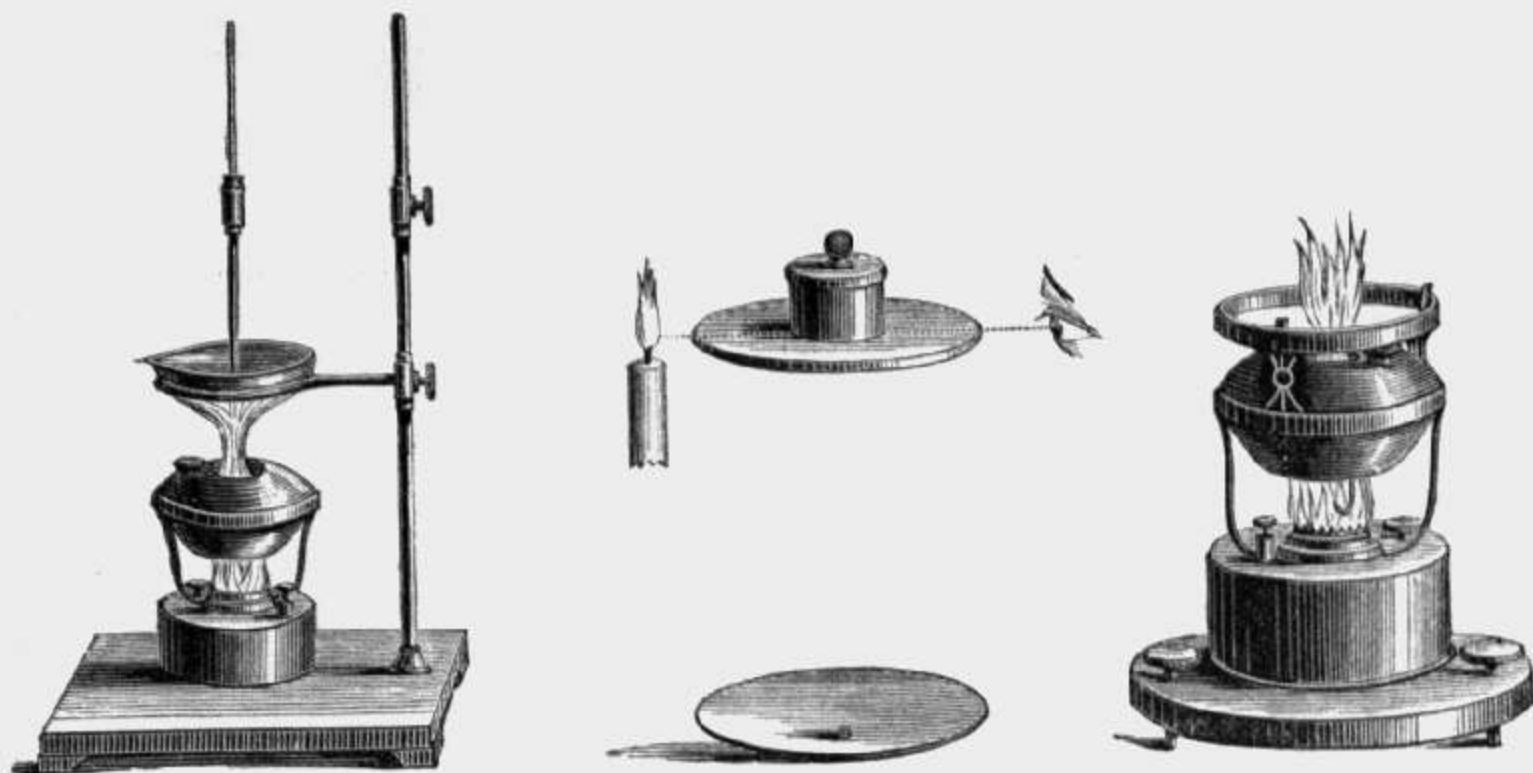

5055.

5055. **Apparatus of M. Boutigny.** For experiments upon the spheroidal state of liquids. Consisting of a blast-lamp with vertical jet, on a table, with leveling screws, and a table to hold the various plates, etc., as follows:

1. A silvered plate slightly hollowed.
2. A silvered cup, pierced with small holes.
3. A silvered plate, perfectly plain, and a silvered cylinder, cut away on opposite sides at one end.
4. A silvered basin, furnished with a thermometer, to show the temperature of the fluid during the spheroidal state.....

50 00

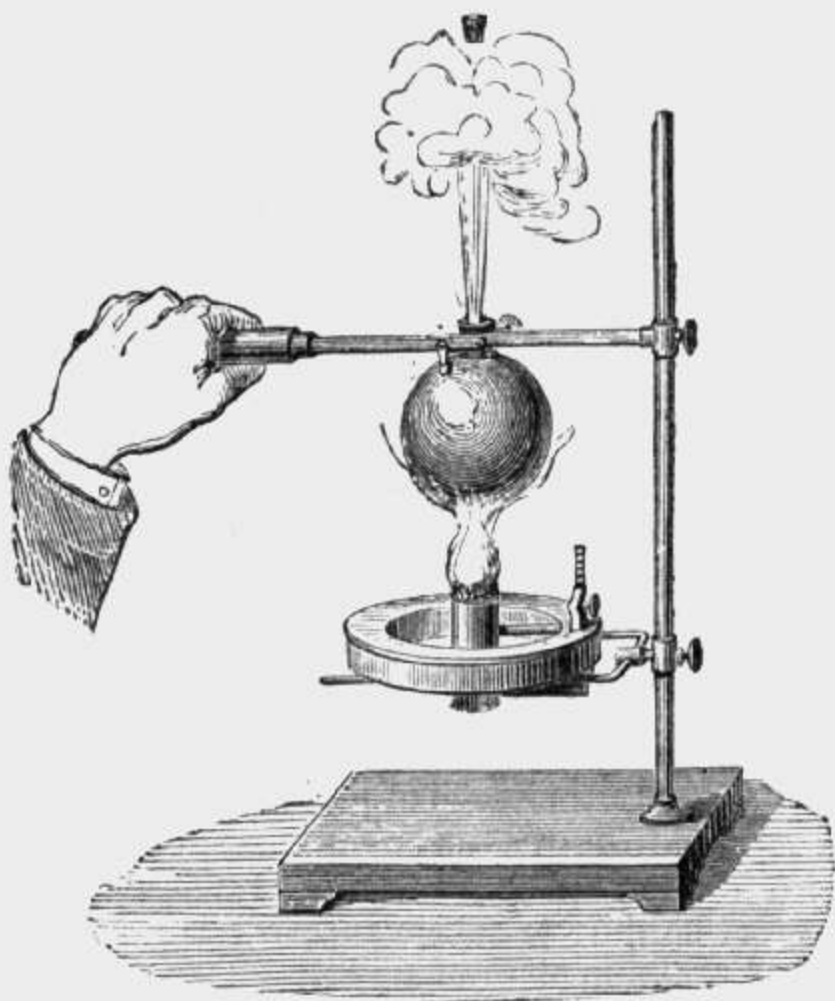

5056.

5056. **Copper Vessel,** to show spheroidal state. With lamp supported on stand as shown in the cut.....

12 50

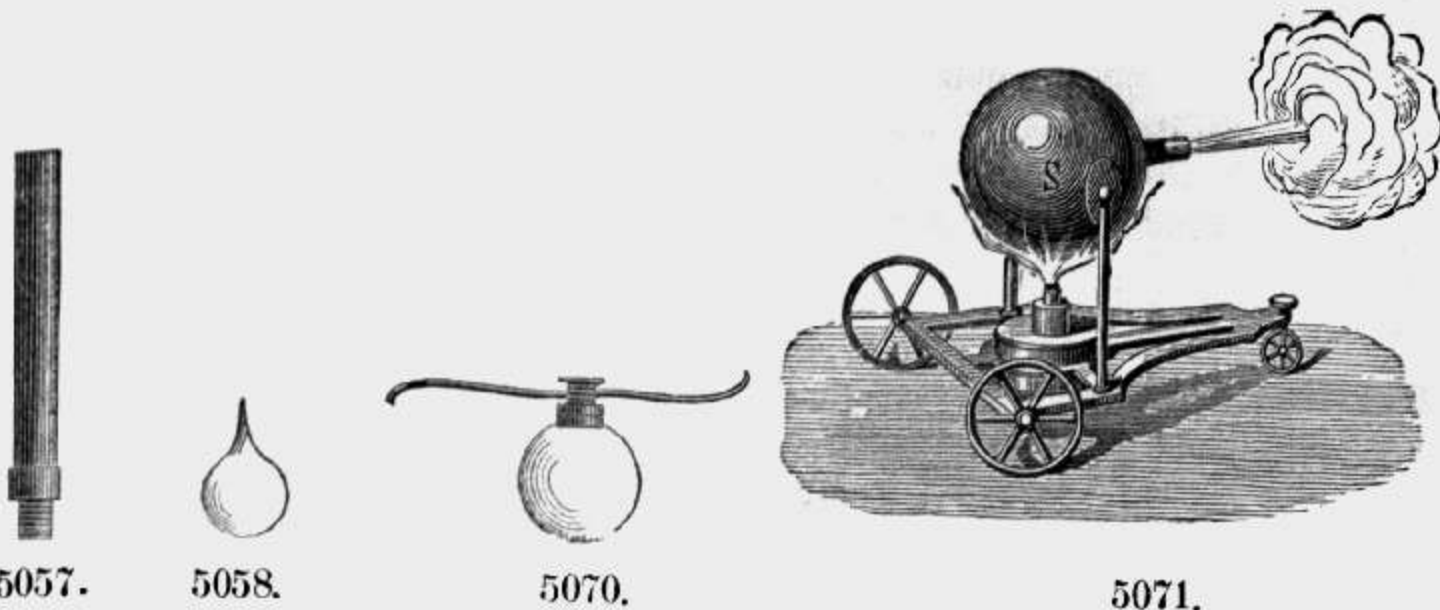

	PRICE
5057. <b>Tube of Brass.</b> Five inches long, to screw to the whirling table, No. 4078, and a pair of wooden jaws, to illustrate the boiling of water by friction.....	\$2 50
5058. <b>Candle Bombs.</b> Per dozen.....	60

SECTION VI.—THE STEAM ENGINE.

5070. <b>Hero's Engine.</b> Of brass, with curved arms on a swivel joint.....	6 00
5071. <b>Hero's Engine.</b> With straight jet, mounted, with lamp, on a neat car.	10 00

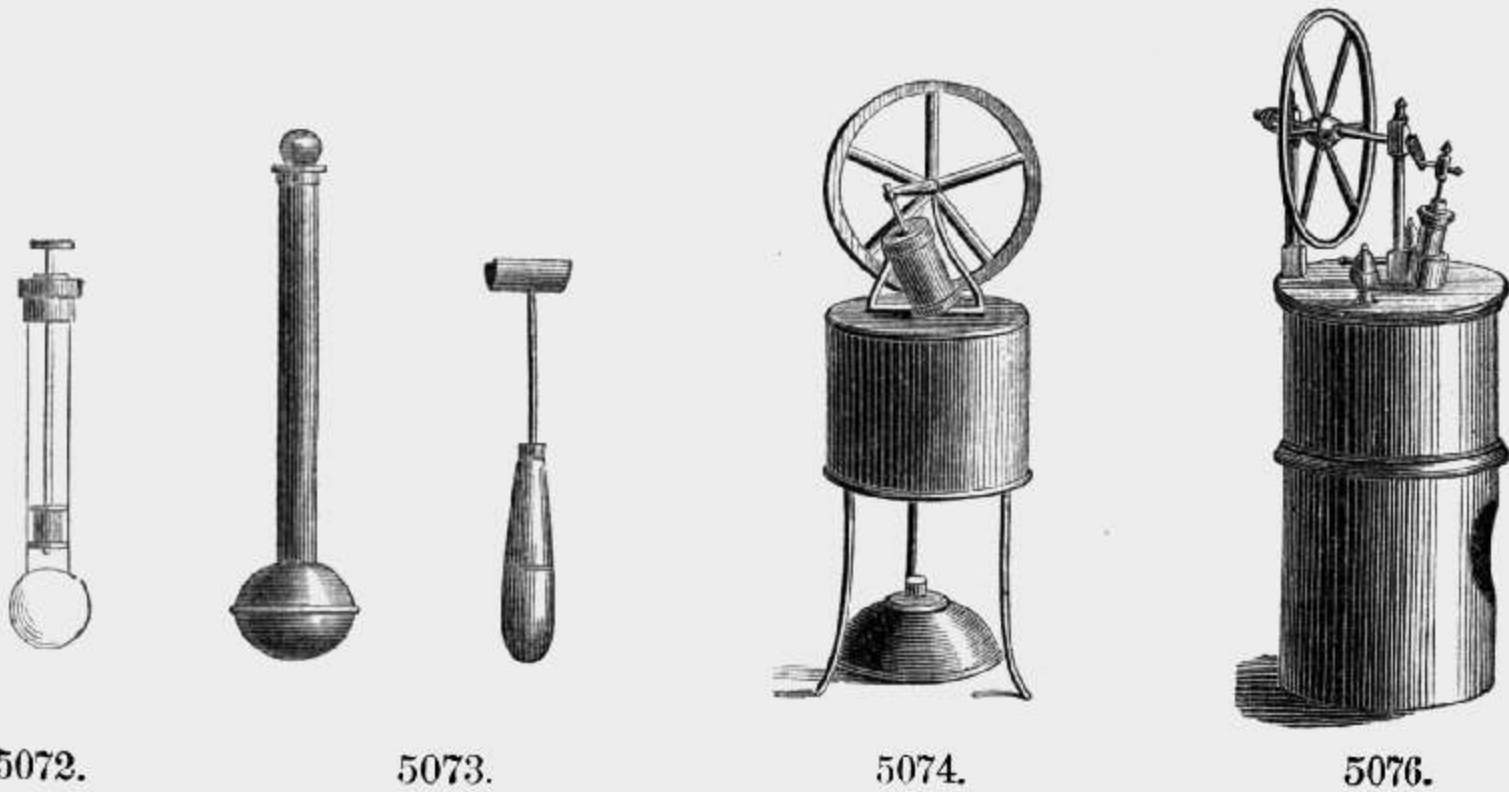

5072. <b>Wollaston's Illustration of a Low-pressure Engine.</b> Of strong glass.	1 50
5073. Same as No. 5072, but of brass, with safety valve, and handle with spring holder.....	5 50
5074. <b>Working Model of High-pressure Engine.</b> On tripod, with <i>tin</i> boiler, oscillating cylinder and lamp.....	3 00
5075. <b>Working Model of a High-pressure Engine.</b> On tripod, with <i>brass</i> boiler, oscillating cylinder, lamp, and low-water gauge.....	5 50
5076. <b>Working Model of a High-pressure Engine,</b> all of brass, on a neat brass stand, with oscillating cylinder, and lamp.....	10 00
5077. <b>Working Model,</b> same as No. 5076, but with low-water gauge.....	11 00

5078. **Working Model of High-pressure Engine.** Of brass, with detached boiler of copper, ten inches long and four inches in diameter, with safety-valve, high and low water gauges, connecting pipe, with stop-cock to shut off steam from the boiler, brass fly-wheel five inches in diameter, and driving-wheel on end of crank to permit the attachment of light articles for rotation. . . . . \$40 00

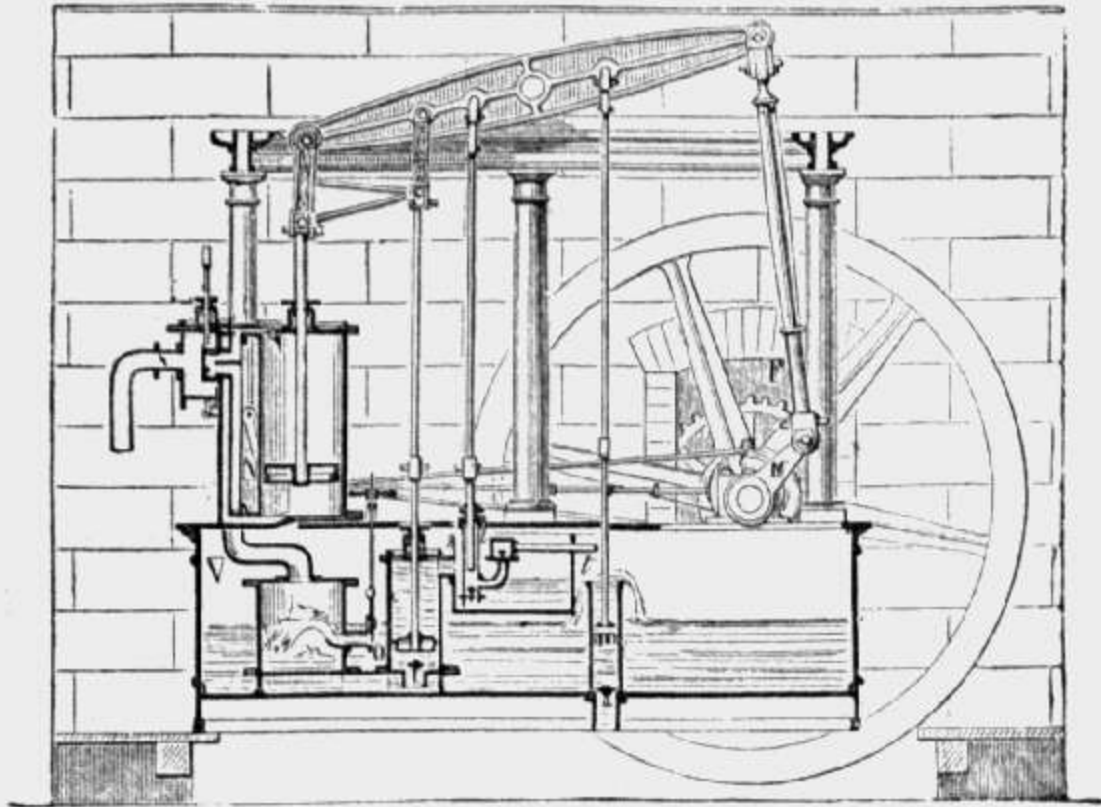

5095.

5095. **Sectional Model of Watts' Engine.** Of strong card-board. Showing all the interior valves and details of construction. Moved by a crank at the back. . . . . 10 00

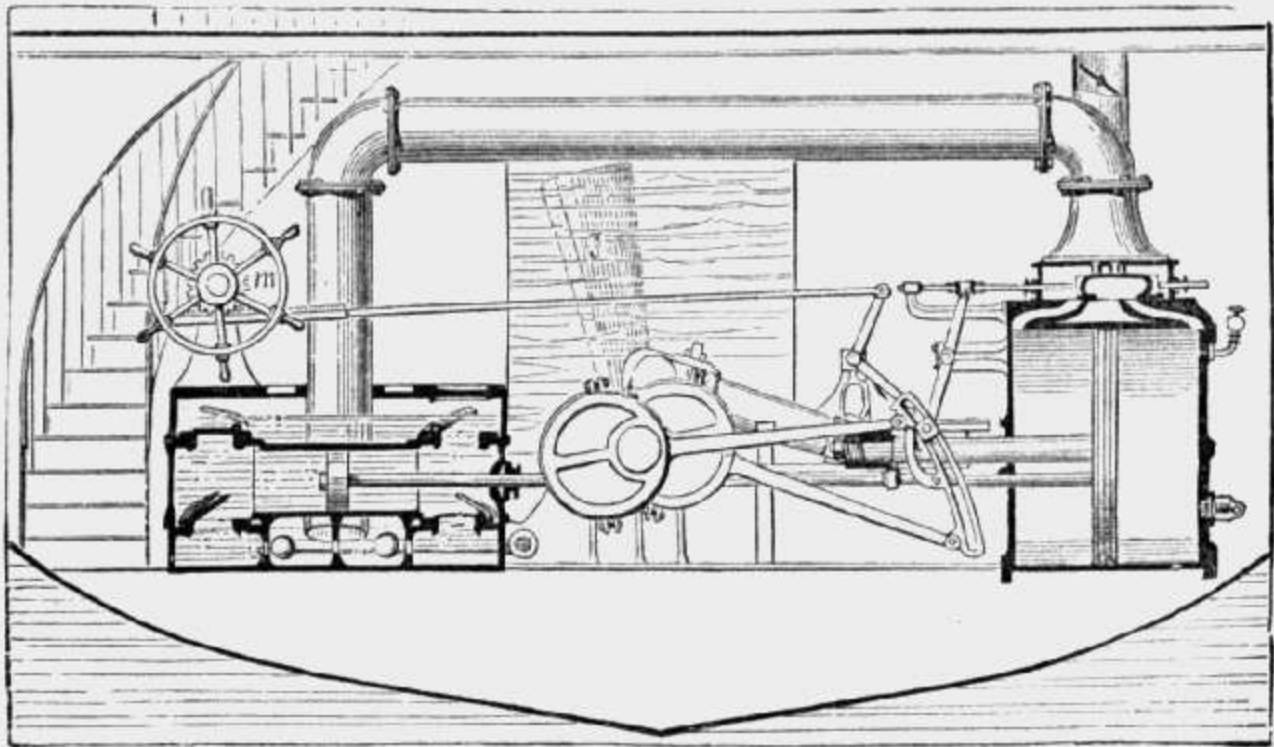

5096.

5096. **Sectional Model of a Marine, Side-wheel Engine.** Of strong card-board, showing all the interior valves and details of construction. Moved by a crank at the back. . . . . 12 00



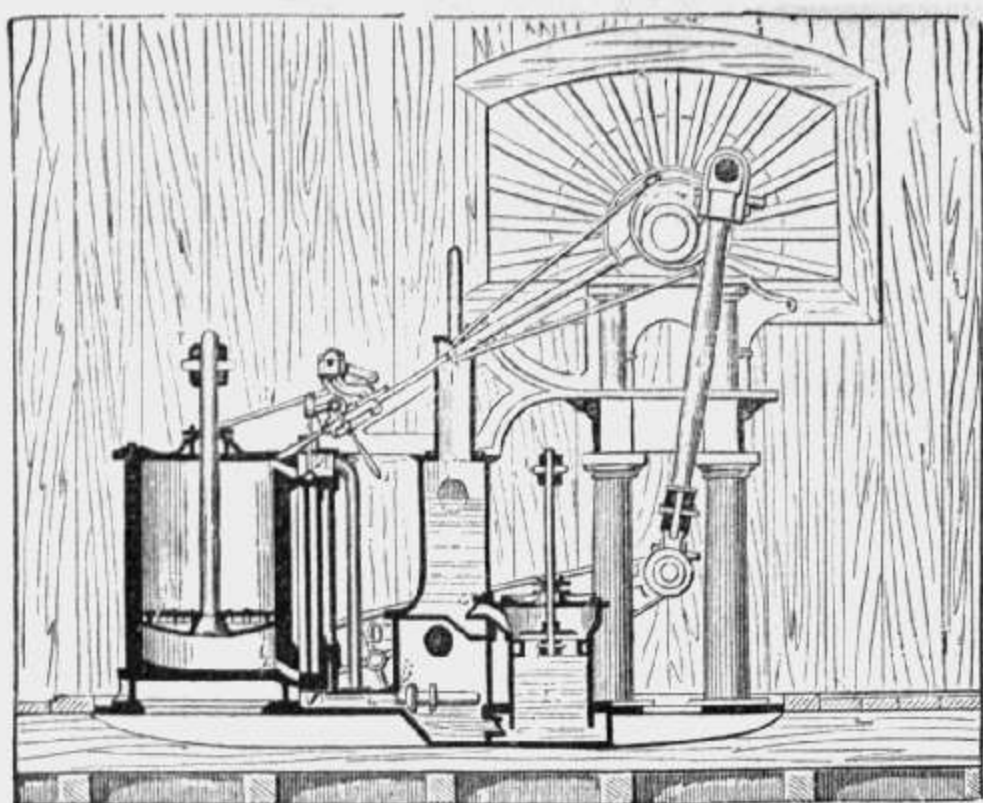

5097.

5097. Sectional Model of a Marine Engine, with Screw Propeller. Of strong card-board, showing all the interior valves and details of construction. Moved by a crank at the back . . . . . PRICE  
\$12 00

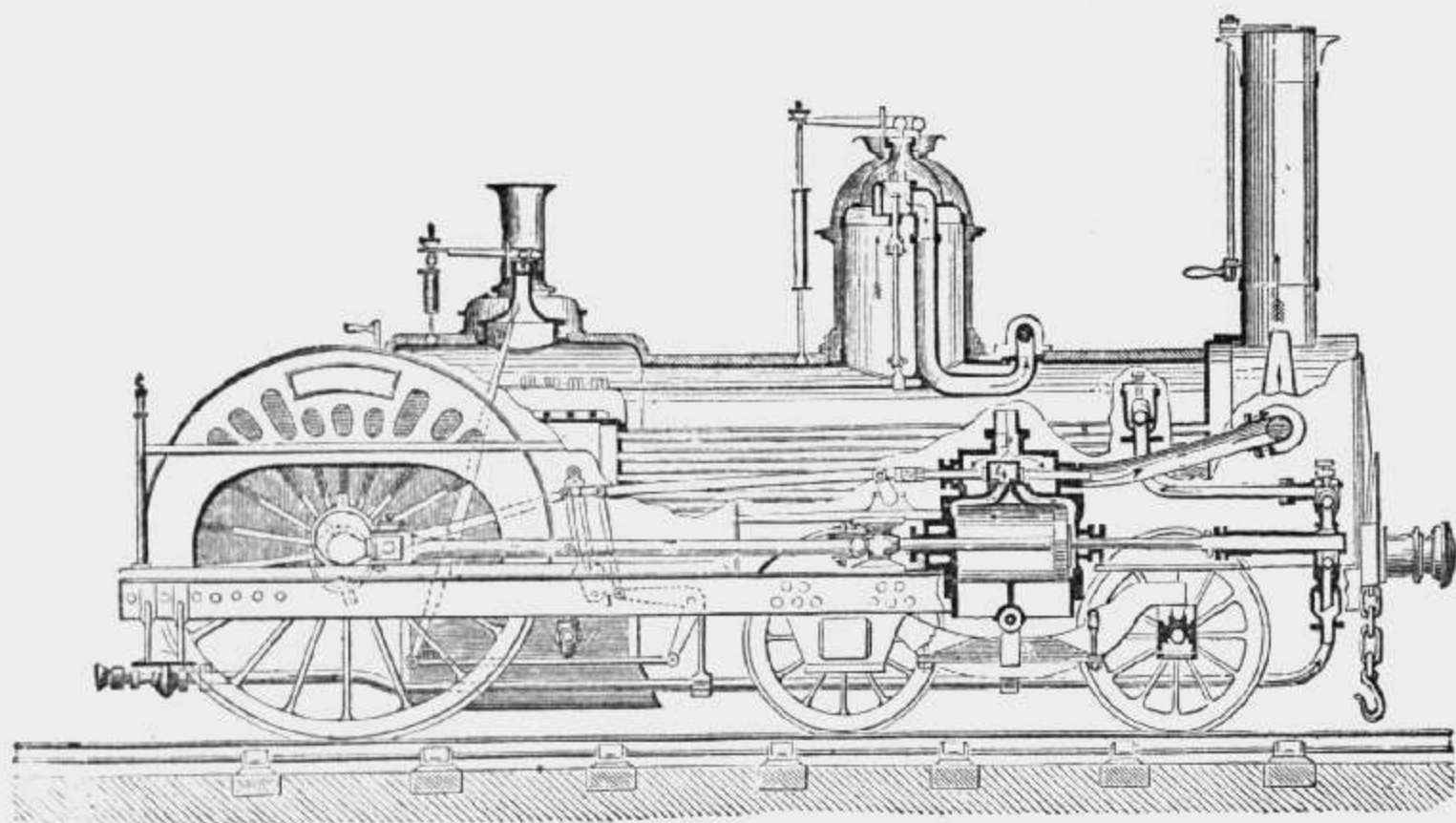

PEGARD

5098.

5098. Sectional Model of Locomotive Engine for high speed. Of strong card-board. Showing all the interior valves and details of construction. Moved by a crank at the back. . . . . 12 00

## SECTION VII.—HYGROMETERS.

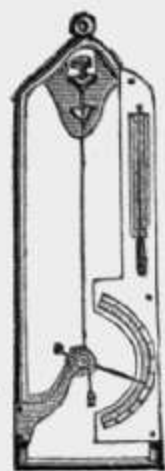

5110.

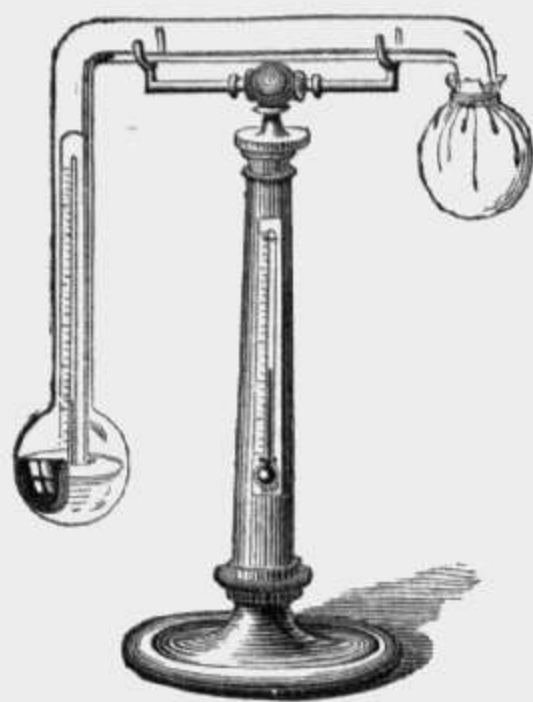

5111.

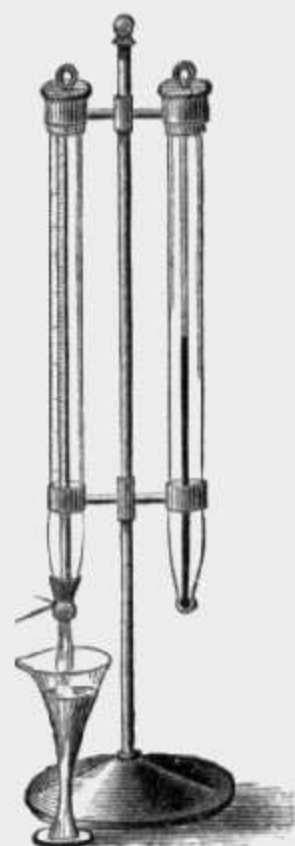

5112.

- |   | PRICE   |
|---|---------|
| 5110. <b>Saussure's, or Hair Hygrometer.</b> Nine and a half inches high, on brass frame, with thermometer. Very neatly finished and inclosed in a strong wood case.....  | \$15 00 |
| 5111. <b>Daniell's Hygrometer.</b> On brass base, with silvered metallic post. Whole instrument, eight inches high. In neat morocco case, lined with velvet.....  | 20 00   |
| 5112. <b>August's Psychrometer.</b> On neat brass stand, with brass arm for the thermometers, and holder for the water-cistern. Thermometers very delicate and accurate, graduated upon the tube to fifths of a degree Centigrade. The whole contained in a neat morocco case, lined with velvet..... | 30 00   |

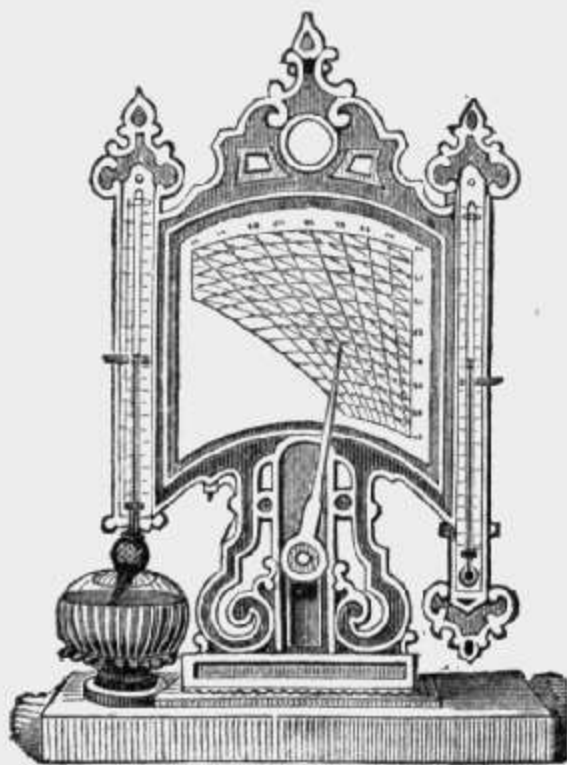

5117.

5117. **The Hygrodeik.** A very useful instrument for showing the actual temperature, the temperature due to evaporation, the relative amount of moisture, and the dew point, by adjusting the index on the dial. This instrument is especially suited for use in school-rooms and parlors. On a neat marble base.....

14 00

CHAPTER VII.

ELECTRICITY.

SECTION I.—INSTRUMENTS ILLUSTRATING THE FUNDAMENTAL PRINCIPLES OF ELECTRICITY.



5141.

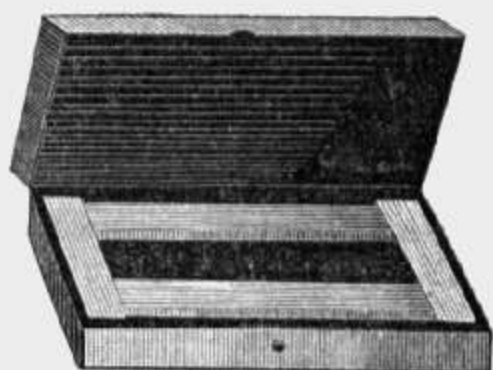

5143.



5146.



5148.

	PRICE
5138. <b>Lodestone, or Natural Magnet</b> .....	\$0 50
5139. <b>Lodestone.</b> Very strong, in brass frame, with rings.....	15 00
5141. <b>Bar Magnet.</b> Six inches long.....	1 25
5142. <b>Bar Magnets.</b> Pair, two inches long, to be used in projecting the "magnetic phantom"; in box, with armatures.....	2 50
51 Magnets. Pair, nine inches long, in neat wooden box, with armatures.....	3 50
5146. <b>Magnetic Needle.</b> Six inches long. On stand.....	2 50
5147. <b>Magnetic Needle.</b> Very superior, with agate centre.....	8 00
5148. <b>Magnetic Needle.</b> Fifteen inches long, suspended by a stirrup and cord from a brass stand.....	6 00



5149.

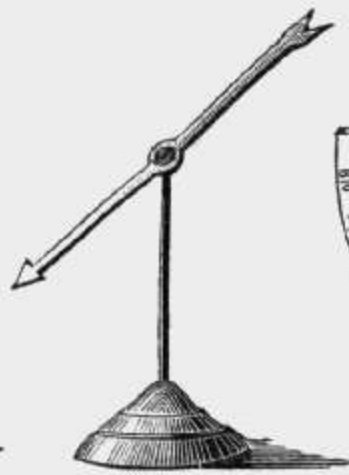

5150.

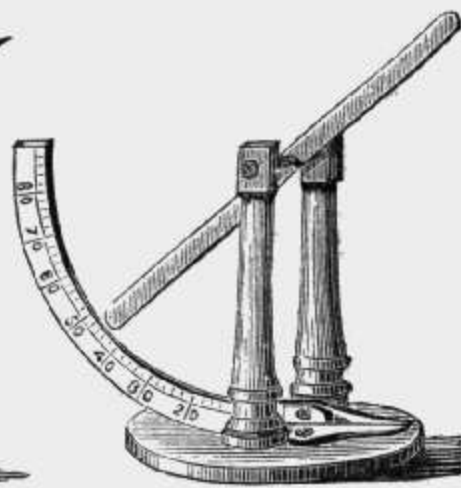

5151.

5149. <b>Dipping Needle.</b> Small Model. Needle, two inches long.....	2 00
5150. <b>Dipping Needle.</b> Large Model. Needle, twelve inches long, on universal joint, mounted on brass stand.....	8 00
5151. <b>Inclination Compass.</b> Graduated arc, needle three and a half inches long. Very delicate.....	10 00



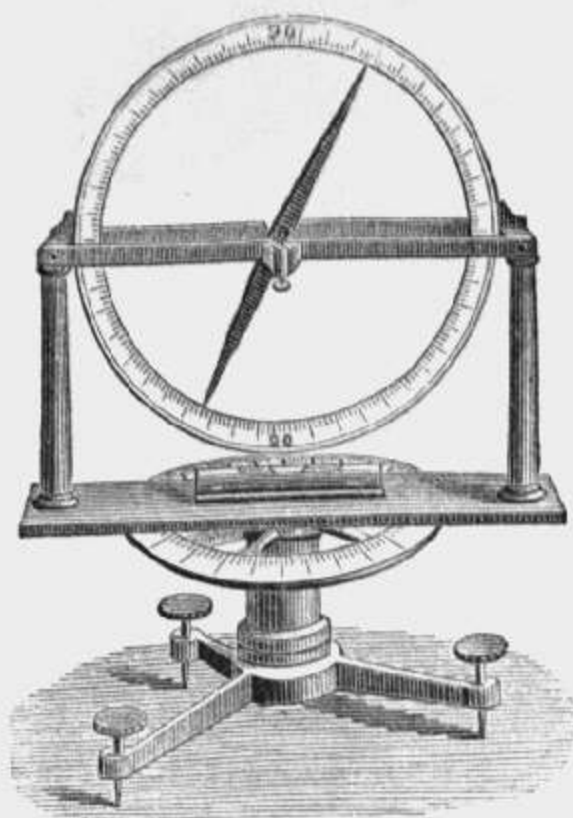

5152.

5152. **Inclination Compass.** Vertical circle, ten inches in diameter, horizontal circle, five inches; brass posts, base and leveling screws, all delicately finished ..... PRICE  
\$45 00



5155.

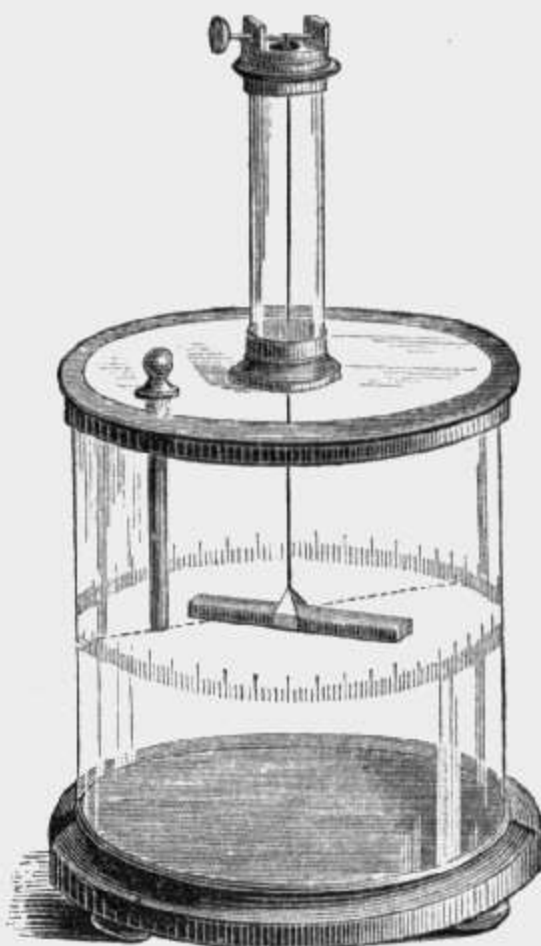

5158.

5155.	<b>Astatic Needle.</b>	Pair, six inches long, on a brass pivot and stand.	50
5156.	Astatic Needle.	Pair, twelve inches long, supported by an untwisted cord from a brass stand.....	6 00
5158.	<b>Torsion Balance.</b>	Glass case, eight inches in diameter and ten inches high.....	25 00
5170.	<b>Horseshoe Magnet,</b>	one inch long.....	15
5171.	“ “ “	two inches long.....	15
5172.	“ “ “	two and one-half inches long.....	20
5173.	“ “ “	three inches long.....	25
5174.	“ “ “	three and one-half inches long.....	30
5175.	“ “ “	four inches long.....	45
5176.	“ “ “	four and one-half inches long.....	60
5177.	“ “ “	five inches long.....	70
5178.	“ “ “	five and one-half inches long.....	85
5179.	“ “ “	six inches long.....	1 00

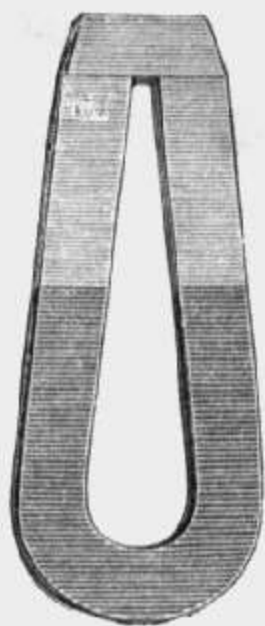

5170-81.

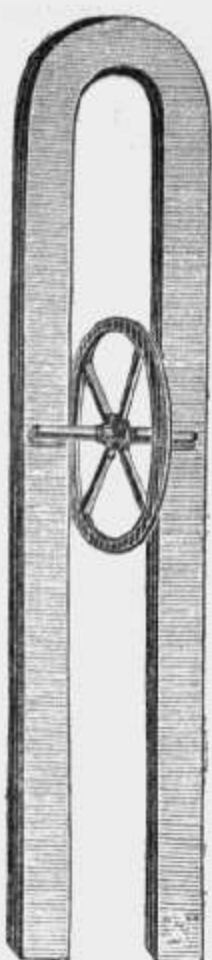

5186.

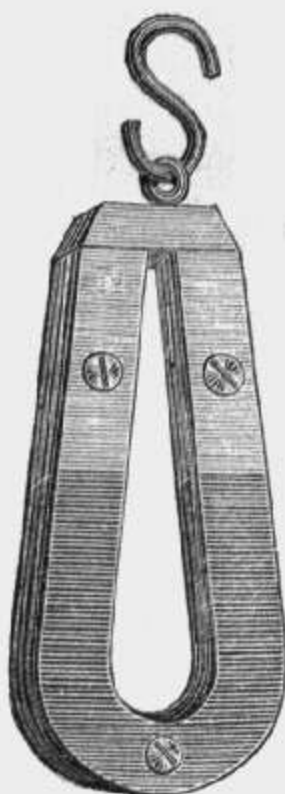

5187.

	PRICE
5180. <b>Horseshoe Magnet</b> , seven inches long.....	\$1 25
5181. " " " eight inches long.....	1 50
5185. " " " ten inches long, very superior quality.....	4 00
5186. " " " ten inches long, with rolling armature.....	3 25
5187. <b>Compound Horseshoe Magnet</b> , four bars, four inches long.....	5 00
5188. <b>Compound Horseshoe Magnet</b> , four bars, five inches long.....	6 00
5189. <b>Compound Horseshoe Magnet</b> , four bars, six inches long.....	7 50



5216.



5217.

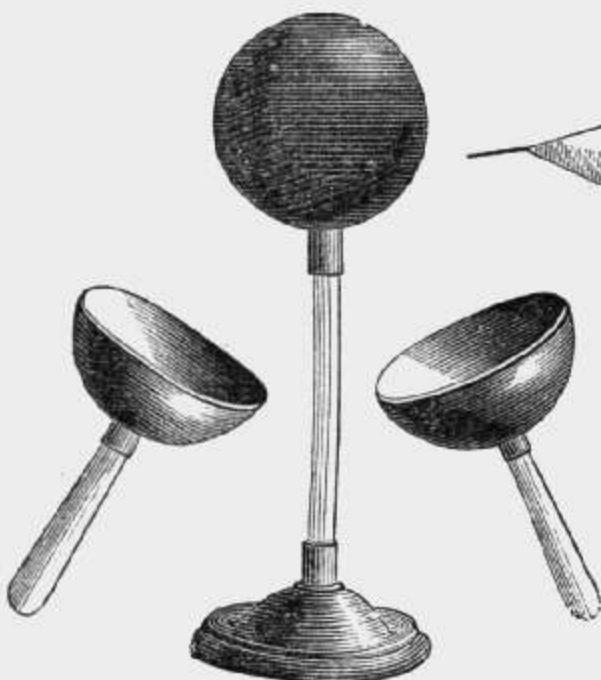

5218.



5219.

5210. <b>Pith Balls</b> , per dozen.....	25
5211. <b>Pith Balls</b> , suspended by cords, each.....	10
5212. <b>Glass Rod</b> , for excitation.....	1 00
5213. <b>Rod of Shellac</b> , for excitation.....	2 00
5214. <b>Plate of Vulcanite</b> , for excitation.....	2 00
4215. <b>Cat's Skin</b> , for exciter.....	1 00
5216. <b>Hollow Sphere</b> , five inches in diameter. To show that electricity resides only on the surface of bodies. On neat insulating stand, with proof plane.....	11 00
5217. <b>Faraday's Wire Cylinder</b> , on a polished, insulated brass plate.....	5 00
5218. <b>Biot's Hemispheres</b> . Pair of hollow brass hemispheres, on insulating stand, inclosing a silvered insulated sphere, four inches in diameter.	14 00
5219. <b>Faraday's Bag</b> , on insulated ring, six inches in diameter.....	5 00



5221.



5222.

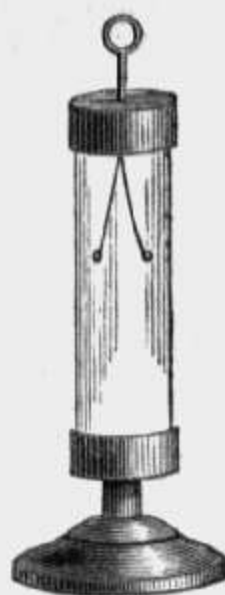

5224.

	PRICE
5221. <b>Induction Cylinders</b> , of brass, finely finished, seven inches long, on neat insulating stand. . . . .	\$5 00
5222. <b>Induction Globe</b> , of silvered brass, four inches in diameter, on strong insulating stand. . . . .	9 00
5223. <b>Pith Ball Electroscope</b> , plain . . . . .	1 00
5224. <b>Plain gold Leaf Electrometer</b> . . . . .	5 00

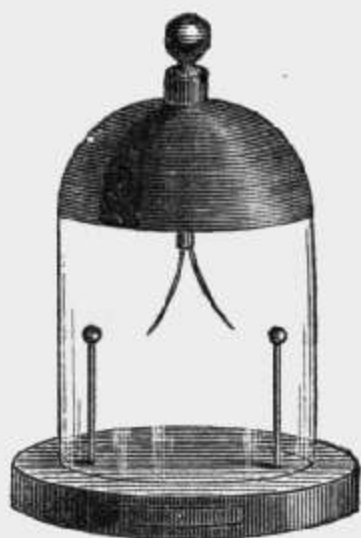

5225.

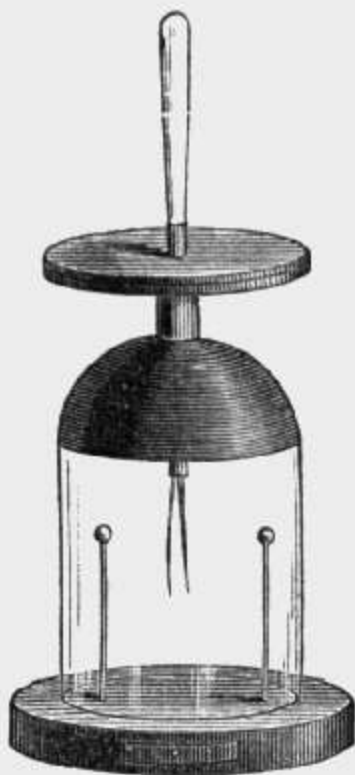

5226.



5227.

5225. <b>Bennett's Electroscope</b> , or Gold Leaf Electrometer, with ball. Glass bell, nine inches high by seven and a half inches in diameter, mounted on wooden base, with drawer for drying material. This and the following electroscopes are finely finished in every part, and are of exceeding delicacy . . . . .	20 00
5226. <b>Bennett's Electroscope</b> , same as No. 5225, but with Volta's condenser instead of ball. . . . .	25 00
5227. <b>Saussure's Electroscope</b> . . . . .	25 00



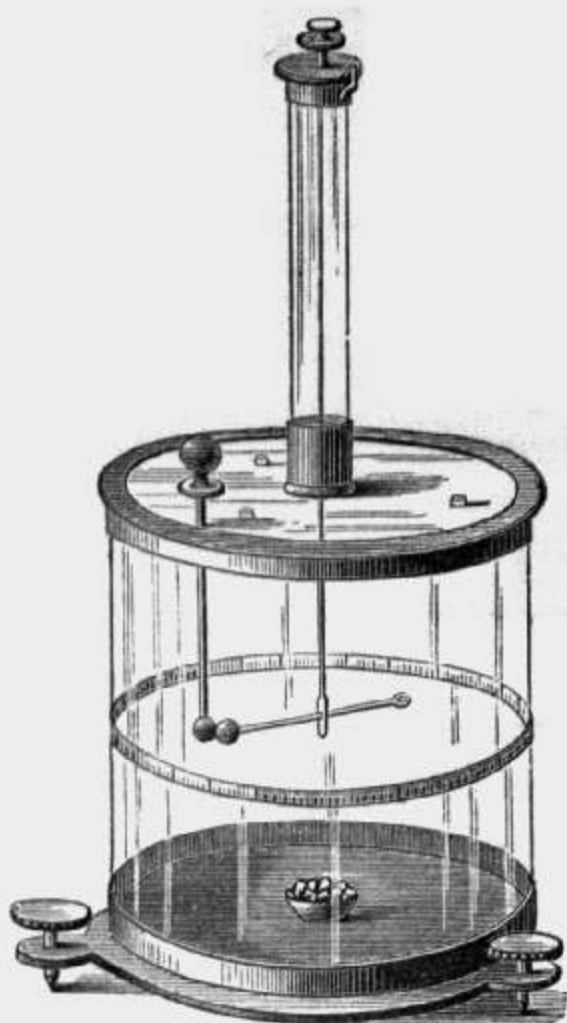

5228.

	PRICE
5228. <b>Coulomb's Electrometer.</b> Glass case, eight inches in diameter, and ten inches high, on neat stand of mahogany.....	\$25 00
5229. <b>Thomson's Electrometer</b> , as improved by Bunsen. This is, perhaps, the most perfect instrument for the detection and measurement of small quantities of electricity, yet devised. Furnished with lamp and transparent scale for receiving the indications; complete.....	100 00

## SECTION II.

## INSTRUMENTS FOR OBTAINING ELECTRICITY OF TENSION BY FRICTION.

5240. <b>Electrophorus</b> , of sealing wax, with brass base and plate, ten inches in diameter.....	8 00
5241. <b>Electrophorus</b> , of sealing wax, with brass base and plate, fifteen inches in diameter.....	10 00
5242. <b>Electrophorus</b> , of vulcanite, ten inches in diameter, with brass base and plate.....	10 00
5243. <b>Electrophorus</b> , of vulcanite, fifteen inches in diameter, with brass base and plate.....	15 00
5244. <b>Friction Machine.</b> Plate, of <i>glass</i> , twelve inches in diameter, with solid walnut base. Prime Conductor of tin, neatly japanned, silk apron, box of amalgam, and three feet of brass chain.....	25 00

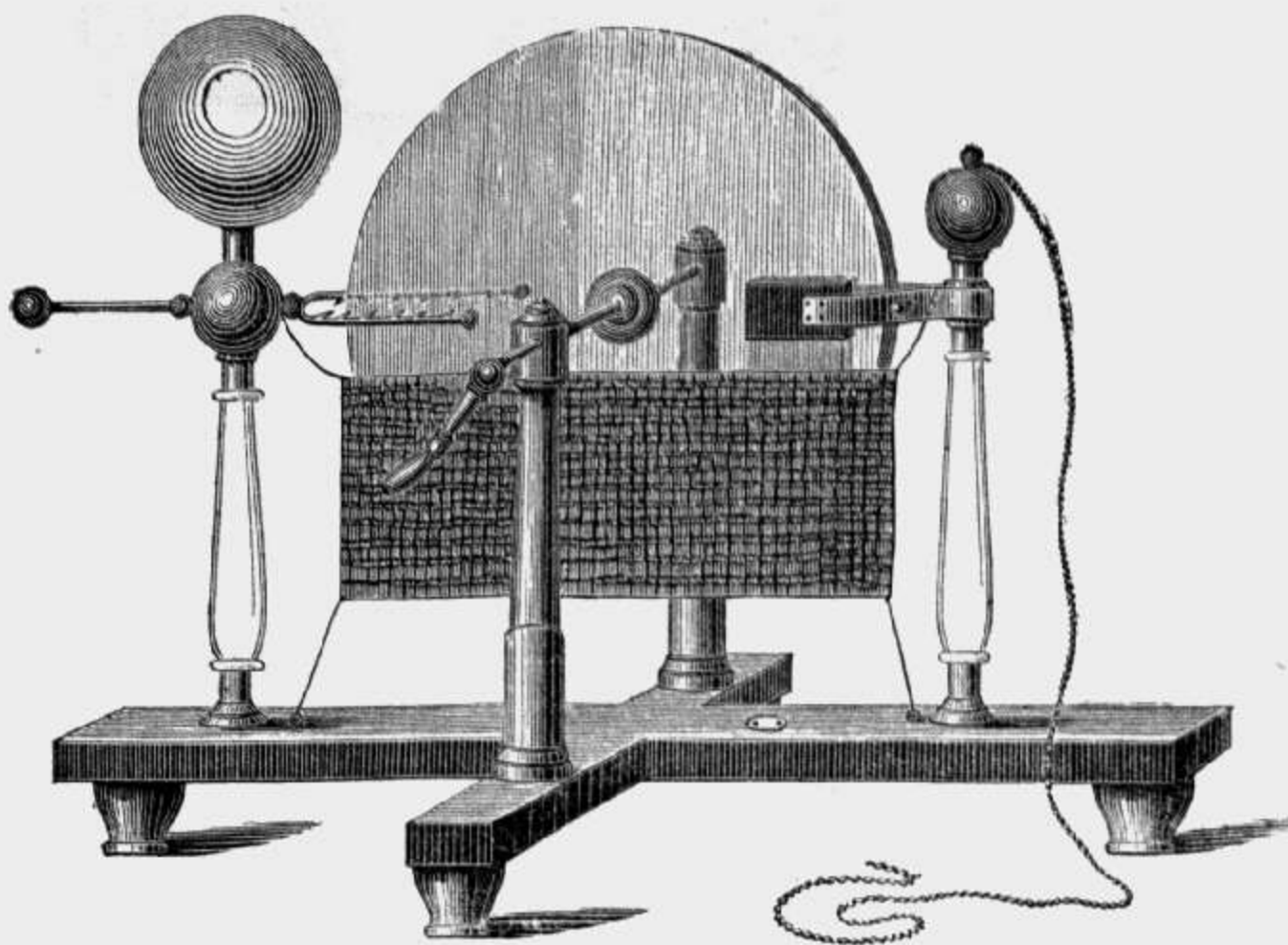

5245-48.

- |  | PRICE   |
|--|---------|
| 5245. <b>Friction Machine.</b> Glass plate, sixteen inches in diameter, solid walnut base, finely polished, felt rubbers of best quality, insulated positive and negative conductors, of brass; Rogers' condenser, silk apron, box of amalgam, and four feet of brass chain..... | \$30 00 |
| 5246. <b>Friction Machine.</b> Glass plate, twenty inches in diameter, with solid polished walnut base, felt rubbers of best quality, insulated positive and negative conductors, of brass; Rogers' condenser, silk apron, box of amalgam, and five feet of brass chain.....     | 40 00   |
| 5247. <b>Friction Machine.</b> Glass plate, twenty-four inches in diameter, with solid polished walnut base, felt rubbers of best quality, insulated positive and negative conductors, of brass; Rogers' condenser, silk apron, box of amalgam, and six feet of brass chain..... | 65 00   |
| 5248. <b>Friction Machine.</b> Glass plate, thirty inches in diameter, with solid polished walnut base, felt rubbers of best quality, insulated positive and negative conductors, of brass; Rogers' condenser, silk apron, box of amalgam, and eight feet of brass chain.....    | 100 00  |

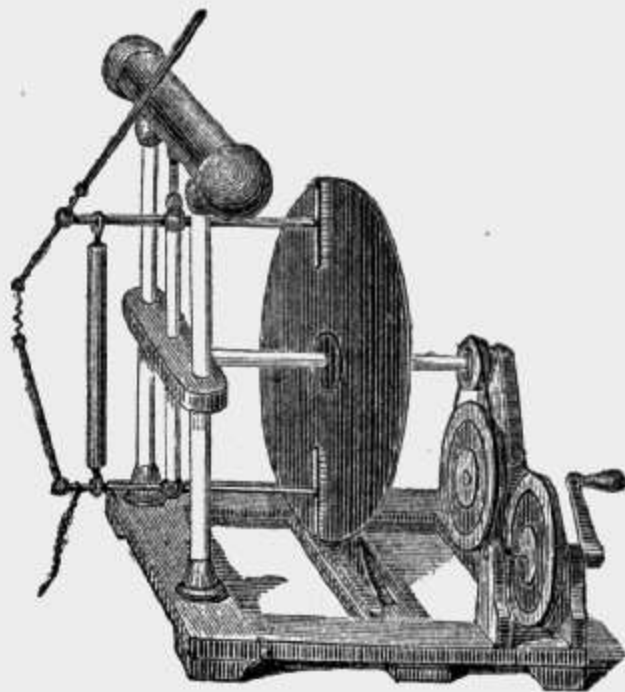

5249.

- |  |        |
|--|--------|
| 5249. <b>Bertsch Machine.</b> Inducing plate of rubber, twenty-one inches in diameter..... | 100 00 |
|--|--------|

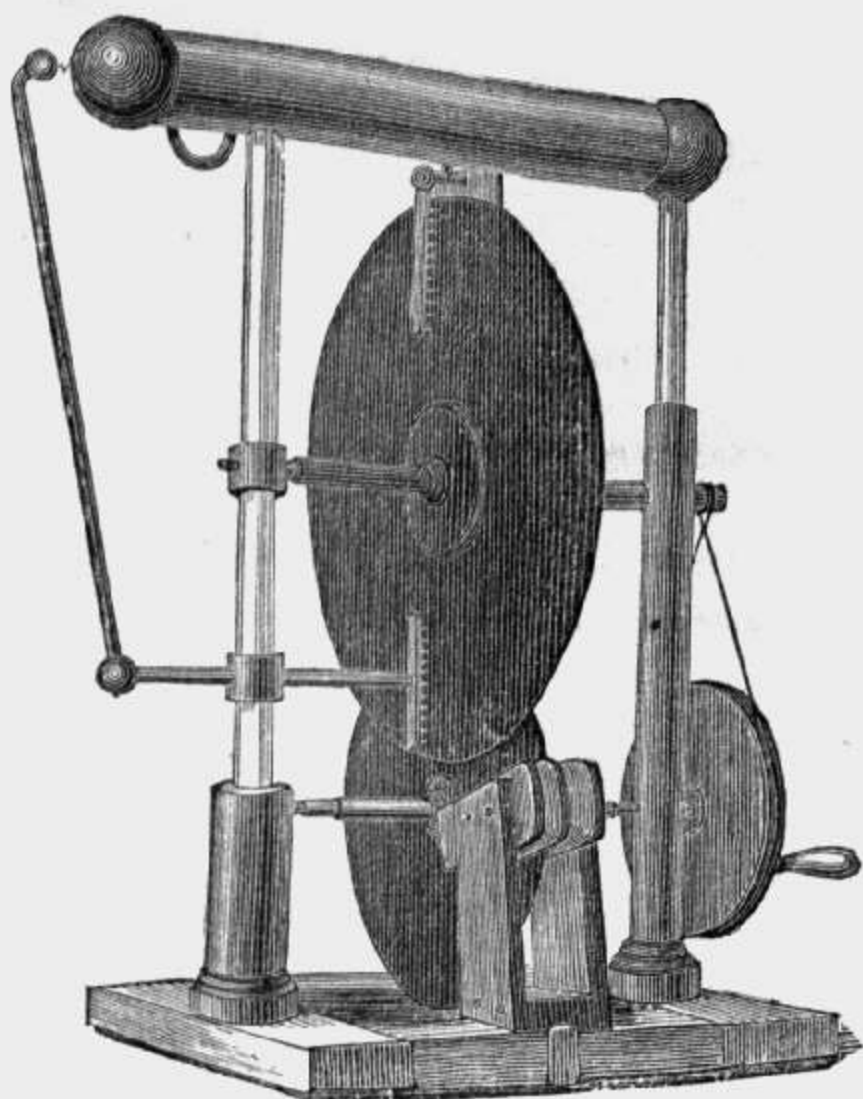

5250-53.

	PRICE
5250. <b>Dielectric Machine.</b> Both plates of hard rubber. Friction plate eight inches in diameter. Main plate, thirteen inches in diameter. With condenser. Gives torrent of sparks five inches long.....	\$80 00
A paper of amalgam and a brass chain accompanies each size of "The Dielectric."	
5251. Dielectric Machine. Similar to No. 5250, but with plates thirteen and eighteen inches in diameter, and giving sparks of seven inches	110 00
5252. Dielectric Machine. Similar to No. 5250, but with plates fifteen and nineteen inches in diameter, and giving sparks of nine inches.....	150 00
5253. Dielectric Machine. Similar to No. 5250, but with plates seventeen and twenty-four inches in diameter, and giving sparks of twelve inches.....	215 00
5260. <b>Holtz Machine.</b> Plate of hard rubber, seventeen inches in diameter. Inducing plates also of hard rubber. With cat's skin and brass chain.....	100 00

SECTION III.—ON THE ATTRACTION AND REPULSION OF TENSIONAL ELECTRICITY.



5270 and 5271.



5272.

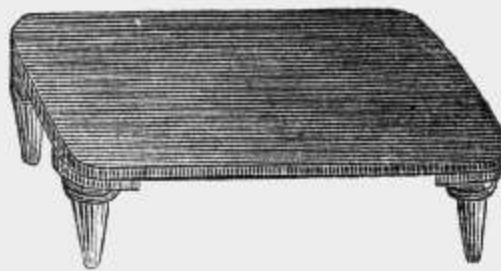

5273 and 5274.

5270. <b>Directing Rod.</b> Of brass, with balls and adjusting slide. Three feet in length.....	3 50
5271. Directing Rod. Same as No. 5270, but four feet in length.....	4 00
5272. <b>Quadrant Electrometer,</b> and stand.....	2 50



	PRICE
5273. <b>Insulating Stool.</b> Of cherry, with feet of glass.....	\$5 50
5274. <b>Insulating Stool.</b> Of mahogany, finely finished, with feet of glass, fitted into screw sockets of brass.....	10 00



5275.



5276.

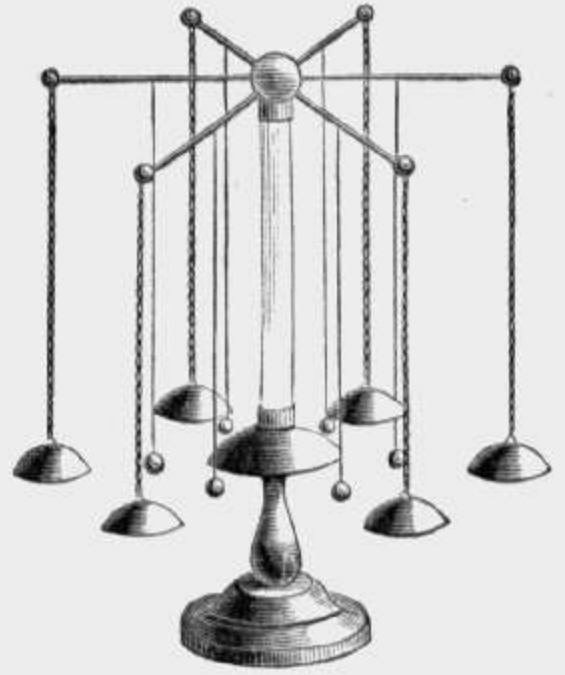

5277.

5275. <b>Electrical Chime.</b> Two bells.....	2 25
5276. <b>Electrical Chime.</b> Three bells .....	3 50
5277. <b>Electrical Chime.</b> Five bells, centre one four inches in diameter. ....	11 00
5278. <b>Electrical Vane</b> .....	1 25
5279. <b>Head of Hair</b> .....	2 00
5280. <b>Tissue Figure</b> .....	1 75



5281.

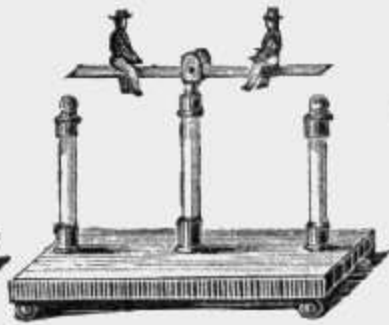

5282.



5283.

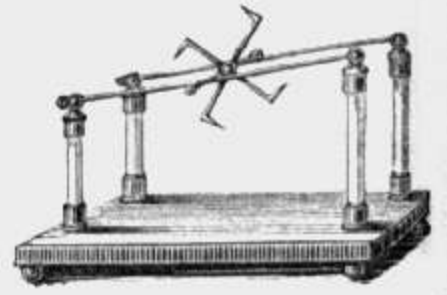

5284.

5281. <b>Electrical Swing</b> .....	5 00
5282. <b>Electrical See-Saw</b> .....	4 50
5283. <b>Electrical Orrery.</b> To place in prime conductor.....	2 50
5284. <b>Electrical Inclined Plane</b> .....	5 00



5285.



5286.



5288.

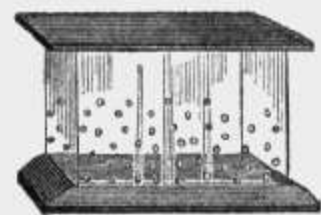

5289.

5285. <b>Electrical Bucket</b> .....	1 50
5286. <b>Revolving Globe</b> .....	4 00

5288. Volta's Hail Storm .....	PRICE
5289. Volta's Hail Storm. Arranged for projection.....	\$5 00
	5 00

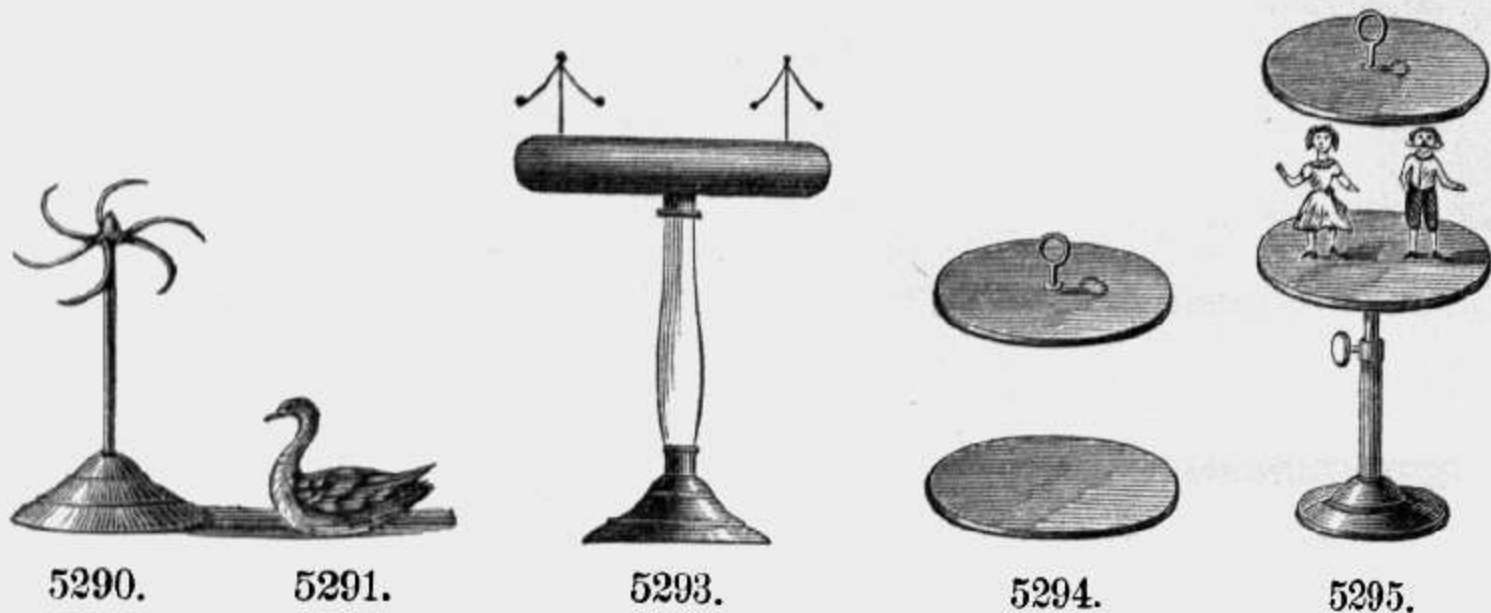

5290. Electrical Flier and Stand .....	1 75
5291. Electrical Swan.....	1 50
5292. Electrical Spider.....	40
5293. Insulated Conductor. Of brass, 5 inches in diameter and 24 inches long.....	18 00
5294. Metallic Plates. For dancing images, for suspension. Of tin, neatly japanned, ten inches in diameter. Not adjustable.....	2 50
5295. Metallic Plates. For dancing images. Similar to No. 5294, but lower one on an adjusting stand.....	4 50
5297. Dancing Images. Of pith, per pair.....	1 00

SECTION IV.—CONDENSERS AND THE LEYDEN JAR.

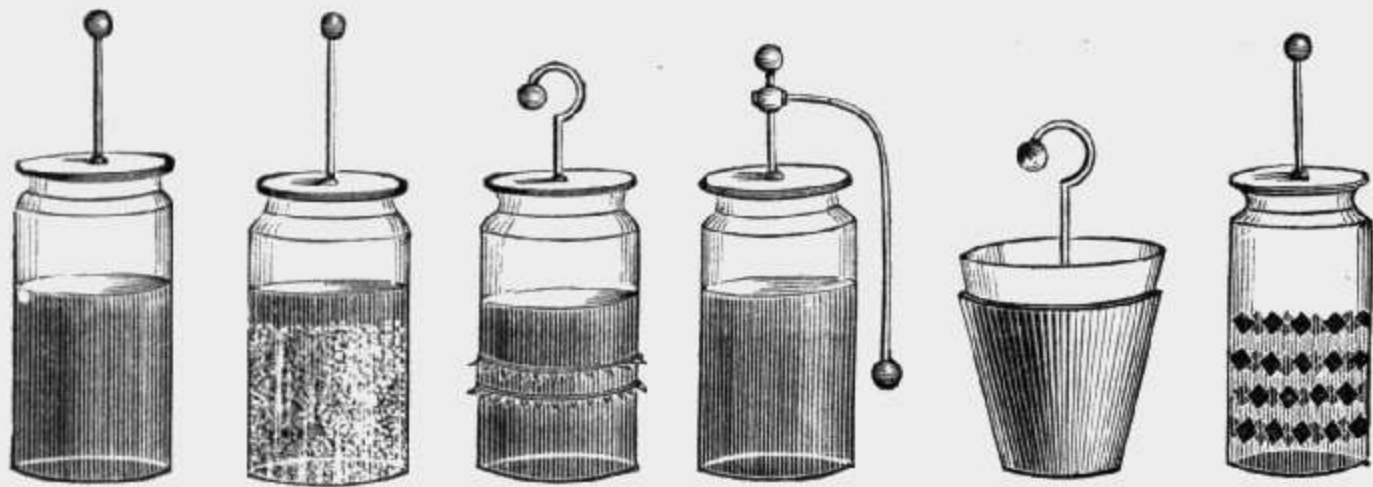

5310-13.      5314.      5315.      5316.      5317.      5318 and 5319.

5310. Leyden Jar. One pint.....	1 50
5311. Leyden Jar. One quart.....	2 00
5312. Leyden Jar. One half gallon.....	2 75
5313. Leyden Jar. One gallon.....	3 25
5314. Lightning Jar. Half gallon.....	2 50
5315. Atmospheric Leyden Jar. Half gallon.....	3 75
5316. Electrometer Jar. Half gallon.....	3 25
5317. Leyden Jar. With movable coatings.....	3 50
5318. Diamond Jar. Half gallon.....	4 00
5319. Diamond Jar. Gallon.....	5 00

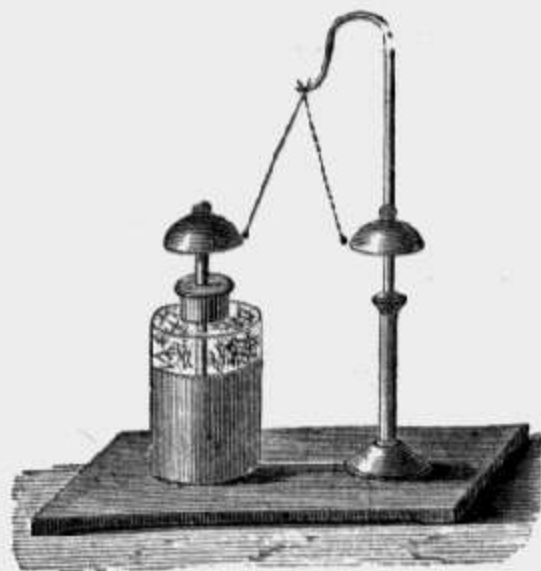

5320.

5320. **Leyden Jar.** With bell and ball for slow discharge.....

PRICE  
\$6 50



5321 and 22.



5324.



5325.

- 5321. **Double Jar.** Pint and quart..... 5 00
- 5322. **Double Jar.** Quart and half gallon..... 6 25
- 5324. **Electrical Sportsman.** On stand, with Leyden jar, and birds ..... 7 50
- 5325. **Electrical Sportsman and electrometer jar with birds.**..... 4 00
- 5326. **Electrical Sportsman, and birds, without jar.**..... 1 25
- 5327. **Miser's Plate.** Ten inches by twelve, unmounted..... 1 25
- 5328. **Miser's Plate.** Same as No. 5327, but in a neat walnut frame..... 2 50

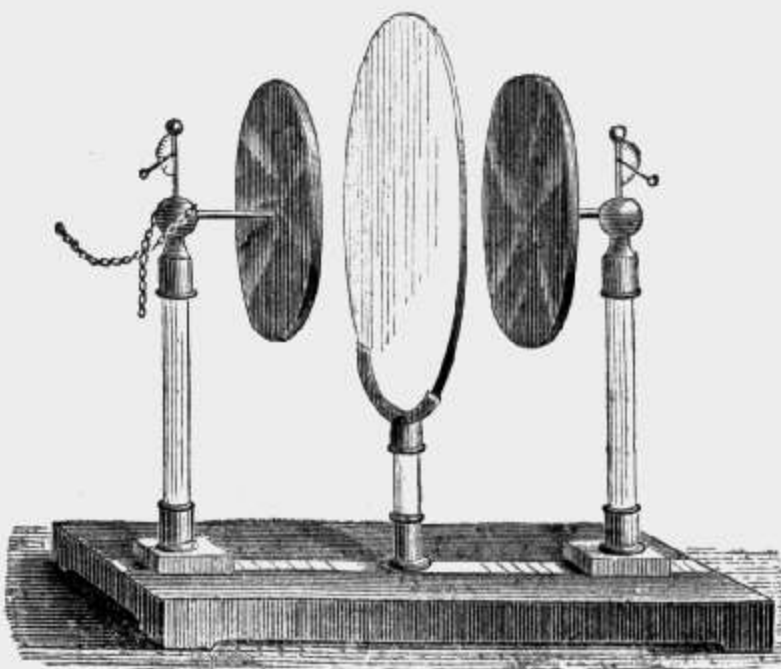

5335.

5335. **Condenser of Epinus.** Outer plates each six and a half inches in diameter, on neat mahogany stand.....

25 00



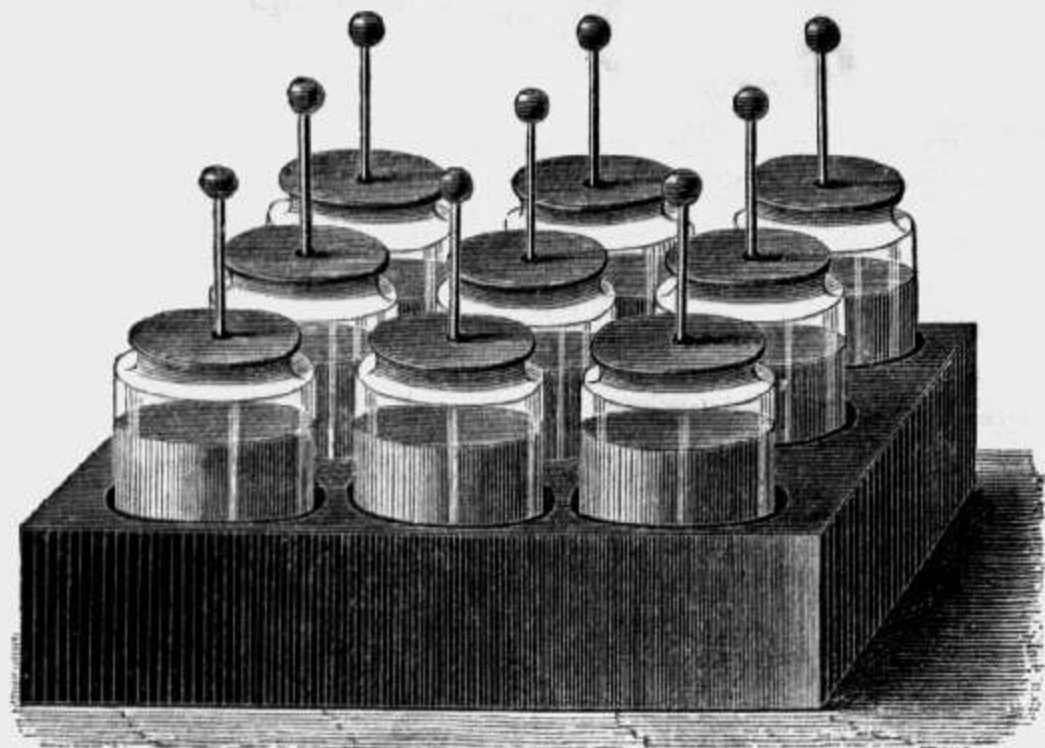

5340.

	PRICE
5336. <b>Electrical Battery.</b> In neat walnut tray, containing four quart jars..	\$10 00
5337. <b>Electrical Battery.</b> Similar to No. 5336, but with six quart jars....	15 00
5338. <b>Electrical Battery.</b> In neat walnut tray, containing four half-gallon jars.....	14 00
5339. <b>Electrical Battery.</b> Similar to No. 5338, but with six half-gallon jars.	18 00
5340. <b>Electrical Battery.</b> Same as above, but with nine half-gallon jars...	27 00
5341. <b>Electrical Battery.</b> In neat walnut tray, with handles, containing four one-gallon jars.....	16 00
5342. <b>Electrical Battery.</b> Similar to No. 5341, but with six one-gallon jars.	24 00



5345.

5346.

5347.

5345. <b>Glass or Rubber Handle Discharger.</b> Not jointed.....	3 00
5346. <b>Glass or Rubber Handle Discharger.</b> Jointed.....	5 00
5347. <b>Discharger.</b> With two handles of glass or rubber.....	5 50

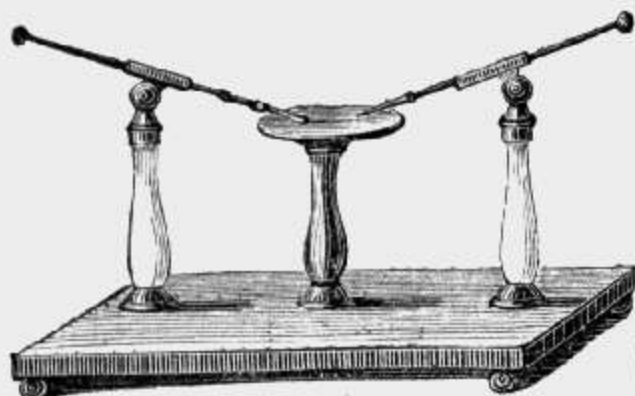

5349.

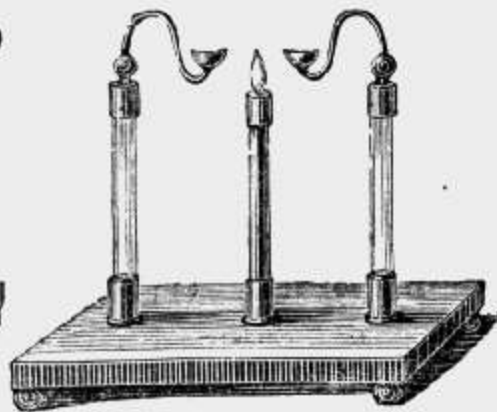

5350.

5349. <b>Universal Discharger.</b> Insulated arms and adjusting table.....	15 00
5350. <b>Phosphorus Apparatus.</b> .....	5 00

SECTION V.—ON THE ELECTRICAL DISCHARGE.

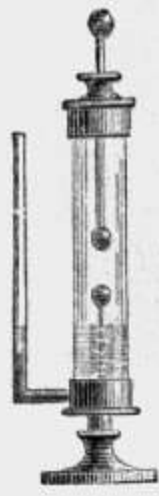

5359.

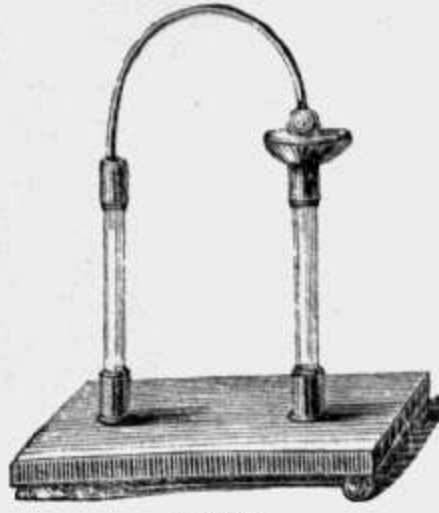

5360.

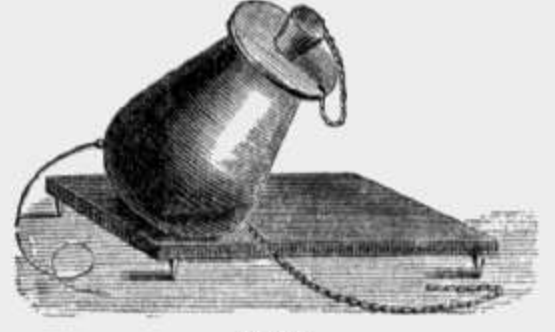

5361.

	PRICE
5359. <b>Kinnersley's Thermometer</b> .....	\$7 50
5360. <b>Powder Apparatus</b> .....	4 50
5361. <b>Powder Bomb.</b> Of wood, on mahogany base.....	2 00

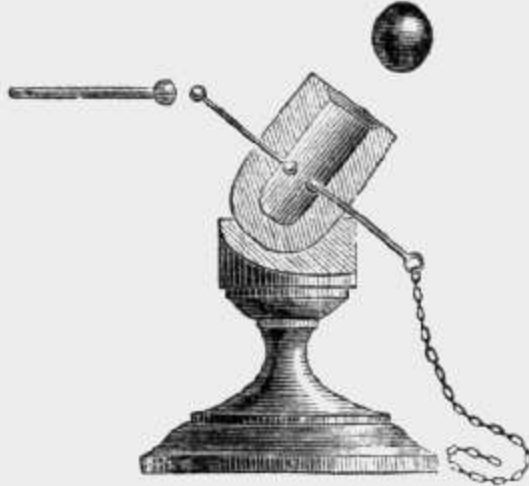

5364.



5366.



5367.



5368.

5363. <b>Electrical Pistol.</b> Of brass, with wooden handle.....	8 00
5364. <b>Electrical Bomb.</b> Of ivory, on mahogany base.....	5 00
5365. <b>Electrical Pyramid</b> .....	4 50
5366. <b>Fire House of Japanned Tin</b> .....	6 50
5367. <b>Ether Cup,</b> with ball at centre and with handle of wood.....	1 50
5368. <b>Brass Ball.</b> On handle, to be used in igniting cotton.....	1 75
5370. <b>Fulminating Pane.</b> Plate of Glass, twelve inches square, with the middle coated with filings, to show the zigzag course of the electric spark. Not framed.....	1 75
5371. <b>Fulminating Pane.</b> In neat frame, on stand.....	5 00
5372. <b>Luminous Pane.</b> With various devices, such as a star, arch, motto, flowers, etc., etc., in neat frame on stand.....	7 00
5373. <b>Luminous Globe.</b> On polished walnut base.....	9 00
5374. <b>Luminous or Diamond Tube.</b> Straight. One foot long.....	3 00
5375. <b>Luminous Tube.</b> Straight. Two feet long.....	4 00
5376. <b>Luminous Tube.</b> Straight. Three feet long.....	5 00
5377. <b>Luminous Tube.</b> With hook for suspension. Three feet long.....	5 50



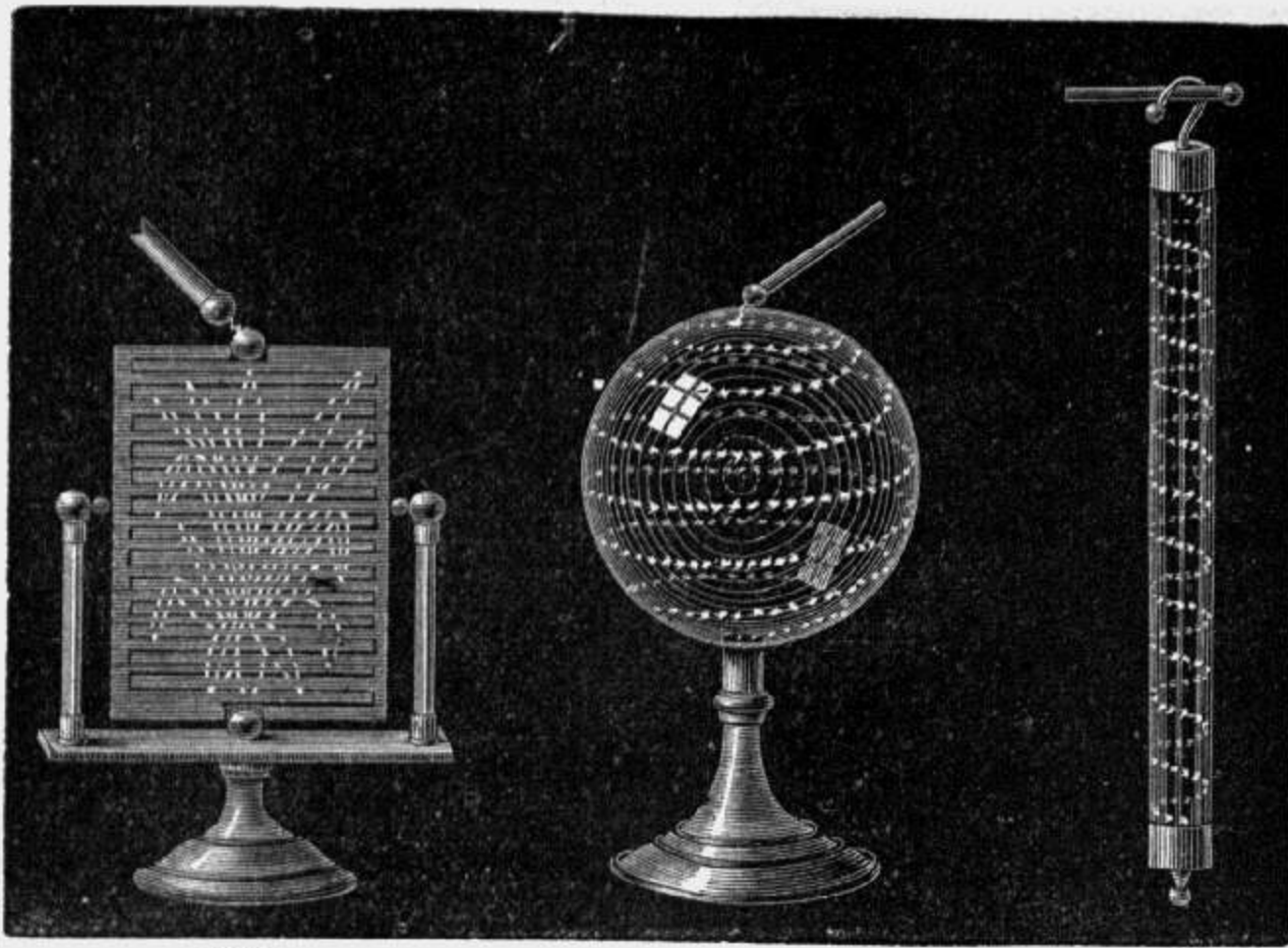

5372.

5373.

5377.

	PRICE
5380. <b>Aurora Tube.</b> Plain glass, three feet long.....	\$8 00
5381. <b>Aurora Tube.</b> Plain glass, four feet long.....	9 00
5382. <b>Aurora Tube.</b> Plain glass, extra size, four feet long.....	12 00
5384. <b>Aurora Tube.</b> Of uranium glass, three feet long.....	12 00



5380-84.



5388.

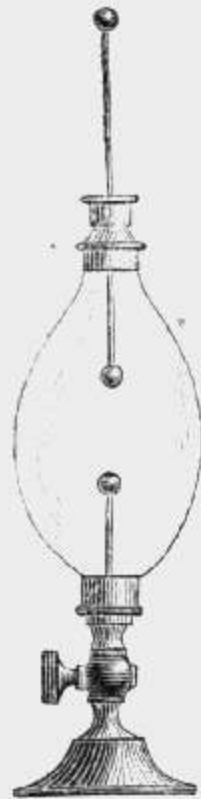

5389-92.

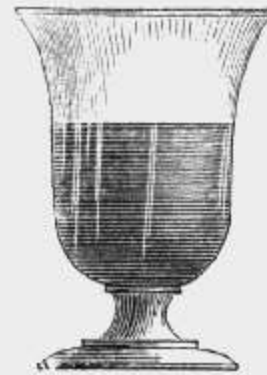

5395-98.

5388. <b>Abbe Nollett's Globe,</b> with receiver.....	8 00
5389. <b>Electrical Egg.</b> Twelve inches high, of plain glass.....	9 00
5390. <b>Electrical Egg.</b> Sixteen inches high, plain glass.....	12 00
5391. <b>Electrical Egg.</b> Of uranium glass, twelve inches high.....	10 00
5392. <b>Electrical Egg.</b> Of uranium glass, sixteen inches high.....	13 00
5395. <b>Gassiot's Cascade.</b> Of plain glass, goblet at top four inches in diameter.....	2 50



	PRICE
5396. Gassiot's Cascade. Of uranium glass, four inches in diameter.....	\$3 50
5397. Gassiot's Cascade. Of uranium glass, five inches in diameter.....	4 00
5398. Gassiot's Cascade. Of uranium glass, five and a half inches in diameter.....	5 00
5399. Illuminating Egg Stand. Of wood, with metal connections.....	2 00
5400. Block of Uranium Glass. For use under the exhausted receiver of an air-pump.....	2 50
5401. Block of Uranium Glass. Similar to No. 5400, but in neat case.....	4 00

## SECTION VI.—ON SUNDRY ACCESSORIES TO ELECTRICAL INSTRUMENTS.

5410. Brass Chain. For connections, per yard.....	20
5411. Copper Wire. Insulated with gutta-percha, per yard.....	25
5413. Amalgam. Per bottle.....	50
5420. Tin Foil. For coatings, per square foot.....	15
5421. Glass Plate. Twelve inches in diameter, center drilled and edges ground.....	
Prices of all glass plates vary very much, and will be given by letter when desired. ....	
5422. Glass Plate. Similar to No. 5421, but sixteen inches in diameter..	
5423. Glass Plate. Similar to No. 5421, but twenty inches in diameter....	
5424. Glass Plate. Similar to No. 5421, but twenty-four inches in diameter. ....	
5425. Glass Plate. For Holtz's Machine, twelve inches in diameter, center drilled, edges ground.....	
5426. Glass Plate. Similar to No. 5425, but sixteen inches in diameter....	
5427. Glass Plate. Same as above, twenty inches in diameter.....	
5428. Glass Plate. Same as above, twenty-four inches in diameter.....	

## SECTION VII.—GALVANIC BATTERIES.

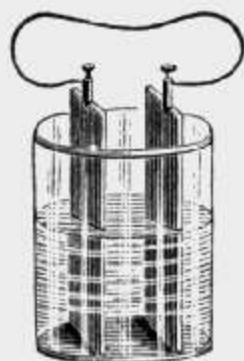

5460.

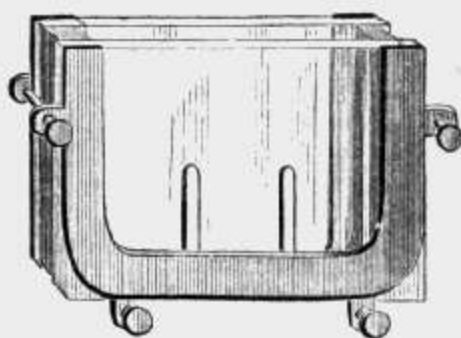

5461.



5462.

5460. Simple Galvanic Cell. A plate of copper, another of zinc, with connecting wires and glass cell.....	2 50
5461. Simple Galvanic Cell, for projection.....	5 50
5462. Volta's Column Battery.....	15 00

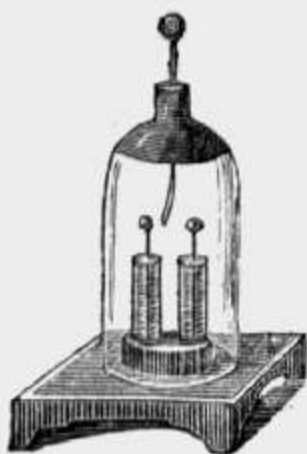

5465.



5466.

- |  | PRICE   |
|--|---------|
| 5463. <b>Zamboni's Pile.</b> 1000 elements.....  | \$15 00 |
| 5465. <b>Bohnenberger's Electroscope.</b> Pair of Zamboni's Piles, connected at base and terminated at top by brass balls. The gold leaf is equally attracted by the opposite poles, and remains in equilibrium. But if an excited body be approached to the outer ball of the electroscope, the gold leaf instantly diverges from its neutral position. This is doubtless the most delicate electroscope constructed, while the piles remain in good order..... | 40 00   |
| 5466. <b>Apparatus for Continuous Rotation.</b> Pair of Zamboni's Piles, connected at base and terminated at top by brass balls. A very light needle, terminated by strips of foil, is balanced upon a needle-point so as to rotate. The alternate attractions and repulsions of the two opposite poles keep the needle in rotation for a long time. The whole is covered with a glass shade.....  | 40 00   |

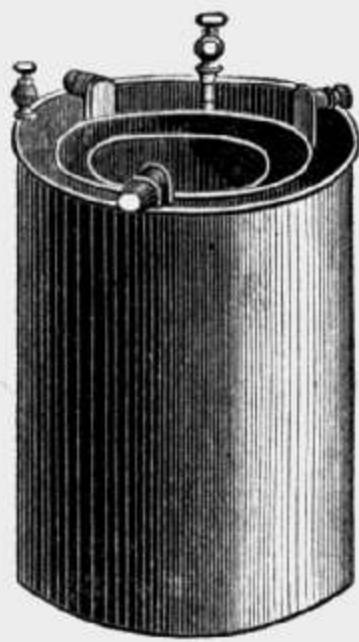

5467.

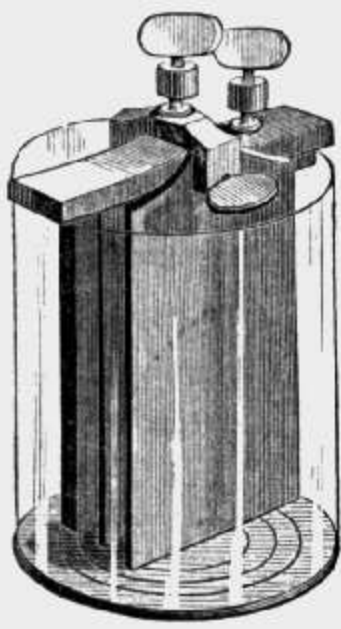

5468.

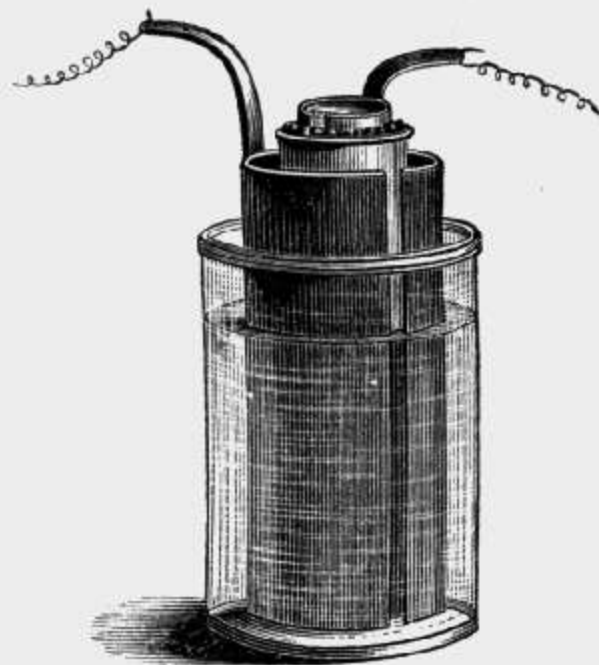

5470.

- |  |      |
|--|------|
| 5467. <b>Sulphate of Copper Battery.</b> Double cell of copper, supporting cell of zinc by means of wooden insulators. Cell 9 inches high..... | 6 00 |
| 5468. <b>Smee's Battery.</b> Platinized silver electrode, two inches by four. Cell of glass.....   | 3 50 |
| 5469. <b>Smee's Battery.</b> Platinized silver electrode, four inches by eight. Cell of glass.....   | 6 00 |
| 5470. <b>Daniell's Battery.</b> Half-gallon cell.....  | 5 00 |



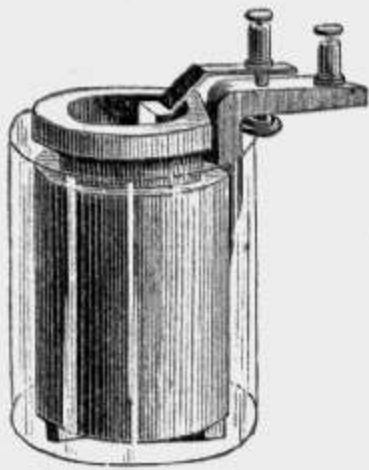

5475.

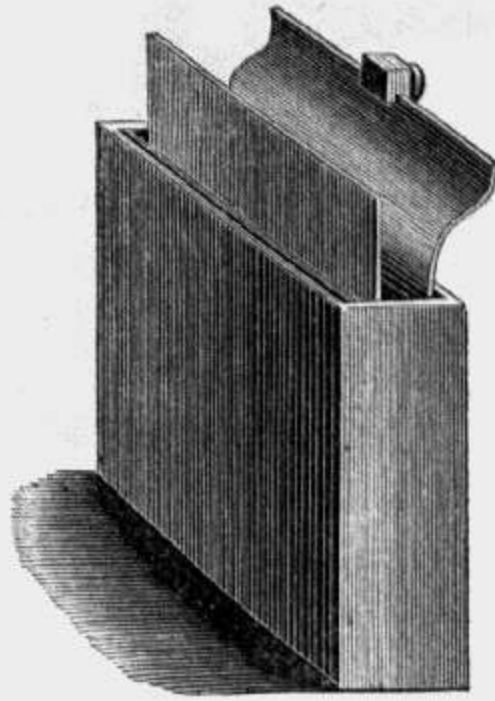

5476.

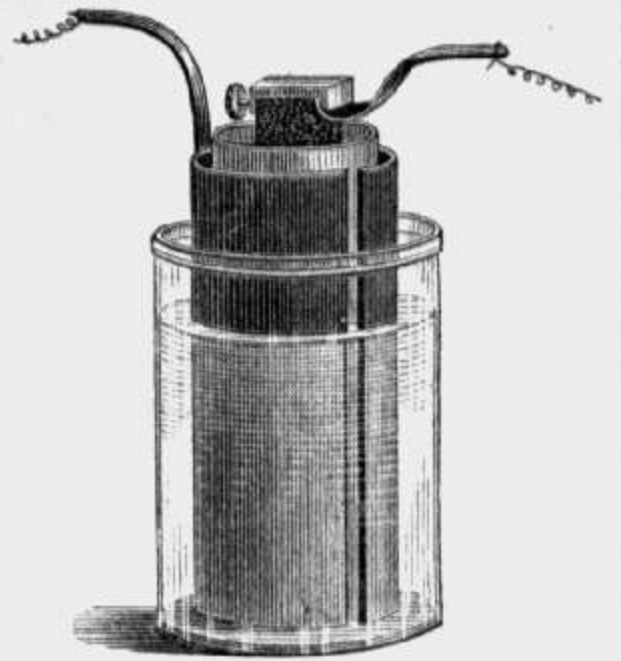

5477 and 5478.

	PRICE
5475. <b>Grove's Battery.</b> Ordinary form. Platinum electrode one inch by three.....	\$2 50
5476. <b>Grove's Battery.</b> Improved form. Flat cell of hard rubber. Platinum, 6 inches long by 2½ inches wide.....	5 50
5477. <b>Bunsen's Battery.</b> Half-gallon cell.....	3 50
5478. <b>Bunsen's Battery.</b> Gallon cell.....	5 00

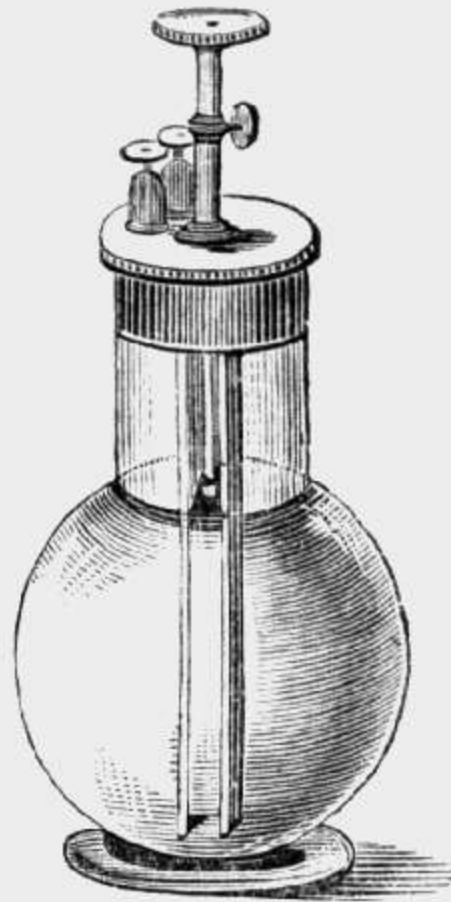

5479.

5479. <b>Bichromate of Potash Battery.</b> Bottle form. This is the most convenient and powerful of all batteries for the lecture table. The zinc electrode can be raised out of the solution when not in use, and thus adjusted the cell can remain for weeks without any action, if desired, and be ready at a moment's notice. Perhaps one of the best proportions for the solution is as follows : One gallon of water, one pound of bichromate of potash, and from half-pint to a pint of sulphuric acid, according to the energy of action desired. A small quantity of nitric acid added to the solution increases the constancy of the battery. Half-pint cell .....	2 00
5480. <b>Bichromate of Potash Battery.</b> Pint size.....	4 00
5481. <b>Bichromate of Potash Battery.</b> Quart size.....	5 00
5482. <b>Bichromate of Potash Battery.</b> Half-gallon size.....	6 50



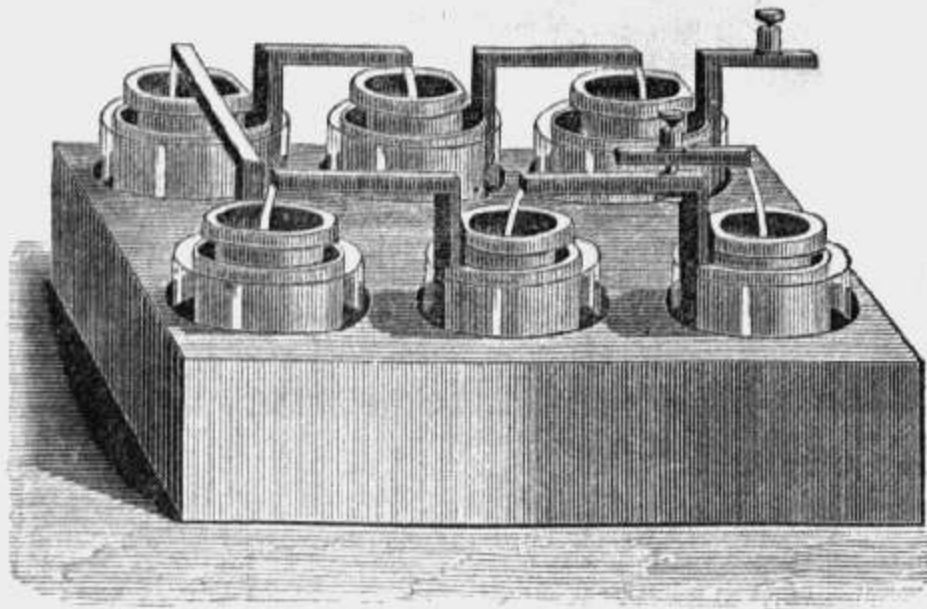

5500.

	PRICE
5500. <b>Grove's Battery.</b> Similar to No. 5475. Set of six cells in neat tray.	\$20 00
5501. <b>Grove's Battery.</b> As above, but set of nine in neat tray.....	30 00
5505. <b>Grove's Battery.</b> Improved form. Similar to No. 5476, set of ten in neat tray.....	52 50
5506. <b>Grove's Battery.</b> Improved form. Similar to No. 5476, fifty cells, in neat tray for the electric light.....	250 00
5508. <b>Bunsen Battery.</b> Set of fifty cells, No. 5477.....	150 00
5509. <b>Bunsen Battery.</b> Set of fifty cells, No. 5478.....	225 00
5512. <b>Bichromate Battery.</b> Set of twenty-five cells, No. 5482.....	150 00
5513. <b>Bichromate Battery.</b> Set of fifty cells, No. 5482.....	225 00
5514. <b>Dipping Battery.</b> Set of three cells, each having 3 zincs and 4 carbons, all 5 inches by 9. Mounted on a strong frame with chain and catch so as to be raised all at once.....	50 00

SECTION VIII.—THE GALVANOMETER AND ELECTRICAL MEASUREMENT.

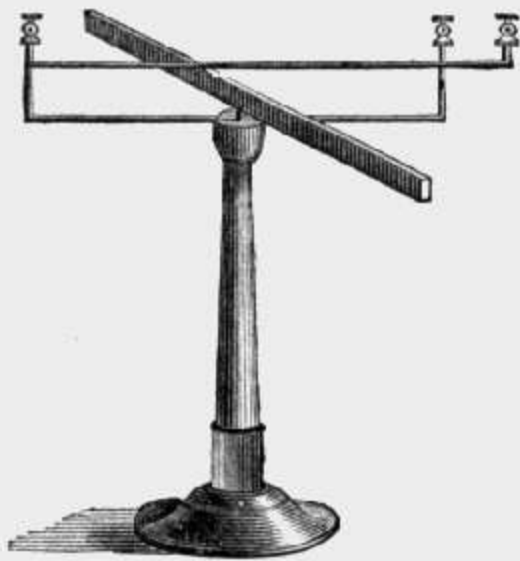

5535 and 5536.

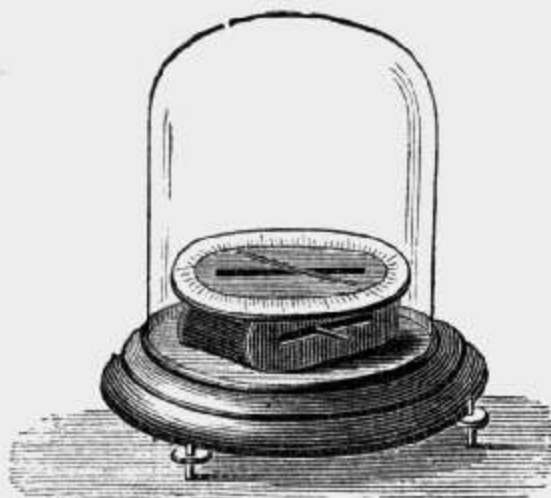

5538.

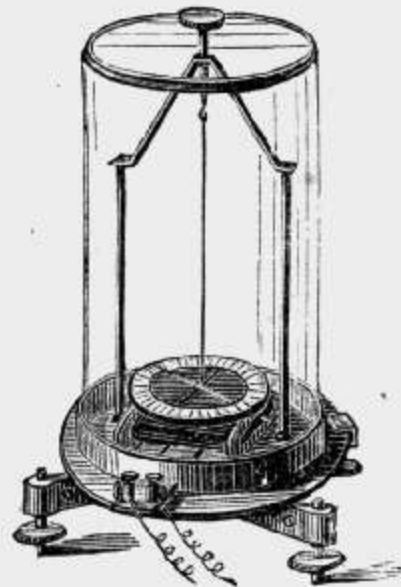

5539 and 5540.

5535. <b>Apparatus to Illustrate Oersted's Law.</b> Magnet eight inches long.	5 50
5536. <b>Apparatus to Illustrate Oersted's law.</b> Magnet fifteen inches long	10 00
5537. <b>Galvanometer.</b> Simple form, with single needle suspended upon a needle point at center.....	5 00
5538. <b>Galvanometer,</b> with astatic needle; on rosewood base, with leveling screws, graduated circle, and glass cover.....	15 00
5539. <b>Galvanometer.</b> Similar to No. 5339, but with posts to suspend the needle by a filament of unspun silk, an adjustment for placing the zero of the scale in the axis of the coil, and leveling screws.....	20 00
5540. <b>Galvanometer.</b> Similar to No. 5539, but with helix for use in thermo-electric experiments.....	20 00

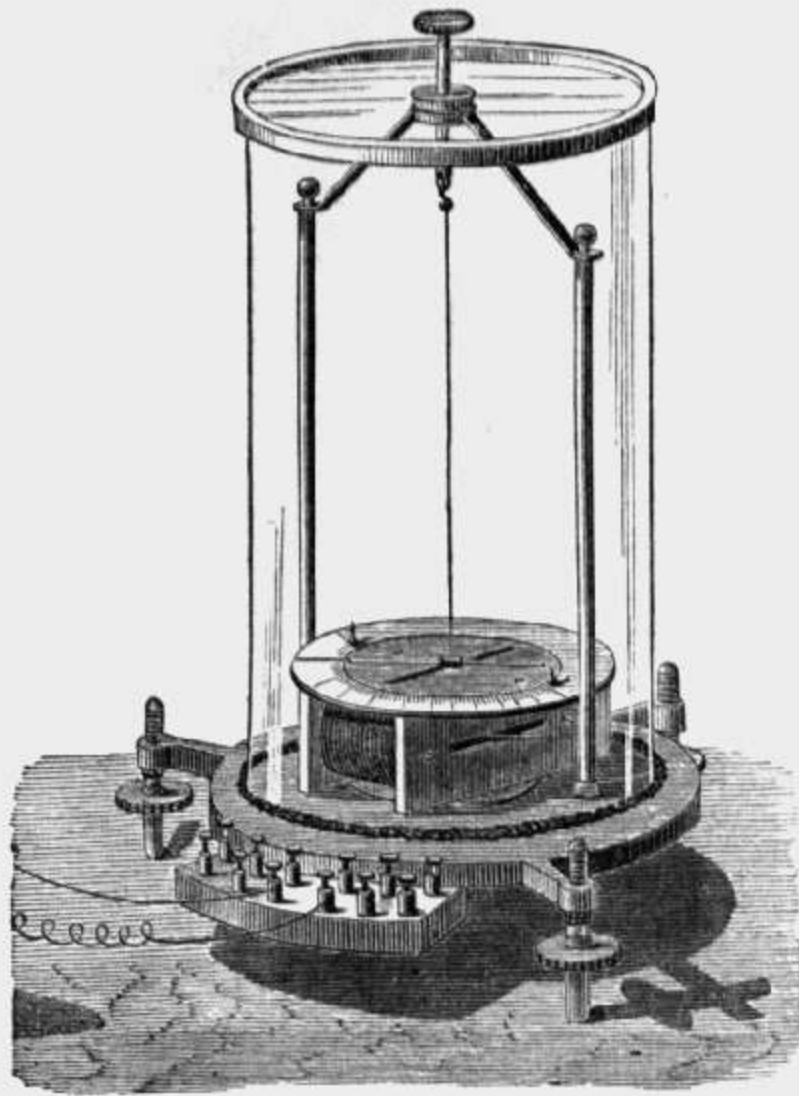

5543.

	PRICE
5542. <b>Differential Galvanometer.</b> For testing the resistances of batteries, wires, etc, etc. On mahogany levelling stand, with glass cover. Needles suspended by fibre of unspun silk.....	\$25 00
5543. <b>Queen's Universal Galvanometer.</b> Rosewood base, with levelling screws, astatic needles, suspended from brass arm by a fibre of unspun silk ; with arrangement for adjusting the zero of the scale to the axis of the coils. Convertible by a moment's adjustment, from an ordinary <i>quantity</i> galvanometer, into one for <i>intensity</i> , or into a differential galvanometer for either <i>intensity or quantity</i> .....	60 00
5550. <b>Small Light Mirror.</b> With wire mounting, to be attached to either of Nos. 5539, 5540, or 5543, for use in projection.....	5 00
5551. <b>Tangent Galvanometer.</b> Single ring.....	30 00
5558. <b>Copy of a British Association Unit, or Ohm, as issued by the Committee</b> .....	30 00
5560. <b>Bradley's Tangent Galvanometer, with three coils, Nos. 2, 3 and 4.</b>	50 00
5561. <b>Bradley's Tangent Galvanometer, with four coils, Nos. 1, 2, 3 and 4.</b>	85 00
5562. <b>Bradley's Rheostat, with resistance from <math>\frac{1}{100}</math> of an ohm to 2111 ohms.</b>	85 00
5563. <b>Bradley's Rheostat, with resistance from <math>\frac{1}{100}</math> of an ohm to 10111 ohms.</b>	175 00
5564. <b>Bradley's Complete Apparatus for Electric Measurement.</b> Consisting of Tangent galvanometer No. 5560 and Rheostat No. 5562..	125 00
5565. <b>Bradley's Complete Apparatus for Electric Measurement.</b> Consisting of Tangent galvanometer No. 5561 and Rheostat No. 5563.....	250 00

The instruments Nos. 5560 to 5565 are intended for accurately determining the electro-motive force, resistance and strength of batteries and resistance of conductors ; for locating faults, breaks, and crosses on telegraph lines or cables ; for measuring the amount of any metal deposited in a given time in Electro-plating ; and for determining the specific conductivity of metals.

The Coil No. 1 of 5561 is for currents of high intensity, No. 4 for those of great quantity, Nos. 2 and 3 for intermediate currents.



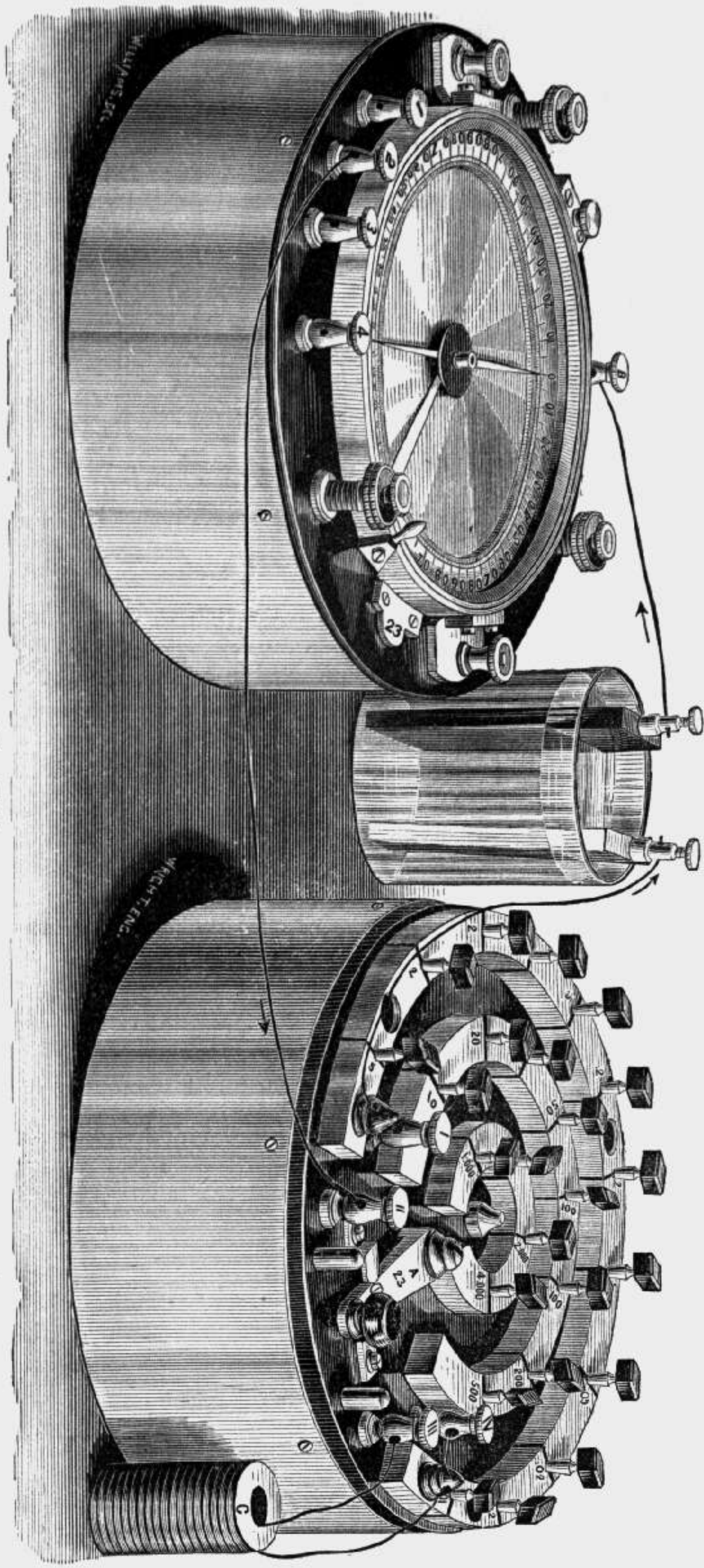

No. 5565.



SECTION IX.—OF INSTRUMENTS ILLUSTRATING THE HEATING EFFECTS OF DYNAMICAL ELECTRICITY.

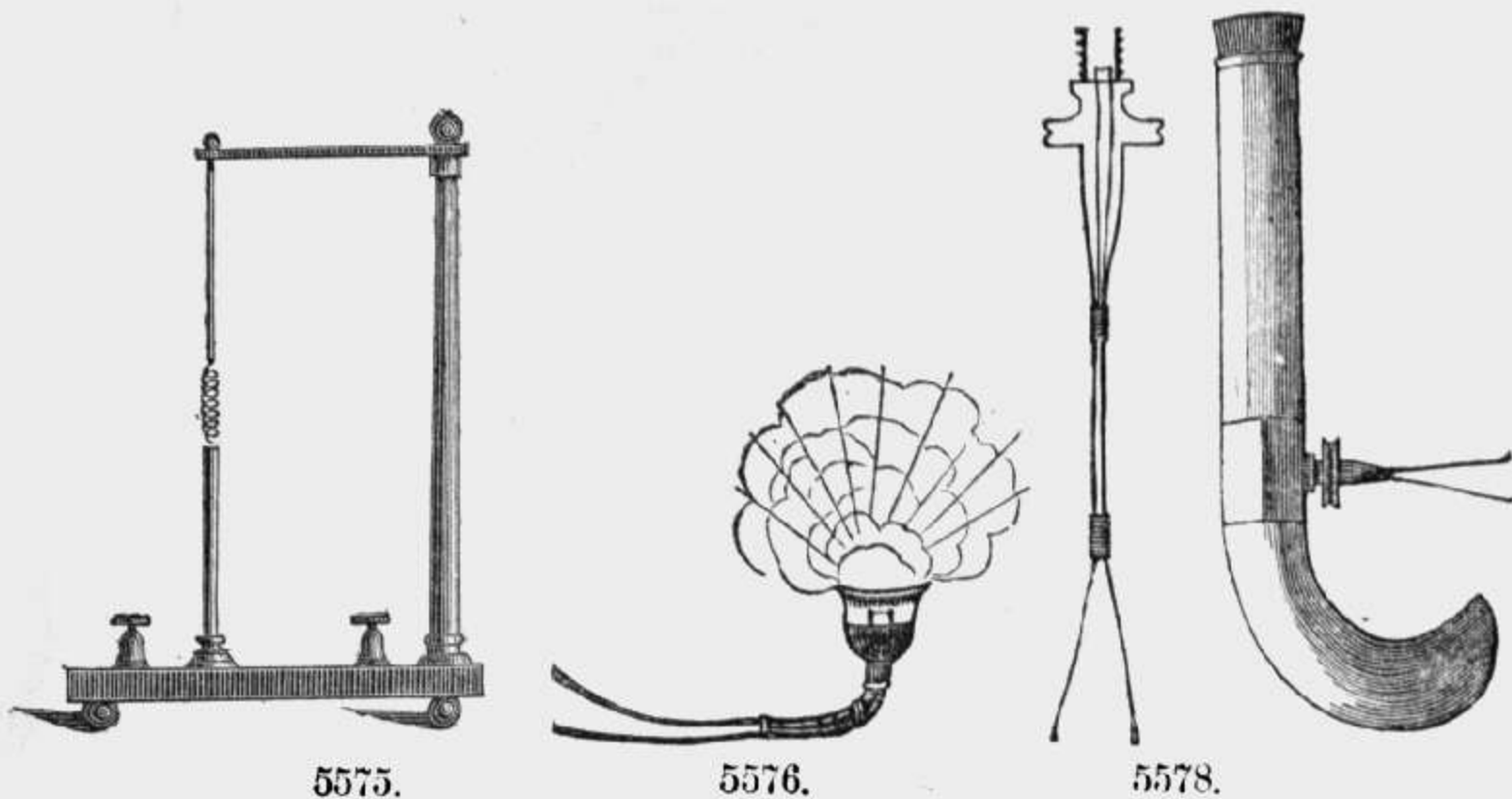

	PRICE
5575. <b>Galvanic Lamp.</b> Of platinum wire in coil, with vertical support of brass, on a neat polished base of mahogany.....	\$5 00
5576. <b>Powder Cup.</b> Of brass, with platinum wire in coil.....	1 50
5577. <b>Powder Cup.</b> Of brass, with handle of wood, and an extra supply of platinum wire.....	5 00
5578. <b>Voltaic Pistol.</b> Of brass, strongly made and neatly finished.....	8 00

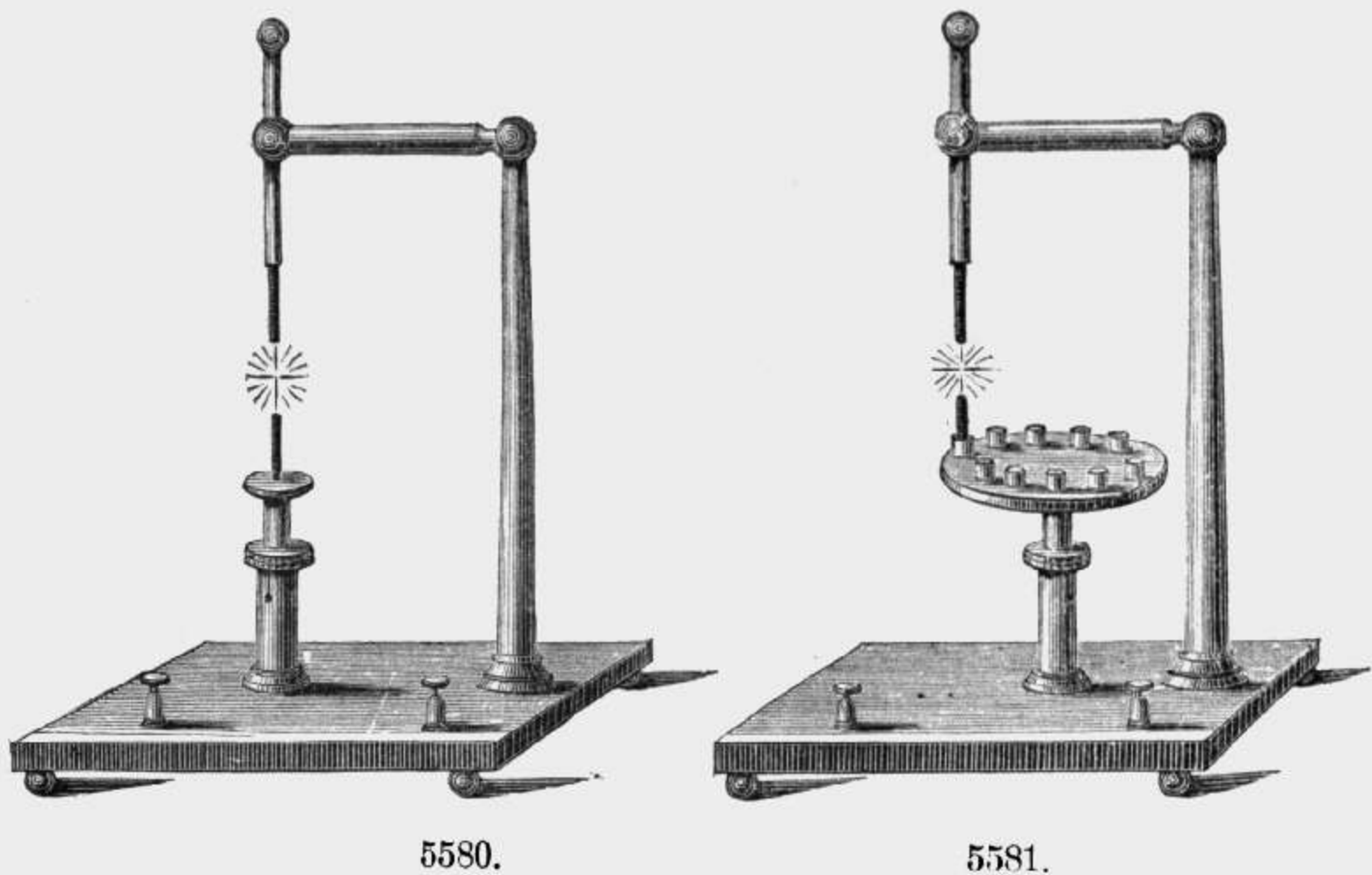

5579. <b>Simple Electric Lamp.</b> Base of wood, arms and holders of brass..	12 00
5580. <b>Simple Electric Lamp.</b> Base of hard rubber, post, arm, and carbon holders of brass.....	22 50

- |  | PRICE   |
|--|---------|
| 5581. <b>Compound Electric Lamp.</b> For use in projection of spectra. Base of hard rubber, post, arm and metal holders of brass. The lower holder consists of a disc of brass with cups for ten different substances, which can be thus rapidly brought in succession into circuit and volatilized..... | \$30 00 |
| 5582. <b>Compound Electric Lamp.</b> Similar to No. 5581, but with a second disc holding 10 carbons, instead of the single upper carbon holder of 5581. The metals can thus be quickly volatilized without mixture of their spectra.....   | 40 00   |

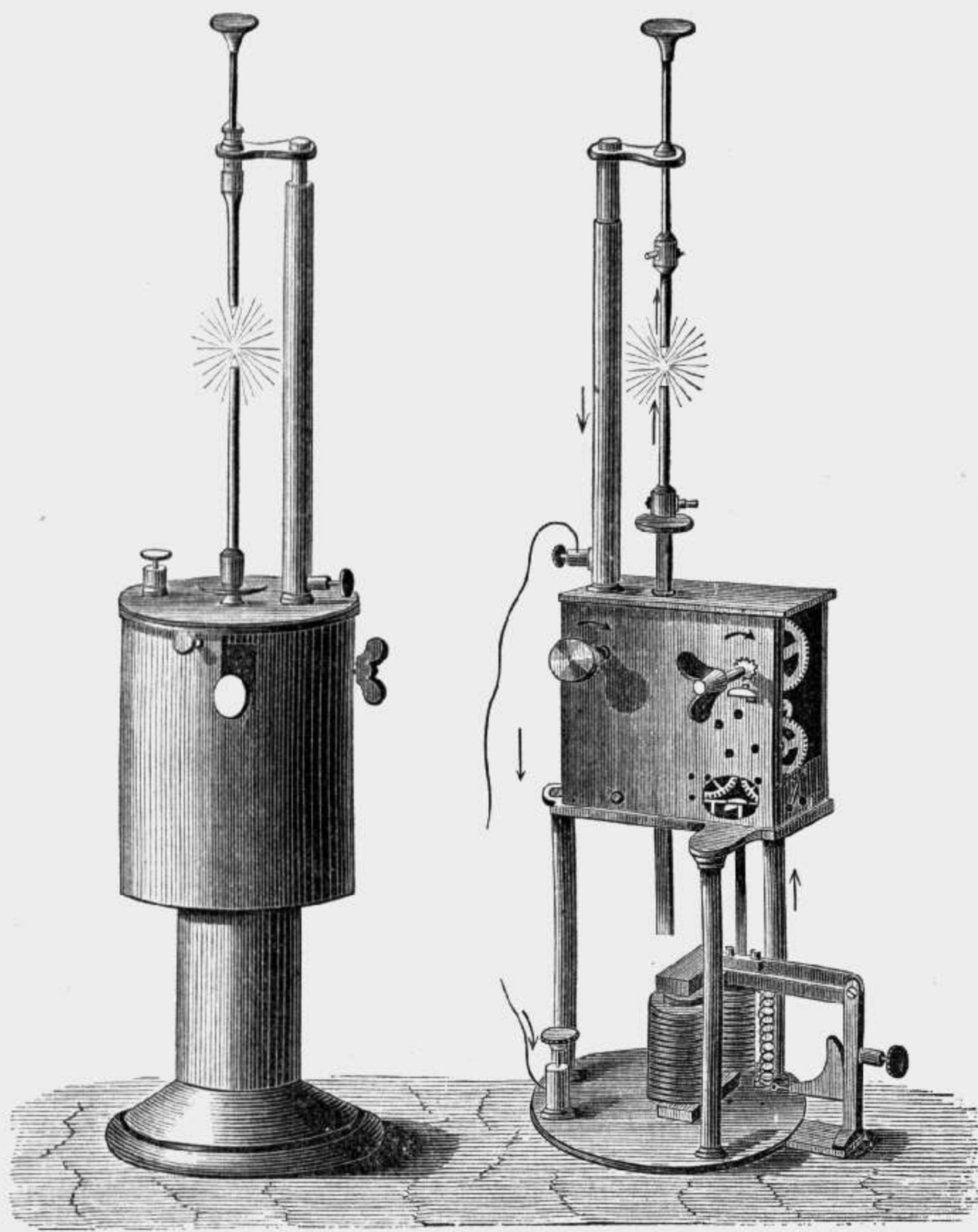

5587.

5588.

- |  |        |
|--|--------|
| 5585. <b>Electric Light Regulator.</b> Simple form (Browning's).....                       | 30 00  |
| 5586. <b>Electric Light Regulator.</b> Large model (Browning's).....                       | 95 00  |
| 5587. <b>Electric Light Regulator,</b> with clock-work. (Duboscq's).....                   | 120 00 |
| 5588. <b>Electric Light Regulator,</b> with double clock-work. Foucault's arrangement..... | 215 00 |

The batteries needed for use with the electric lamps, Nos. 5579 to 5588 inclusive, are as follows:

For Nos. 5579 and 5580, the compound battery No. 5505 or ten cells of No. 5477.

For Nos. 5581 and 5582, two of the compound batteries No. 5505 or twenty cells of No. 5477.

For No. 5585, the compound battery No. 5505.

For Nos. 5586, 5587 and 5588, the compound batteries Nos. 5506, 5508 or 5509. The first is the best.

### SECTION X.—OF ELECTROLYSIS.

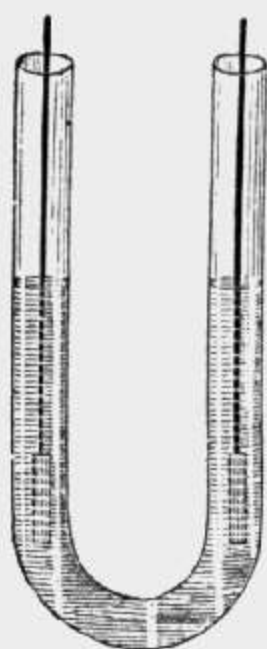

5600.

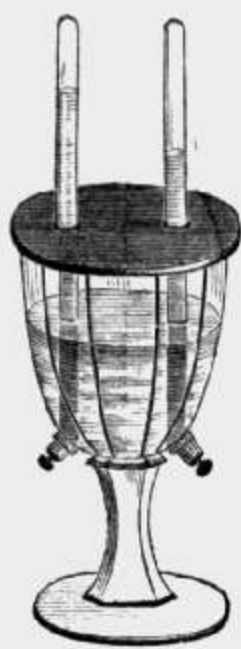

5601.

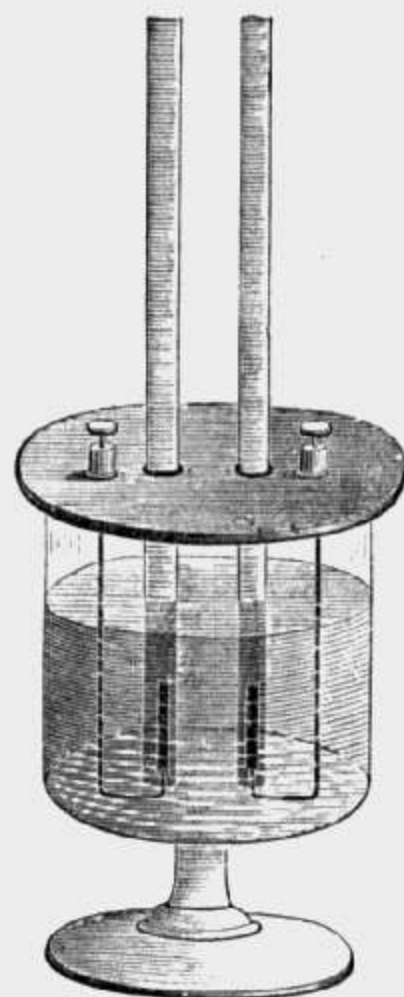

5602.

- |  | PRICE  |
|--|--------|
| 5600. <b>U Tube of Glass.</b> Arms 12 inches long. Insulated copper wires with bar electrodes of platinum.....   | \$2 00 |
| 5601. <b>Decomposing Water Apparatus.</b> Glass goblet 6 inches high, and 3½ inches in diameter at top, with binding screws, platinum bar electrodes, and bell tubes for the gases.....  | 3 50   |
| 5602. <b>Decomposing Water Apparatus.</b> Glass goblet seven inches high and four and a half inches in diameter at top, with binding screws, platinum electrodes, and fine, graduated bell tubes for the gases.....              | 8 00   |
| 5603. <b>Decomposing Tank.</b> For use in projecting the results of electrolysis upon a screen. Plate glass sides, improved brass clamps, binding screws, platinum bar electrodes, and small glass bell tubes for the gases..... | 7 50   |
| 5605. <b>Chemical Voltmeter.</b> Plain glass goblet, 7 inches high, platinum bar electrodes, binding screws, and single graduated glass bell.....  | 6 00   |



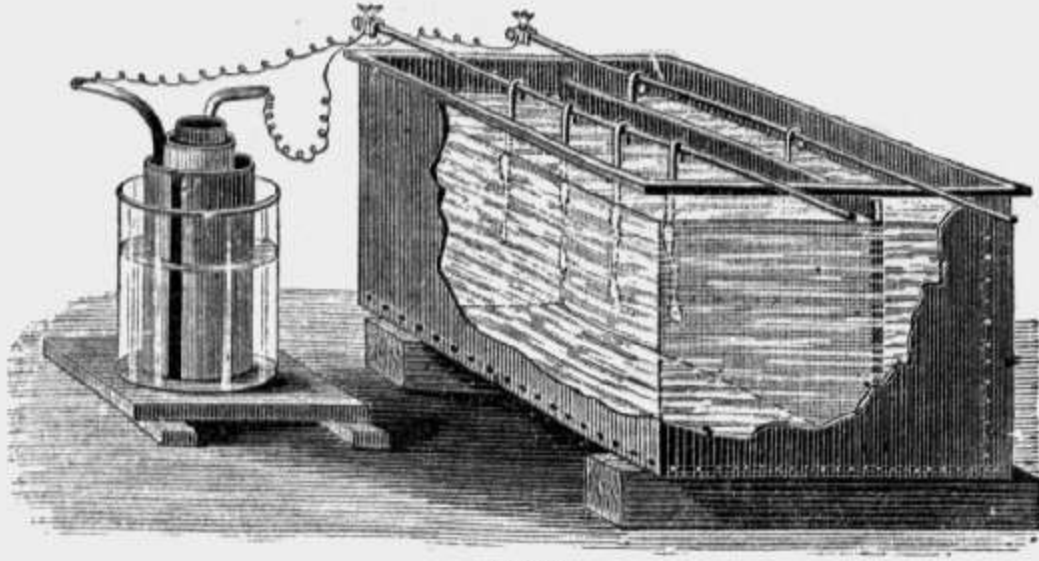

5608.

5608. **Apparatus for Electro-Plating.** Tank of mahogany, pair of bars with binding screws, and Daniell's cell, No. 5470..... **PRICE**  
 \$15 00

SECTION XI.—ILLUSTRATING THE LAWS OF CURRENTS.

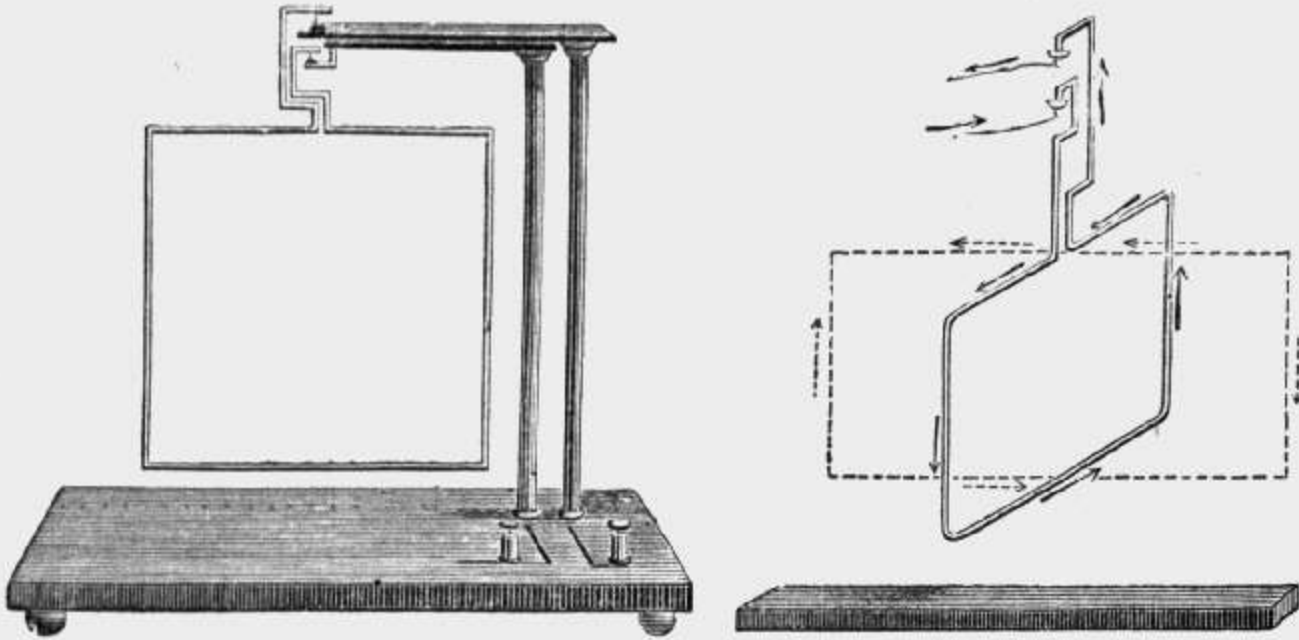

5625.

5625. **Ampere's Frame.** Base of polished mahogany, posts and arms of brass, figures of copper, twenty inches in length or diameter, consisting of solenoid, astatic combination, square, and circle. With strong bar magnet..... **30 00**

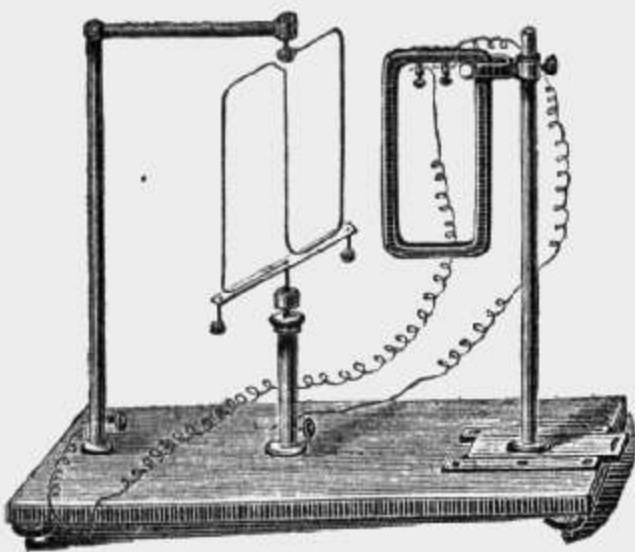

5626.

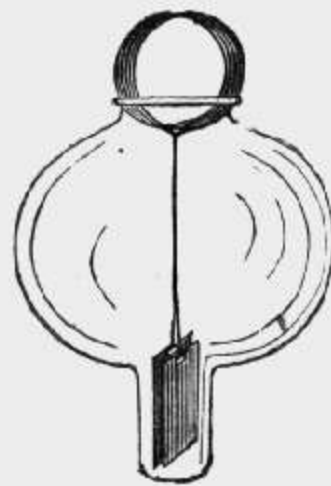

5628.

	PRICE
5626. <b>Ampere's Table.</b> Polished table of mahogany, two vertical posts of brass, with mercury cups at base and top for sustaining the wire forms; two forms twenty inches square of heavy wire, one to show attraction, the other repulsion. With intensifier. See cut p. 95...	\$40 00
5627. <b>Solenoid.</b> Twenty inches long, without frame, of heavy wire, with points for suspension, as in No. 5625.....	4 00
5628. <b>De la Rives' Ring</b> .....	2 25

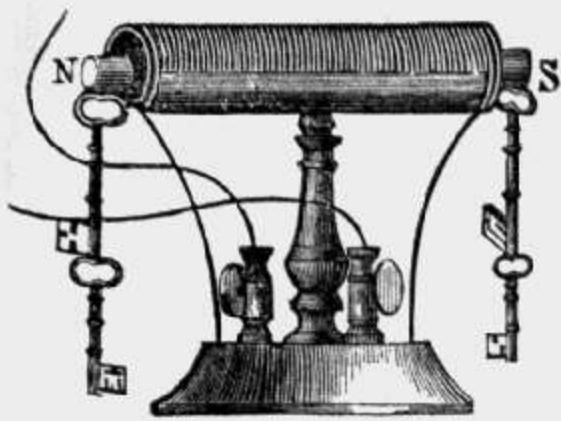

5632.

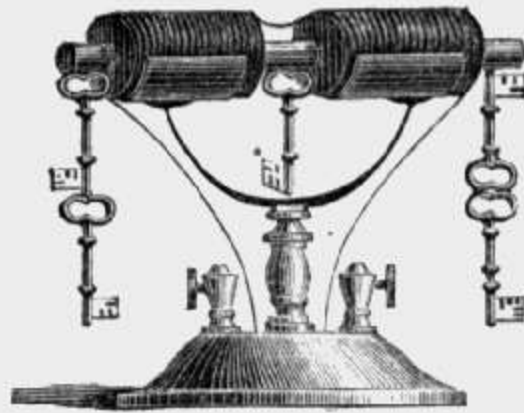

5633.



5635.

5632. <b>Helix on Stand.</b> Base of mahogany, pillar of brass, coil of insulated copper wire, with binding screws, and rod of soft iron.....	4 75
5633. <b>Three-Pole Helix,</b> on stand, as in No. 5632.....	4 75
5634. <b>Horizontal Coil.</b> Twelve inches long, of insulated copper wire, on neat stand, with soft iron bar, similar to No. 5632.....	15 00
5635. <b>Lifting Coil.</b> Four inches long, with soft iron bar.....	4 00

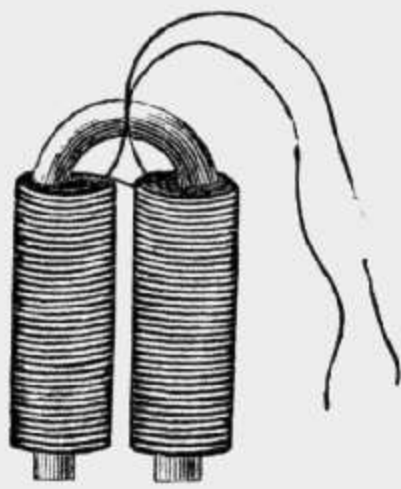

5637 and 5640.

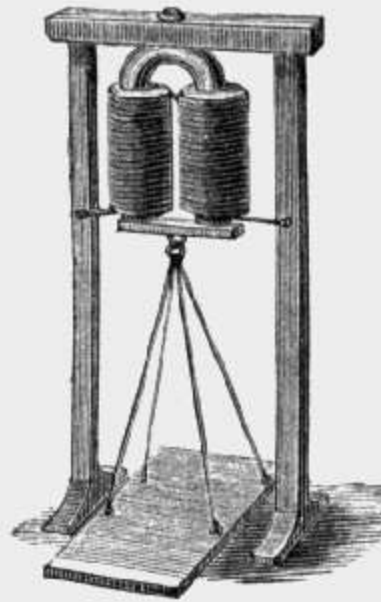

5641.



5645.

5637. <b>Electro-Magnet.</b> Three inches long, sustaining about twenty-five pounds.....	2 00
5638. <b>Electro-Magnet.</b> Four inches long, sustaining about forty pounds...	3 00
5639. <b>Electro-Magnet.</b> Five inches long, sustaining about sixty pounds...	4 00
5640. <b>Electro-Magnet.</b> Six inches long, sustaining about one hundred and twenty pounds.....	5 00
5641. <b>Electro-Magnet.</b> Same as No. 5640, but mounted in strong frame with binding screws and armature with hook.....	12 50



PRICE

5645. **Magic Circle.** Two semicircular soft iron bars, with handles of brass ; a hollow ring of insulated copper wire permits the semicircles to slip into it. . . . . \$5 00
5650. **Polymagnet.** A compound electro-magnet, devised for the purpose of showing to an audience as many as possible of the phenomena of magnetism and diamagnetism. (See Tyndall, Phil. Mag., vol. ix. p. 425.) Consisting of two large horseshoe electro-magnets, a helix of covered copper wire disposed between them, all mounted upon a strong mahogany base, with commutators for the currents, and supports and glass covers for the bodies to be experimented upon . . . . . 200 00
5651. **Apparatus to demonstrate to a large audience that an iron bar is lengthened by the process of magnetization.** Consisting of a strong base of mahogany, with two upright rods of brass three feet long, firmly set in it, and carrying a delicate apparatus consisting of a lever, connected with a mirror by a spiral spring, to magnify the amount of expansion as much as practicable. An iron bar, two feet long, and a coil of wire, eighteen inches long, serve for the magnetic excitation. . . . . 100 00

SECTION XII.—TELEGRAPHIC INSTRUMENTS.

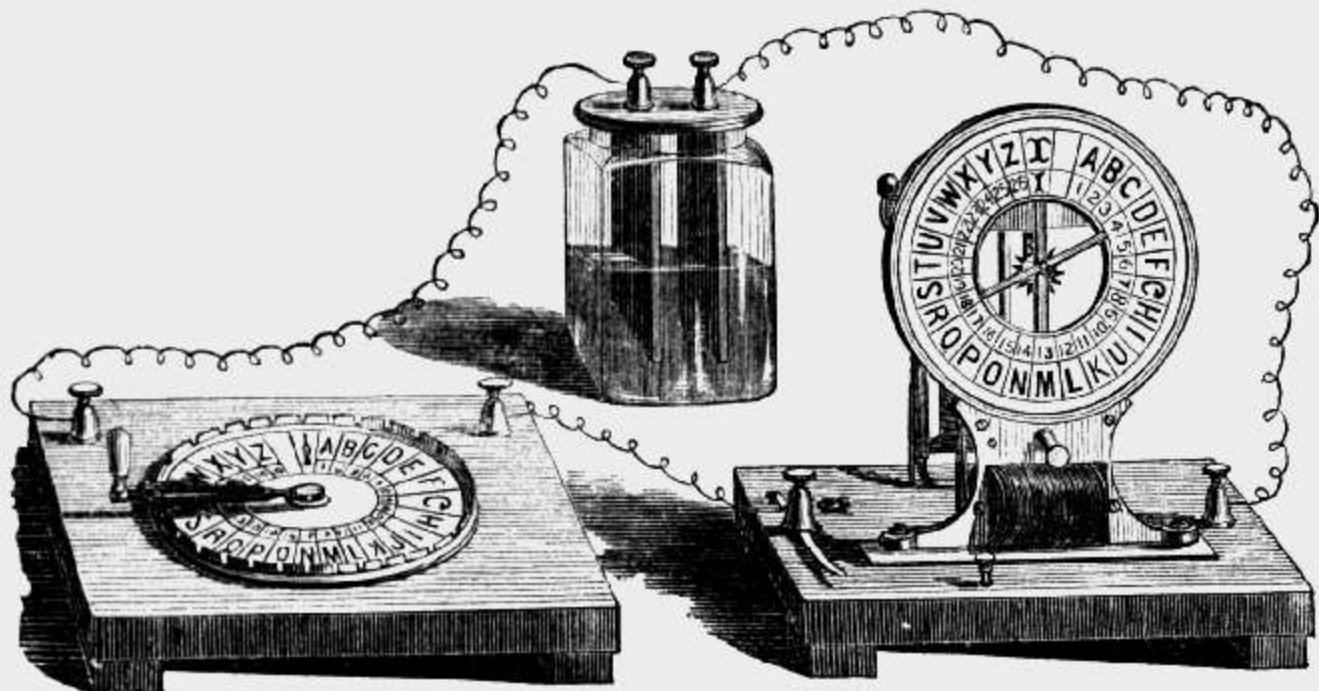

5675.

5675. **Dial Telegraph.** Consisting of a manipulator or crank, with the letters of the alphabet, for sending the signals, a bell and indicator for receiving them, and a small battery for working the instrument ; all packed in a neat box . . . . . 20 00

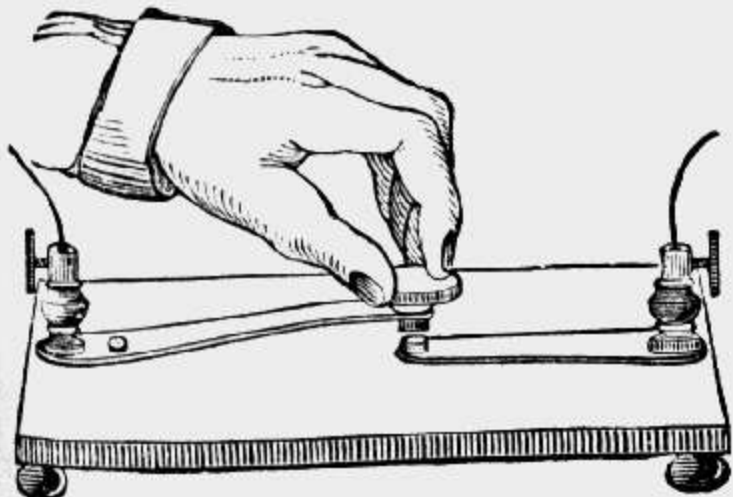

5678.

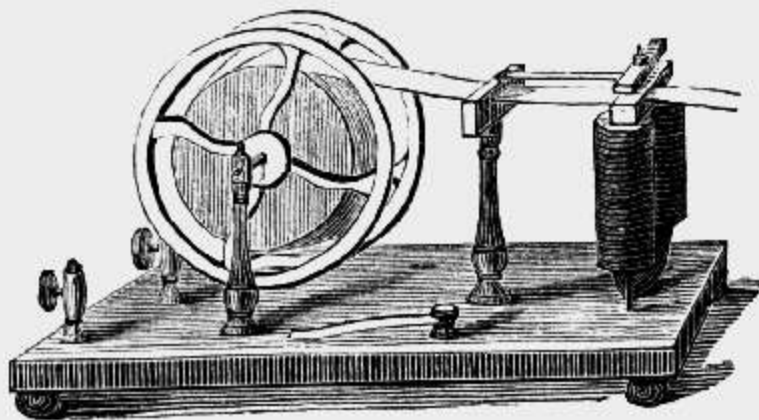

5679.



- |   | PRICE  |
|---|--------|
| 5678. <b>Plain Signal Key</b> for closing and opening circuit at will. Of brass, on polished mahogany base. See cut, p. 97..... | \$2 50 |
| 5679. <b>Plain Receiver</b> (Morse's). Without clockwork, finely finished, on polished mahogany base. See cut, p. 97.....       | 12 00  |

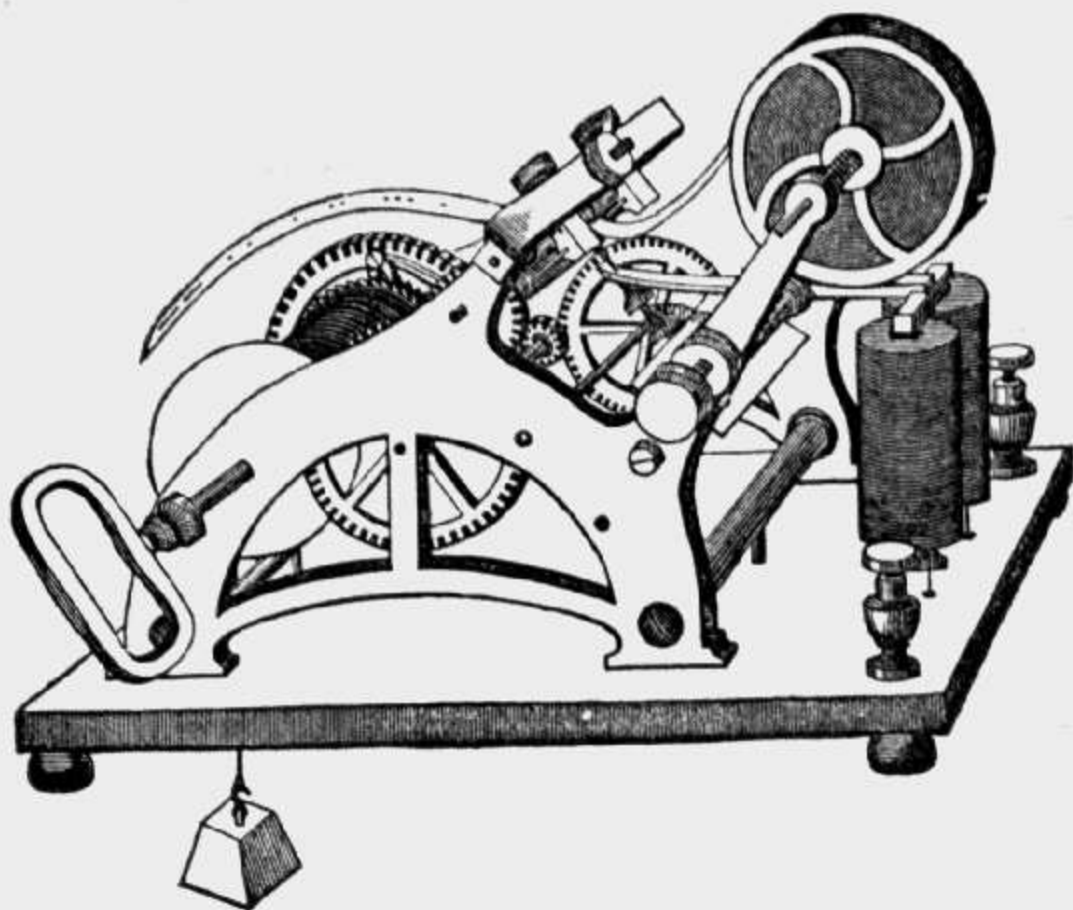

5680.

- |  |       |
|--|-------|
| 5680. <b>Large Receiver</b> (Morse's). With clockwork, finely finished with brass and hard rubber, and mounted on polished rosewood base...  | 50 00 |
| 5681. <b>Sounding Receiver</b> , or "Sounder." The message in this instrument is read directly by the ear, instead of being traced upon the paper, as in Nos. 5679 and 5680.....                                     | 8 00  |
| 5682. <b>Sounder and Key Combined</b> . This little instrument has a switch by which the current is so modified that it can be used either as a Sender or Receiver—a most convenient form for students and amateurs. | 10 00 |

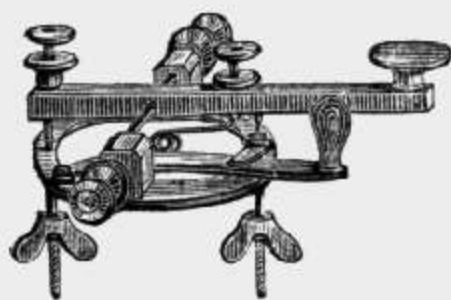

5685.

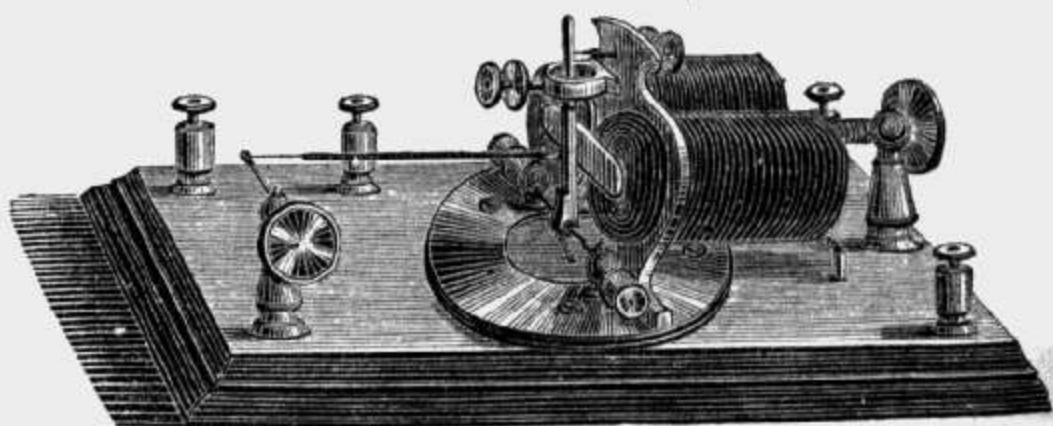

5686.

- |   |       |
|---|-------|
| 5685. <b>Western Union Key</b> . All of brass, neatly finished. This is the form used by the Western Union Telegraph Co.....                | 5 50  |
| 5686. <b>Relay</b> (Morse's). Finely finished, of brass and hard rubber, and mounted on a neatly polished base of rosewood or mahogany..... | 25 00 |

SECTION XIII.—OF INDUCED CURRENTS.

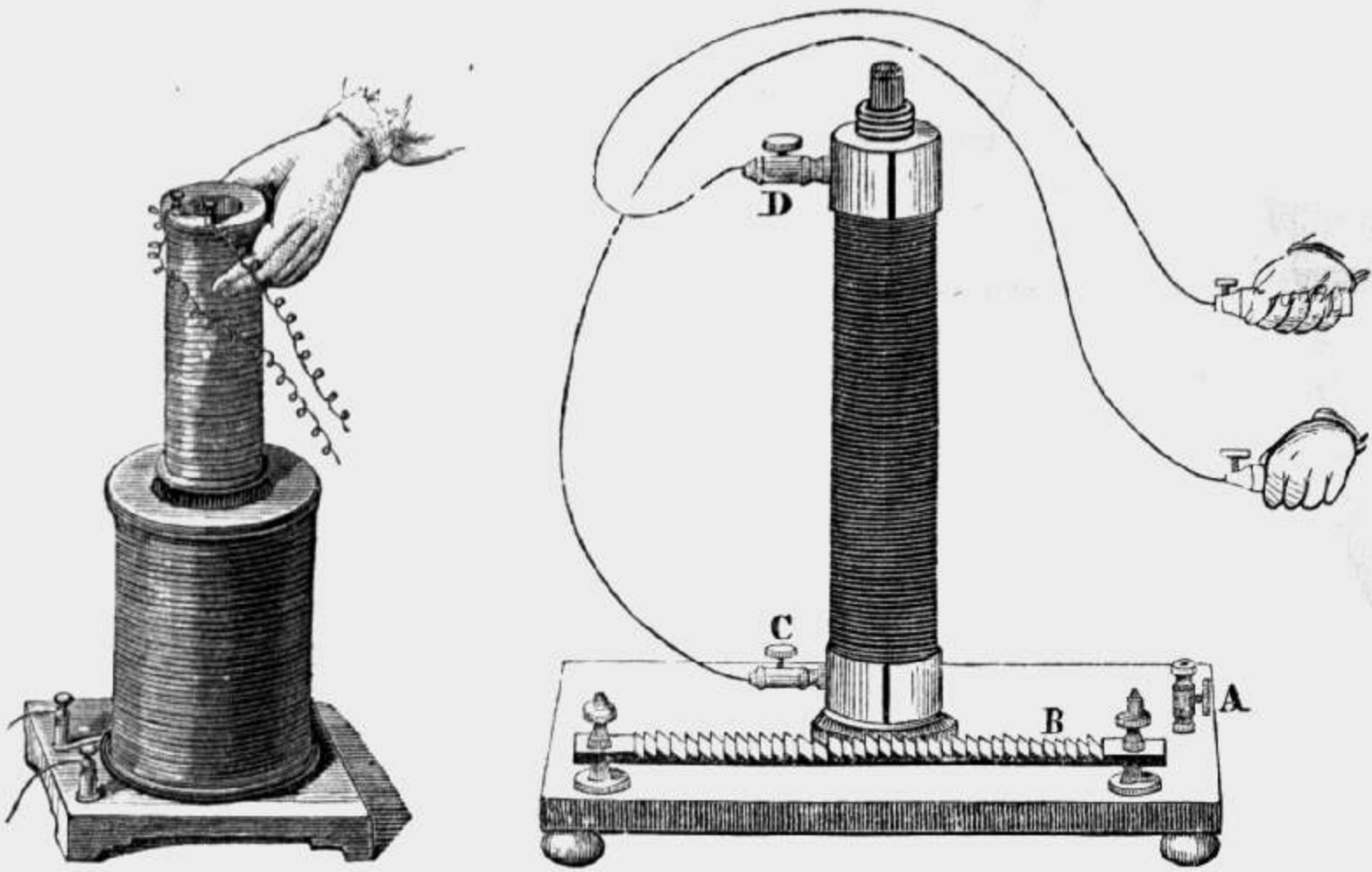

5700.

5701.

- |  | PRICE   |
|--|---------|
| 5700. <b>Primary and Secondary Coils.</b> Mounted on neat mahogany stand, with movable core of soft iron wire, for use with galvanometer...  | \$18 00 |
| 5701. <b>Primary and Secondary Coils.</b> For use in showing the physiological effects of the induced current; furnished with an automatic electro-tome, and also a rasp for slow breaks. .... | 18 00   |
| 5702. <b>Portable Helix for Shocking.</b> Inclosed in a neat mahogany box, with a small cell, having six varieties of current, and a brass insulator for the soft iron core .....              | 18 00   |

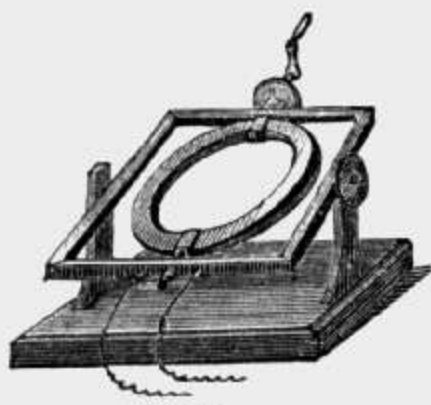

5705.

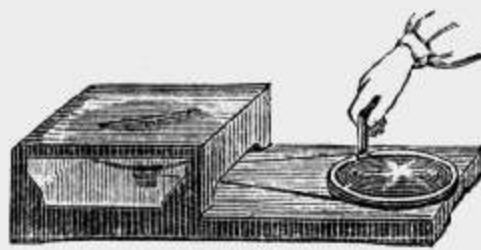

5706.

- |   |       |
|---|-------|
| 5705. <b>Induction Apparatus.</b> To show the induction arising from the action of the earth. Consisting of a spiral of copper wire, arranged to be turned by a crank; a commutator, and a table which can be inclined at any angle by set-screws. .... | 40 00 |
| 5706. <b>Arago's Induction Apparatus.</b> Consisting of a horizontal disc of copper, arranged to be set in rapid rotation, immediately beneath a magnetic needle. ....  | 27 50 |
| 5707. <b>Babbage &amp; Herschel's Induction Apparatus.</b> Consisting of a magnet, arranged to be set in rapid rotation, and a disc of copper supported above the magnet on a delicate pivot. ....  | 27 50 |



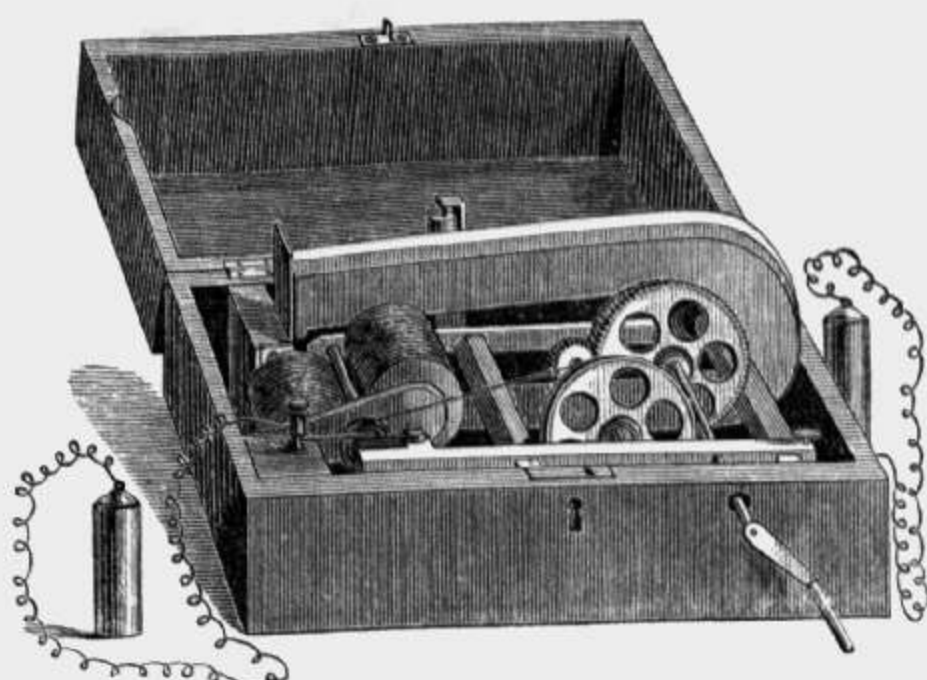

5721.

- |   | PRICE   |
|---|---------|
| 5720. <b>Clark's Induction Machine.</b> For physiological effects. Small model. A single strong magnet, one pair of spirals, for intensity, and a pair of conducting wires with handles. In neat box..... | \$10 00 |
| 5721. <b>Clark's Induction Machine.</b> For physiological effects. Large Model. Two powerful magnets, one pair of spirals, for intensity, and a pair of conducting wires with handles. In neat box.....   | 15 00   |

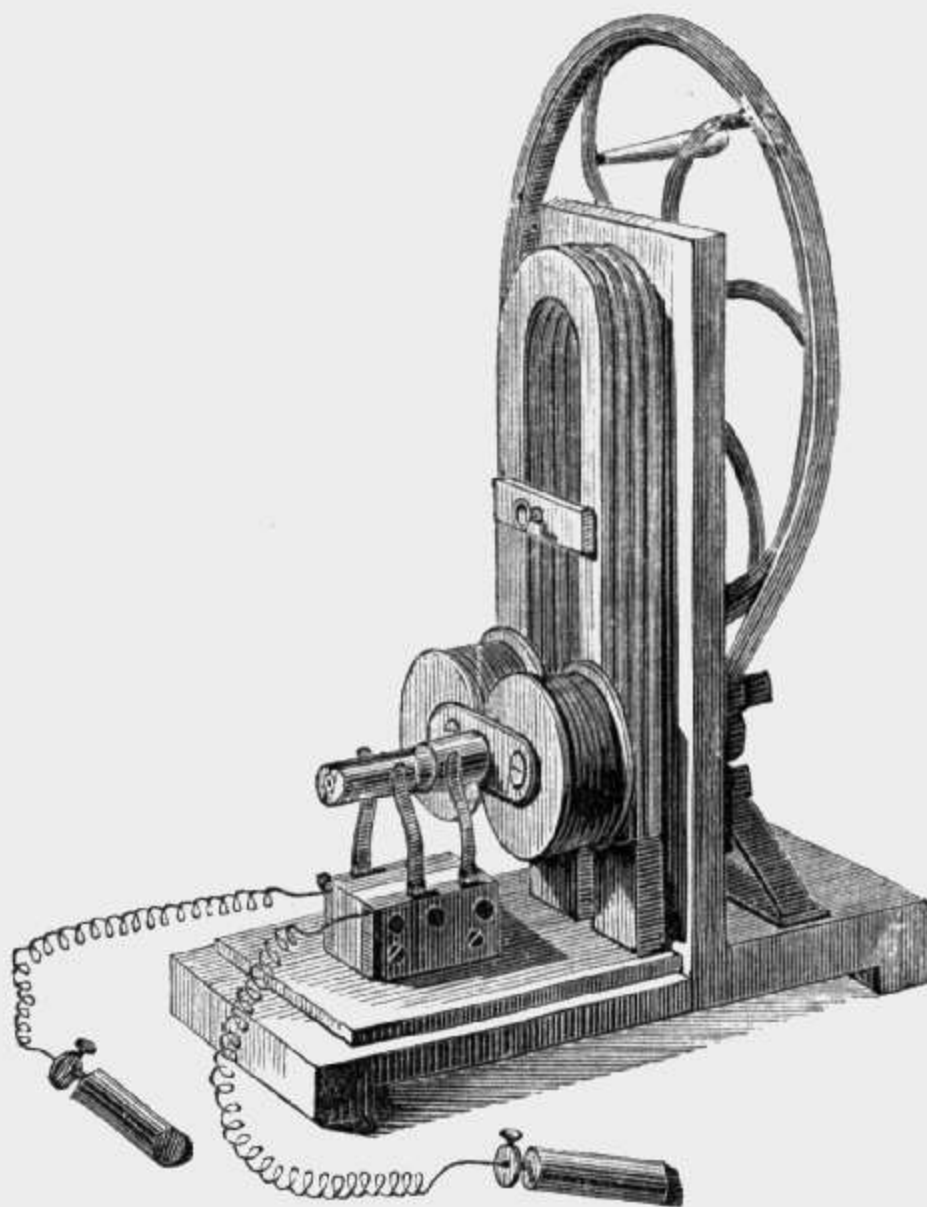

5722.

- |  |       |
|--|-------|
| 5722. <b>Clark's Induction Machine.</b> Grand model. Battery of four powerful magnets, two pairs of spirals, one for intensity and physiological effects, the other for quantity; a commutator, and a pair of conducting wires with handles. Mounted firmly on a strong and neatly polished mahogany base..... | 60 00 |
|--|-------|



SECTION XIV.—THE RUHKORFF, OR INDUCTION COIL.

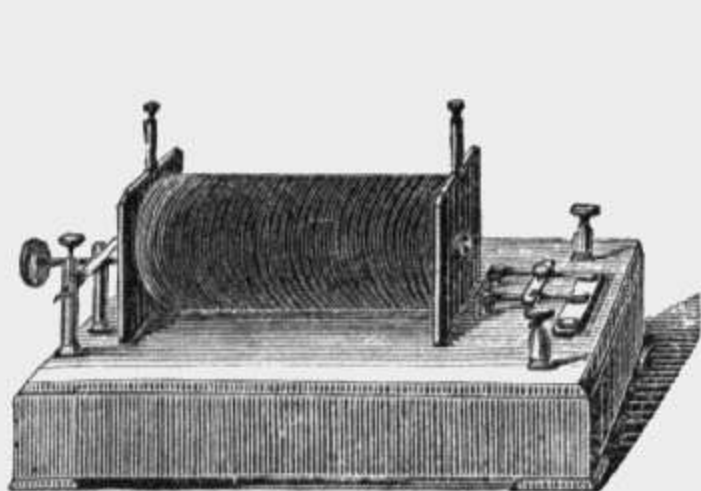

5735-37.

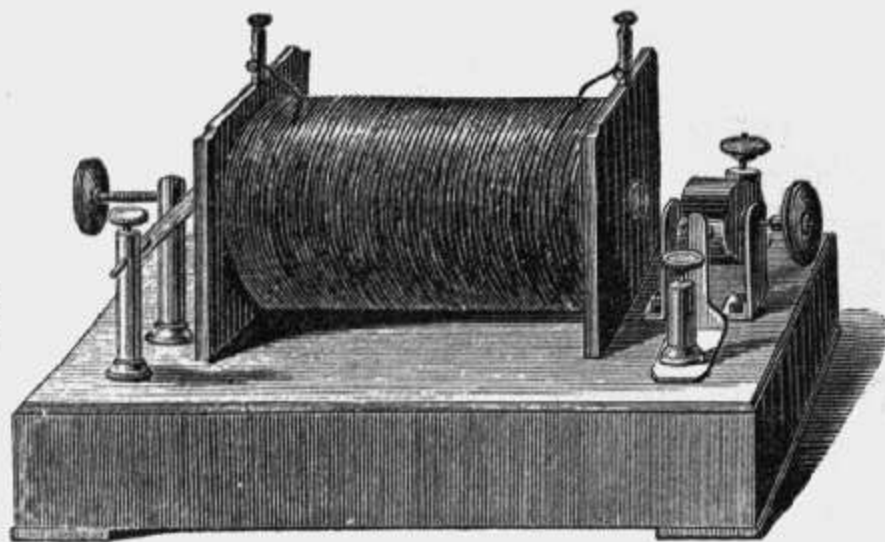

5738-40.

	PRICE
5735. Induction Coil. With automatic break and plain commutator, giving a spark of $\frac{1}{4}$ inch, on neat mahogany base.....	\$10 00
5736. Induction Coil. Similar to No. 5735, but giving spark of $\frac{3}{8}$ inch.....	20 00
5737. Induction Coil. Similar to No. 5735, but giving spark of $\frac{1}{2}$ inch.....	35 00
5738. Induction Coil. Similar to above, but with cylinder commutator, and giving a spark of one inch and a quarter.....	55 00
5739. Induction Coil. Similar to No. 5738, but giving a spark of one and a half inches.....	60 00
5740. Induction Coil. Similar to No. 5738, but giving a spark of two inches.....	90 00
5741. Induction Coil. Similar in style and finish to No. 5738, but with automatic mercurial electrotome, instead of a vibrating spring, giving sparks of four inches.....	200 00
5742. Induction Coil. Similar to No. 5741, but giving sparks of six inches.....	250 00
5743. Induction Coil. Similar to No. 5741, but giving sparks nine inches..	375 00
5744. Induction Coil. Similar to above, but with <i>double</i> automatic mercurial break, and giving sparks of 18 to 20 inches.....	825 00

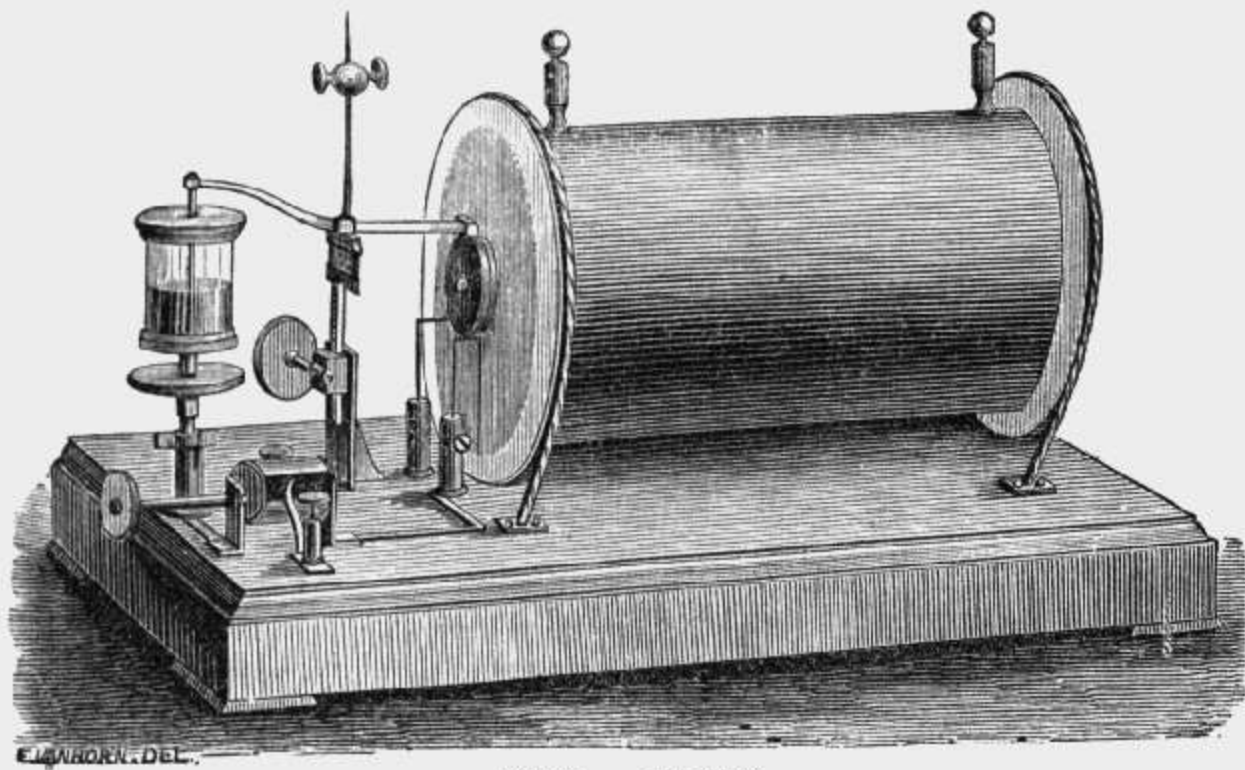

5751 and 5752.

5750. Induction Coil. Highest style of finish, and perfection of construction, with commutator, and automatic break. Spark two inches..	135 00
5751. Induction Coil. Similar to No. 5750, but having Foucault's single mercurial contact breaker. Spark four inches.....	175 00
5752. Induction Coil. Similar to No. 5751, but with spark of six inches...	250 00

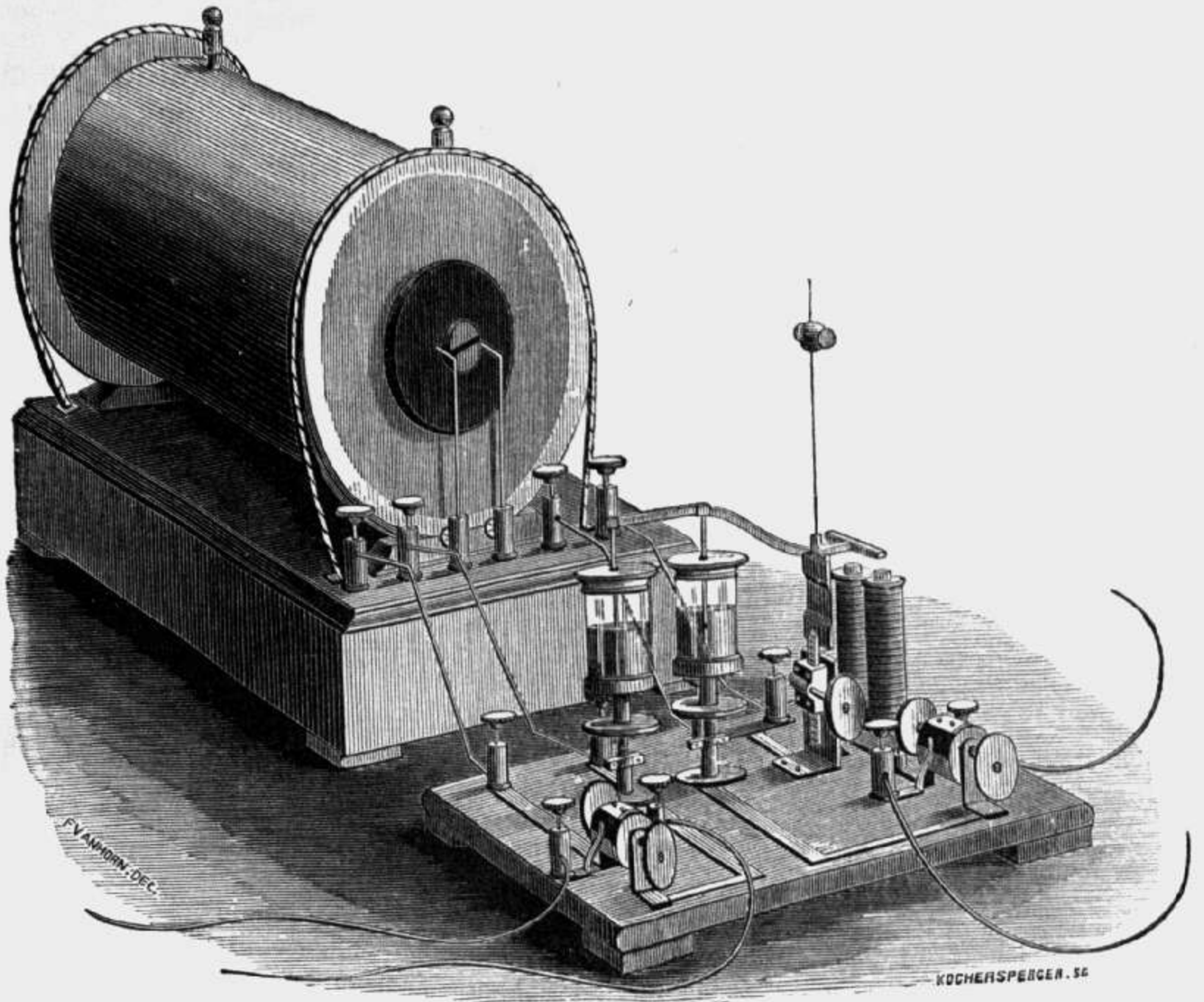

5754 and 5755.

	PRICE
5754. Induction Coil. Of similar finish and construction to Nos. 5750 to 5752 but giving over ten inches spark, and having Foucault's double mercurial contact breaker on a separate stand.....	\$375 00
5755. Induction Coil. Similar to No. 5754, but giving over fifteen inches spark, and having the poles of the secondary on detached supports	600 00

SECTION XV.—OF GEISSLER AND SPECTRUM TUBES.

GEISSLER'S TUBES.

5800. Plain or Spiral Tube, about 6 inches long .....	1 00
5801. Same as 5800, but with bulbs or tube of <i>Uranium Glass</i> , which becomes <i>fluorescent</i> on the passage of the electric discharge.....	1 25
5802. Tube with <b>Uranium Glass</b> , 7 to 8 inches long, finely finished.....	1 50
5803. Double Tube, 7 inches long, one within the other; inner one with uranium bulbs; outer one either a vacuum or filled with a fluorescent solution .....	2 25
5804. Single Tube, 10 inches long, with bulbs or spirals of uranium glass..	2 75
5805. Double Tubes, 8 to 9 inches long, with uranium glass or fluorescent solutions .....	3 50
5806. Double Tubes, 15 inches long, various patterns of uranium glass, &c..	00
5807. Double Tubes, 19 inches long, with uranium glass and fluorescent solutions, very fine.....	6 00



	PRICE
5808. <b>Double Tubes</b> , 24 inches long, with uranium spirals and bulbs. All these long tubes finished with the utmost care.....	\$7 00
5809. Same as No. 5808, but 27 inches long.....	8 00
5810. Do do 30 do .....	9 00
5811. <b>Tube</b> , about 12 inches high, containing within it a <i>Cross</i> of uranium glass; with stand .....	6 00
5812. Tube, same character as No. 5811, but containing a vase of uranium glass to show as a small <i>Gassiot's Cascade</i> .....	6 00
5813. Tube 18 inches long, with large bulbs for showing <i>stratification</i> of the electric light ..	5 00
5814. <b>Phosphorescent Tube</b> , containing in a vacuum, a phosphorescent solid, which glows for some seconds after the discharge has ceased.	2 50
5815. Same as No. 5814, but larger and finer.....	5 00
5816. <b>Crowns of Uranium Balls</b> , 7 inches high, with stand.....	4 50
5817. <b>U Tubes</b> ; double, with different fluorescent solutions in each arm. Arms 9 inches long. With stands. Each .....	5 00
5818. U Tubes, same as 5817, but arms only 7 inches long Each.....	3 00
5819. <b>Phosphorescent Tubes</b> , in which no coil is needed, but the light is evolved by the friction of mercury falling upon globes of glass within an exhausted tube. Each .....	4 50
5820. Same as 5819, but larger, and with bulbs of uranium glass in the inner tube.....	6 50
5821. <b>Induction Tubes</b> . A double tube 26 inches long, the inner of uranium glass, which becomes luminous by being held near an excited electric body, or by being itself rubbed on the outside by flannel or fur.....	6 00
Nos. 5819, 5820, and 5821, will be seen to be very curious, as they need no coil or electrical machine to excite them.	

## PLÜCKER'S OR SPECTRUM TUBES,

Having traces of the several elements mentioned below and to be used with the Induction Coil and the Spectroscope. The late solar researches render these tubes invaluable to the teacher and physicist.

5850. Oxygen.	5859. Fluoride of Silicon.	
5851. Hydrogen.	5860. Cyanogen.	
5852. Nitrogen.	5861. Chloride of Tin.	
5853. Carbonic Oxide.	5862. Ammonia.	
5854. Carbonic Acid.	5863. Vapor of water.	
5855. Iodine.	5864. Mercury.	
5856. Chlorine.	5865. Sulphur.	
5857. Bromine.	5866. Selenium.	
5858. Fluoride of Boron.	5867. Sulphuret of Mercury.	
Each.....		\$2 00

Many of these tubes give most brilliant results, also, when used as Geissler's Tubes. Nothing finer indeed can be found in this line than the tubes containing Hydrogen, Nitrogen, Iodine, Chloride of Tin, Fluoride of Boron, and Fluoride of Silicon.

## SECTION XVI.—OF THERMO-ELECTRICITY.

5900. <b>Pair of Elements</b> . Of brass and German silver.....	\$0 75
5901. <b>Thermo-Multiplier</b> . Five pairs of brass and German silver.....	5 00



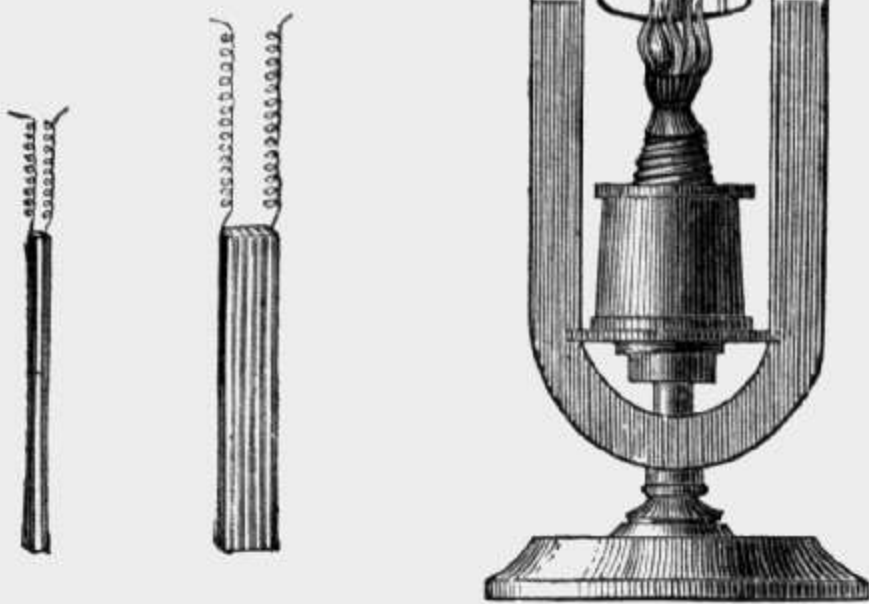

5900.

5901.

5902.

- |   | PRICE  |
|---|--------|
| 5902. <b>Thermo-Electric Arch.</b> Consists of a permanent magnet, between the poles of which is placed an arch, the ends of which are soldered to a ring, the arch and ring by a pivot are free to turn upon the support placed between the poles; a lamp upon a movable stand attached to the support can be raised or lowered, as may be required. . . . . | \$7 00 |
| 5903. <b>Thermo-Multiplier.</b> Consisting of twenty-five pairs of bismuth and antimony, mounted in neat brass case, with caps, cones, and binding-screws, on an adjusting stand. . . . .   | 30 00  |
| 5904. <b>Thermo-Multiplier.</b> Similar to No. 5903, but consisting of thirty-six pairs of bismuth and antimony. . . . .  | 45 00  |
| 5905. <b>Thermo-Multiplier.</b> Similar to No. 5903, but consisting of forty-nine pairs of bismuth and antimony. . . . .  | 60 00  |

SECTION XVII.—OF ELECTRO-MOTORS.



5915.

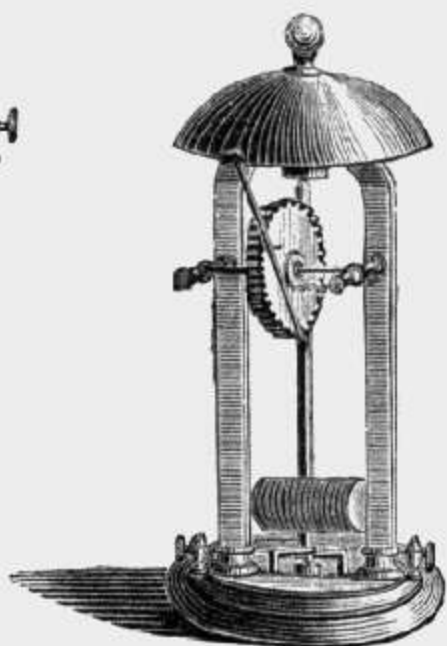

5916.

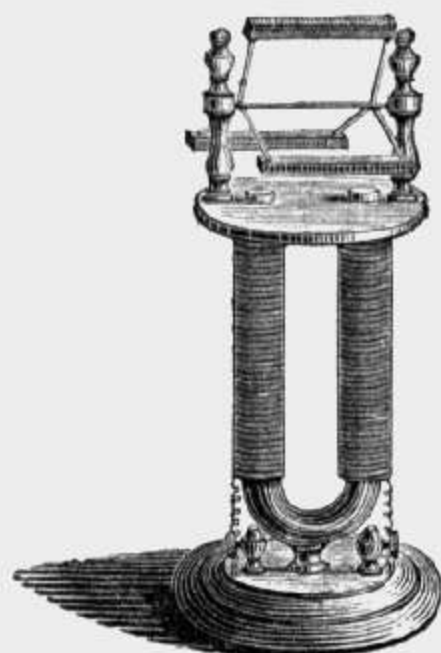

5917.

ELECTRO-MOTORS.

105

	PRICE
5915. <b>Revolving Electro-Magnet.</b> Consisting of a permanent horseshoe magnet, with an electro-magnet rotating freely upon an axis placed between its poles.....	\$8 00
5916. <b>Bell Engine.</b> Similar to No. 5915, but with the addition of a bell, which is struck by a hammer set in motion by the electro-magnet.	16 00
5917. <b>Revolving Armatures.</b> Consisting of an electro-magnet, with a wheel carrying three soft iron armatures, rotating above the poles.....	10 00

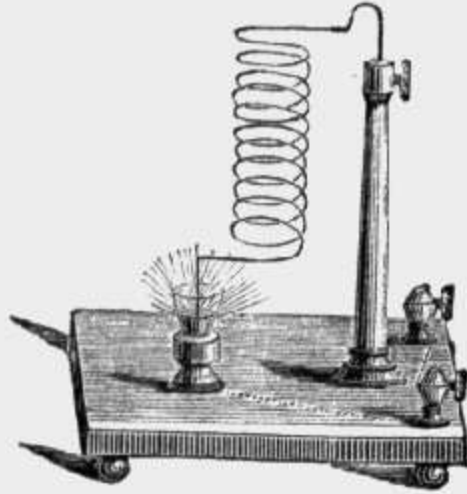

5918.

5918. <b>Contracting Helix of Copper Wire,</b> with brass pillar and mercury cup on rosewood base.....	5 50
5919. <b>Revolving Coil.</b> A copper coil connected with binding screws, rotating between the poles of a strong permanent horseshoe magnet....	8 00
5920. <b>Revolving Magnet.</b> The converse of No. 5919.....	8 00
5921. <b>Page's Reciprocating Engine.</b> .....	16 00
5922. <b>Revolving Spur-Wheel.</b> .....	12 00

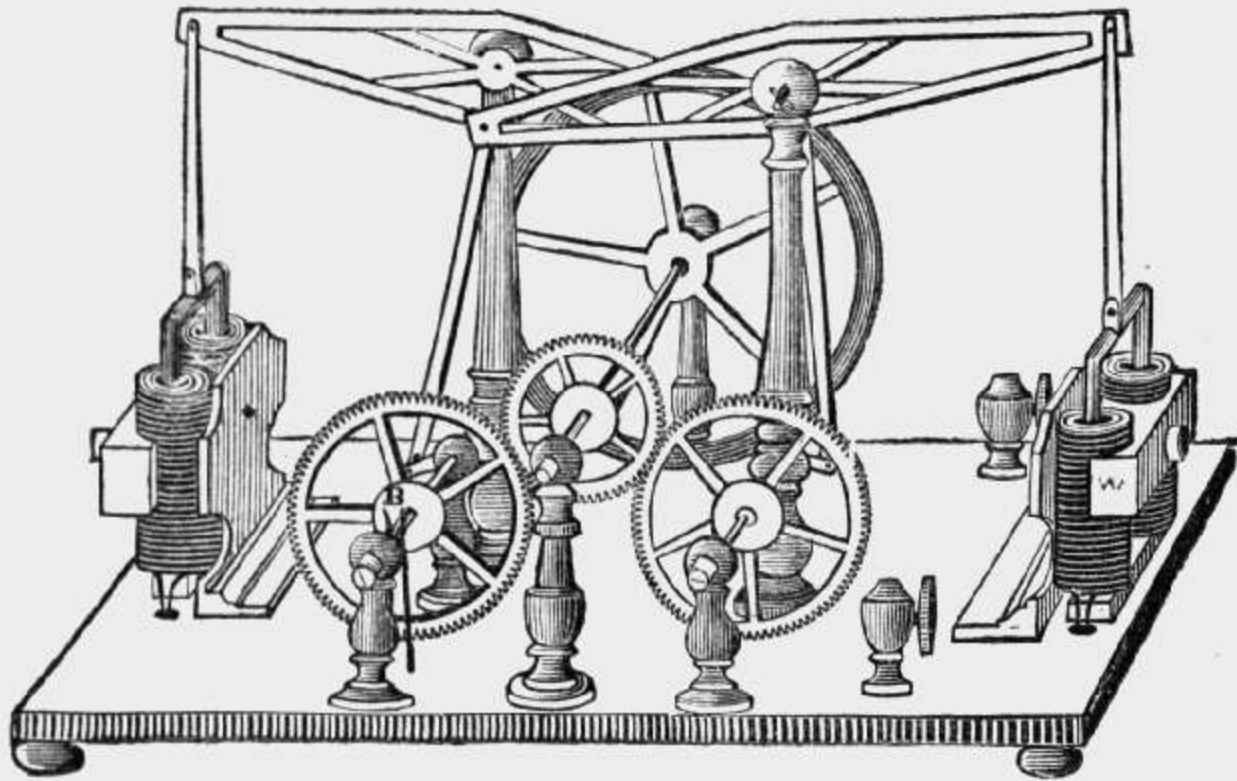

5923.

5923. <b>Double Beam Magnetic Engine.</b> .....	24 00
5924. <b>Clockwork Electrotome.</b> With copper spiral to show the intensification of the spark. Without cell. ....	15 00



## SECTION XVIII.—ACCESSORIES TO GALVANIC APPARATUS.

	PRICE
5950. Cotton-Covered Copper Wire, No. 12, per lb.....	\$1 25
5951. Cotton-Covered Copper Wire, No. 18, per lb.....	2 25
5952. Cotton-Covered Copper Wire, No. 30, per lb.....	3 00
5954. Silk-Covered Copper Wire, No. 36, per lb.....	10 00
5955. Silk-Covered Copper Wire, double coated, No. 36, per lb.....	12 50
5957. Office Wire, covered with gutta-percha, per yard.....	75
5958. Rolled Zincs, 2½ inches by 1½ inches each.....	20
5959. Rolled Zincs, 3½ inches by 1½ inches each.....	30
5960. Rolled Zincs, 3½ inches by 2 inches each.....	40
5961. Rolled Zincs, 4 inches by 2½ inches each.....	60
5962. Cast Zincs for Grove's Battery. Hollow cylinders with arm 3½ inches high by 2¼ inches in diameter, each.....	1 00
5963. Zincs for Grove's Battery. Wollaston style, 3 inches wide.....	75
5964. Platinum Strips, 3 inches long by 1 wide.....	75
5965. Platinum Strips, 6 inches long by 2½ wide.....	2 50
5967. Platinized Silver Strips, 3½ inches long by 2¼ inches wide (Smee's).....	1 00
5968. Platinized Silver Strips, 5 inches long by 4 inches wide (Smee's).....	2 50
5970. Flat Carbon Poles, for bichromate battery, 5½ inches by 1½ inches.....	1 00
5971. Flat Carbon Poles for bichromate battery, 7 inches by 1½ inches.....	1 50
5972. Flat Carbon Poles for bichromate battery, 8 inches by 2 inches.....	2 00
5975. Porous Cups, cylindrical (Grove's), 1½ inches in diameter and 3½ inches high.....	25
5976. Porous Cups, flat (Grove's), 5½ inches deep by 3 inches long and ¾ inch wide.....	50
5980. Glass Tumblers. 3½ inches in diameter and 4½ inches deep, each.....	50
5981. Glass Tumblers. 4 inches in diameter and 5 inches deep, each.....	75
5985. Rubber Cells. Flat form (Grove's), 5½ inches deep, 4 inches long, and 3 inches wide.....	2 25



5988.



5989.



5990.



5991.

5988. Binding-Screw. With two holes and clamps, and taper screw for fastening into wood, for temporary attachments. Each.....	1 00
5989. Binding-Screws, to attach two wires together.....	50
5990. Binding-Screws. With two holes and clamps, with solid base, to attach permanently to a table. Each.....	1 00
5991. Binding-Screws. With one hole and clamp and a screw with nut for fastening to base of any apparatus.....	75



## CHAPTER VIII.

## OPTICS.

## SECTION I.—ARTIFICIAL SOURCES OF LIGHT.

	PRICE
6050. <b>Calcium Light Apparatus.</b> Consisting of oxyhydrogen blow-pipe, with the necessary tubing, pressure gauges, and gas-bags.....	\$75 00
6051. Same as No. 6050, but with superior gas-bags.....	100 00
6055. <b>Electric Lamp.</b> (See No. 5580).....	22 50
6056. <b>Browning Small Electric Lamp</b> .....	30 00
6057. <b>Browning Large Electric Lamp</b> .....	95 00
6058. <b>Duboscq's Electric Regulator</b> .....	120 00
6059. <b>Foucault's Electric Regulator</b> .....	215 00
6060. <b>Battery of 50 Grove's Cells</b> , large size, for either of the above electric lamps.....	250 00
6061. <b>Queen's Improved Magnesium Lamp</b> , with clock, feeding two ribbons	50 00
6062. <b>Extension Tube</b> , for No. 6061. Fifteen feet long, to carry off the vapors of magnesia.....	
6063. <b>Extension Bag.</b> To receive the fumes of magnesia, when the tube No. 6062 cannot be used.	

## SECTION II.—OF PHOTOMETERS.

6075. <b>Ritchie's Photometer.</b> Small model.....	15 00
6076. <b>Rumford's Photometer.</b> Small model.....	12 00
6078. <b>Wheatstone's Photometer.</b> Small model.....	18 00

## SECTION III.—INSTRUMENTS ILLUSTRATING REFLECTION.

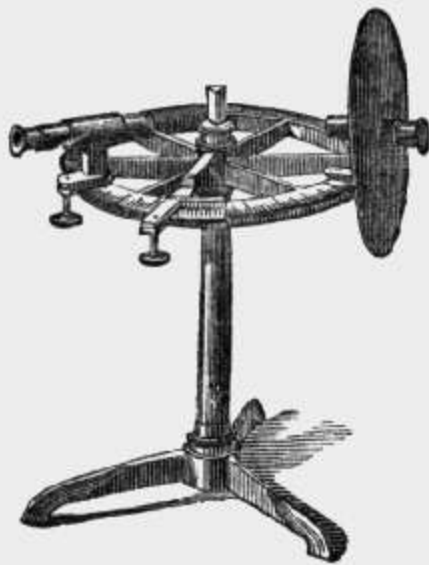

6090 and 6142.

6090. <b>Vertical Circle</b> of brass, sixteen inches in diameter, graduated to the fourth of a degree, and reading by verniers to minutes, with a plane mirror at centre, a telescope attached to one vernier, and a collimator to the other. For exact experiments on the laws of reflection and refraction, and as a goniometer. Mounted upon a firm support of metal, with a joint which enables the circle to be placed in the horizontal position when desired, as in experiments on refraction and dispersion.....	100 00
---	--------

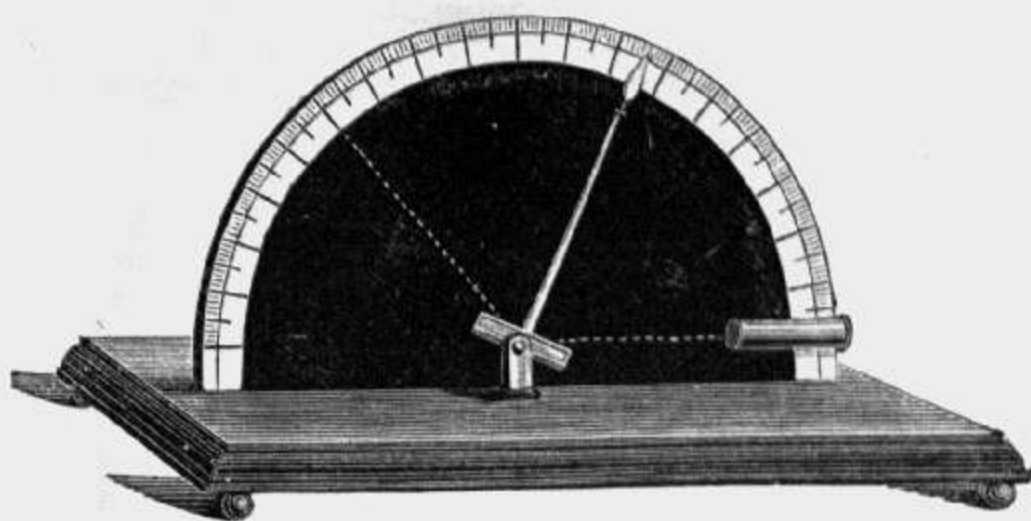

6091.



6093 and 6094.

	PRICE
6091. <b>Vertical Semicircle.</b> Thirty-six inches in diameter, graduated to degrees, with background of black velvet. A mirror at the centre is furnished with an index set exactly perpendicular to its plane, and both mirror and index can be turned in any direction desired. A ray of light from any brilliant source is allowed to enter the collimator at the base, in the direction of the centre, and by means of a little smoke from brown paper, the paths of the incident and reflected rays, as well as the relation of the latter to the plane and movement of the mirror, are easily shown to a large audience.....	\$30 00
6092. <b>Apparatus to show Plane and Diffused Reflection.</b> Consisting of a mirror polished on the one side and left unburnished on the other. Mounted upon an adjusting stand.....	7 50
6093. <b>Plane Mirror.</b> An elliptical plate-glass mirror, mounted on an adjustable frame of mahogany, ten inches long by eight inches wide..	5 00
6095. <b>Magic Telescope</b> .....	10 00

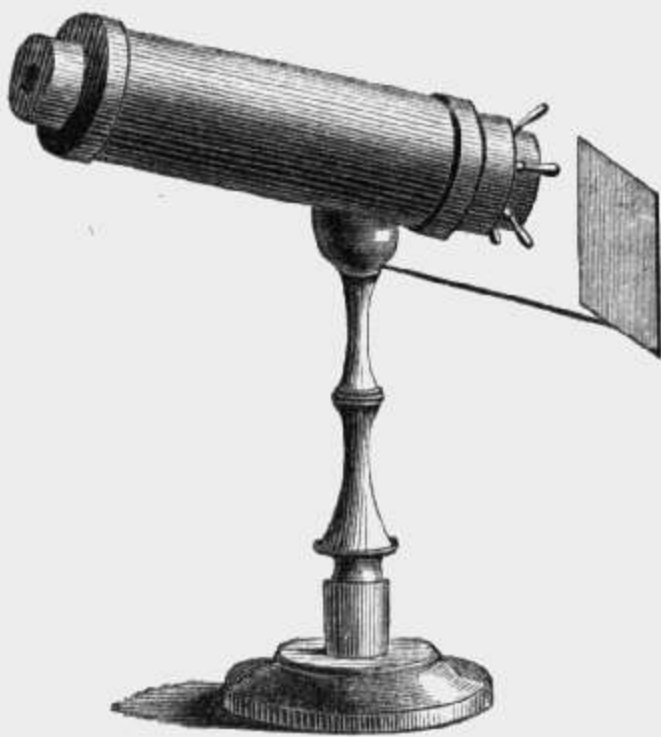

6097.

6097. <b>Kaleidoscope.</b> On stand of walnut, with brass fittings.....	3 50
6098. <b>Kaleidoscope for Projection,</b> mounted in brass, with lens; complete	20 00
6099. <b>Silvered Brass Band to show Caustics by Reflection,</b> and also the line followed by a beam of light undergoing successive reflections from its surface.....	10 00

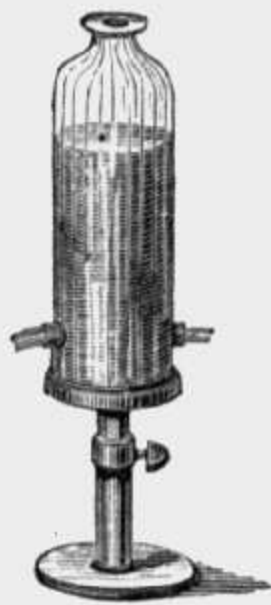

6100.

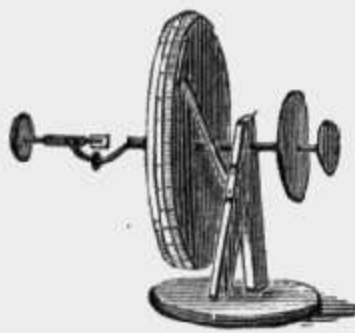

6102.



6103.

	PRICE
6100. <b>Illuminated Fountain.</b> Illustrating the total reflection of light in a liquid vein. Consisting of a glass vessel fourteen inches high, with a glass valve, and an aperture for smooth vein on one side and a condensing lens on the other.....	\$12 50
6101. <b>Illuminated Fountain.</b> Similar to No. 6100, but much larger and made of heavy tin, neatly japanned, with apertures of two different sizes for the flow of the water.....	20 00
6102. <b>Wollaston's Goniometer.</b> Small working model.....	30 00
6103. <b>Porte Lumière.</b> A mirror with a rotary and an inclination movement, to be adjusted by hand, for reflecting the rays of the sun into a room. Small model of brass.....	35 00
6104. <b>Porte Lumière.</b> Large model, with two mirrors; one of silvered plate-glass, the other of polished black-glass. Movements very perfect..	85 00

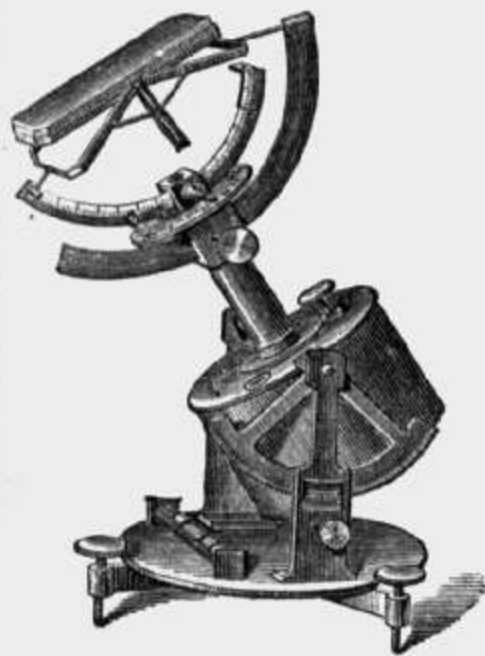

6110.

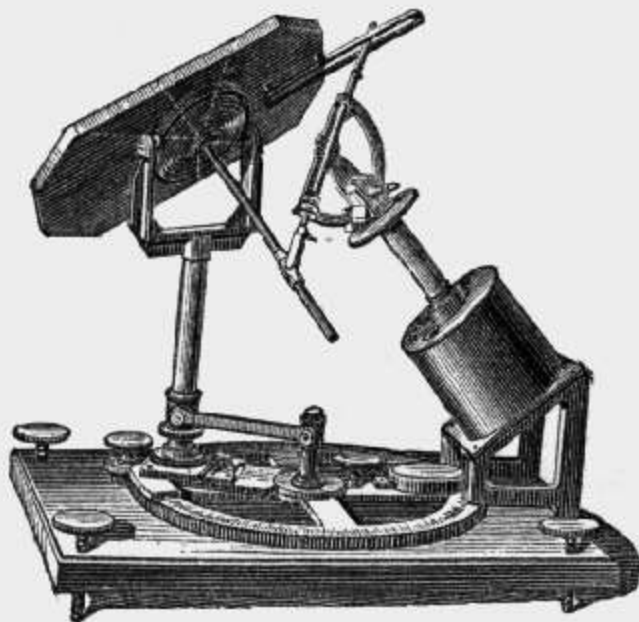

6111.

6110. <b>Silbermann's Heliostat.</b> For the purpose of keeping the rays of the sun always reflected in the same direction, by means of clockwork.	250 00
6111. <b>Foucault's Heliostat.</b> For the same purpose.....	400 00





6114 and 6115.

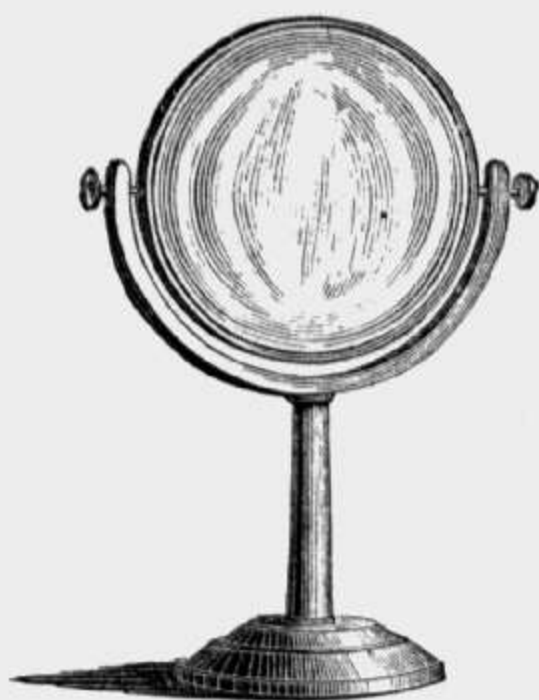

6116-6118.

	PRICE
6114. <b>Spherical Concave Mirror of Silvered Glass.</b> Six inches in diameter, mounted in frame to suspend.....	\$2 50
6115. <b>Spherical Concave and Convex Mirrors.</b> Of silvered glass, six inches in diameter, in same frame, to suspend.....	3 00
6116. <b>Spherical Concave Mirror.</b> Of silvered glass, six inches in diameter, accurately ground and polished, mounted in a brass ring, and suspended, with free movement in all directions, on a neat brass stand.....	27 50
6117. <b>Spherical Convex Mirror.</b> Of silvered glass, six inches in diameter, accurately ground and polished, mounted in a brass ring, and suspended, with free movement in all directions, on a neat brass stand.....	27 50
6118. <b>Spherical Concave and Convex Mirrors.</b> Nos. 6116 and 6117, mounted in the same way as these numbers, but both on one stand.....	40 00
6119. <b>Spherical Concave and Convex Mirrors.</b> Same as No. 6118, but silvered upon the <i>front surface</i> of the glass.....	40 00
6120. <b>Cylindrical Mirror.</b> Of glass, six inches in diameter, to show caustics and aberration by reflection, in black frame, to suspend.....	2 50
6121. <b>Cylindrical Mirror of Glass.</b> Of fine plate-glass, silvered, twelve inches high by nine inches wide, in neat walnut frame.....	15 00
6123. <b>Anamorphoscope, or Cylindrical Mirror.</b> With distorted figures, which become perfect on being looked at in the mirror.....	2 50
6124. <b>Conical Mirror.</b> With similar forms and for a similar purpose.....	10 00
6126. <b>Claude Lorraine, or Black Convex Mirror.</b> Five and a quarter inches by six and a quarter, in neat morocco case.....	6 25
6127. <b>Claude Lorraine Mirror,</b> as No. 6126, but seven and a half inches by nine and a half.....	12 50
6130. <b>Pair of Parabolic Reflectors.</b> Of copper, nickel-plated, thirteen inches in diameter, mounted on neat adjusting stands of mahogany, with brass fittings.....	50 00
6131. <b>Pair of Parabolic Reflectors.</b> Of copper, nickel-plated, twenty inches in diameter, mounted on neat adjusting stands of mahogany, with brass fittings.....	75 00

## SECTION IV.—OF REFRACTION.

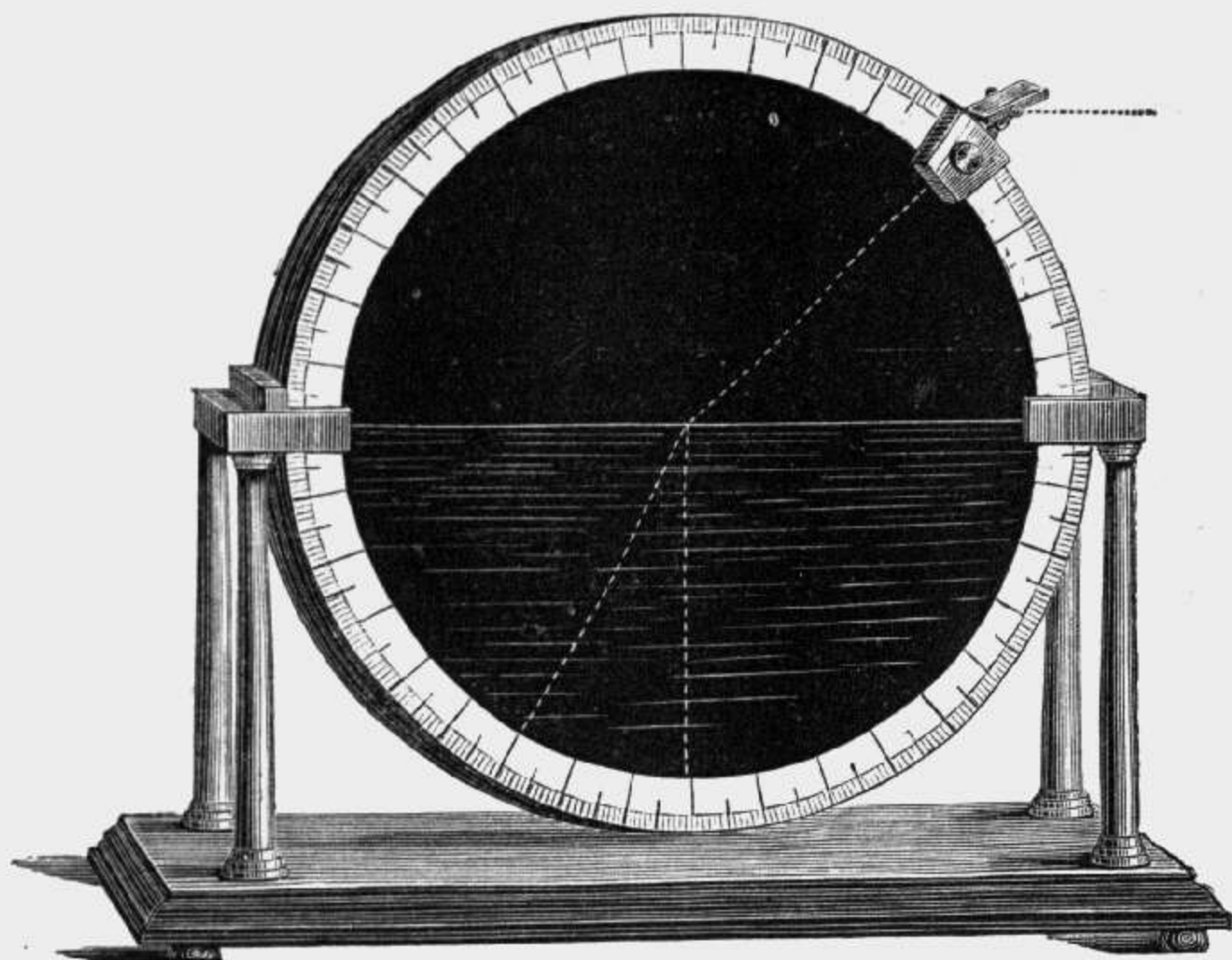

6141.

- |   | PRICE   |
|---|---------|
| 6140. <b>Refraction Model.</b> To show the constancy of the proportion of the sines in all angles of incidence and refraction, consisting of a strong disc of card-board two feet in diameter, mounted upon a neat polished mahogany frame, and having two arms radiating from the centre, which represent the incident and refracted rays. A mechanism at the back moves these arms in exact accordance with the law of the sines, showing the conformity to the law at all angles. Relation of the sines is that of 1:1.5.....  | \$25 00 |
| 6141. <b>Refraction Apparatus.</b> Class Model, consisting of a circular tank, eighteen inches in diameter, with plate-glass sides and solid glass connections, fastened securely on a strong brass frame, graduated on its circumference, and furnished with a mirror which can be moved to any point in the circumference, and which reflects a ray of light from the oxyhydrogen or electric lamp directly to the centre of the circle. As the tank is filled to the centre with water, it is clear that all the essential principles of <i>refraction</i> , as well as <i>total reflection</i> , are readily shown..... | 50 00   |
| 6142. <b>Apparatus for the Accurate Measurement of the Refractive Indices of Bodies.</b> For complete description, see No. 6090.....  | 100 00  |





6145.

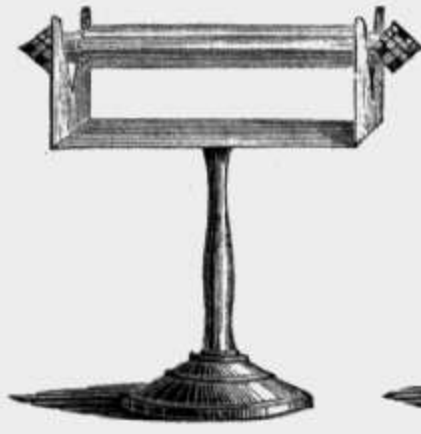

6146-6149

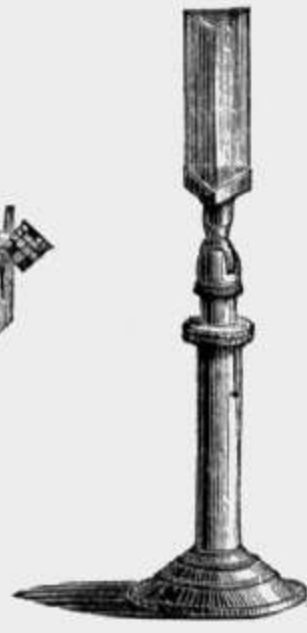

6151.



6160-6162

	PRICE
6145. <b>Hollow Prism of Glass</b> , eight inches long, with compartments to be filled with various liquids, to demonstrate their different refractive as well as dispersive powers; on elevating stand of brass, finely finished.....	\$20 00
6146. <b>Prism of Flint Glass</b> , five inches long from end to end, mounted on a neat stand.....	3 50
6147. Prism of Flint Glass, on stand, same as No. 6146, but six inches long.	3 75
6148. Prism of Flint Glass, on stand, seven inches long.....	4 00
6149. Prism of Flint Glass, on stand, eight inches long.....	4 50
6150. <b>Fine Prism</b> , accurately ground and polished. One to one and a quarter inches on a side, about three inches long, square ends. ....	5 00
6151. Fine Prism. Same as No. 6150, but mounted with a ball and socket-joint, on neat polished brass stand.....	10 00
6154. <b>Fine Rectangular Prism</b> . One and a quarter inches on a side, accurately ground and polished.....	5 00
6155. Fine Rectangular Prism of Flint Glass, over two inches and a quarter on the side, for inversion and total reflection in projection .....	25 00
6157. <b>Fine Conical Prism</b> . Giving circular spectrum.....	7 50

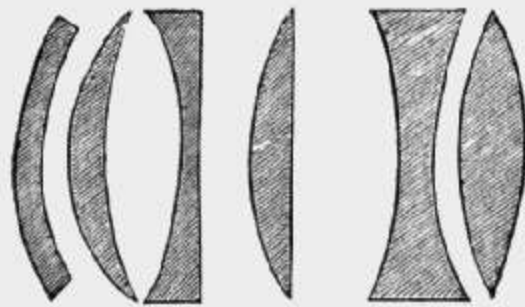

6158 and 6159.

6158. <b>Demonstration Lenses</b> . Set of six, one and seven-eighths inches in diameter.....	2 50
6159. <b>Demonstration Lenses</b> . Set of six, two and a quarter inches in diameter, very superior.....	7 50
6160. <b>Lens of Crown-glass</b> . Four and a half inches in diameter, on brass stand.....	7 50
6161. Lens similar to No. 6160, and in similar mounting, but six inches in diameter.....	9 00
6162. Lens similar to No. 6160, and in similar mounting, but eight inches in diameter.....	12 00



## SECTION V.—OF DISPERSION.

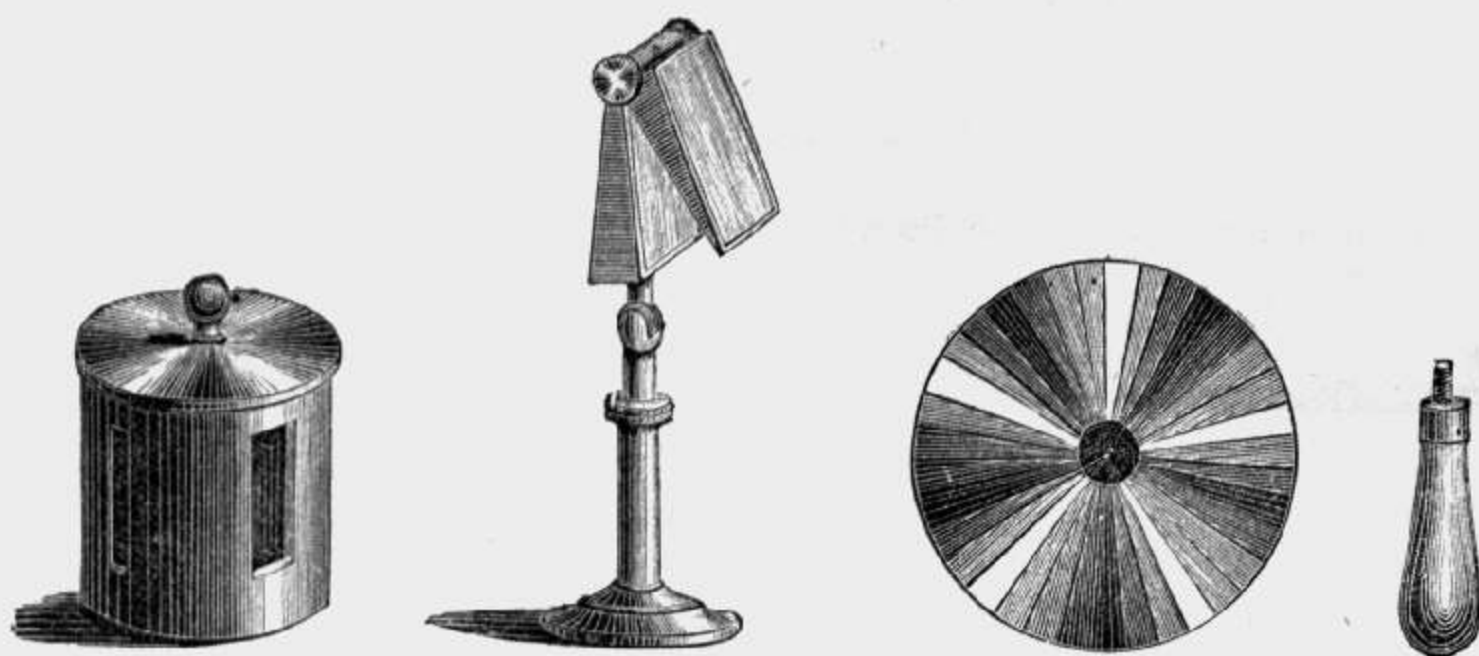

6180.

6182.

6190.

	PRICE
6175. <b>Flint Glass Prism.</b> One inch on side, very pure and of high refractive power, perfectly polished, angle of sixty degrees, for use in spectroscope.....	\$12 00
6176. <b>Flint Glass Prism.</b> One and a quarter inches on a side, similar to No. 6175, but polished on two sides only.....	10 00
6177. <b>Hollow Prism for Bisulphide of Carbon.</b> Bottle form, three inches high.....	5 00
6178. <b>Hollow Prism for Bisulphide of Carbon.</b> Bottle form, six inches high.....	7 50
6179. <b>Hollow Prism for Bisulphide of Carbon.</b> Globular or Spirit-Lamp form, three inches in diameter.....	5 00
6180. <b>Brass Box with two Hollow Prisms,</b> No. 6177, arranged at the angle of minimum deviation.....	22 50
6181. <b>Brass Box with two Hollow Prisms,</b> No. 6178, arranged at the angle of minimum deviation.....	30 00
6182. <b>Achromatic Prism.</b> On brass stand, with joint to incline to any angle.....	10 00
6185. <b>Achromatic Lens.</b> One and seven-eighths inches in diameter and ten inches focus, unmounted.....	5 00
6186. <b>Achromatic Lens.</b> Same as No. 6185, but mounted on an adjustable brass stand.....	10 00
6187. <b>Achromatic Lens.</b> Three inches in diameter and twelve inches focus, unmounted.....	20 00
6188. <b>Achromatic Lens.</b> Same as No. 6187, but mounted on an adjustable brass stand.....	27 50
6190. <b>Newton's Disc.</b> For the recomposition of white light. A card-board disc, twelve inches in diameter, with the colors of the spectrum as rays from the centre. A brass bearing at the centre permits the whole to be supported upon a metal pin, and revolved rapidly by a cord and drum.....	5 00
6191. <b>Newton's Disc.</b> Similar to No. 6190, but thirty inches in diameter, and intended to be used upon a vertical whirling-table, such as No. 6639.....	5 00
6192. <b>Brewster's Disc.</b> Similar to 6191, but having the <i>three primary</i> colors instead of the whole seven of the spectrum.....	3 50
6193. <b>Newton's &amp; Brewster's Discs.</b> Nos. 6191 and 6192 on opposite sides of the same card-circles.....	7 00

## SECTION VI.—SPECTRUM ANALYSIS.

	PRICE
6200. <b>Direct Vision Pocket Spectroscope.</b> Three and one-half inches long, and five-eighths of an inch in diameter. Consists of a series of five prisms, on the principle of Amici, mounted in a brass tube, with an adjustable slit.....	\$15 00
6201 Direct Vision Pocket Spectroscope. Browning's, three inches long, and seven-tenths of an inch in diameter, with five prisms and adjustable slit .....	18 00
6202. Direct Vision Pocket Spectroscope. Browning's, same as No. 6201, but with achromatic lenses and neat morocco case.....	25 00

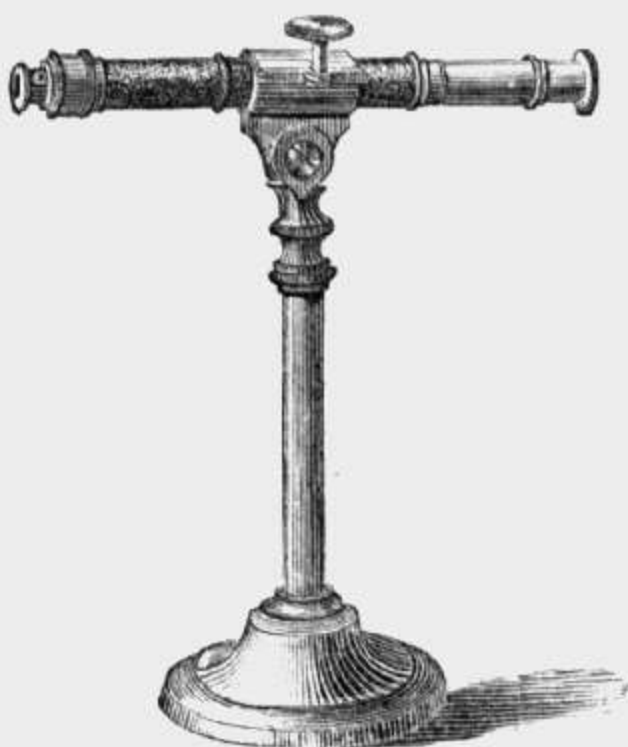

6206.

6203. <b>Direct Vision Spectroscope.</b> Large model, eighteen inches long, with five prisms, adjustable slit, and neat polished mahogany case. A powerful instrument, easily dividing the D. line.	90 00
6204. Direct Vision Spectroscope. Same as No. 6203, but on neat stand, with horizontal movements.....	100 00
6205. Direct Vision Spectroscope. Twelve inches long, and seven-eighths inch in diameter, containing five prisms, with eye-piece, adjustable to different portions of the spectrum in succession. In neat morocco case.....	37 50
6206. Direct Vision Spectroscope. Same as No. 6205, but mounted on neat stand, with horizontal movement.....	42 50
6207. Direct Vision Spectroscope. Twenty inches long, and one and a quarter inches in diameter, containing five prisms, with micrometer for measuring the position of the lines, and screw movement to eye-piece, to adjust the lenses to different portions of the spectrum. A reflecting prism placed over a portion of the slit permits two spectra to be compared.....	125 00
6208. <b>Bunsen's Laboratory Spectroscope.</b> With one prism. Consists of a collimator, with adjustable slit and a prism for comparison of spectra, a second collimator, with a photographed millimeter scale, and a telescope for examining the rays from the former two. The prism, which is of flint-glass, is inclosed in a strong metal box. All mounted upon a neat stand and packed in a strong box with lock..	62 50
6209. Bunsen's Laboratory Spectroscope. Same as No. 6208, but with the addition of a pair of Bunsen burners, a pair of supports for the platinum loops, to hold the material for examination, a box of platinum loops in glass tubes, a set of scales for mapping spectra, and a colored chart of the spectra of the prominent alkalies and metals, compared with the solar spectrum. The instrument, but not the accessories, packed in a neat mahogany box with lock.....	75 00



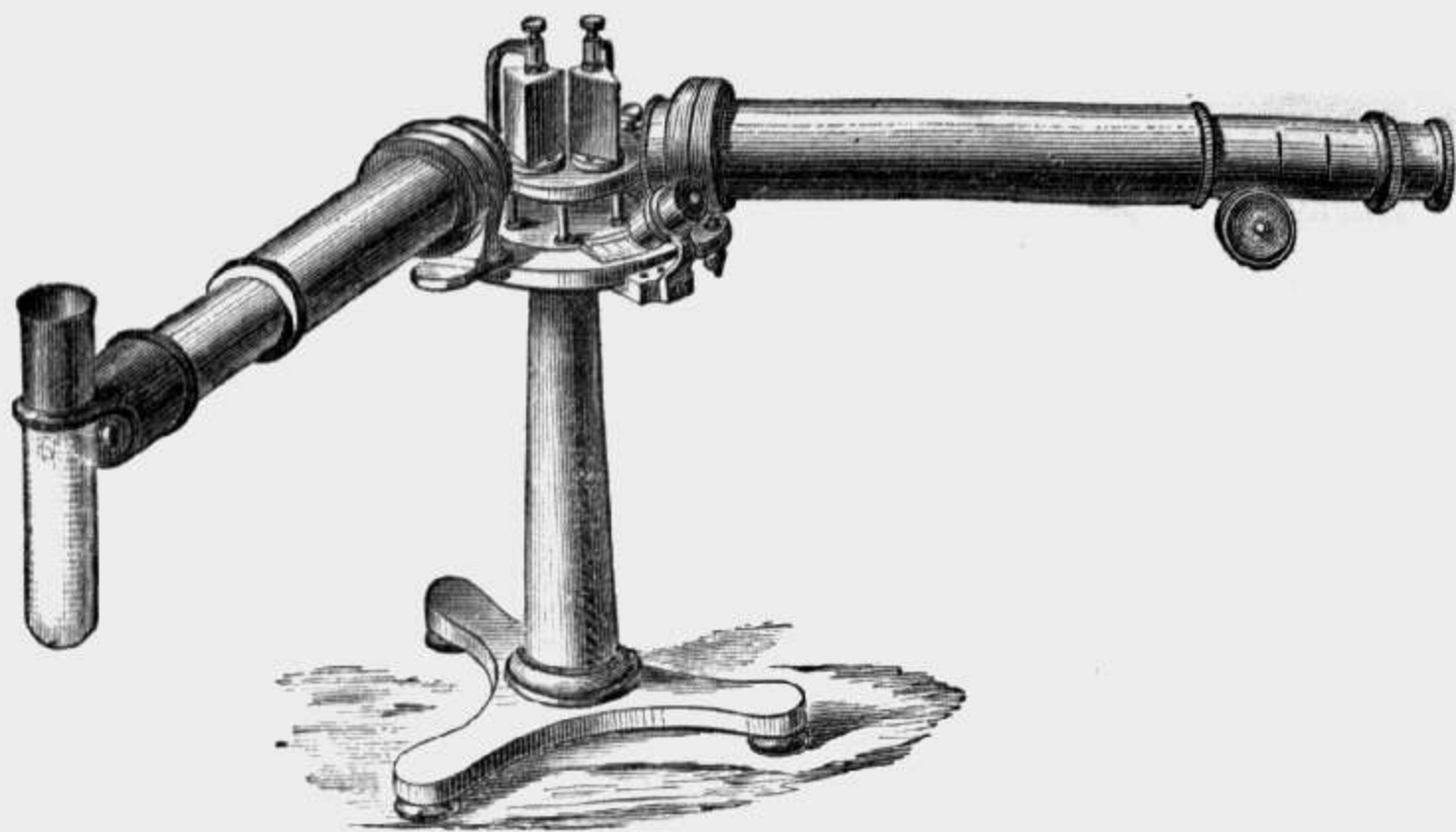

6211.

	PRICE
6210. <b>Browning's Laboratory Spectroscope.</b> With one prism of extra dense glass, two telescopes (one a collimator, carrying a slit and prism for comparison, the other for observing the spectrum). A graduated circle and vernier for measuring the position of the lines in the spectrum. In neat case.....	\$75 00
6211. <b>Model Spectroscope.</b> With two prisms of extra dense glass. Two telescopes, graduated circle, vernier, and microscope for reading the divisions. In polished mahogany case.....	160 00
6212. <b>Model Spectroscope.</b> As No. 6211, but with four prisms instead of two, with micrometer movement to measure accurately the distance between any lines of the spectrum, with fittings and two eye-pieces. In polished mahogany case.....	250 00
6213. <b>Millimeter Scales.</b> For mapping spectra. Each.....	20



6230.



6231.

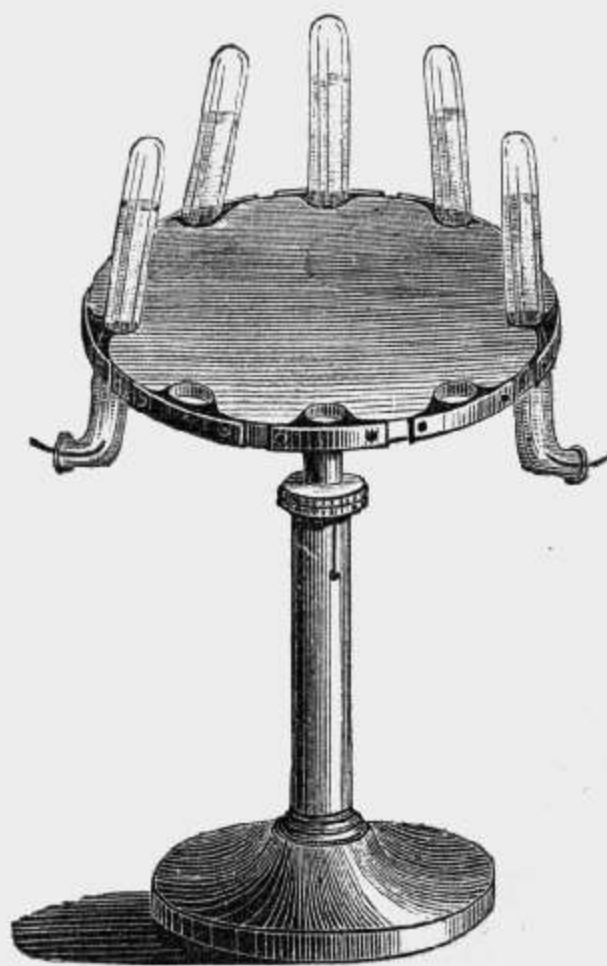

6232.

	PRICE
6230. <b>Mitscherlich's Tubes.</b> Consisting of a glass tube, with a wick of platinum wire to give a continuous supply of material for the Bunsen burner See cut, p. 115.....	\$0 50
6231. Mitscherlich Tube, with stopper .....	75
6232. <b>Stand with eight Mitscherlich's Tubes.</b> Arranged for convenient use. Consisting of a polished brass stand and pedestal, supporting a table with openings for eight tubes. The table turns horizontally, allowing any desired tube to be brought into position. See cut .....	12 00

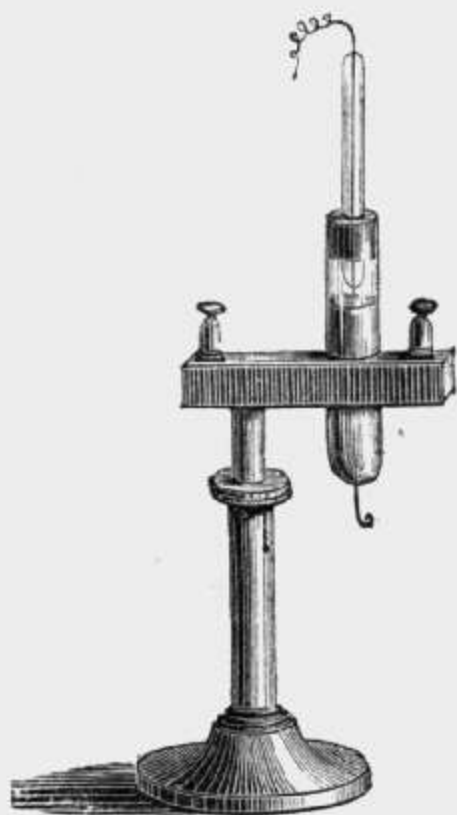

6233.

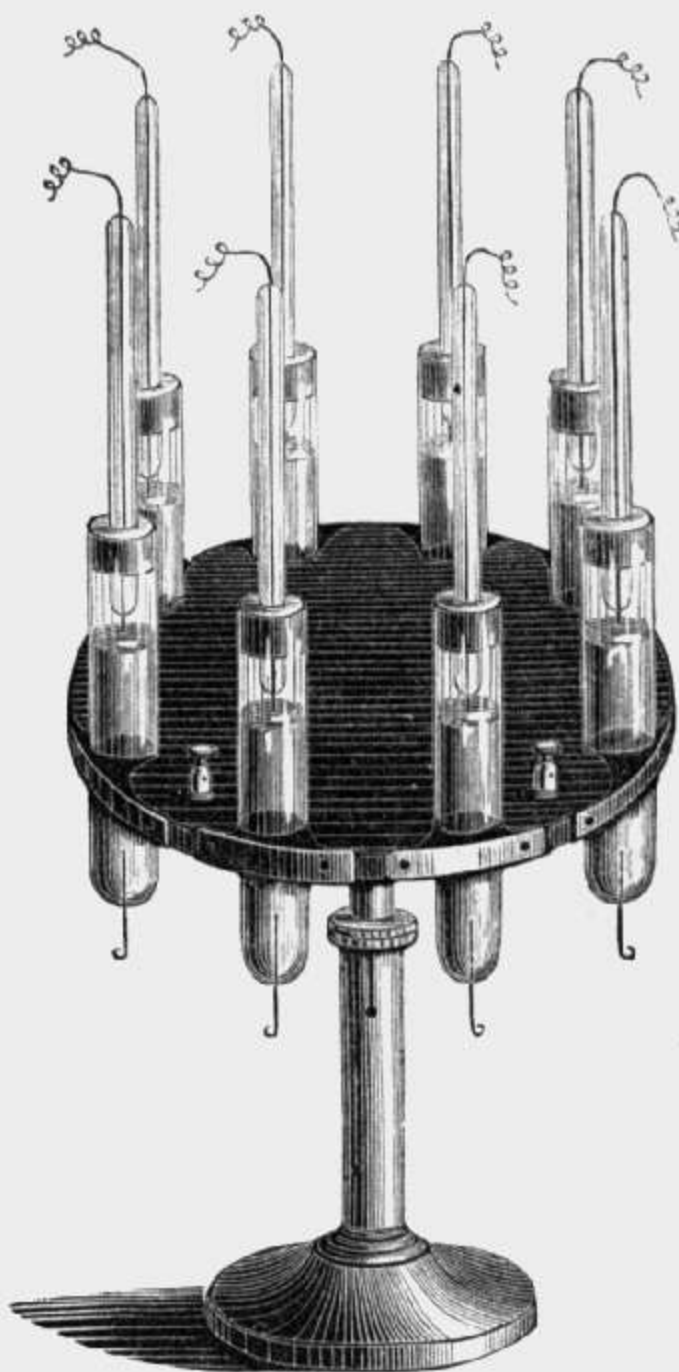

6234.

6233. <b>Becquerel's Apparatus.</b> For obtaining the spectra of liquids. Single tube on neat stand, with binding-screws.....	7 50
6234. <b>Becquerel's Apparatus.</b> Set of eight tubes, as in No. 6233, mounted in a hard-rubber platform, on a polished brass stand, with binding-screws.....	50 00



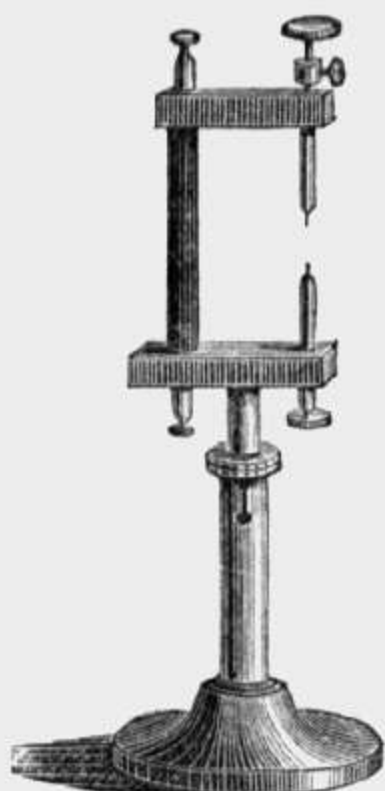

6238.

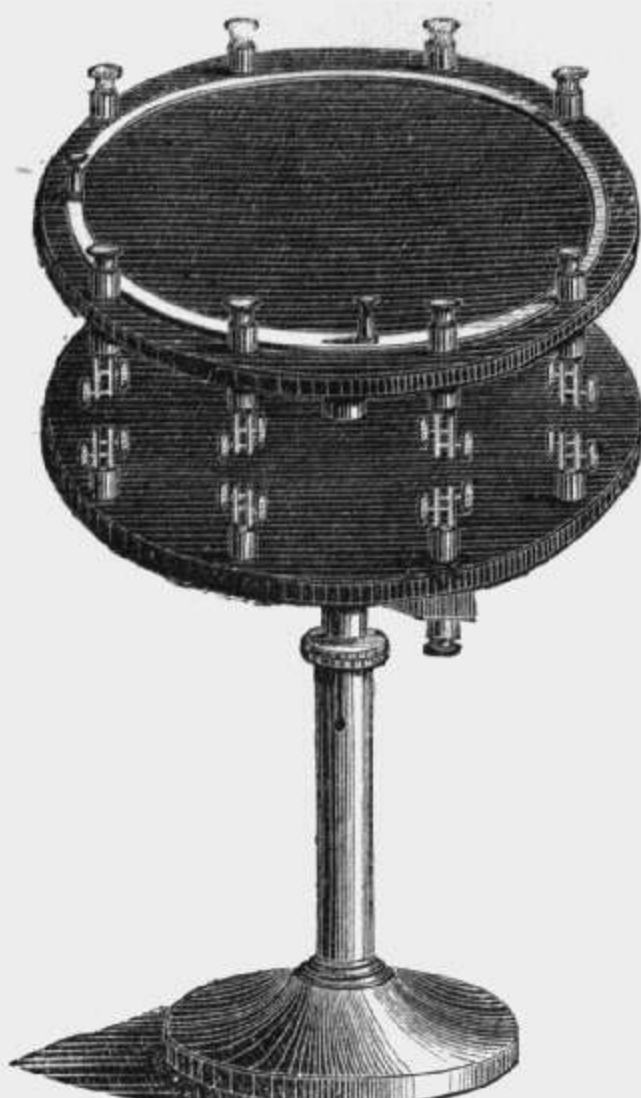

6239.

	PRICE
6238. <b>Metal Holder.</b> A pair of forceps, with clamps, in a neat brass frame, insulated by hard rubber, and mounted on an adjustable brass stand.....	\$12 50
6239. <b>Metal Holder.</b> For eight metals. A pair of hard-rubber plates, with eight pairs of forceps, with attachments to permit the passage of the current through one pair only at a time. This instrument, by which any known metal can be at once brought into comparison with the specimen under examination, and the coincidences, if any, noted at once, without the trouble of <i>mapping</i> the spectrum, has a degree of utility not easily overestimated.....	50 00
Instruments with any number of holders furnished. Each additional holder.....	4 00

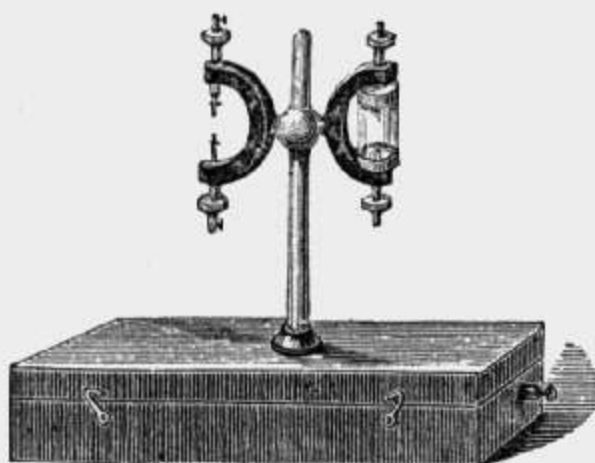

6241.

6240. <b>Spark Condenser.</b> For intensifying the spark of the induction coil, in order to volatilize the more refractory metals. Series of ten plates of glass arranged as a cascade battery, and mounted in neat wooden box .....	12 50
6241. <b>Improved Spark Condenser.</b> Packed in neat polished mahogany case, with holders for metals, etc. Very compact form.....	25 00

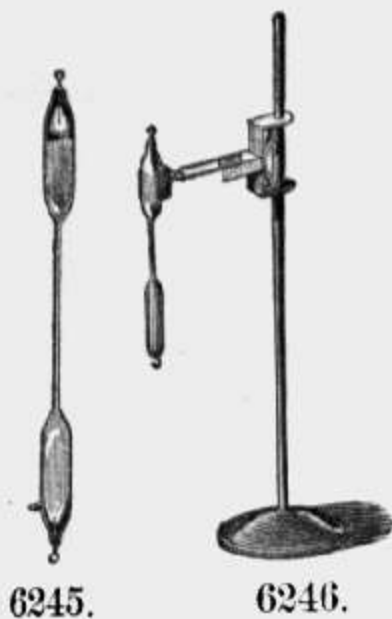

	PRICE
6245. <b>Plücker's Tubes.</b> For obtaining the spectra of gases, each.....	\$2 00
For list, see page 103, Nos. 5850 to 5867.	
6246. <b>Stand.</b> For single Plucker's tube, without tube.....	2 00
6248. <b>Set of Eight Plucker's Tubes.</b> With brass mountings, so as to permit the charge from the induction coil to pass through any one desired, in neat box with key. A very safe and convenient arrangement. . .	27 50
6249. <b>Stand with Eighteen Plucker's Tubes.</b> A cylinder covered with black velvet, with the tubes arranged around it vertically and equidistant from each other, and having connections so adjusted as to permit any desired tube to be lighted by turning the cylinder, which, for this purpose, rotates upon a vertical axis. Base and top of mahogany, with binding-screws.....	75 00

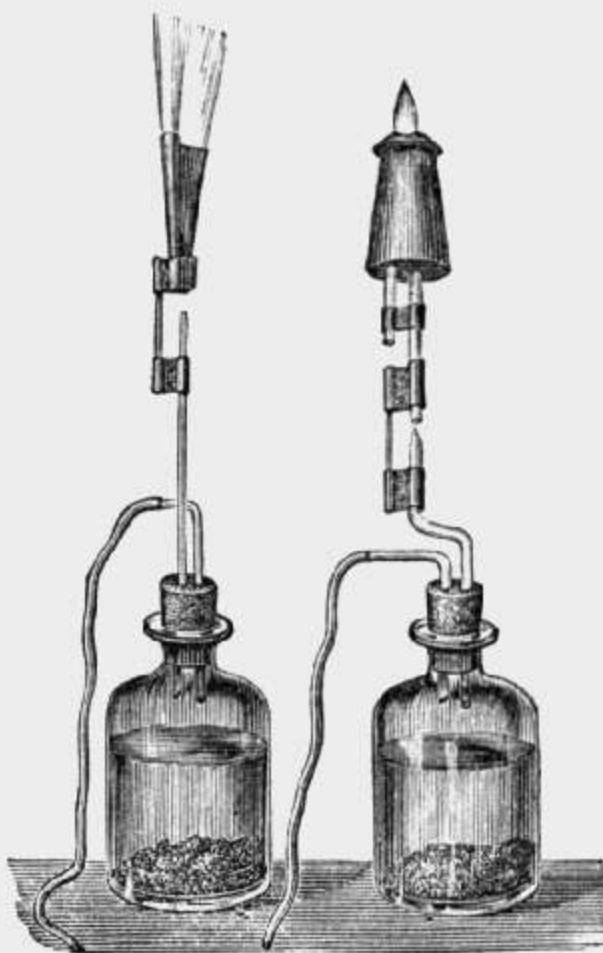

6250.

6250. <b>Bunsen's Apparatus,</b> to show the <i>reversal</i> of the sodium light.....	7 50
---	------





6276.

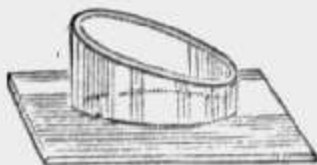

6277



6278.

- |  | PRICE  |
|--|--------|
| 6275. <b>Sorby Micro-spectroscope.</b> To be used as an eye-piece for the microscope, for determining the spectra of minute bodies, and of solutions. Packed in a neat case..... |        |
| 6276. <b>Sorby Micro-spectroscope.</b> Similar to No. 6275, but with rack motion to eye-piece, and with bright point micrometer.....   |        |
| 6277. <b>Wedge Cells,</b> for examining different thicknesses of a solution. Each.   | \$0 50 |
| 6278. <b>Small Tubes,</b> to hold solutions. Per doz.....  | 1 25   |
| 6279. <b>Specimens in Sealed Tubes,</b> for showing the absorption bands. Each.  | 50     |
- List of specimens sent on application.

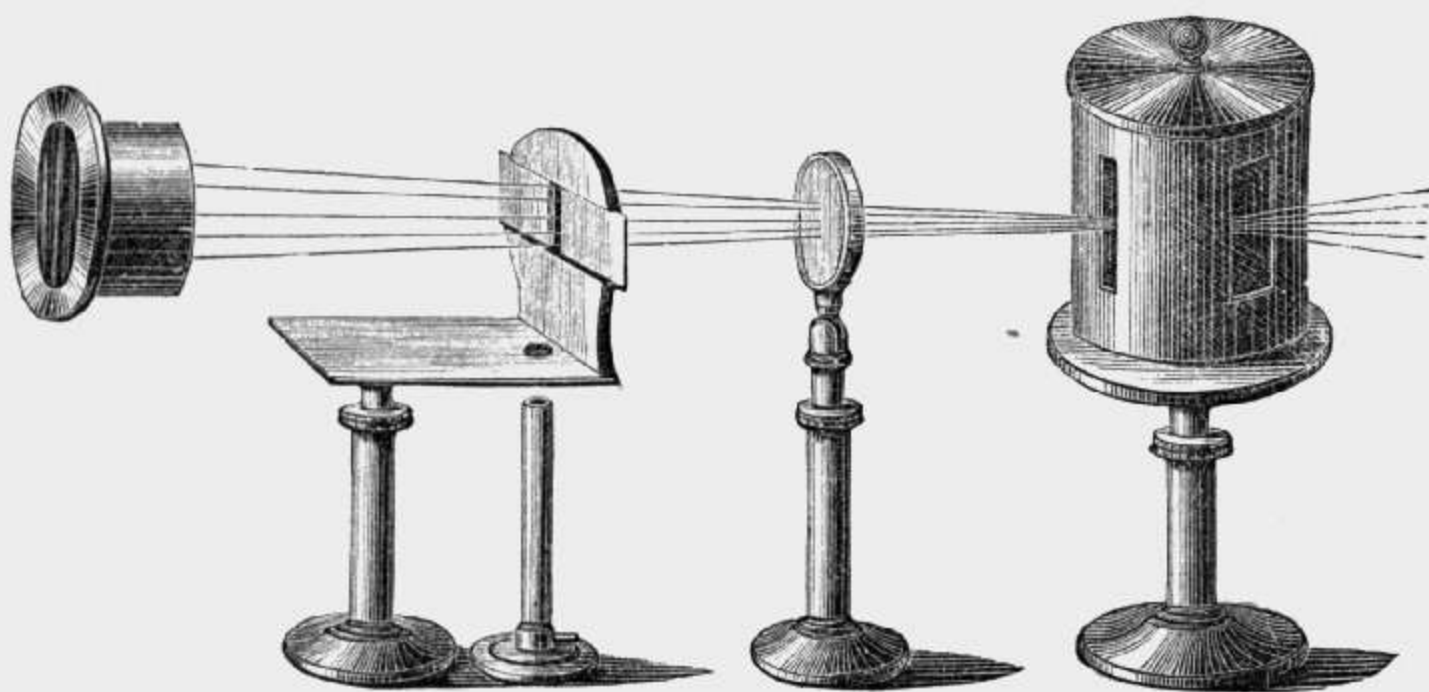

6291.

- |  |       |
|--|-------|
| 6290. <b>Spectroscope for Projection.</b> Consisting of a brass stand carrying a slit, and of a pair of hollow prisms for bisulphide of carbon, in polished brass case on stand. Can be added to any lantern by using the condensers and the magnifiers of the lantern.....  | 50 00 |
| 6291. <b>Spectroscope for Projection.</b> Consisting of a pair of condensers, four and a half inches in diameter, in brass cell, a brass stand with adjustable slit, achromatic magnifying lens, two inches in diameter, on brass stand, and a pair of hollow prisms for bisulphide of carbon, mounted in a polished brass case on adjustable brass stand. This instrument is furnished with a strong flange, by which the condensers, with magnifier, can be attached to the front of any lantern of ordinary construction..... | 85 00 |

6293. **Set of Materials in Sealed Bottles**, prepared expressly to be used with the hydro-oxygen blow-pipe, to obtain the spectra for projection. Consisting of sodium, strontium, calcium, lithium, and rubidium; per set.....

\$3 00

REMARK.—*By the aid of these preparations the spectra of these substances can be as satisfactorily demonstrated by the oxy-hydrogen blow-pipe to audiences not exceeding 1000 persons, as they can be by means of the more cumbrous electric lamp.*

All the above spectroscopes for projection are accompanied by minute printed instructions for their use.

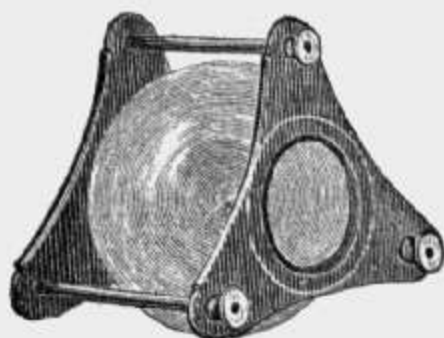

6300.

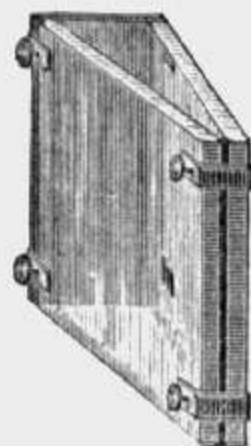

6301.

6300. **Hollow Globe**, with plate glass ends and clamps of brass, to contain iodine, bromine, hypo-nitrous acid, etc., for absorption spectra, each.....
6301. **Wedge-shaped Cell**, for liquids, to show absorption spectra.....
6302. **Cells with parallel sides**, for liquids, to show absorption spectra....
6303. **Colored Glasses** for absorption. Set of seven. Each 4 inches by 3 $\frac{1}{4}$ .

10 00

7 50

3 50

1 50

SECTION VII.—ON THE TRANSFORMATION OF VIBRATIONS.

1. PHOSPHORESCENCE.

6310. **Phosphorescent Tubes**, containing sulphurets of the alkaline earths. Set of four colors, in neat mahogany frame.....
6311. **Phosphorescent Tubes**. Same as No. 6310, but with seven tubes, giving the various tints of the spectrum.....

5 00

10 00

Nos. 6310 and 6311 are excited by placing them for a few moments in the direct rays of the sun, and then removing them quickly to a dark room.

6312.

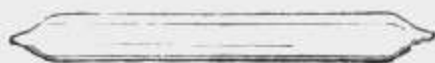

6313.

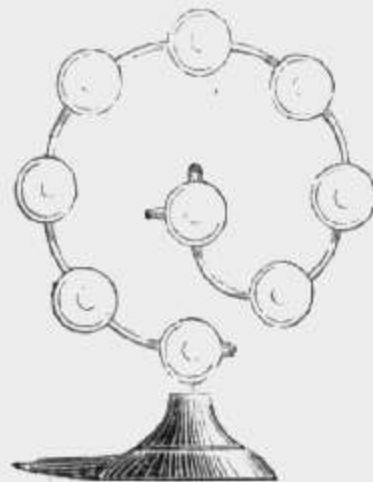

6314-15.

6312. **Phosphorescent Geissler Tubes**. Straight tubes, seven inches long, containing quantities of the sulphurets of barium, calcium, strontium, etc., each.....

2 50



	PRICE
6313. Phosphorescent Geissler Tube, curved as in Fig. 6313.....	\$8 00
6314. Phosphorescent Geissler Tube, crown-shaped, 8 inches in diameter...	5 00
6315. Phosphorescent Geissler Tube, crown-shaped, 12 inches in diameter..	7 50
6316. Phosphorescent Geissler Tube, double-crown, 15 inches in diameter..	20 00

These tubes have the great advantage that they can be used at any time of day or night.

2. FLUORESCENCE.

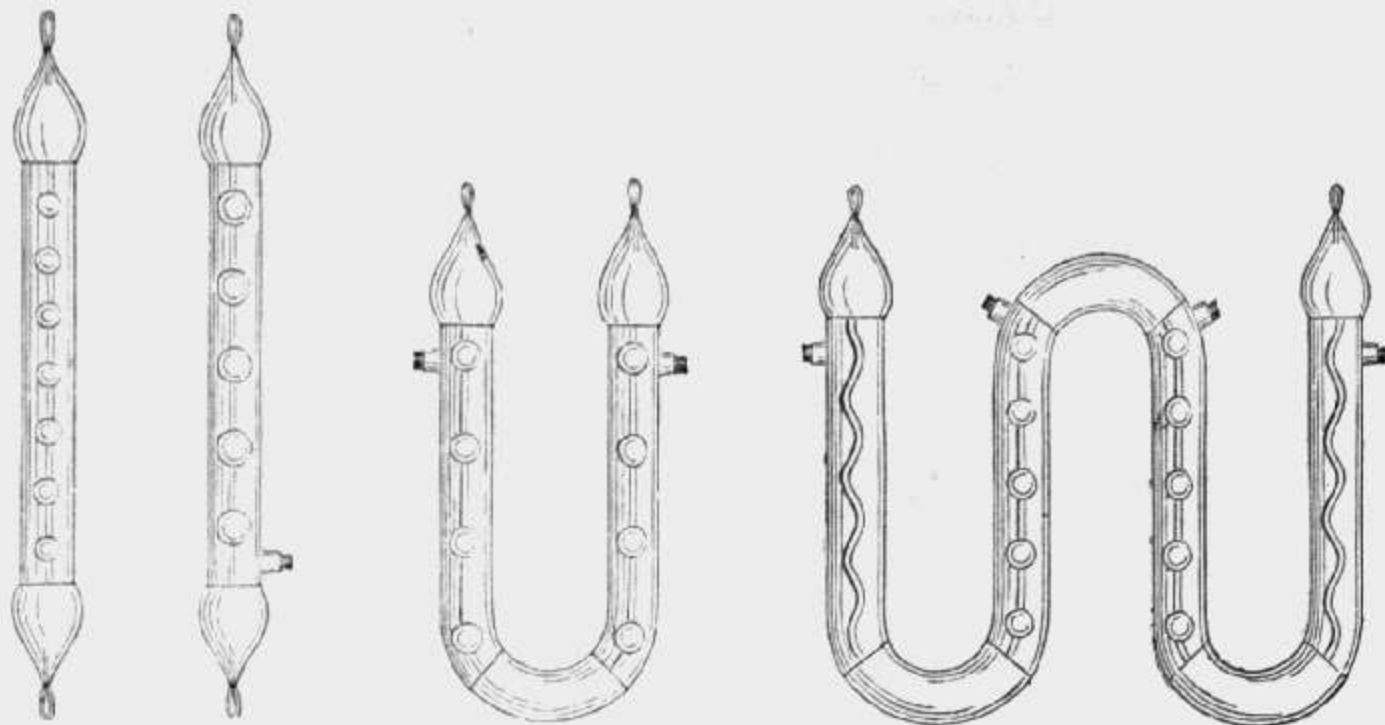

6331-34.

6335-38.

6339.

6340.

6325. Sulphate of Quinine, in Tartaric Acid, eight-ounce bottle.....	1 50
6326. Chlorophyll, in Alcohol, eight-ounce bottle.....	
6327. Esculine in Alcohol, eight-ounce bottle.....	
6329. Block of Uranium Glass. To show fluorecence when placed under an exhausted receiver upon the air-pump plate, on the passage of a strong discharge from the induction coil.....	2 50
6330. Block of Uranium Glass. Same as No. 6329, but encased in a polished walnut box, with soft lining.....	4 00
6331. Double Geissler Tube, 7 inches long, with balls or spirals of uranium glass, to show fluorecence.....	2 25
6332. Geissler Tube. Same as No. 6331, but 12 inches long.....	5 00
6333. Geissler Tube. Same as above, but 24 inches long.....	7 00
6334. Geissler Tube. Same as above, but 30 inches long.....	9 00
6335. Double Geissler Tube, 7 inches long; outer tube filled with a fluorescent solution.....	2 25
6336. Geissler Tube. Same as No. 6335, but 12 inches long.....	5 00
6337. Geissler Tube. Same as above, but 24 inches long.....	7 00
6338. Geissler Tube. Same as above, but 30 inches long.....	9 00
6339. Geissler Tube. Double tube, U form, with uranium balls or spirals on the inner tube, the outer to be filled with fluorescent solutions. Arms 9 or 10 inches long.....	5 00
6340. Geissler Tube. Double. Form of double U. Inner tube with uranium balls, or spirals. The four outer to be filled with various fluorescent solutions.....	12 00



3. ACTINISM.

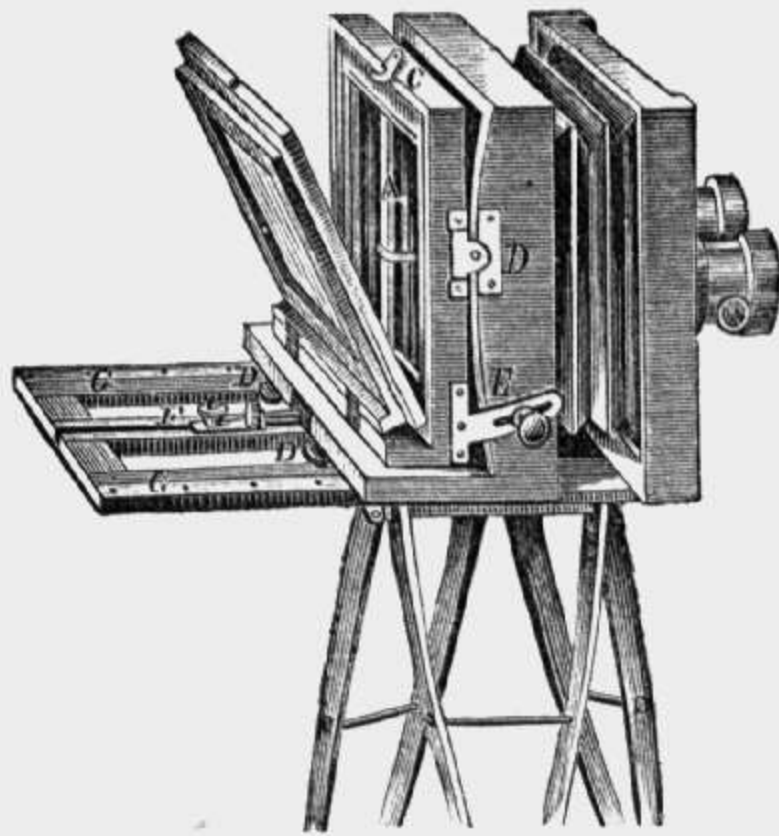

6350 and 6351.

- |  | PRICE   |
|--|---------|
| 6350. <b>Stereoscopic Camera Box.</b> For plates 5 inches by 8, with patent glass corner-holders, so arranged that the division between the two sides of the view may be removed, and, with one tube only, a picture be made covering the whole plate. By a simple contrivance, the box may be fastened upon the tripod on the side as well as the base, and thus the plate be held with its greatest length vertically, if desired. Without swing back..... | \$30 00 |
| 6351. <b>Stereoscopic Camera Box.</b> Same as No. 6350, but with patent single swing back.....   | 35 00   |

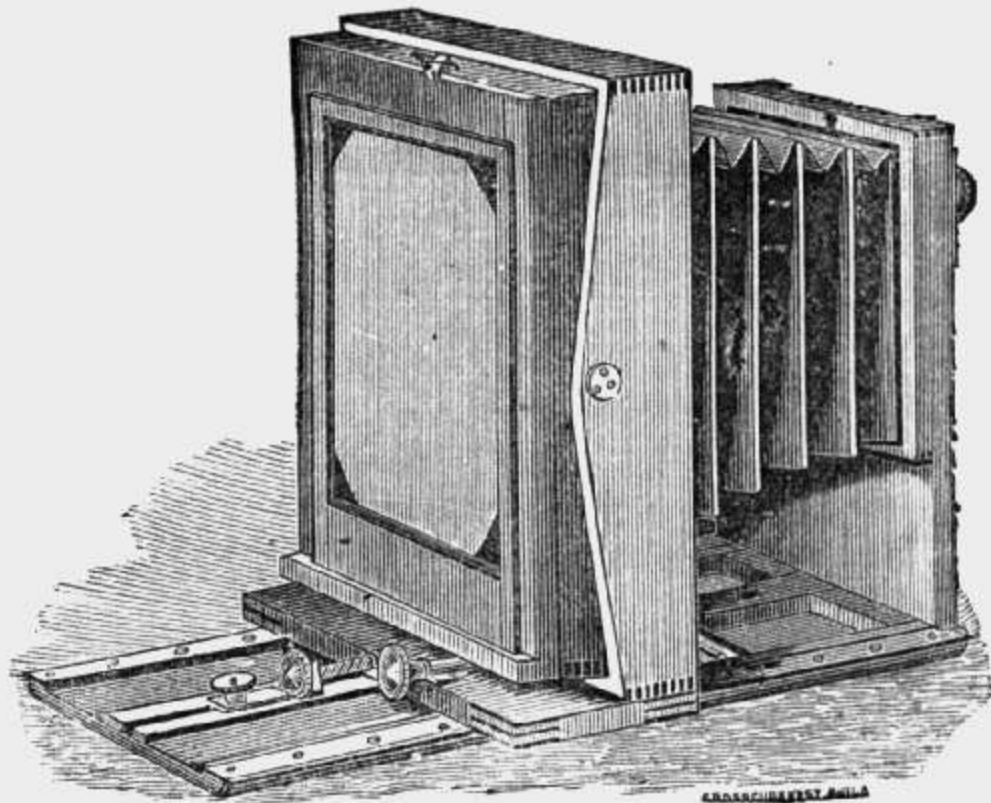

6352 to 6357.

- |  |       |
|--|-------|
| 6352. <b>Pyramidal View Camera Box.</b> Plate 6½ inches by 8½, reversible. Of polished mahogany, with rubber bellows, of pyramidal form, so as to shut closely for carrying, and with hinged base..... | 40 00 |
| 6353. <b>Pyramidal View Camera Box.</b> Same as No. 6352, but with single swing back.....  | 45 00 |

- 6354. **Pyramidal View Camera Box.** Same as No. 6352, but with double swing back. . . . . \$50 00
- 6355. **Pyramidal View Camera Box.** Similar to No. 6352, but for plates 10 inches by 12. . . . . 60 00
- 6356. **Pyramidal View Camera Box.** Same as No. 6355, but with single swing back. . . . . 65 00
- 6357. **Pyramidal View Camera Box.** Same as No. 6355, but with double swing back. . . . . 70 00

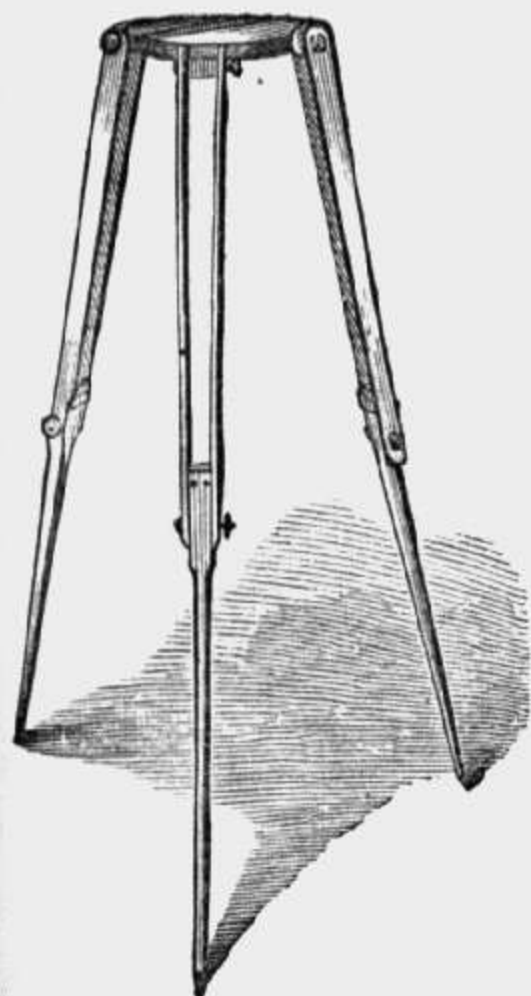

6358 and 6359.

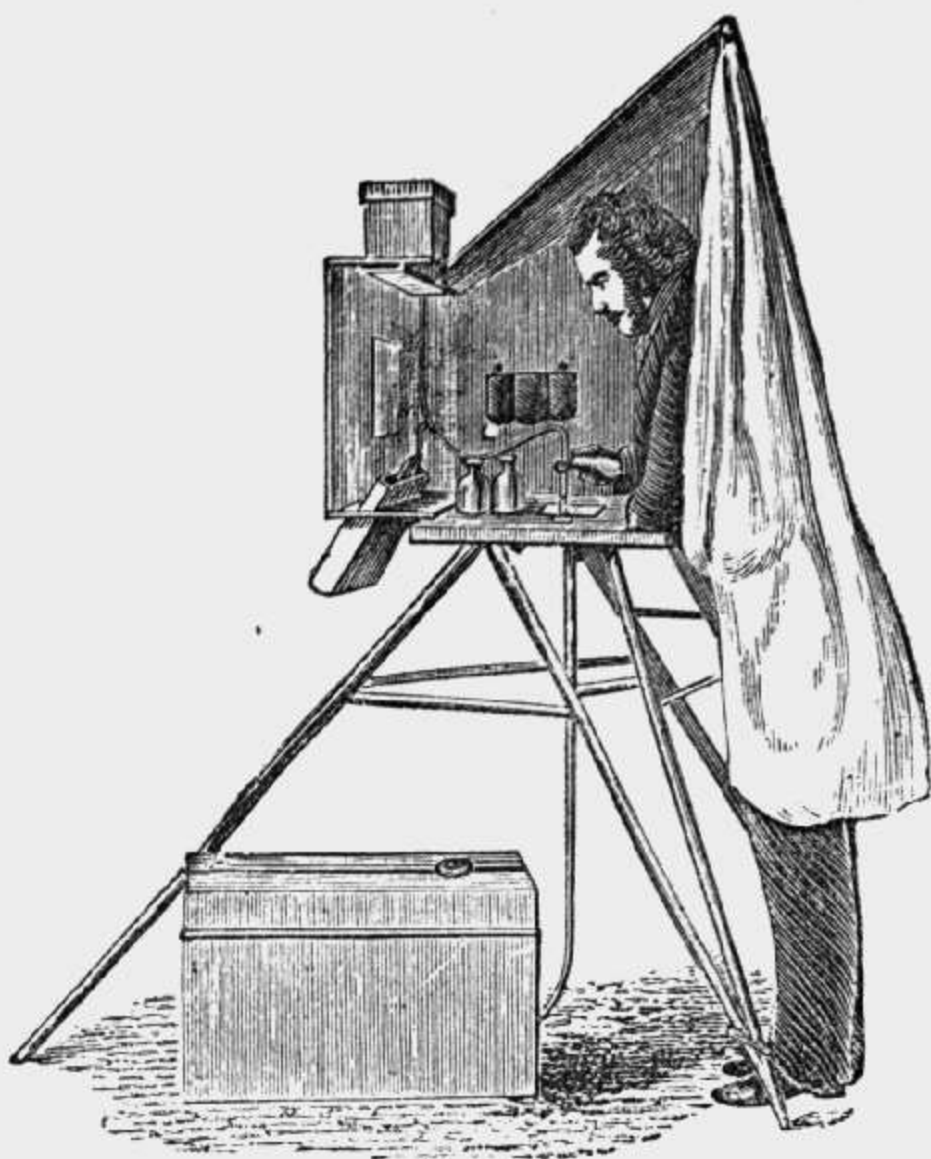

6367.

- 6358. **Tripod Stand.** For any of the foregoing camera boxes. Of light wood, with brass mountings. Firm and rigid when in use, but folding in small compass for packing. With 6-inch wooden top. . . . . 3 00
- 6359. **Tripod Stand.** Same as No. 6358, but with 12-inch wooden top. . . . . 5 00
- 6360. **Pair of View Lenses.** Suited also for copying engravings, etc., for Stereoscopic Camera box, No. 6350 and 6351. Per pair. . . . . 22 00
- 6361. **View Lens.** For Camera boxes Nos. 6352, 3, 4, covering the plate. . . . . 15 00
- 6362. **View Lens.** For Camera boxes Nos. 6355, 6, 7, covering the plate. . . . . 22 00
- 6363. **Glass Bath.** For nitrate of silver solution, inside measure, 7 inches by 9. . . . . 2 50
- 6364. **Glass Bath.** Same as No. 6363, but 11 inches by 13. . . . . 4 00
- 6365. **Nitrate of Silver, Chloride of Gold, Sulphate of Iron,** and all other materials for photographic use, at current market rates. . . . .
- 6366. **Micro-photographic Instrument.** Consisting, 1st, of porte lumière, with mirror 18 inches long by four wide, with adjustments for directing the light, and a condensing lens 4 inches in diameter. . . . .
- 2d. Of microscope body, with secondary condensers, holder for objects, and the following assortment of lenses :
  - One Photographic Objective 4-inch focus.
  - “ “ “ 2 “
  - “ “ “ 1 inch focus.
- 3d. Of a plain Camera, for plates from 4 inches square to 8 inches square. . . . . 150 00
- 6367 **Photographic Tent** for out-door work, very light, durable and portable. Suitable for plates up to 11 by 14 inches. . . . . 75 00



## SECTION VIII.—OF INTERFERENCE AND DIFFRACTION.

	PRICE
6375. <b>Two Mirrors</b> , adjustable to any angle with each other, on a brass stand with clamp.....	\$25 00
6376. <b>Apparatus</b> to permit the passage of a very narrow slit of light, adjustable, of brass.....	10 00
6377. <b>Double Prism of Mons. Pouillet</b> , mounted in brass frame on a brass stand with clamp.....	
6378. <b>Two Rectilinear Gratings</b> , ruled on glass, mounted in a brass frame on a brass stand, so that they can be rotated to assume any angle with each other, for projection of interferences.....	30 00
6379. <b>Circular Grating</b> . Mounted in a brass frame on a brass stand.....	25 00
6380. <b>Mica Plates</b> . Mounted in a brass frame, on brass stand, with clamp.	5 00
6381. <b>Newton's Apparatus</b> , to show interference in thin plates; consisting of a thick plate of glass, and a lens of long focus, mounted in a strong brass frame with clamps. Four inches in diameter.....	12 50
6382. <b>Newton's Apparatus</b> . For reflection only. Similar to No. 6381, but having a plate of black glass.....	17 50
6385. <b>Jamin's Apparatus</b> . To show interference in thick plates. A pair of thick plates of glass, mounted so as to be adjustable to any required angle with each other, and to any requisite distance apart, on a strong brass stand, with clamp.....	45 00
6386. <b>Set of Four Diffraction Slits</b> . Of different shapes. Mounted in brass frame on stand, with clamp.....	20 00
6387. <b>Interference Bench</b> . To hold all the above pieces of apparatus on interference and diffraction. Consisting of a graduated bar of brass, supported by a pair of posts on a frame of polished mahogany. Length of bar four feet. A telescope, with micrometer, accompanies the bench to measure the distance of the fringes. It is mounted, like the other pieces of the complete apparatus, on a brass stand, with clamp, and has a horizontal movement by means of a screw. With screens.....	200 00

## SECTION IX.—DOUBLE REFRACTION AND POLARIZATION.

6400. <b>Rhomb of Calc-Spar</b> . According to size and transparency...\$5 00 to 50 00	
6401. <b>Rhomb of Calc-Spar</b> . Cut so as to expose the axis.....	10 00
6402. <b>Achromatic Double Image Prism</b> . Three-fourths inch on side.....	7 50
6403. <b>Achromatic Double Image Prism</b> . One and a quarter inch on side..	15 00
6404. <b>Achromatic Double Image Prism</b> . Two inches on side.....	20 00

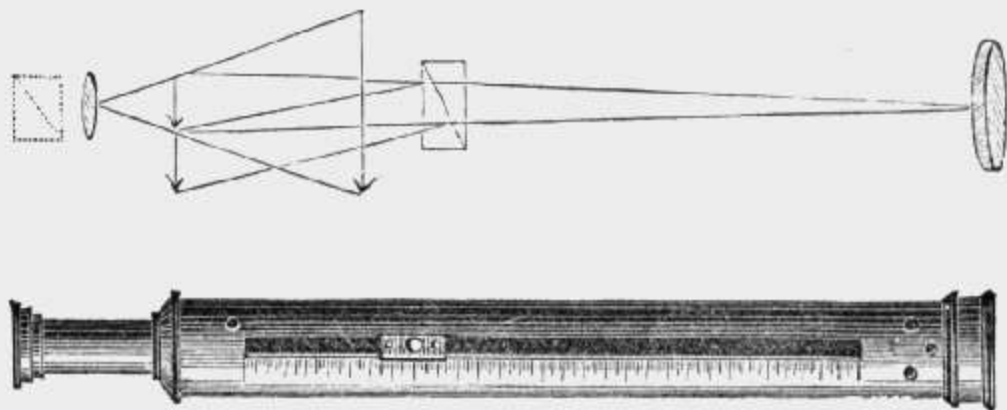

6406.

6406. <b>Rochon Telescope</b> . Which serves to measure the distance of an object if its size be known, by means of a Rochon Prism of Spar...	45 00
---	-------



6411-13.

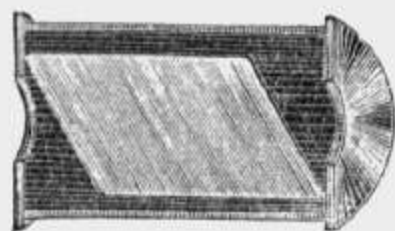

6422.

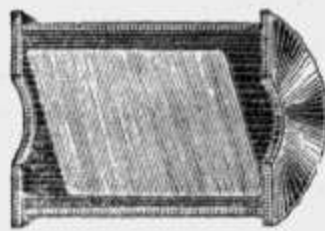

6425-29.

	PRICE
6408. <b>Plate of Polished Black Glass.</b> Mounted on a support so as to be inclined at any angle.....	\$20 00
6409. <b>Bundle of Glass Plates.</b> Carefully polished. Mounted in a brass tube, at the polarizing angle.....	25 00
6410. <b>Bundle of Glass Plates.</b> Carefully polished, and mounted in a brass tube. So arranged as to allow both the reflected and refracted rays to be employed.....	30 00
6411. <b>Pair of Tourmalines.</b> In tongs.....	5 00
6412. <b>Pair of Tourmaline Tongs.</b> Finer quality.....	10 00
6413. <b>Pair of Tourmaline Tongs.</b> Three-fourths of an inch in diameter...	20 00
6414. <b>Pair of Tourmaline Plates.</b> Cut parallel to the axis, and mounted in a brass frame, so as to be rotated and crossed at will, to show the extinction of the light.....	20 00
6415. <b>Nicol's Prism.</b> Unmounted, 8 millimetres across the face.....	3 00
6416. <b>Nicol's Prism.</b> Unmounted, 10 millimetres across the face.....	4 00
6417. <b>Nicol's Prism.</b> Unmounted, 12 millimetres across the face.....	5 00
6418. <b>Nicol's Prism.</b> Unmounted, 16 millimetres across the face.....	10 00
6419. <b>Nicol's Prism.</b> Unmounted, 20 millimetres across the face.....	14 00
6420. <b>Nicol's Prism.</b> Unmounted, 30 millimetres across the face.....	50 00
6421. <b>Nicol's Prism.</b> Unmounted, 40 millimetres across the face.....	90 00
6422. <b>Brass Mountings for Nicol's Prisms,</b> Nos. 6415-21, with cork setting and glass ends. <i>Without prism.</i> According to size. Each, from.....	\$1 00 to \$10 00
6423. <b>Pair of Nicol's Prisms.</b> 12 millimetres in diameter. Mounted in a neat brass frame, with handle, so that each prism can be rotated at pleasure. With holder for object, and lens for giving diverging rays. Very suitable for examining the rings in crystals.....	20 00
6424. <b>Pair of Nicol's Prisms,</b> 16 millimetres in diameter. Mounted same as No. 6422.....	25 00
6425. <b>Foucault's Prism.</b> For polarization of parallel rays. 12 millimetres across the face. Mounted in brass cell.....	6 00
6426. <b>Foucault's Prism.</b> Same as No. 6424, but 16 millimetres across.....	15 00
6427. <b>Foucault's Prism.</b> Ditto, but 30 millimetres across.....	25 00
6428. <b>Foucault's Prism.</b> Ditto, but 40 millimetres across.....	40 00
6429. <b>Foucault's Prism.</b> Ditto, but 60 millimetres across.....	100 00
6435. <b>Hoffmann's New Polarizing Prism.</b> 12 millimetres opening. Mounted in brass cell.....	10 50
6436. <b>Hoffmann's Prism.</b> Same as No. 6435, but 15 millimetres opening..	15 00
6437. <b>Hoffmann's Prism.</b> Same as No. 6435. 20 millimetres opening.....	36 00
6438. <b>Hoffmann's Prism.</b> Same as No. 6435. 25 millimetres opening.....	50 00
6439. <b>Hoffmann's Prism.</b> Same as No. 6435. 30 millimetres opening.....	75 00
6440. <b>Hoffmann's Prism.</b> Same as No. 6435. 35 millimetres opening.....	90 00
6441. <b>Hoffmann's Prism.</b> Same as No. 6435. 40 millimetres opening.....	135 00



	PRICE
6442. <b>Hoffmann's Prism.</b> Same as No. 6435. 45 millimetres opening.....	\$180 00
6443. <b>Hoffmann's Prism.</b> Same as No. 6435. 50 millimetres opening.....	250 00
6444. <b>Hoffmann's Prism.</b> Same as No. 6435. 55 millimetres opening.....	315 00
6445. <b>Hoffmann's Prism.</b> Same as No. 6435. 60 millimetres opening.....	375 00
6460. <b>Plate of Selenite</b> , of uniform thickness; tints, red and green.....	2 50
6461. <b>Plate of Selenite</b> , of uniform thickness; tints, yellow and blue.....	2 50
6462. <b>Plate of Selenite</b> , in the form of a concave lens, showing the various tints of the spectrum in order.....	10 00
6463. <b>Plate of Mica</b> , of uniform thickness; tints, red and green.....	1 50
6464. <b>Plate of Mica</b> , of uniform thickness; tints, yellow and blue.....	1 50
6465. <b>Plate of Selenite</b> , of uneven thickness, giving various tints.....	1 50
6466. <b>Plate of Mica</b> , of uneven thickness, giving various tints.....	1 50
6467. <b>Plate of Quartz</b> , cut parallel to the axis; thin.....	3 00
6468. <b>Plate of Quartz</b> , cut parallel to the axis; thick.....	3 00
6469. <b>Series of seven plates of Quartz</b> , cut parallel to the axis, giving the tints of the spectrum.....	24 00
6470. <b>Plate of Quartz</b> , cut parallel to the axis, and ground into the form of a concave lens, to show the colors due to different thicknesses in a succession of rays.....	10 00
6471. <b>Plate of Quartz (oblique)</b> , giving hyperbolas, single.....	3 50
6472. <b>Plate of Quartz (oblique)</b> , giving hyperbolas, double.....	6 00
6473. <b>Plate of Calc-Spar</b> , giving hyperbolas, single.....	3 00
6474. <b>Plate of Calc-Spar</b> , giving hyperbolas, double.....	3 00
6475. <b>Plate of Quartz</b> , giving <i>sensitive tint</i> .....	3 00
6476. <b>Plate of Mica</b> , giving sensitive tint.....	3 00
6477. <b>Plate of Selenite</b> , giving sensitive tint.....	3 00

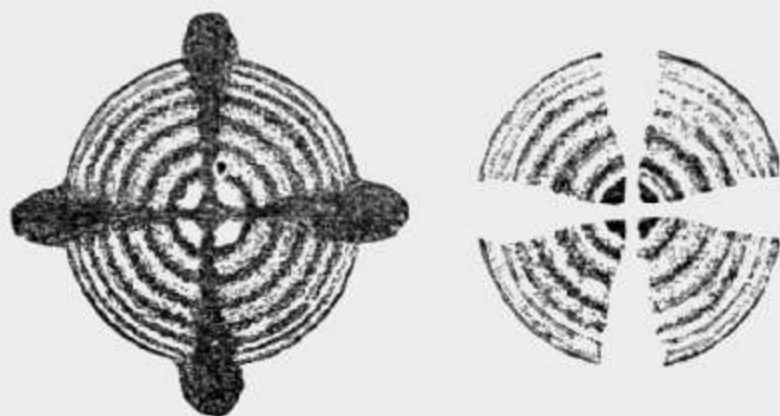

6478.

- |  |      |
|--|------|
| 6478. <b>Plate of Calc-Spar</b> cut perpendicular to the axis, and giving the circles and cross..... | 2 00 |
| 6479. <b>Plate of Sulphate of Nickel</b> , cut perpendicular to the axis.....                        | 3 50 |

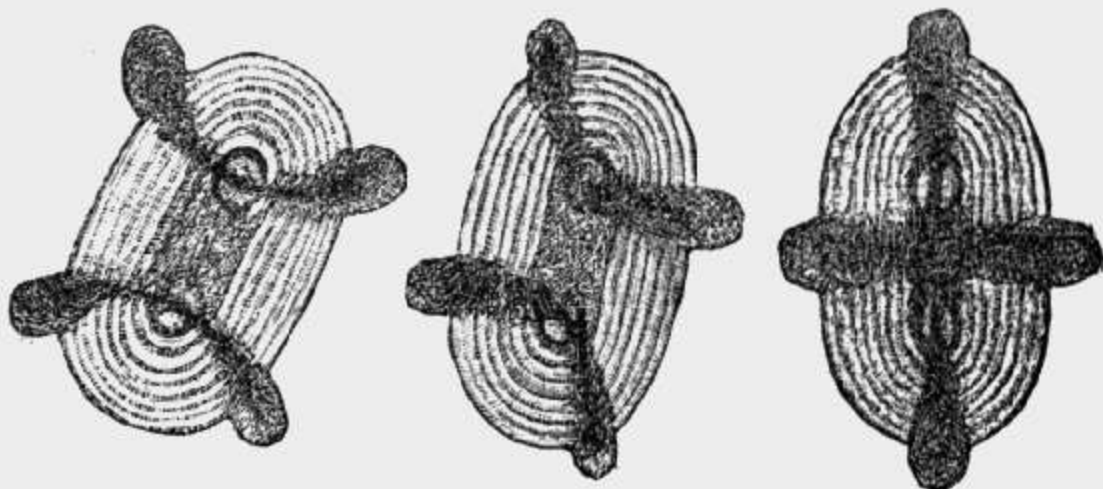

6490.

	PRICE
6490. Plate of Nitre, cut perpendicular to the median line, so as to show both systems of rings. ....	\$3 00
6491. Plate of Sugar. Perpendicular to the median line. ....	2 50
6492. Plate of Arragonite. Perpendicular to the median line. ....	4 00
6493. Plate of Chromate of Potash. Perpendicular to the median line. ....	2 50
6494. Plate of Quartz. Cut perpendicular to the axis, left-handed. ....	5 00
6495. Plate of Quartz. Cut perpendicular to the axis, right-handed. ....	5 00
6496. Compound Plate of Quartz. One half left-handed and the other right-handed. ....	10 00
6497. Compound Plate of Quartz, giving the spirals of Airy. ....	8 00
6500. Babinet's Compensating Prism. ....	10 00
6501. Calc-Spar. Cut perpendicular to the axis, to show phenomena of hemitropic crystals. ....	5 00
6502. Film of Mica, of one-quarter wave, for circular polarization, per pair	8 00
6503. Fresnel's Rhomb, for circular polarization, in brass case, per pair. ...	30 00



6510.

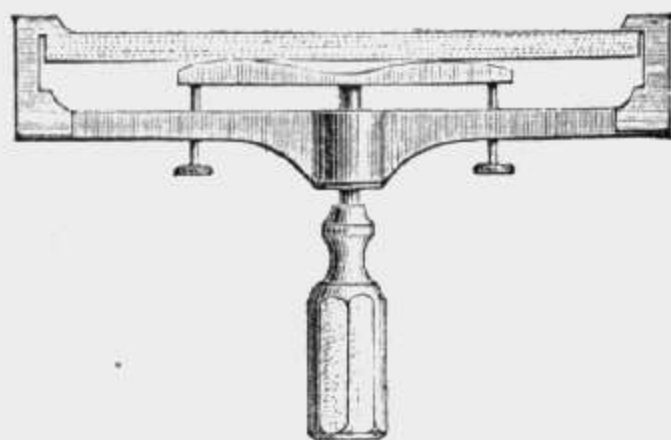

6511.



6512.

6505. Verre Trempe. Square form, 1 inch across. ....	3 00
6506. Verre Trempe. Triangular form, 1 inch on a side. ....	3 00
6507. Verre Trempe. Rectangular form, 1 inch long. ....	3 00
6508. Verre Trempe. Pentagonal form, 1 inch across. ....	3 00
6509. Verre Trempe. Hexagonal form, 1 inch across. ....	3 00
6510. Brass Frame, with handle, to show the effect of heat upon glass. ....	7 50
6511. Brass Frame, with screw-press, to show the effect of transverse strain upon a bar of glass placed in it. ....	12 50
6512. Brass Frame, with screw-press to show the effect of the strain upon the structure of a block of plate-glass placed in it. ....	12 50
6515. Selenite Films of uneven thickness, figure of a star. ....	\$3 00 to 10 00
6516. Selenite Films. Similar to No. 6515, figure of bird. ....	\$3 00 to 12 00
6517. Selenite Film. As above, figure of butterfly. ....	3 00 to 12 00
6518. Selenite Film. Figure of bunch of grapes. ....	3 00 to 12 00
6519. Selenite Film. Figure of a crown. ....	3 00 to 12 00
6520. Selenite Film. Figure of tetrahedron. ....	3 00
6521. Selenite Film. Figure of octahedron. ....	3 00



2.—ON THE PROJECTION OF THE PHENOMENA OF DOUBLE REFRACTION AND POLARIZATION.

	PRICE
6550. <b>Double Image Prisms for Projection.</b> Consisting of a pair of double image prisms, $\frac{3}{4}$ inch in diameter, with selenite plate, to demonstrate to a large audience the phenomena of double refraction and complementary colors. Mounted in brass, on plain stand.....	\$25 00
6551. Double Image Prisms for Projection. Similar to No. 6550, but one and a quarter inches across.....	40 00
6552. Double Image Prisms for Projection. Similar to No. 6550, but 2 inches across.....	80 00
6561. <b>Polariscope for Projection.</b> Consisting of a bundle of glass plates for polarizer, arranged to show the polarization of both the reflected and refracted rays, with a Nicol's prism, 20 millimetres across the face, for analyzer; a lens for focusing the object, and a stage for holding it. Mountings of brass.....	75 00
6562. Polariscope for Projection. Consisting of a Foucault prism, $1\frac{1}{2}$ inches in diameter, for a polarizer, a Nicol's prism, 20 millimetres across the face, as an analyzer; a lens for focusing the object, and a stage for holding it.....	75 00
6563. Polariscope for Projection. Consisting of a Foucault prism, $2\frac{1}{2}$ inches in diameter, as a polarizer, a Nicol's prism, $1\frac{1}{2}$ inches in diameter, as an analyzer, a lens for focusing the object, and a stage for holding it.....	200 00
6564. Polariscope for Projection. Consisting of a Nicol's prism, 3 inches in diameter, as a polarizer, a Nicol's prism, 2 inches in diameter, as an analyzer, a lens for focusing the objects, and a stage for holding it.	800 00
6566. Polariscope for Projection. Consisting of a Hoffmann's prism, of 30 millimetres opening as a polarizer, a Hoffmann's prism of 20 millimetres opening as an analyzer, a lens for focusing the object, and a stage for holding it.....	150 00
6567. Polariscope for Projection. Consisting of a Hoffmann's prism, of 45 millimetres opening as a polarizer, a Hoffmann's prism of 30 millimetres opening as an analyzer, a lens for focusing the object, and a stage for holding it.....	315 00
6568. Polariscope for Projection. Consisting of a Hoffmann's prism, of 60 millimetres opening as a polarizer, a Hoffmann's prism of 45 millimetres opening, as an analyzer, a lens for focusing the object, and a stage for holding it.....	625 00

All the above polariscopes for projection are intended to be attached to any good hydro-oxygen or electric lantern, or to a heliostat, in case sunlight is used. They are neatly mounted, so as to admit all the needed movements, in brass fittings, upon polished mahogany bases.

3.—POLARISCOPES FOR THE STUDY OF ATMOSPHERIC POLARIZATION, &c.

6600. <b>Polariscope of Babinet.</b> Consisting of a plate of " <i>verre trempé</i> ," at one end of a brass tube 10 inches long, and a tourmaline plate or Nicol's prism at the other.....	15 00
6601. <b>Polariscope of Savart.</b> Consisting of a double plate of quartz, and a tourmaline plate, in a small brass cell.....	10 00
6602. <b>Polariscope of Arago.</b> Consisting of a double plate of quartz, and a double refracting prism, placed at opposite ends of a brass tube, 10 inches long.....	24 00
6603. <b>Polariscope of Senarmont.</b> Consisting of a double compound prism of right-handed and left-handed quartz, and a tourmaline or Nicol's prism set in a brass tube.....	24 00

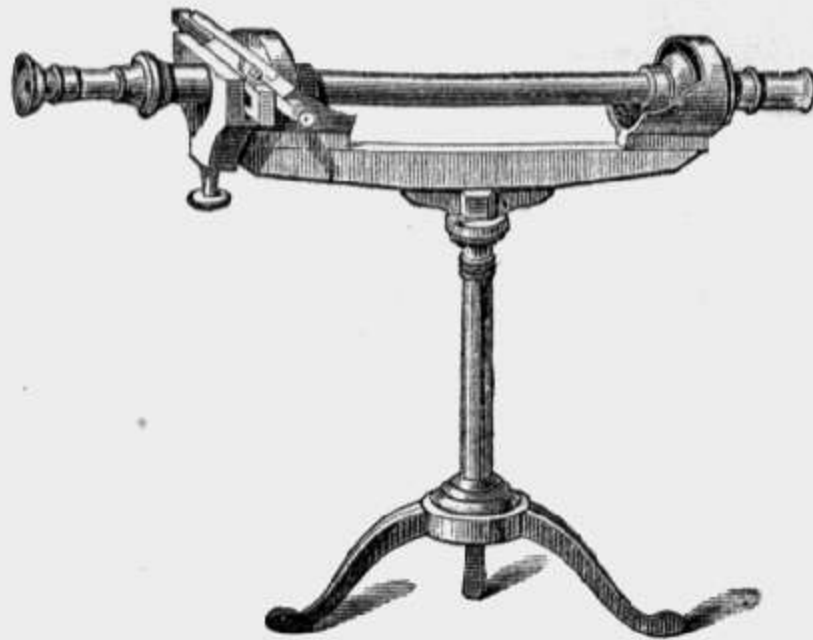

6605.

	PRICE
6604. <b>Mitscherlich's Apparatus</b> , for investigating the laws of rotary polarization.....	\$60 00
6605. <b>Soleil's Saccharimeter</b> , with four tubes, three of brass, and one of glass, for the fluid. Full instructions for use accompany each instrument.....	130 00

SECTION X.—ON VISION.

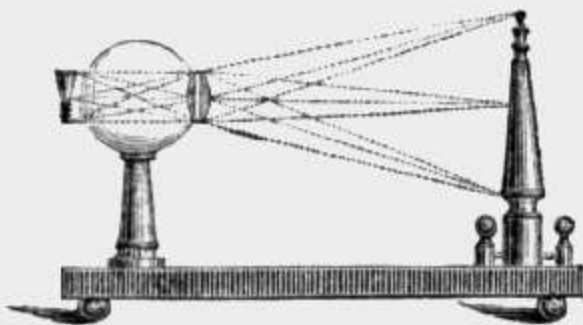

6620.

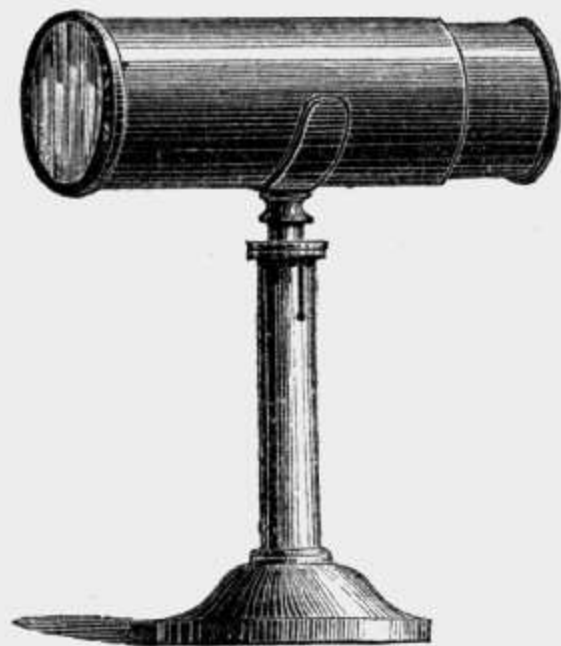

6621.

6620. <b>Apparatus Illustrating the Formation of Images in the Eye</b> . Mounted on a neat mahogany frame.....	7 50
6621. <b>Apparatus Illustrating the Cause of Long and Short Sight</b> . Pair of brass tubes, with a ground-glass screen at one end and three lenses of different foci at the other.....	15 00
6622. <b>Model of the Eye</b> . Showing the different coats, lenses, &c. Three inches in diameter.....	8 00
6623. <b>Model of the Eye</b> . Showing the muscles which move it, the arteries and veins which supply it, and the various coatings, lenses, and humors of which it is composed. So constructed as to be taken in pieces and studied in detail. The globe of the eye is represented on a scale of 4 inches in diameter.....	40 00



2.—PERSISTENCE OF VISION.

	PRICE
6630. <b>Anorthoscope.</b> Consisting of two wheels of card-board, twenty inches in diameter, to be rotated on the same axis with equal velocity in opposite directions. Each of them is cut by an equal number of the same sized rays. Mounted on a neat, firm rotating stand of polished mahogany.....	\$20 00
6631. <b>Thaumatrope</b> .....	5 00
6632. <b>Photodrome.</b> Consisting of a strong rotator, carrying three discs of devices, each thirty inches in diameter, painted on paper; and a small rotator carrying a smaller disc of card-board, with openings in it, to allow the light from a calcium, magnesium, or electric lantern to be thrown upon the first disc by flashes. Each rotator is revolved rapidly, producing the most curious effects upon the large disc....	50 00
6633. <b>Zoetrope, or Wheel of Life</b> .....	3 50
6634. <b>Zoetrope, or Wheel of Life.</b> For projection by the calcium, magnesium, or electric lantern.....	15 00

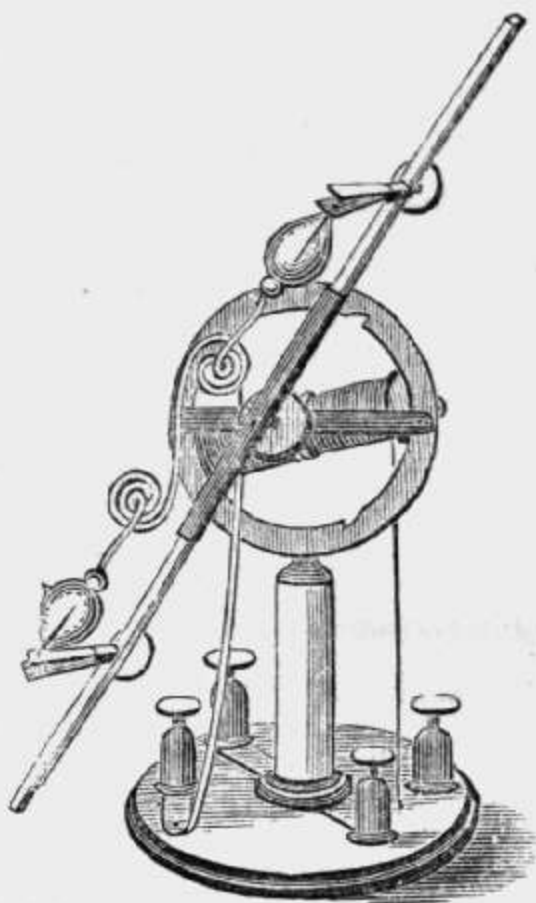

6635.

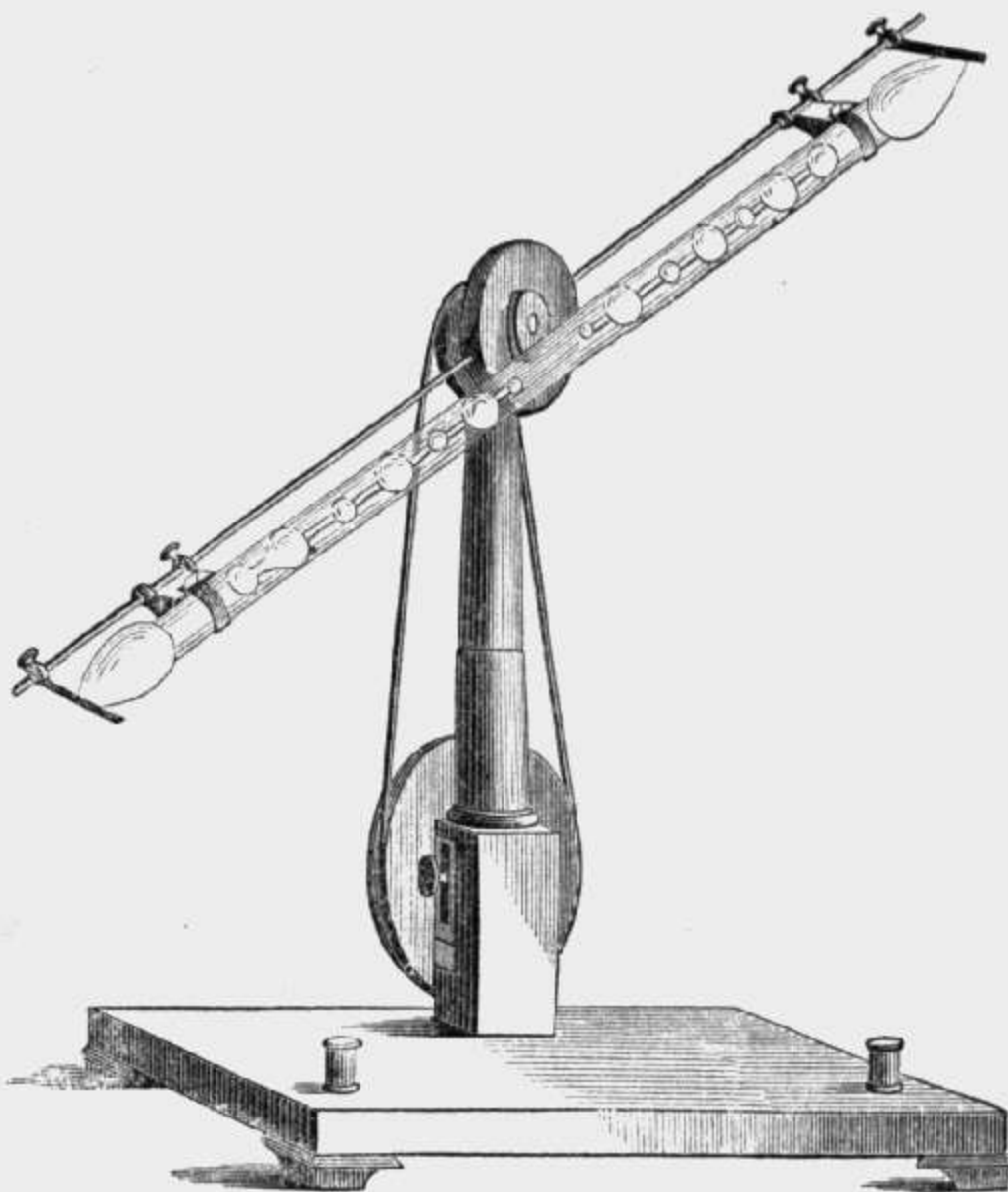

6639.

6635. <b>Automatic Rotator</b> for Geissler's Tubes, and a set of six tubes. Selected for their especial fitness for this use. Tubes each from seven to nine inches long, in a neat box.....	17 50
6636. <b>Automatic Rotator, No. 6635, without</b> the tubes.....	10 00
6637. <b>Automatic Rotator</b> for Geissler's Tubes. Larger and more elegant model, carrying tubes from seven to twelve inches long, <i>without</i> tubes.....	20 00
6638. <b>Automatic Rotator</b> for Geissler's Tubes. Grand model, without tubes.	30 00
6639. <b>Rotator for Geissler's Tubes.</b> Of mahogany, not automatic, and carrying tubes from twelve to thirty inches long.....	30 00
6640. <b>Grand Rotator</b> for Geissler's Tubes. Of mahogany, with two or four arms, suitable for carrying either one tube from twenty to forty-eight inches long, or four tubes each twenty inches long, as may be desired.....	75 00

3.—BINOCULAR VISION.



6646.

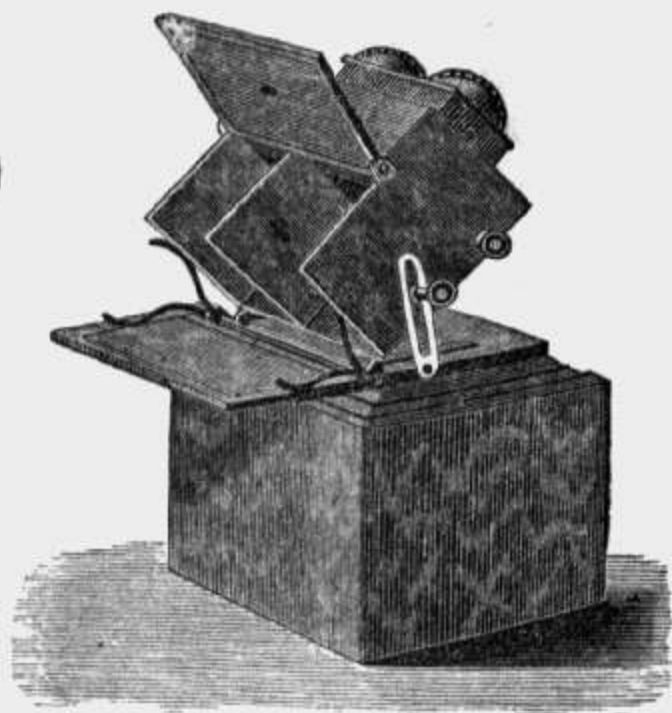

6647 and 6648.



6649 and 6650.

	PRICE
6645. Reflecting Stereoscope of Mr. Wheatstone.....	\$8 00
6646. Refracting Stereoscope of Sir David Brewster. Neat rosewood frame, Holmes' form, on stand.....	6 00
6647. Achromatic Refracting Stereoscope of Sir David Brewster. Of highly polished mahogany, in case of the same material.....	27 50
6648. Achromatic Refracting Stereoscope of Sir David Brewster. Of highly polished black walnut, in case of the same material.....	33 00
6649. Achromatic Refracting Stereoscope of Sir David Brewster, with reflector. Of highly polished mahogany.....	17 50
6650. Achromatic Refracting Stereoscope of Sir David Brewster, with reflector. Of highly polished black walnut.....	20 00

4.—ACCIDENTAL COLORS.

6655. A frame of polished mahogany, two feet square, standing vertically, on base of same material, and intended to support two pieces of heavy paper, one white, the other black. A set of ten white and brilliantly colored discs accompany the instrument, to be fastened at the middle of the former two. Full directions for use with each instrument.....	15 00
---	-------

5.—HARMONY AND MUTUAL INFLUENCE OF COLORS.

6656. A frame of polished mahogany, two feet square, standing vertically, intended to support in turn the following discs and squares:—

- |        |   |
|--------|---|
| No. 1. | A square piece of white paper, two feet square. |
| 2.     | “ “ black “ “                                   |
| 3.     | “ “ gray “ “                                    |
| 4.     | “ “ red “ “                                     |
| 5.     | “ “ orange “ “                                  |
| 6.     | “ “ yellow “ “                                  |
| 7.     | “ “ green “ “                                   |
| 8.     | “ “ blue “ “                                    |
| 9.     | “ “ indigo “ “                                  |
| 10.    | “ “ violet “ “                                  |

Beside these *ground* tints, the following colored discs, each ten inches in diameter, are attached as desired at the centre. Black, gray, white, red, orange, yellow, green, blue, indigo, and violet....

20 00



## SECTION XI.—INSTRUMENTS FOR PROJECTION.

All of the instruments described below are fitted so as to be used either with the Electric Lamp, for spectrum projection, No. 5581, the lamps of Browning, Nos. 5585 and 5586; the Electric Regulators of Duboscq and Foucault, Nos. 5587 and 5588; the Magnesium Lamp, No. 6061, or the Hydro-Oxygen Lime Lamp, No. 6050, or 6051.

(Cut in Next Edition.)

**Cheyney's Universal Lantern for Projection, made entirely of metal.**

The frame of these lanterns consists of two strong plates of metal at right angles to each other, one the base, the other the face or front. The condensers are carried by the latter and the lamp by the former, each being securely fastened. A hood covers the light. The magnifying lenses are borne by a stout metal bar and post, attached to the front of the frame. This (which may be called the *optical* part of the instrument) is supported upon a stout frame by four pillars, rising from a circular metal base; and has, fastened to its under surface, two strong metal arcs. On an axis joining the centre of these the instrument rotates in a *vertical plane*. When used to project the light, either in a horizontal or vertical direction, the lantern-frame is securely bolted to the frame of the base by a series of strong pins. When the front of the lantern is either elevated or depressed, a pair of pins in each of the metal arcs holds it firmly in any position.

The whole instrument, above described, rotates in a *horizontal plane* upon a heavy circular plate of metal, and, to avoid friction, the upper of the two circular plates forming the base, has a groove cut in it, and three steel balls, placed at equal distances apart, serve as friction rollers. A clamp fixes it firmly in any desired position.

The instrument has thus complete movements in all directions, and can be used as a horizontal or vertical lantern, at will, by merely turning it on its axis. The facility with which the light can be directed downward or upward, at any angle, as well as its free movement in a horizontal direction, gives this instrument an advantage over every other form of instrument for projection; while a long experience has

shown that there is no danger of injury to the condensers in using the light immediately beneath them, if they are carefully warmed by using the light a short time in the usual position, before turning the instrument vertically. As the arrangement of lenses used in the vertical lantern is the same as in the instrument used in the ordinary way, the field is just as clear as in the latter case. A square prism set above the magnifying lens, throws the light upon the screen.

	PRICE
6660. <b>Universal Lantern.</b> As described above, with condensers four and a half inches in diameter, and a series of three achromatic magnifying lenses two inches in diameter, of four, seven and a half, and twelve inches respective focus. No lamps. ....	\$175 00
6661. <b>Universal Lantern.</b> With two sets of condensers, one 4½ inches in diameter, the other 8 inches, and a series of four achromatic magnifying lenses, 2½ inches in diameter, and of 4, 7½, 12, and 20 inches focus, respectively. No lamps. ....	275 00
6662. <b>Universal Lantern.</b> No. 6660, with the following accessories: Glass tank, with brass clamps, for chemical reactions, No. 4036. .... Galvanic cell, No. 5461. .... Microscope for projection, No. 6366, pt. 2d. .... Spectroscope, No. 6290. .... Achromatic lens on stand, No. 6186. .... Fine square prism for inverting field, No. 6155. ....	325 00
6663. <b>Universal Lantern,</b> No. 6660, with the following accessories: Glass tank, with brass clamps, for chemical reactions, No. 4036. .... Galvanic cell, No. 5461. .... Microscope for projection, No. 6366, pt. 2d. .... Spectroscope, No. 6290. .... Polariscope, No. 6562. .... Kaleidoscope, No. 6098. .... Achromatic lens on stand, No. 6186. .... Fine square prism for inverting field, No. 6155. ....	415 00
6664. <b>Universal Lantern.</b> No. 6660, with the following accessories: Glass tank, with brass clamps, for chemical reactions, No. 4036. .... Galvanic cell, No. 5461. .... Microscope for projection, No. 6366, pt. 2d. .... Spectroscope, No. 6290. .... Polariscope, No. 6563. .... Kaleidoscope, No. 6098. .... Achromatic lens on stand, No. 6187. .... Fine square prism for inverting field, No. 6155. ....	525 00
6666. <b>Universal Lantern,</b> No. 6661, with the following accessories: Three Glass tanks, with brass clamps, for chemical reaction. Two large and one small. .... One Glass tank, No. 4036. .... Galvanic cell, No. 5461. .... Microscope for projection, No. 6366, pt. 2d. .... Spectroscope, No. 6290. .... Polariscope, No. 6564. .... Kaleidoscope, No. 6098. .... Achromatic lens on stand, No. 6187. .... Attachment for showing the Chladni figures on glass plates by projection, No. 4722. .... Large square prism for inverting the field, No. 6155. ....	1200 00

For the ordinary lanterns for exhibition, and for full list of scientific and other pictures, see our Catalogue, Part 3d.



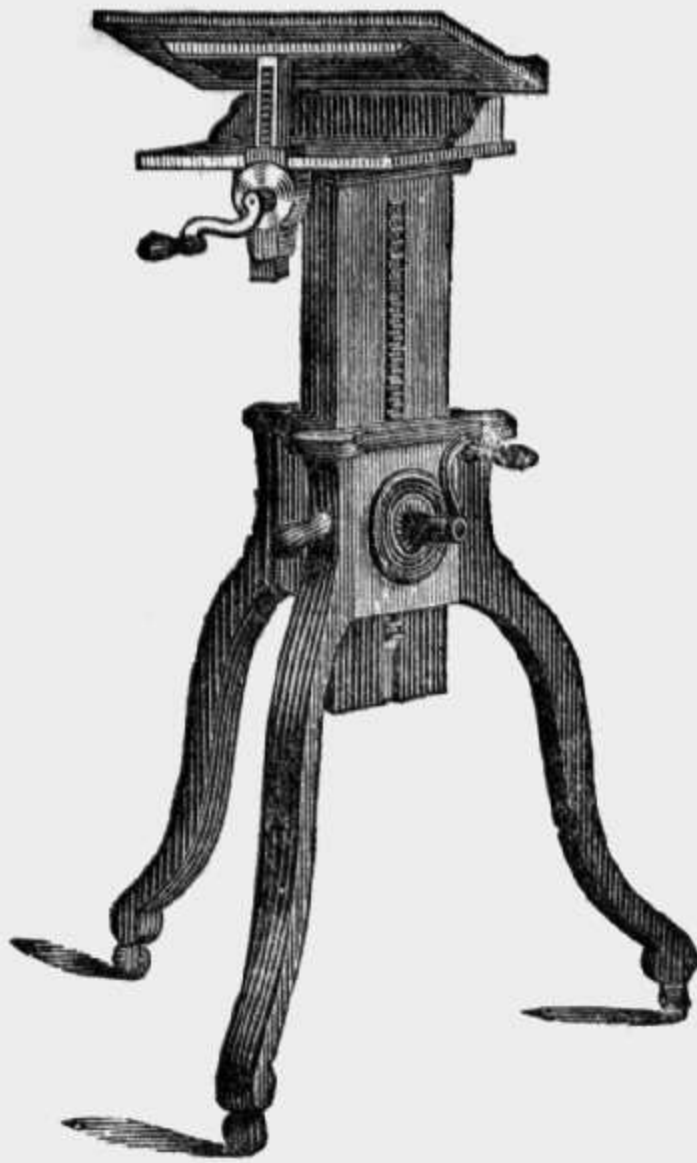

6676.

	PRICE
6675. Elevating and Adjusting Stand for Lanterns, 6660 to 6666. Made very substantially of black walnut, finely polished, with iron rack-work, for elevation. Plain metal finish. . . . .	\$30 00
6676. Elevating and Adjusting Stand, similar to No. 6675, but with nickel-plated metal finish.. . . .	35 00

## CHAPTER IX.

## ASTRONOMY.

## SECTION I.—GLOBES WITH SEAS REPRESENTED WHITE, WITHOUT CURRENTS.

6680. Terrestrial Globe, six inches in diameter, on semi stand. . . . .	5 00
6681. Terrestrial Globe, six inches in diameter, on full mahogany stand. . . .	10 00
6682. Terrestrial Globe, ten inches in diameter, on full mahogany stand . . .	18 00
6683. Terrestrial Globe, ten inches in diameter, on bronzed stand. . . . .	20 00
6684. Terrestrial Globe, twelve inches in diameter, on semi-stand. . . . .	17 00
6685. Terrestrial Globe, twelve inches in diameter, on full mahogany stand.	22 00
6686. Terrestrial Globe, twelve inches in diameter, on bronzed pedestal stand	37 50
6687. Terrestrial Globe, sixteen inches in diameter, on bronzed pedestal stand. . . . .	62 50

	PRICE
6688. Terrestrial Globe, thirty inches in diameter, on full mahogany stand with compass.....	\$275 00
6689. Celestial Globe, six inches in diameter, on semi-stand.....	5 00
6690. Celestial Globe, six inches in diameter, on full mahogany stand.....	10 00
6691. Celestial Globe, ten inches in diameter, on full mahogany stand.....	18 00
6692. Celestial Globe, ten inches in diameter, on bronzed stand.....	20 00
6693. Celestial Globe, twelve inches in diameter, on full mahogany stand..	22 00
6694. Celestial Globe, twelve inches in diameter, on bronzed pedestal stand.	37 50
6695. Celestial Globe, sixteen inches in diameter, on bronzed pedestal stand.	62 50



6697.

6697. Solar Telluric Globe. Six inches in diameter, with descriptive manual of thirty pages. The arrangement of this instrument shows the cause of the seasons, of the different lengths of the day in different latitudes, etc., etc.....	15 00
--	-------

SECTION II.—GLOBES WITH SEAS REPRESENTED BLUE AND WITH OCEANIC CURRENTS.

6700. Terrestrial Globe. Six inches in diameter, on plain bronzed stand, with inclined axis.....	4 00
6701. Terrestrial Globe. Six inches in diameter, on plain bronzed stand, with full meridian and inclined axis.....	5 00
6702. Terrestrial Globe. Nine inches in diameter, on plain iron stand, with inclined axis.....	9 00
6703. Terrestrial Globe. Nine inches in diameter, on bronzed stand, with full meridian and inclined axis.....	12 00
6704. Terrestrial Globe. Nine inches in diameter, on low bronzed frame, with horizon, meridian and hour circle.....	16 00
6705. Terrestrial Globe. Twelve inches in diameter, on plain iron stand, with inclined axis.....	15 00
6706. Terrestrial Globe. Twelve inches in diameter, on bronzed stand, with full meridian and inclined axis.....	18 00



	PRICE
6707. Terrestrial Globe. Twelve inches in diameter, on low bronzed frame, with horizon, meridian, hour circle and quadrant.....	\$25 00
6708. Terrestrial Globe. Twenty inches in diameter, on bronzed pedestal frame, with full meridian and inclined axis.....	50 00
6709. Terrestrial Globe. Twenty inches in diameter, on bronzed pedestal frame, similar to No. 6708, but more finely finished.....	60 00
6710. Terrestrial Globe. Twenty inches in diameter, on bronzed pedestal frame, forty-two inches high, with horizon, meridian, hour circle and quadrant.....	65 00
6711. Terrestrial Globe. Twenty inches in diameter, on bronzed pedestal frame similar to No. 6710, but more finely finished.....	75 00

## SECTION III.—TELLURIANS AND PLANETARIUMS.

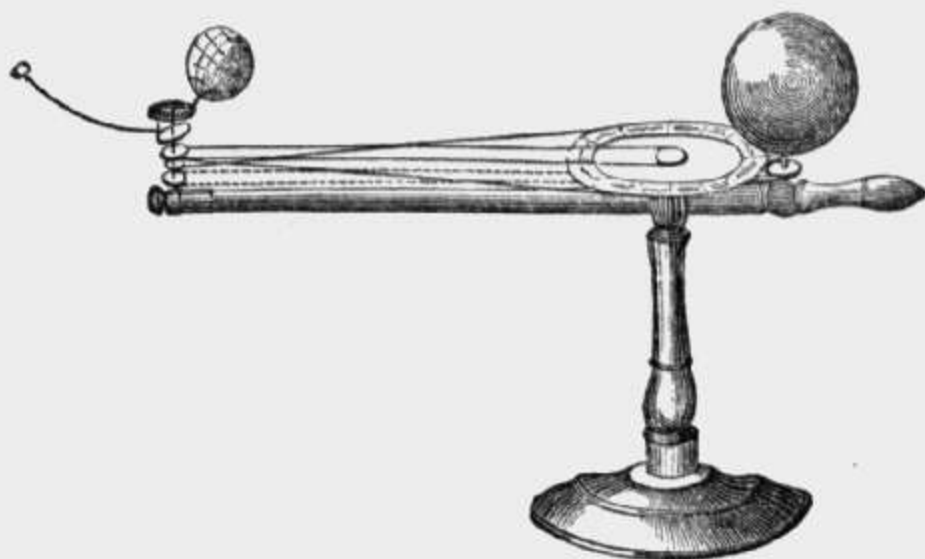

6725.

6725. **Tellurian.** Showing the rotation of the earth about the sun, and of the moon about the earth, the cause of eclipses, etc. Mahogany base and arm..... 15 00

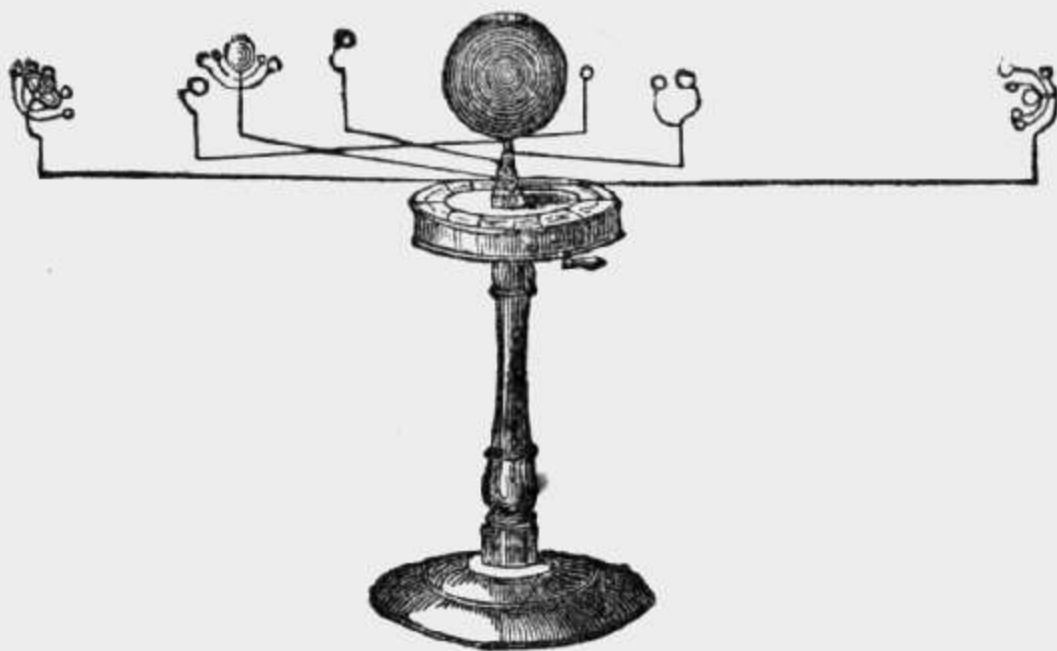

6726.

6726. **Planetarium with Brass Gearing.** Mounted on a neatly finished brass stand. The motion of the various planets around the sun is produced by a crank working upon cog-wheels connected with the bearings of the several planets..... 20 00
6727. **Planetarium, Large Model.** Containing all the planets (excepting the asteroids) yet discovered. On fine polished brass stand, every part of the instrument carefully finished..... 60 00

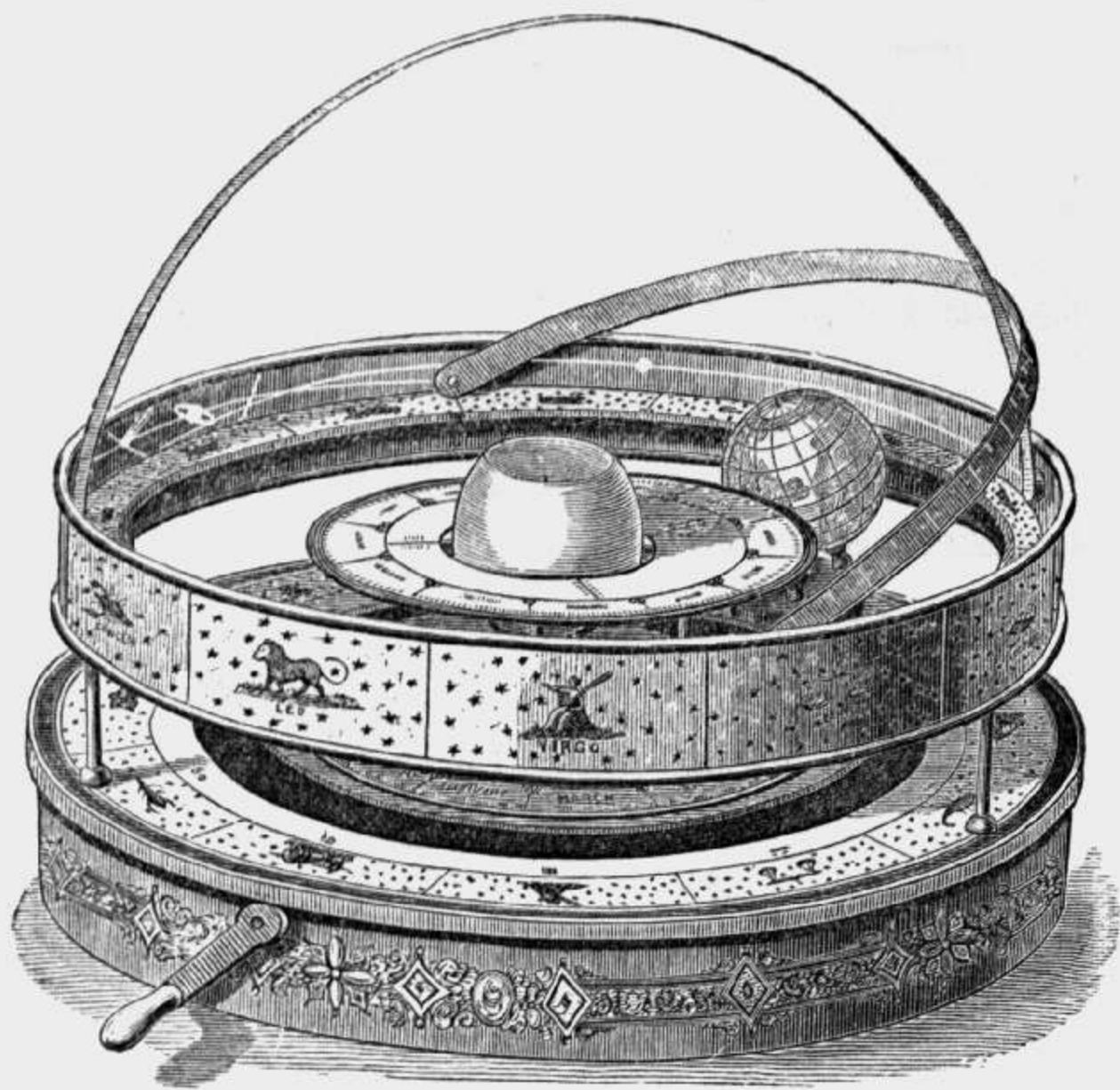

6730-31.

	PRICE
6730. <b>Stellar Tellurian.</b> The most complete of the many instruments devised for the exact illustration of astronomical phenomena. So far as is practicable, every movement represented is as in nature. Thus the earth revolves upon its axis 365 times during a revolution around the sun, the moon performs its 13 + sidereal and 12 + synodic revolutions, etc., etc. Base eighteen inches in diameter...	\$75 00
Boxing.....	2 00
6731. <b>Stellar Tellurian.</b> Same as No. 6730, but base thirty six-inches in diameter.....	115 00
Boxing.....	3 00
<i>A full description of these instruments, showing the construction, mode of working, etc., sent on application.</i>	
6732. <b>Whitall's Planisphere.</b> Showing the stars and constellations visible at any hour in the evening, for every night in the year. The most simple and satisfactory map of the heavens for the use of students and others extant. On strong card-board. 15 inches in diameter. Plain.....	3 00
6733. Same as 6732. Colored.....	3 50
6734. <b>Whitall's Planisphere.</b> On glass for projection in lantern.....	10 00



## CHAPTER X.

## ANATOMICAL MODELS.

## SECTION I.—AUZOUX'S MODELS OF THE ANIMAL KINGDOM.

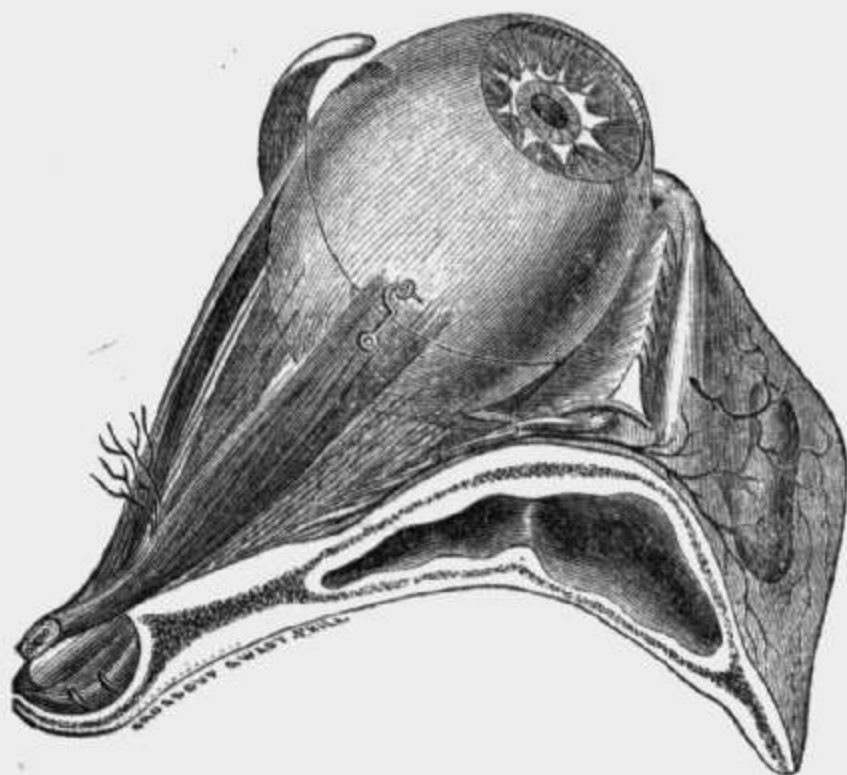

6761.

- |   | PRICE     |
|---|-----------|
| 6750. <b>Complete Model of Man.</b> Six feet high. Showing the muscles, blood-vessels, nerves, and the viscera; so arranged that they can be separately detached and examined. Two thousand distinct objects are shown in their proper position in the human frame. Sufficient to illustrate the most complete treatise on descriptive anatomy.....   | \$1500 00 |
| 6751. <b>Complete Model of Man.</b> Similar in all its details to No. 6750, but smaller, being only four feet high.....   | 500 00    |
| 6752. <b>Incomplete Model of Man.</b> Six feet high. Representing on one side the muscles, etc., of the superficial coats; on the other side the muscles, blood-vessels, and nerves of the deeper tissues; in other respects similar to the complete models, Nos. 6750 and 6751.....  | 500 00    |
| 6753. <b>Incomplete Model of Man.</b> Similar to No. 6752, but only four feet high.....   | 250 00    |
| 6754. <b>Model of Woman,</b> in the attitude and of the size of the <i>Venus de Medici</i> . Showing the muscles and tissues of the superficial coatings, and, on removing the front walls of the trunk, disclosing the various organs which fill the thoracic and abdominal cavities, their nerves, blood-vessels, and all the viscera. Each of these can be removed from its place and examined separately, as in an ordinary dissection..... | 500 00    |
| 6755. <b>Ovology.</b> Development of the germ in the mammals. Collection of more than twenty pieces, reproduced with great enlargement; showing the formation of the ovule in the ovary, its passage into the womb and its fecundation; permitting the changes to be followed at almost daily intervals from the first to the thirtieth day, that is, from the appearance of the ovule in the ovary until the formation of the embryo.....      | 100 00    |

	PRICE
6756. <b>Egg of the Epiornis.</b> Natural size. Four sections permit the study of the various changes from the fresh egg to the complete development of the germ.....	\$50 00
6757. <b>Cerebrum, Cerebellum, Annular Protuberance and Spinal Bulb,</b> showing the details of the nervous system of man and the other vertebrata. ....	75 00
6758. <b>Cerebellum and Spinal Cord</b> in its whole length, with the origin of the spinal nerves, and the anterior and posterior ganglia.....	25 00
6759. <b>Dura Mater.</b> With a portion of the base of the skull, once and a half natural size, showing the whole extent, folds, sinuses, and the glands of Pachioni, etc.....	40 00
6760. <b>Adult Heart.</b> Divided into two halves, showing the disposition of the cavities, the muscular fibres, the arteries, nerves, the valves and the openings of the blood-vessels.....	25 00
6761. <b>Complete Eye.</b> Four inches in diameter, showing the muscles, blood-vessels, nerves, membranes, vitreous and crystalline humors, each part detachable at pleasure. Showing also the results of the most modern microscopic research upon the retina, the choroid coat and the iris.....	40 00
6762. <b>Complete Eye.</b> Cut vertically, with a portion of the orbit, showing the muscles, blood-vessels, nerves, membranes, humors, disposition of the anterior and posterior chambers, the conjunctiva, the structure of the eyelids, of the Meibomian glands, the tear glands and conduits, etc., as well as the microscopic results on the retina, etc.	40 00
6763. <b>Ear.</b> Sixteen inches across, showing the whole intricate detail of both the external and internal ear. Each piece detachable.....	50 00
6764. <b>Ear of a bird.</b> Greatly enlarged.....	25 00
6765. <b>Ear of a fish.</b> Greatly enlarged.....	25 00
6766. <b>Half Head.</b> Of large size, showing in all their delicate details the parts at the base of the brain, the divisions and ramifications of the fifth and seventh pair of nerves, the nervous ganglia, the eye, the ear, the nasal cavities, the mouth, the tongue, the pharynx and the larynx, with their muscles and blood-vessels.....	125 00
6767. <b>Larynx.</b> Once and a half natural size, showing the cartilages, muscles, blood-vessels and nerves.....	7 50
6768. <b>Larynx.</b> Same as preceding, but showing in addition, the tracheal artery and the division of the bronchiæ, to their last ramifications on entering the lung.....	15 00
6769. <b>Human Hand.</b> Once and a half natural size, with the muscles, tendons, blood-vessels, nerves, the corpuscles of Pacini, and a portion of the skin, with its different layers.....	75 00
6770. <b>Gorilla Troglodytes.</b> Five feet in height, showing the whole details separable, of its complete anatomy; viz., the bones, muscles, blood-vessels, nerves and viscera. Arranged just as in the complete model of man, No. 6750.....	1500 00
6771. <b>Complete Horse.</b> Arab type. About four feet high. Complete anatomy, showing more than 3,000 details, in 97 separate pieces. Showing on one side, the muscles, nerves, and blood-vessels, of the superficial coats, which are not movable; on the other, the muscles, nerves, and blood-vessels, removable as in dissection, from the skin to the skeleton. In the cavity of the body are all the organs and viscera with which it is filled. These are removable at will.....	2000 00
6772. <b>Incomplete Horse.</b> Showing on one side the muscles, nerves, and blood-vessels of the outer coatings; on the other, the muscles, nerves, and blood-vessels of the deep coatings only. The organs, etc., of the cavity, complete and removable, as in No. 6771.....	1000 00
6773. <b>Jaws of the Horse.</b> Showing the age, at the different epochs of life. Collection of 30 different types.....	100 00



	PRICE
6774. <b>Jaws of the Ox.</b> Showing the age at the different epochs of life. Collection of 14 different types.....	\$50 00
6776. <b>Foot of the Horse.</b> Showing the hoof, the podophyllous tissue, and the cushion, with the blood-vessels, nerves, etc. Parts separable.	25 00
6777. <b>The Turkey.</b> Type of Birds. Complete anatomy, showing the respiratory apparatus, and the air-sacs of Dr. Sappey.....	150 00
6778. <b>Boa Constrictor.</b> Type of Reptiles, seven feet long. Complete anatomy.....	150 00
6779. <b>Head of Viper.</b> Much enlarged. Showing the fangs, muscles, glands, etc., of the poison apparatus.....	50 00
6780. <b>Sea-Perch.</b> Five and a half feet long. Type of fishes. Complete anatomy, showing muscles, nerves, blood-vessels, viscera, etc.....	250 00
6781. <b>Cockchafer.</b> ( <i>Melolontha vulgaris</i> .) Type of insects in their perfect state. Twelve times natural size. Showing the muscles, tracheæ, nerves, and viscera. Each organ removable separately. The whole shows more than 600 details, indicated by numbers. Complete anatomy.....	125 00
6782. <b>Snail.</b> <i>Helix Pomatia</i> (Linn.). Type of mollusca, two feet long, showing the muscles, blood-vessels, nerves, and viscera. Each organ removable separately. Complete anatomy.....	125 00
6783. <b>Leech.</b> ( <i>Hirudo Medicinalis</i> .) Type of Annelidæ, nearly two feet long. Showing the vascular, nervous, digestive, reproductive, and locomotive apparatus. Anatomy complete, and revised according to the latest researches.....	100 00
6784. <b>Silk-Worm.</b> Type of insect in the larva state. About two and a half feet long. Complete anatomy, showing the muscles, nerves, trachea, viscera, and the organ for the production of the silk.....	125 00
6785. <b>Honey-Bee.</b> Three and a quarter inches long, six different forms. Queen, drone, wax-worker, working bee, with bee bread and with pollen. These have all the exterior and interior characteristics of each type shown. Honey-comb, in same proportions, showing the cells for the honey, the pollen, the eggs for queens, for drones, and for working bees, with the eggs, larvæ, and nymphs of different age	100 00

#### COMPARATIVE ANATOMY.

6786. <b>Comparative Anatomy.</b> A series of organs from man to the zoöphyte show the variation throughout the whole animal kingdom. Consisting of the organs of digestion, of respiration, of circulation, and of innervation in the mammals, birds, reptiles, fishes, insects, and molluscs. All greatly enlarged. Whole set.....	500 00
--	--------

Separate parts of the collection No. 6786.

##### 1. DIGESTION.

6787. <b>Stomach of the Lion</b> .....	15 00
6788. <b>Stomach of the Ruminant</b> .....	40 00
6789. <b>Stomach of the Horse</b> .....	17 50
6790. <b>Stomach of the Rodent</b> .....	15 00
6791. <b>Stomach of a grain-eating Bird</b> .....	10 00
6792. <b>Stomach of a Carnivorous Bird</b> .....	2 50
6793. <b>Stomach and Intestine of the Cuttle-fish</b> .....	15 00
6794. <b>Stomach and intestine of the Crab</b> .....	15 00
6795. <b>Stomach and intestine of a Polyp</b> .....	15 00
6796. <b>Stomach and intestine of a Grasshopper</b> .....	15 00
6797. <b>Stomach and intestine of the Honey-bee</b> .....	10 00

## 2. CIRCULATION.

	PRICE
6798. <b>Heart and Blood-vessels of Human Fœtus</b> .....	\$25 00
6799. <b>Heart and blood-vessels of Crocodile</b> .....	20 00
6800. <b>Heart and blood-vessels of Serpent</b> .....	15 00
6801. <b>Heart and blood-vessels of Tortoise</b> .....	20 00
6802. <b>Heart and blood-vessels of Dugong</b> .....	20 00
6803. <b>Heart and Gills of the Carp</b> .....	20 00
6804. <b>Heart and Blood-vessels of the Oyster</b> .....	5 00
6805. <b>Heart and blood-vessels of the Gasteropods</b> .....	12 50
6806. <b>Heart and blood-vessels of the Cuttle-fish</b> .....	12 50
6807. <b>Heart and blood-vessels of the Muscle</b> .....	10 00
6808. <b>Heart and Trachea of Insect</b> .....	20 00

## 3. NERVES.

6809. <b>Brain and Spinal Cord of Man</b> .....	75 00
6810. <b>Brain of the Cat</b> .....	25 00
6811. <b>Brain of the Rat</b> .....	15 00
6812. <b>Brain of the Goose</b> .....	15 00
6813. <b>Brain of the Viper</b> .....	10 00
6814. <b>Brain of the Tortoise</b> .....	10 00
6815. <b>Brain of the Carp</b> .....	10 00
6816. <b>Brain of the Ray</b> .....	10 00
6817. <b>Nerve System of the mollusca</b> .....	2 50
6818. <b>Nerve system of the radiata</b> .....	2 50
6819. <b>Nerve system of the arachnidæ</b> .....	2 50
6820. <b>Nerve system of the crab</b> .....	2 50
6821. <b>Nerve system of the articulata, in the state of larva, of chrysalis and perfect insect</b> .....	7 50

## 4. RESPIRATION.

6822. <b>Of Birds. Showing larynx, tracheal artery and lungs, with the air sacs</b> .....	25 00
6823. <b>Of Reptiles, lungs of the frog</b> .....	20 00
6824. <b>Of Insects, trachea and heart</b> .....	20 00

## 5. CRANIOLOGY.

6825. <b>Human Head of an Idiot</b> { Skull...\$15 00 } { Brain... 15 00 } .....	30 00
6826. <b>Human Head, excessively large</b> . { Skull...\$30 00 } { Brain... 30 00 } .....	60 00
6827. <b>Head of Young Gorilla</b> . { Skull as yet without bony ridges.\$25 00 } { Brain..... 15 00 } .....	40 00
6828. <b>Head of Adult Gorilla</b> { Skull with commencement of bony ridges.....\$25 00 } { Brain..... 15 00 } .....	40 00
6829. <b>Head of Old Gorilla</b> { Skull with bony ridges, very strongly marked.....\$25 00 } { Brain..... 15 00 } .....	40 00
6830. <b>Head of Female Gorilla, Young</b> { Skull without ridges..\$25 00 } { Brain..... 15 00 } .....	40 00
6831. <b>Head of Female Gorilla, Old</b> { Skull without ridges..\$25 00 } { Brain..... 15 00 } .....	40 00
6832. <b>Head of Chimpanzee</b> { Skull..\$25 00 } { Brain.. 15 00 } .....	40 00
6833. <b>Head of the Orang-Outang</b> { Skull...\$25 00 } { Brain... 15 00 } .....	40 00



	PRICE
6834. Head of the <b>Gibbon</b> . { Skull..\$15 00 } { Brain.. 15 00 } .....	\$30 00
6835. Head of the <b>Seal</b> . { Skull..\$15 00 } { Brain.. 15 00 } .....	30 00
6836. Head of the <b>Lion</b> . { Skull..\$25 00 } { Brain.. 15 00 } .....	40 00
6837. Head of the <b>Panther</b> .....	15 00
6838. Head of the <b>Deer</b> .....	15 00
6839. Head of the <b>Wolf</b> .....	15 00
6840. Head of the <b>Horse</b> .....	30 00
6841. Skull of the <b>Elephant</b> . Dividing into two parts, with jaws and tusks, and showing the numerous cellules which limit the cerebral cavity.	150 00
6842. Brain of the <b>Elephant</b> . Parts so made as to show the internal struc- ture, and to be placed in their proper cavities in the skull, No. 6841.	50 00
6843. Head of the <b>Kangaroo</b> . { Skull. \$10 00 } { Brain.. 10 00 } .....	20 00
6844. Head of the <b>Sea-Hog</b> . { Skull..\$25 00 } { Brain. 15 00 } .....	40 00
6845. Head of the <b>Crocodile</b> . { Head..\$17 50 } { Brain.. 7 50 } .....	25 00

## SECTION II.—ANATOMY OF THE VEGETABLE KINGDOM.

These models are all made ten times the natural size of the object they represent. Each part can be taken off separately, and thus allows a careful and detailed examination of the sepal, the petal, the stamen, the anther, the carpel, the ovule, etc., in the different phases of flowering, growth, and germination.

6850. <b>Wall Flower</b> ( <i>Cheiranthus cheiri</i> ). Stem, leaves, and flowers of different degrees of development, complete flower and fruit in state of maturity, showing the two carpels.....	\$50 00
6851. Flower alone.....	25 00
6852. <b>Silique</b> .....	15 00
6853. <b>Pink</b> ( <i>Dianthus caryophyllus</i> ). Stem, leaves, stipule, bracts, with per- fect flower and mature fruit.....	50 00
6854. Flower alone.....	25 00
6855. <b>Fruit</b> .....	15 00
6856. <b>Pea</b> ( <i>Pisum sativum</i> ). Stem, leaves, stipules, tendrils, flowers, before and after flowering.....	50 00
6857. Flower alone.....	25 00
6858. <b>Pod</b> greatly enlarged. Showing the structure of the carpellary leaves, with a series of ovules, in different stages of growth.....	15 00
6859. <b>Pod</b> Approaching Maturity. Showing the pea, the envelopes, the dico- tyledonous mass, and the embryo.....	15 00
6860. <b>Hare-Bell</b> ( <i>Campanula ranunculus</i> ). Complete flower.....	25 00
6861. <b>Snap-Dragon</b> ( <i>Antirrhinum majus</i> ). Stem, stipules, flowers, before and during flowering, ovary in mature state, dehiscent.....	50 00
6862. Flower alone.....	25 00
6863. <b>Fruit</b> .....	15 00
6864. <b>Chrysanthemum</b> ( <i>Chrysanthemum coronarium</i> ). Stem, leaves, flow- ers, before and during flowering, capable of division into two mass- es, and receptacle with seeds.....	50 00

ANATOMICAL MODELS.

143

	PRICE
6865. <b>Chrysanthemum.</b> Flower alone.....	\$25 00
6866. Receptacle with seeds.....	15 00
6867. <b>Sorrel</b> ( <i>Rumex patientia</i> ). Flower alone, with bracts, calyx, stamen, pistil and ovary.....	15 00
6868. <b>Sorrel.</b> Ripe seed, with dicotyledonous mass in which one may see the embryo.....	10 00
6869. <b>Bittersweet</b> ( <i>Solanum dulcamara</i> ). Complete flower.....	25 00
6870. <b>Deadly Night-Shade</b> ( <i>Atropa belladonna</i> ). Complete flower.....	20 00
6871. <b>Deadly Night-shade.</b> Ripe fruit, with calyx cut transversely to show the disposition of the carpellary leaves and seeds.....	20 00
6872. <b>Henbane</b> , ( <i>Hyoscyamus niger</i> ). Fruit separable into calyx and capsule, and showing by sections the mode of opening, when ripe....	25 00
6873. <b>Fuchsia.</b> Stem, leaves, flowers, before and during inflorescence; a complete flower and a berry, permitting an inspection of the carpellary leaves, and the fruit.....	50 00
6874. Flower alone.....	25 00
6875. <b>Berry</b> .....	10 00
6876. <b>Columbine</b> ( <i>Aquilegia vulgaris</i> ). Fruit whose carpels can be detached, showing the attachment of the seed to the placentæ.....	25 00
6877. <b>Fruit of the Yew</b> ( <i>Taxus baccata</i> ). Opening to show the ovule.....	10 00
6878. <b>Grain of Wheat.</b> Thirty times the natural size, consisting of its husks, the embryonic coat, the farinaceous mass, the embryo and its parts, which one can take out and replace by another embryo, beginning to develop by germination, showing the constituents of the young plant.....	25 00
6879. <b>Acorn.</b> With its capsule, envelopes, the dicotyledonous mass and the embryo.....	25 00
6880. <b>Acorn.</b> Without its envelopes, showing the two cotyledons opening and disclosing the embryo, so far progressed in germination as to have its little leaves and its root and rootlets.....	15 00
6881. <b>Acorn, ripe.</b> Showing the different coats of the pericarp, and the ovule with its envelopes.....	20 00
6882. <b>Wood.</b> Fragment of the woody stem of a dicotyledon ( <i>quercus communis</i> ), of three years' growth, greatly enlarged, showing, in the solid wood, the pith, the spiral vessels, the medullary sheath, the medullary rays, the composition of the woody fibres, the vascular, annular and dotted ducts, the open spaces, the heart wood and sap wood, and the cambium layer; in the bark, the liber, the cellular envelope, and the epidermis, which are each removable; and the sap vessels and wood fibre.....	40 00
6883. <b>Strawberry.</b> Cut vertically to show the development of the receptacle, holding in its parenchyma the numerous seeds or akenes.....	15 00
6884. <b>Mulberry</b> ( <i>Morus nigra</i> ). Cut vertically, showing several simple seeds surrounded with floral envelopes becoming succulent.....	15 00
6885. <b>Comfrey</b> ( <i>Symphytum officinale</i> ). Complete flower.....	20 00
6886. <b>Melon</b> ( <i>Cucumis melo</i> ). Male flower complete.....	15 00
6887. <b>Melon.</b> Female flower complete, with sections made in the ovary, to show the disposition of the carpels and ovules.....	20 00
6888. <b>Moss.</b> Flower of the common.....	25 00
6889. Collection of thirty pieces of flowers and fruits, with woody fibre, No. 6882.....	500 00



## SECTION III.—BOCK-STEGER'S ANATOMICAL MODELS.

These models are of very moderate price, and great excellence of workmanship and design.

	PRICE
6900. <b>Human Heart.</b> Enlarged size; the anterior wall is removable, thus disclosing the cavities and valves.....	\$8 00
6901. <b>Human Eyeball,</b> Enlarged Size. Can be taken to pieces, and then shows the cornea, iris, crystalline lens, vitreous humor, and the coatings, including the results of microscopic examination upon the retina.....	6 50
6902. <b>Human Ear.</b> Enlarged size, containing in separate parts the membrana tympani, the bones of the inner ear, the labyrinth, etc., etc..	8 00
6903. <b>Human Skin.</b> Enlarged, transverse section, showing the perspiratory ducts, the hair and its follicles, sebaceous glands, etc., etc.....	4 00
6904. <b>Human Teeth.</b> Enlarged size, the anterior portion of the left maxillary bone is removed to show their development and structure...	4 00
The following are all of natural size :	
6910. <b>Human Brain.</b> Upper portion.....	3 50
6911. <b>Human Brain.</b> Lower portion.....	3 50
6912. <b>Human Brain.</b> Perpendicular section along the median line.....	3 50
6913. <b>Human Brain.</b> Transverse section, showing the cavities.....	3 50
6914. <b>Human Head,</b> with muscles, nerves and blood-vessels of one side....	6 00
6915. <b>Human Head,</b> with the cavities of the skull and eye, upper and lower jaw.....	6 00
6916. <b>Human Head,</b> Perpendicular section along the median line, showing the brain, the cavities of the nose and mouth, larynx and pharynx.	6 00
6917. <b>Human Lungs and Heart.</b> Anterior view, showing the pericardium opened, the anterior portion of the left lung removed, and the ramifications of the bronchiæ.....	4 00
6918. <b>Human Lungs and Heart.</b> Posterior view.....	4 00
6919. <b>Organs of Respiration.</b> Air-passages, Lungs, Heart. Anterior portion of both lungs and heart removable, showing the ramifications of the bronchiæ, and the connection of the pulmonary blood-vessels with the heart.....	12 00
6920. <b>The Larynx.</b> Anterior view.....	2 50
6921. <b>The Larynx.</b> Posterior view.....	2 50
6922. <b>Larynx, Tongue and Pharynx,</b> the latter opened from behind.....	3 50
6923. <b>Shoulder-joint,</b> opened, with bones and ligaments.....	2 50
6924. <b>Elbow-joint.</b> Anterior view....	2 00
6925. <b>Elbow-joint.</b> Lateral view.....	2 00
6926. <b>Wrist-joint and Hand.</b> .....	3 00
6927. <b>Hip-joint.</b> .....	2 50
6928. <b>Knee-joint</b> .....	2 50
6929. <b>Ankle-joint and Foot</b> .....	4 00
6930. Complete set of the foregoing 25 models, securely packed, ready for shipment.....	110 00
6931. <b>The Trunk.</b> With the viscera of the chest and abdomen.....	30 00
6932. <b>Skull and Brains.</b> Completely separable.....	12 00
6933. <b>Larynx Model.</b> With mask and mouth open for practice in laryngoscopy.....	10 00
6934. <b>Perrin's Ophthalmoscopic Eye.</b> .....	27 50

CHAPTER XI.

CHEMICAL APPARATUS.

1. TROEMNER'S BALANCES AND SCALES.

*In use at all the United States Mints, at the United States Treasury, and the Naval and Hospital Departments.*

ANALYTICAL BALANCES.

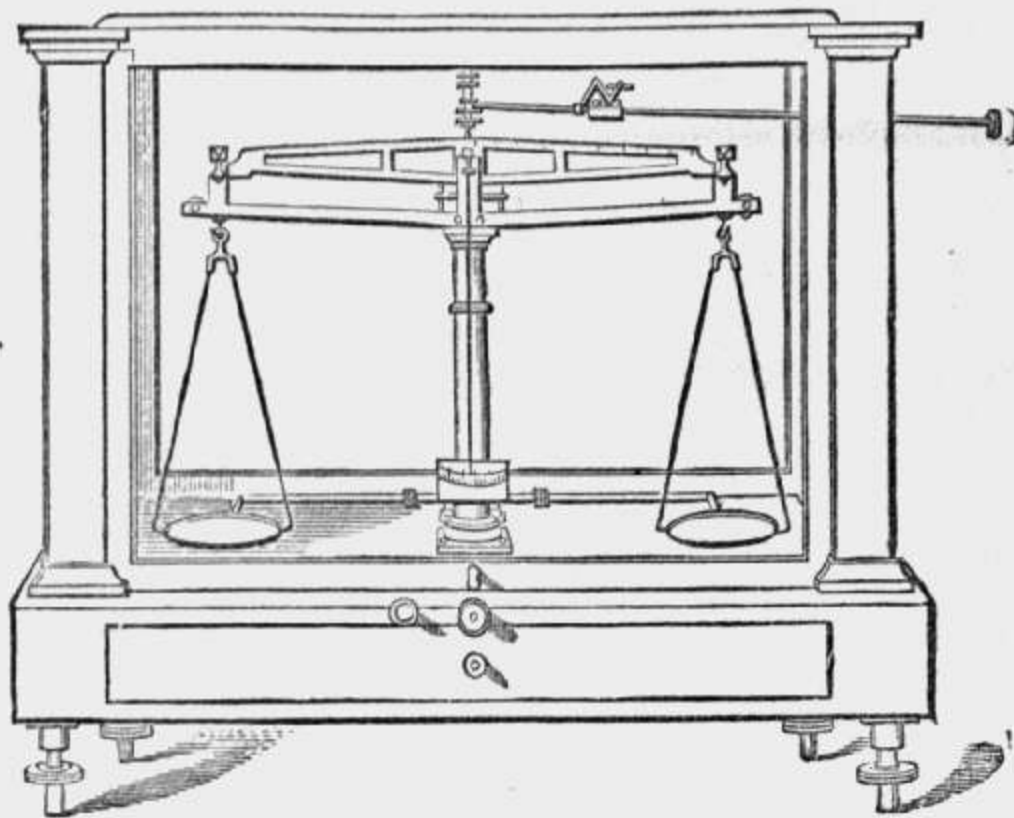

6975.

- |   | PRICE    |
|---|----------|
| 6975. Analytical Balance, capacity 200 grammes in each pan, in fine polished glass case; beam divided in 1-10 milligrammes; sensible to 1-20 milligrammes; all agate bearings, with improved arrest for pans, and apparatus for specific gravity, &c., &c. Three inch pans. Beam 14 inches..... | \$105 00 |
| 6976. Analytical Balance, in fine polished glass case, capacity 100 grammes in each pan; beam divided in half parts of milligrammes; sensible to 1-10 milligrammes; with apparatus for specific gravity, all bearings agate. 2½ inch pans. 12 inch beam.....                                    | 86 00    |
| 6977. Analytical Balance, in fine polished glass case, capacity 2000 grains; sensible to 1-20 grain; fine steel bearings; movable 3½ inch pans; 10 inch beam.....   | 40 00    |

ANALYTICAL SCALES.

For weighing Ores, Minerals, Gold and Silver Coin. Jewelry, Chemicals, &c., &c.

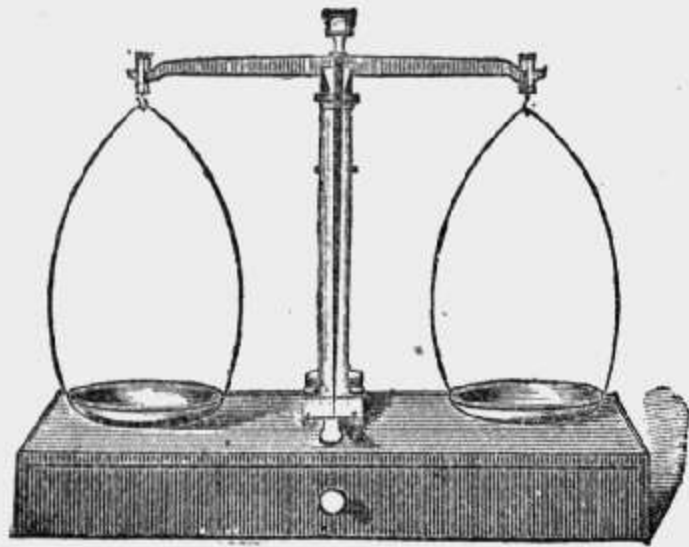

6978-80.

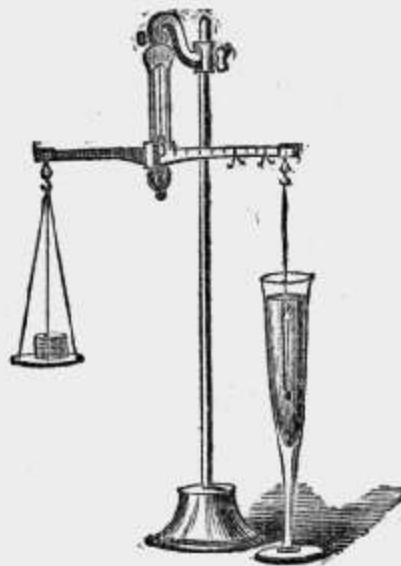

6981.



**Analytical Scales.**—On fine polished box, with spirit-level and adjusting screws, improved drop lever, ivory indicator, and sensible to 1-10 grain.

No.	Length of Beam.	Diameter of Pan.	Capacity.	PRICE
6978.	14 in.	5½ in.	25 oz.....	\$26 00
6979.	10 "	5 "	16 " .....	18 00
6980.	8½ "	3 "	8 " .....	15 00

Pans can be suspended by chains if desired.

6981.	<b>Specific Gravity Scale.</b> Constructed after the plan of Dr. Mohr. Price, complete.....	20 00
-------	--	-------

## 2. APPARATUS FOR THE MANUFACTURE OF GASES, &C.

7000.	<b>Apparatus for the manufacture of Oxygen from the chlorate of potash and binoxide of manganese.</b> Consisting of a copper bottle of over a quart capacity, with lead pipe of large calibre, fitted to it by a ground joint (thus dispensing with the objectionable gallews screw arrangement); and passing at the other end by a screw coupling to a strong wash bottle, for washing. Six feet of rubber tubing, with connector, lead the gas from the wash bottle. Complete ...	12 50
7001.	<b>Copper Retort of No. 7000.</b> .....	4 50
7002.	<b>Copper Retort and Lead Pipe of No. 7000.</b> .....	6 00
7003.	<b>Wash Bottle of No. 7000.</b> .....	4 00
7004.	<b>Apparatus for the manufacture of Oxygen from the chlorate of potash.</b> Consisting of a strong iron basin-shaped vessel, holding a gallon or more, with feeding arrangement cover, and iron exit pipe 1½ inch in diameter. For the manufacture of large quantities of gas.....	25 00
7006.	<b>Apparatus for the manufacture of Hydrogen.</b> Glass jar, holding one gallon, with top, inverted bell, support for zinc and stop-cock.....	7 00
7007.	<b>Dobereiner's Lamp.</b> Same as No. 7006, but with the addition of a jet and holder for platinum sponge, with sponge.....	9 00
7008.	<b>Dobereiner's Lamp.</b> Small model.....	5 00
7009.	<b>Attachment to No. 7006, for the production of musical sound.</b> Consisting of a brass jet 11 inches long, and three tubes of different length.....	2 50
7010.	<b>Apparatus for the manufacture of Hydrogen.</b> Consisting of a copper tank with floating cistern seven inches in diameter and thirteen inches deep, with false bottom to hold the zinc. Copper exit pipe leading to a strong wash-bottle. Without wash-bottle.....	20 00
7011.	<b>With wash-bottle.</b> .....	24 00
7012.	<b>Automatic Apparatus for the manufacture of Hydrogen in large quantities.</b> Consisting of a heavy copper tank with handles, a floating cistern of copper eleven inches in diameter and twenty-six inches deep, with false bottom to hold the zinc. Sponge-absorber, and copper exit pipe leading to a strong wash-bottle. Without wash-bottle.	40 00
7013.	<b>No. 7012, with wash-bottle.</b> .....	44 00
7018.	<b>India-Rubber Bag, oval, best quality, for storing oxygen or hydrogen, with stop-cock, 1 gallon.</b> .....	3 50
7019.	<b>India-Rubber Bag, oval, best quality, for storing oxygen or hydrogen, with stop-cock, 2 gallons.</b> .....	4 50
7020.	<b>India-Rubber Bag, oval, best quality, for storing oxygen or hydrogen, with stop-cock, 3 gallons.</b> .....	5 50

CHEMICAL APPARATUS.

147

	PRICE
7021. India-Rubber Bag, oval, best quality, for storing oxygen or hydrogen, with stop-cock, 5 gallons.....	\$6 50
7022. India-Rubber Bag, oval, best quality, for storing oxygen or hydrogen, with stop-cock, 6 gallons.....	7 50
7023. India-Rubber Bag, oval, best quality, for storing oxygen or hydrogen, with stop-cock, 8 gallons.....	9 50
7024. India-Rubber Bag, oval, best quality, for storing oxygen or hydrogen, with stop-cock, 10 gallons.....	11 50
7025. Mouth-piece attachment.....	75
7026. Bubble-tube attachment.....	1 00
7028. <b>India-Rubber Bag</b> , 24 inches by 30, with stop-cock.....	13 00
7029. India-Rubber Bag, 30 inches by 40, with stop-cock.....	16 00
7030. India-Rubber Bag, 30 inches by 40, very superior, with stop-cock....	25 00
7031. <b>Hydrogen Balloons</b> of French rubber. Each.....	50
7032. Hydrogen Balloons of French rubber, large size. Each.....	1 50
7033. Hydrogen Balloons of Gold-beaters' skin. Each.....	2 50
7034. Hydrogen Balloons of Collodion. Each.....	1 00
7040. <b>Gasometers.</b> Pair of copper, neatly japanned, with floating bells 10 inches by 30. Mounted on base with castors, with the balance-weights enclosed in tubes at each side.....	115 00
7041. Gasometers. Pair of galvanized iron, on strong oak frame, with guides, balance weights, and outlet stop-cock. The floating bells are 30 inches in diameter by 40 inches high, and the top is strengthened by a wooden cover to allow of adding weights if desired, and is also surmounted by a cylindrical extension to contain sand in the absence of weights. Per pair.....	125 00
7042. Gasometer. Similar to those in No. 7041, but 36 inches in diameter by 72 inches high, for storing large quantities of gas. Each.....	100 00
7043. <b>Hydro-oxygen Blow-Pipe.</b> For deflagrating metals. Very strongly made, and substantially mounted.....	20 00

3. MISCELLANEOUS CHEMICAL APPARATUS.

7044. <b>Phosphorus Cup.</b> On stand to place under receiver in obtaining nitrogen.....	2 00
7045. <b>Eudiometer.</b> Bunsen's.....	3 50
7046. Eudiometer. Ure's, straight.....	2 00
7047. Eudiometer. Ure's, U form.....	3 50
7048. Eudiometer. Hoffmann's, V form on stand.....	7 00
7049. Eudiometer. Hoffmann's, V form on stand, large model.....	15 00
7050. <b>Atomizing Tubes.</b> Each.....	25
7051. <b>Arsenical Test Apparatus.</b> Marsh's. Complete and mounted.....	4 25
7052. Arsenical Test Apparatus. Fresenius'.....	5 00
7053. Arsenical Test Apparatus. Mitscherlich's.....	3 00
7054. <b>Apparatus</b> for the Manufacture of Carbonic Acid. Consisting of a gallon receiver with closed top, containing an inverted bell-glass, and lead dish, and furnished with stop-cock.....	7 00
7055. <b>Morton's Apparatus</b> for Monochromatic Light. Complete.....	12 00
7075. <b>Glass Beakers</b> , common form, in nests of 4; up to 4 oz.....	35
7076. Glass Beakers, common form, in nests of 6; up to 16 oz.....	80
7077. Glass Beakers, common form, in nests of 9; up to 48 oz.....	2 00
7078. Glass Beakers, common form, in nests of 12; up to 140 oz.....	4 00
7079. Glass Beakers, tall form, set of 8.....	3 50



	PRICE
7080. <b>Blow-Pipe</b> , jewelers' form.....	\$0 25
7081. Blow-Pipe, with bulb.....	75
7082. Blow-Pipe, Berzelius'... ..	2 00
7083. Blow-Pipe, Plattner's, most perfect form.....	3 00
7084. Blow-Pipe, Berzelius', nickel-plated.....	3 00
7085. Blow-Pipe, Plattner's, nickel-plated .....	4 00
7086. <b>Bolt Heads</b> , pint size.....	75
7087. Bolt Heads, quart size.....	1 25
7088. <b>Liebig's Condenser</b> , of glass, mounted.....	2 00
7089. Liebig's Condenser, of japanned tin.....	4 50
7090. Liebig's Condenser, of brass.....	6 00
7100. <b>Cork-Borers</b> , set of 3 of brass.....	2 00
7101. Cork-Borers, set of 6 of brass.....	3 50
7102. Cork-Borers, set of 12 of brass.....	6 50
7103. <b>Crucibles</b> , Hessian, per nest of 5, from $\frac{1}{8}$ oz. to 8 oz.....	25
7104. Crucibles, Hessian, per nest of 5, from 2 oz. to 1 qt.....	75
7105. Crucibles, Plumbago, 4 oz.....	25
7106. Crucibles, Plumbago, 6 oz.....	30
7107. Crucibles, Plumbago, 8 oz.....	35
7108. Crucibles, Plumbago, 12 oz.....	40
7109. Crucibles, Berlin porcelain with cover, $\frac{1}{4}$ oz.....	25
7110. Crucibles, Berlin porcelain with cover, $1\frac{1}{4}$ oz.....	40
7111. Crucibles, Berlin porcelain with cover, 2 oz.....	50
7112. Crucibles, Berlin porcelain with cover, 4 oz.....	60
7113. Crucibles (Beaufay's), clay free from iron, 2 oz.....	10
7114. Crucibles (Beaufay's), clay free from iron, 4 oz.....	15
7115. Crucibles (Beaufay's), clay free from iron, 6 oz.....	20
7116. Crucibles (Beaufay's), clay free from iron, 12 oz.....	25
7117. <b>Crucible Tongs</b> , large.....	1 75
7118. Crucible Tongs, small, steel.....	1 25
7130. <b>Deflagrating Spoons</b> , 14 inches long.....	25
7131. Deflagrating Spoons, 20 inches long.....	40
7132. <b>Drying Oven</b> , with Kemp's regulator.....	11 00
7133. <b>Dropping Tubes</b> , each.....	25
7140. <b>Eolipile of Glass</b> , for ether.....	25
7141. <b>Evaporating Dishes</b> , of royal Berlin porcelain, holding 2 oz.....	25
7142. Evaporating Dishes, same as No. 7141, but holding 3 oz.....	30
7143. Evaporating Dishes, same as No. 7141, but holding 4 oz.....	35
7144. Evaporating Dishes, same as No. 7141, but holding 6 oz.....	40
7145. Evaporating Dishes, same as No. 7141, but holding 8 oz.....	45
7146. Evaporating Dishes, same as No. 7141, but holding a pint.....	80
7147. Evaporating Dishes, same as No. 7141, but holding 2 quarts.....	2 00
7150. <b>Filtering Stands</b> , of hard wood.....	1 00
7151. <b>Filtering Paper</b> , German, per quire.....	65
7152. Filtering Paper, Swedish, per quire.....	1 50
7153. <b>Filtering Apparatus</b> , Bunsen's.....	12 00
7154. <b>Flask</b> . Glass, without lead, round bottom, with strong rim for cork, four ounce.....	25
7155. Flask. Same as 6954, but half pint.....	30
7156. Flask. Same as 6954, but pint.....	40
7157. Flask. Same as 6954, but quart.....	50
7158. <b>Flask</b> . Similar to 7154, but with flat bottom, half pint.....	30
7160. Flask. Same as No. 7158, pint.....	40
7161. Flask. Same as No. 7158, quart.....	50

CHEMICAL APPARATUS.

149

	PRICE
7162. Flask. Same as No. 7158, half gallon .....	\$0 75
7163. Flask. Same as No. 7158, one gallon.....	1 25
7164. Flask. Same as No. 7158, two gallons.....	1 75
7165. Forceps. Strong steel for bending wire, round jaws.....	1 25
7166. Forceps. Strong steel for cutting wire.....	1 25
7167. Forceps. Steel, with platinum points, double form.....	1 50
7168. Funnel. Of glass, ordinary style, four ounce.....	15
7169. Funnel. Of glass, ordinary style, eight ounce.....	18
7170. Funnel. Of glass, ordinary style, pint.....	25
7171. Funnel. Of glass, ordinary style, quart.....	35
7172. Funnel. Of glass, ordinary style, half gallon.....	50
7173. Funnel. Of glass, ordinary style, one gallon.....	75
7174. Funnel. Porcelain ribbed, pint.....	1 25
7175. Funnel. Porcelain ribbed, quart.....	1 75
7176. Funnel. Best Bohemian glass, angle of 60°, stem with parallel sides, for Bunsen's filtering apparatus, two inches diameter.....	20
7177. Funnel. Same. Three inches diameter.....	30
7178. Funnel. Same. Four inches diameter.....	40
7179. Funnel. Same. Five inches diameter.....	50
7180. Funnel. Separating, conical, of best Bohemian glass, with stop-cock ground into the stem, four inches.....	2 50
7181. Funnel. Same. Six inches.....	3 25
7182. Funnel. Same. Eight inches.....	4 50
7183. Funnel Tubes. Plain, glass, conical.....	25
7184. Funnel Tubes. Plain, glass, globular top .....	25
7185. Funnel Tubes. Welter's safety, with one bulb.....	30
7186. Funnel Tubes. Welter's safety, with two bulbs.....	40
7187. Funnel Tubes. Welter's safety, with three bulbs.....	50
7200. Graduate Glasses. English form, with foot and lip, two ounce.....	30
7201. Graduate Glasses. English form, with foot and lip, four ounce.....	45
7202. Graduate Glasses. English form, with foot and lip, eight ounce.....	60
7203. Graduate Glasses. English form, with foot and lip, sixteen ounce... ..	1 00
7204. Graduated Cylinders. On foot, for mixing; 100 cubic centimeters graduated to $\frac{1}{10}$ c. c.....	1 25
7205. Same. 500 cubic centimetres graduated to 5 c. c.....	2 00
7206. Same. 1000 cubic centimeters graduated to 10 c. c.....	4 25
7207. Mohr's Burettes. With spring compressor, 30 c. c. graduated to $\frac{1}{10}$ c. c.....	2 25
7208. Same. 50 c. c. graduated to $\frac{1}{2}$ c. c.....	2 25
7209. Rotating Stand, for ten burettes.....	5 00
7210. Spring Compressor. Of wood.....	15
7211. Spring Compressor. Of brass.....	30
7212. Pipettes. Plain.....	25
7213. Pipettes. Bulbed.....	30
7220. Hydrometers, Beaumé's, for spirits. Each.....	1 00
7221. Hydrometers, for ether. Each.....	1 00
7222. Hydrometers, for sugar. Each.....	1 00
7223. Hydrometers, for milk. Each.....	1 00
7224. Hydrometers, for beer. Each.....	1 00
7225. Hydrometers, for bark liquor. Each.....	1 00
7226. Hydrometers, for wine must. Each.....	1 00
7227. Hydrometers, for coal-oil. Each.....	1 00
7228. Hydrometers, for alkali. Each.....	1 00
7229. Hydrometers, for acid. Each.....	1 00



	PRICE
7230. <b>Hydrometers</b> , for acid, with thermometer. Each.....	\$2 00
7231. Hydrometers, for salt. Each.....	1 00
7232. Hydrometers, pair of Beaumé's, with sp. gravity also marked on the scale, from 1,000 to 800 sp. grav., for heavy, and from 1,000 to 1,933 sp. grav., for light liquids; in a neat case, with thermometer and jar.....	8 00
7233. <b>Hydrometers, Twaddle's</b> , for dyers and calico-printing, Nos. 1, 2, 3, 4, each.....	1 00
7234. <b>Hydrometer. U. S. Revenue</b> , for alcohol, with thermometer.....	5 00
7235. Hydrometer. Same as No. 7034, in neat mahogany case with key, with jar, for floating.....	10 00
7236. <b>Hydrometer Jars</b> , plain.....	1 00
7237. Hydrometer jars, with lip.....	1 25
7238. <b>Urinometer</b> , with sp. gravity scale, plain.....	1 50
7239. Urinometer, with sp. gravity scale, in case, with jar.....	2 50
7240. Urinometer, in morocco case, with graduated glass.....	3 50
7241. Urinometer. Same as No. 7240, but with the addition of thermometer.....	6 00
7242. Urinometer. Fine finish, with thermometer, and bottles for reagents, in neat morocco case, very complete.....	18 00
7243. <b>Picnometer</b> .....	50
7244. Picnometer, with thermometer.....	6 00
7260. <b>Mercury Trough</b> . Of porcelain, holding 5 lbs.....	1 00
7261. Mercury Trough. Of porcelain, holding 16 lbs.....	2 00
7262. <b>Mortars. Glass</b> , with pestle, 3 inches.....	40
7263. Mortars. Glass, with pestle, 5 inches.....	70
7264. Mortars. Glass, with pestle, 6 inches.....	1 00
7265. Mortars. <b>Iron, with pestle</b> , smooth inside, 4 inches across top.....	75
7266. Mortars. Iron, with pestle, 5 inches across top.....	1 15
7267. Mortars. Iron, with pestle, 6 inches across top.....	1 75
7268. Mortars. Iron, with pestle, 7 inches across top.....	2 75
7269. Mortars. Iron, with pestle, 9 inches across top.....	3 50
7270. Mortars. With pestle, <b>best wedgewood</b> , 3 inches across top.....	45
7271. Mortars. With pestle, best wedgewood, 4 inches across top.....	70
7272. Mortars. With pestle, best wedgewood, 4½ inches across top.....	85
7273. Mortars. With pestle, best wedgewood, 5 inches across top.....	1 00
7274. Mortars. With pestle, best wedgewood, 5½ inches across top.....	1 25
7275. Mortars. With pestle, best wedgewood, 6 inches across top.....	1 50
7276. Mortars. With pestle, best wedgewood, 6½ inches across top.....	1 75
7277. Mortars. With pestle, best wedgewood, 7 inches across top.....	2 00
7278. Mortars. With pestle, best wedgewood, 8 inches across top.....	3 25
7279. Mortars. With pestle, best wedgewood, 10 inches across top.....	4 50
7280. Mortars. With pestle, best wedgewood, 12 inches across top.....	7 00
7281. Mortars. With pestle, <b>porcelain, unglazed within</b> , 4 inches diameter.....	75
7282. Mortars. With pestle, porcelain, unglazed within, 4½ inches diameter.....	1 00
7283. Mortars. With pestle, porcelain, unglazed within, 5½ inches diameter.....	1 25
7284. Mortars. With pestle, porcelain, unglazed within, 6 inches diameter.....	1 50
7285. Mortars. With pestle, porcelain, unglazed within, 6½ inches diameter.....	2 00
7286. Mortars. With pestle, porcelain, unglazed within, 7 inches diameter.....	2 25
7287. Mortars. <b>Agate</b> , with pestles of same material, 1½ inch diameter..	2 50
7288. Mortars. Agate, with pestles of same material, 2 inches diameter...	4 00
7289. Mortars. Agate, with pestles of same material, 2½ inches diameter..	6 50
7290. Mortars. Agate, with pestles of same material, 3 inches diameter...	9 00
7300. <b>Ozonometer</b> . Small model.....	10 00
7301. <b>Platinum Wire</b> . No. 36, per yard.....	50
7302. Platinum Wire. No. 30, per yard.....	40



	PRICE
7303. Platinum Wire. No. 24, per grain.....	\$0 03
7304. Platinum Wire. No. 18, ".....	03
7305. Platinum Wire. No. 12, ".....	03
7306. Platinum Foil. Per grain.....	03
7307. Platinum Spoons. Per grain.....	03
7308. Platinum Sponge, best, each.....	75
7309. Pneumatic Trough. Deep form, of neatly japanned tin, with sliding shelf for jar.....	5 00
7310. Pneumatic Trough. Same as No. 7309, but made of strong copper, neatly japanned.....	12 00
Receivers. See Chapter III., Section V.	
7311. Retorts. Best Bohemian glass, plain, 1 ounce.....	20
7312. Retorts. Best Bohemian glass, plain, 2 ounce.....	25
7313. Retorts. Best Bohemian glass, plain, 4 ounce.....	30
7314. Retorts. Best Bohemian glass, plain, 8 ounce.....	40
7315. Retorts. Best Bohemian glass, plain, 16 ounce.....	50
7316. Retorts. Best Bohemian glass, plain, 32 ounce.....	60
7317. Retorts. Best Bohemian glass, plain, 64 ounce.....	90
7318. Retorts. Best Bohemian glass, plain, 2 gallon.....	2 25
7319. Retorts. Best Bohemian glass plain, 4 gallon.....	3 50
7320. Retorts. Best Bohemian glass, tubulated with ground stopper, 2 oz..	35
7321. Retorts. Best Bohemian glass, tubulated with ground stopper, 4 oz..	40
7322. Retorts. Best Bohemian glass, tubulated with ground stopper, 8 oz..	50
7323. Retorts. Best Bohemian glass, tubulated with ground stopper, pint.	60
7324. Retorts. Best Bohemian glass, tubulated with ground stopper, quart.	70
7325. Retorts. Best Bohemian glass, tubulated with ground stopper, $\frac{1}{2}$ gal.	1 20
7326. Retorts. Best Bohemian glass, tubulated with ground stopper, 1 gal.	1 50
7327. Retorts. Best Bohemian glass, tubulated, with ground stopper, 4 gall.	4 50
7328. Retort Stand. Of iron, with three rings, on iron base.....	1 25
7399. Retort Stand. Of wood, with cork shields.....	1 25
7330. Retort Stand. Universal, iron base, wooden arms, very firm and strong.....	4 00
7350. Spatula. Of steel, with handle, blade 3 inches long.....	25
7351. Spatula. Of steel, with handle, blade 5 inches long.....	35
7352. Spatula. Of steel, with handle, blade 6 inches long.....	40
7353. Spatula. Of steel, with handle, blade 8 inches long.....	65
Spirit Lamps. See Chapter VI., Section I.	
Syphons. See Chapter III., Section IV.	
7354. Specie Jars. For collecting gases, very strong, pint.....	25
7355. Specie Jars. For collecting gases, very strong, quart.....	35
7356. Specie Jars. For collecting gases, very strong, $\frac{1}{2}$ gallon.....	60
7357. Specie Jars. For collecting gases, very strong, gallon.....	75
7370. Test Tubes. German glass, free from lead, 3 inches long, per dozen.	30
7371. Test Tubes. German glass, free from lead, 4 inches long, per dozen.	40
7372. Test Tubes. German glass, free from lead, 5 inches long, per dozen.	50
7373. Test Tubes. German glass, free from lead, 6 inches long, per dozen.	60
7374. Test Tubes. German glass, free from lead, 7 inches long, per dozen.	75
7375. Test Tube Racks. White wood, per dozen tubes.....	1 00
7376. Test Tube Racks. Of mahogany, with pins for draining.....	1 00
7390. Woulfe's Bottles. With two necks, $\frac{1}{2}$ pint.....	40
7391. Woulfe's Bottles. With two necks, pint.....	50
6392. Woulfe's Bottles. With three necks, $\frac{1}{2}$ pint.....	65
7393. Woulfe's Bottles. With three necks, pint.....	75
7394. Woulfe's Bottles. With three necks, quart.....	1 00
7395. Watch Glasses. Assorted, per dozen.....	40





# INDEX.

	PAGE		PAGE
Abbe Nollet's Globe.....	85	Barometer in Vacuo.....	35
Absorption Cells.....	120	Barometer Gauge.....	31
Absorption Globe.....	120	Standard.....	29
Acoustic Bellows.....	46	Tube.....	29
Adhesion Disk.....	2	in Vacuo.....	35
Air Pumps.....	30, 31	Barometric Manometer.....	31
Air-Gun Jet.....	39	Battery Cells.....	106
Mill.....	37	Batteries, Electrical.....	83
Shower.....	38	Galvanic.....	86, 87, 88, 89
Syringe.....	64	Beaker Glasses.....	147
Air Thermometer.....	55	Beclard's Endosmeter.....	4
Amalgam.....	86	Becquerel's Apparatus.....	116
Ampere's Frame.....	95	Bell Engine.....	105
Table.....	96	Bell Glasses.....	32
Analytical Balances.....	145	Bell for Vacuum.....	35, 46
Anamorphoscope.....	110	Electrical.....	80
Anatomical Models, Auzoux'.....	138-143	Bellows, Acoustic.....	46
Bock-Steger's.....	144	Bertsch Electrical Machine.....	78
Anorthoscope.....	130	Berzelius Lamp.....	54
Aphlogistic Lamp.....	54	Binding Screws.....	106
Apple-Cutter.....	38	Biot's Hemispheres.....	75
Arago's Induction Apparatus.....	99	Black Glass, Plate of.....	125
Archimedes' Principle.....	21	Bladder Glass.....	33
Pump.....	26	Block of Wood, weighted.....	37
Arragonite, Plate of.....	127	Blowpipes, Mouth.....	148
Arsenical Test Apparatus.....	147	Oxy-Hydrogen.....	147
Astatic Needle.....	74	Bocksteger's Models.....	144
Atomizing Tubes.....	147	Bohnenberger's Apparatus.....	11
Atwood's Machine.....	16	Electroscope.....	87
August's Psychrometer.....	72	Bolt Head.....	35-148
Aurora Tube.....	85	Bottle Imp.....	20
Auzoux' Models.....	138-143	Bottle of Oil.....	41
Babbage and Herschel's Induction Apparatus.....	99	Boutigny's Apparatus.....	68
Babinet's Compensating Prism.....	127	Boxwood Moulds.....	65
Bacchus Illustration.....	35	Bradley's Apparatus for Electric Measurement.....	90
Balance.....	2	Brass Ball.....	84
Analytical.....	145	Chain.....	86
Specific Gravity.....	21, 22, 146	Brewster's Disk.....	113
Coulomb's Torsion.....	74	British Association's Unit.....	90
Nicholson's.....	21	Browning's Electrical Light Regu- lators.....	93
Ball and Ring.....	55	Bubble Tube.....	147
Ball on Handle.....	84	Bucket, Electrical.....	80
Ball Paradox.....	39	Bundle of Glass Plates.....	125
Balloon and Car.....	20	Bunsen's Burners.....	54
Barker's Mill.....	28	Blast Lamp.....	54
Bar Magnet.....	73		



	PAGE		PAGE
Burettes, Mohr's .....	149	Cork Globe .....	33
Burning Mirror .....	61	Coulomb's Torsion Balance .....	74
Bursting Squares .....	38	Electrometer .....	77
Calcium Light Apparatus .....	107	Couplings, Screw .....	41
Calc Spar .....	124, 126, 127	Crucibles .....	148
Camera Boxes .....	122, 123	Tongs .....	148
Candle Bombs .....	69	Culinary Paradox .....	65
Capillary Plates .....	3	Cupping Glass .....	38
Tubes .....	3	Curve of Swiftest Descent .....	15
Carbonic Acid Apparatus .....	147	Cryophorus .....	65
Carbons for Battery .....	106	in Vacuo .....	35
Card-Board Rule .....	1	Crystals, Models of .....	3
Cast-Iron Bottles .....	65	for Polariscopes .....	126, 127
Cathetometer .....	1	Dalton's Apparatus .....	67
Cat's Skin .....	75	Dancing Images .....	81
Centre of Gravity .....	18	Daniel's Hygrometer .....	72
Centrifugal Forces, Apparatus to illustrate .....	8, 9	Davy's Safety Lamp .....	64
Centrifugal Railroad .....	10	Decomposing Water Apparatus .....	94
Chime, Electrical .....	80	Tank, for projection .....	94
Chladni Apparatus .....	46	Deflagrating Spoon .....	148
Plates .....	49	De La Rive's Ring .....	96
Plates, Support for .....	49	Demonstration Lenses .....	112
Chlorophyll .....	121	Density of Water Apparatus .....	55
Chinese Tumblers .....	19	Dial Telegraph .....	97
Chromate of Potash, Plate of .....	127	Diamond Jar .....	81
Chronograph, Regnault's .....	52	Diapasons .....	44
Claque Bois .....	49	Two in unison .....	46, 49, 50
Clarke's Induction Machines .....	100	Interrupters .....	52
Clockwork Electrotome .....	105	with Resonators .....	45
Cohesion Figures .....	3	Dielectric Machine .....	79
Hemispheres .....	2	Differential Manometer .....	40
Plates .....	2	Diffraction Slits .....	124
Coils, Rhumkorff's Induction .....	101, 102	Diffusometer, Graham's .....	4
Coil, Horizontal .....	96	Dipping Needle .....	73
Lifting .....	96	Discharger, Electrical .....	83
Primary and Secondary .....	99	Diving Bell .....	24
Revolving .....	105	Directing Rod .....	79
Collision Balls .....	5	Dobereiner's Lamp .....	146
Plate .....	5	Double Image Prisms, for projec- tion .....	124, 128
Complete Apparatus for .....	5	Double Leyden Jar .....	82
Colored Glasses .....	120	Double Refracting Crystals, etc. .....	124, 125
Comparative Manometer .....	40	Dropping Tubes .....	148
Compensating Pendulum .....	56	Drying Oven .....	148
Compound Bar .....	56	Duboscq's Electric Light Regulator .....	93
Compression of Gases Apparatus .....	36	Dutrochet's Endosmeter .....	4
Condenser of Epinus .....	82	Dynamometer, Leroy's .....	2
Condensing Lenses .....	62	Dial .....	2
Syringe .....	39	Regnier's .....	2
Conductometers .....	64	Egg Stand .....	86
Contracting Helix .....	105	Egg, Electrical .....	85
Copper Globe .....	33	Elastic Hoop .....	6
Reservoir for Condenser .....	39	Electric Lamps .....	92, 93
Copper-wire .....	86	Light Regulators .....	93
Cotton-covered .....	106	Measurement, Bradley's Ap- paratus for .....	90
Silk-covered .....	106	Electrical Machines, Bertsch's .....	78
Office .....	106	Dielectric .....	79
Cord, White Silk .....	41	Frictional .....	77, 78
Cork-Borers .....	148		

	PAGE		PAGE
Electrical Machines, Holtz.....	79	Foucault's Prism.....	125
Electrical Batteries.....	83	Electric Light Regulator.....	93
Bell.....	80	Heliostat.....	109
Bomb.....	84	Fountain, Expansion.....	35
Bucket.....	80	Hero's.....	23
Chime.....	80	Illuminated.....	109
Dischargers.....	83	Intermittent.....	24
Egg.....	85	In vacuo.....	34, 35
Flier.....	81	Jet.....	39
Inclined Plane.....	80	Frame for Compression (Polarization).....	127
Orrery.....	80	Freezing Apparatus.....	35
Pistol.....	84	Fresnel's Rhomb.....	127
Pyramid.....	84	Fulminating Pane.....	84
See-saw.....	80	Funnels.....	149
Spider.....	81	Funnel Tubes.....	149
Sportsman.....	82	Galvanic Batteries.....	86, 87, 88, 89
Swan.....	81	Lamps.....	92, 93
Swing.....	80	Galvanometers.....	89, 90
Vane.....	80	Gasometers.....	147
Electro-Magnets.....	96	Gassiot's Cascade.....	85, 86
Electrometer, Coulomb's.....	77	Gauge, Barometer.....	31
Gold Leaf.....	76	Siphon.....	32
Quadrant.....	79	Steam.....	40
Thomson's.....	77	Gay Lussac's Apparatus.....	67
Electrometer Jar.....	81	and Thenard's Apparatus.....	68
Electrophorus.....	77	Geissler Tubes.....	102, 103, 120, 121
Electro-plating Tank.....	95	Geometrical Forms.....	3
Electroscopes.....	76	Geyser Illustration.....	56
Bohnenberger's.....	87	Glass Bath.....	123
Elevating Stand for Lanterns.....	134	Glass Plates for Electrical Machines	86
Endosmeter, Becard's.....	4	Rod.....	75
Dutrochet's.....	4	Tumblers for Batteries.....	106
Eolipile.....	65, 148	Globes.....	134, 135, 136
Epinus' Condenser.....	82	Goniometer, Wollaston's.....	109
Equality of Pressure Apparatus ..	19	Governor, Model of Steam.....	8
Equilibrium Figures.....	19	Graduate Glasses.....	149
Tubes.....	20	Graham's Diffusiometer.....	4
Vases.....	20	Gravity, Centre of.....	18
Esculine.....	121	Guard Screw.....	41
Ether Cup.....	84	Guinea and Feather Tube.....	36
Eudiometer.....	147	Gyroscope.....	10
Evaporating Dishes.....	148	Hardy's Inverting.....	11
Expansion Fountain.....	35	With toothed wheel.....	43
Faraday's Muslin Bag.....	75	Hand Glass.....	33
Wire Cylinder.....	75	Hardy's Inverting Gyroscope.....	11
Filtering Paper.....	148	Head of Hair.....	80
Stands.....	148	Heliostat, Silbermann's.....	109
Apparatus.....	148	Foucault's.....	109
Fire House.....	84	Helix on Stand.....	96
Flasks.....	148	for Shocking.....	99
Flier, Electrical.....	81	Three-pole.....	96
Fly-wheel.....	9	Helmholtz' Resonators.....	45
Fluorescent Solutions.....	121	Apparatus.....	45
Flute.....	47	for the Resolution of the	
Water.....	47	"Clang Tints".....	53
Foil, Tin.....	86	Hero's Engine.....	69
Platinum.....	151	Fountain.....	23
Forceps.....	149	Hoffmann's Prisms.....	125, 126
Forcing Pump.....	28		



	PAGE		PAGE
Hollow Globe.....	120	Leroy's Dynamometer.....	2
Hollow Prisms.....	62, 112	Leslie's Radiator.....	60
Hollow Sphere.....	75	Lever, Simple.....	14
Holtz Machine.....	79	Compound.....	15
Hoop, Elastic.....	6	Leyden Jars.....	81
Horizontal Coil.....	96	Liebig's Condenser.....	148
Horseshoe Magnets.....	74, 75	Lifting Coil.....	96
Hydraulic Press.....	22, 23	Lifting Pump.....	28
Ram.....	27	Lightning Jar.....	81
Hydrogen Apparatus.....	146	Lissajous' Apparatus.....	52
Balloon.....	147	Interference Apparatus.....	50
Hydrometers.....	21, 149, 150	Optical Comparer.....	45
Jars.....	21, 150	Lodestone.....	73
Hydrostatic Bellows.....	22	Long and Short Sight, Model of..	129
Paradox.....	22	Luminous Globe.....	84
Hygrodeik.....	72	Pane.....	84
Hygrometers.....	72	Tube.....	84
Illuminated Fountain.....	109	Magdeburg Hemispheres.....	33
Inclination Compass.....	73, 74	Magic Bottle.....	25
Inclined Plane.....	15	Circle.....	97
Electrical.....	80	Funnel.....	25
India-rubber Lens.....	46	Sieve.....	25
Induction Apparatus, Magnetic...	99	Telescope.....	108
Arago's.....	99	Magnesium Lamp.....	107
Babbage & Herschel's.....	99	Magnets, Bar.....	73
Induction Coils.....	101, 102	Horseshoe.....	74, 75
Cylinders.....	76	Horseshoe, Compound.....	75
Globe.....	76	Electro.....	96
Machines, Clarke's.....	100	Magnetic Engine, Page's.....	105
Tubes.....	103	Engine, Double Beam.....	105
Inertia Apparatus.....	4	Induction Apparatus.....	99
Table.....	8	Interrupter.....	43
Insulated Conductor.....	81	Needle.....	73
Insulating Stool.....	80	Manometer, Barometric.....	31
Interference Apparatus of Lissajous.....	50	Closed.....	40
of Light Apparatus.....	124	Comparative.....	40
Bench.....	124	Compound Open.....	40
Tube.....	50	Differential.....	40
Intermittent Fountain.....	24	Open.....	40
Interrupters, Diapason.....	52	Steam.....	40
Interrupter, Magnetic.....	43	Manometric Flames Apparatus..	46, 52, 53
Jamin's Ingenhouse Conductometer.....	64	Mariotte's Law Apparatus.....	36, 67
Jamin's Interference Apparatus..	124	Vase.....	24
Kaleidophone.....	53	Marloye's Harp.....	49
Kaleidoscope.....	108	Mechanical Paradox.....	18
Kinnersley's Thermometer.....	84	Powers.....	13, 14
Kundt's Vibroscope.....	53	Melde's Apparatus.....	41
Lamp, Galvanic.....	92, 93	Melloni's Apparatus.....	62
Electric.....	92, 93	Tyndall's Addition to.....	63
Magnesium.....	107	Membranes, Circular, Square, etc.	47
Leaning Tower.....	18	Mercury Funnel.....	38
Lens of India-rubber.....	46	Trough.....	150
Lenses, Achromatic.....	113	Metal Holder for Spectroscope...	117
Condensing.....	61, 62	Metallic Plates for Dancing Images	81
Crown Glass.....	112	Metre and Yard.....	1
Demonstration.....	112	Mica Plates.....	124, 126, 127
View.....	123	Micro-Photographic Apparatus...	123
		Micro-Spectroscope.....	119
		Millimetre Scales.....	115

	PAGE		PAGE
Mirrors, Burning.....	61	Photographic Accessories.....	123
Claude Lorraine.....	110	Cameras.....	122, 123
Concave.....	110	Lenses.....	123
Convex.....	110	Tent.....	123
Conical.....	110	Photometers.....	107
Cylindrical.....	110	Picnometers.....	150
for Galvanometers.....	90	Pipettes.....	149
Plane.....	108	Pistol, Electrical.....	84
Miser's Plate.....	82	Pith Balls.....	75
Mitscherlich's Apparatus.....	129	Images.....	81
Tubes.....	116	Planetariums.....	136
Models of Crystals.....	3	Plateau's Apparatus.....	11
the Eye.....	129	Plate Paradox.....	39
Steam Governor.....	8	Plates for Electrical Machines.....	86
Mohr's Burettes.....	149	Platinized Silver.....	106
Monochromatic Light Apparatus.....	147	Platinum Foil.....	151
Mortars.....	150	for Batteries.....	106
Mouthpiece.....	43, 147	Sponge.....	151
Muslin Bag of Faraday.....	75	Spoons.....	151
Newton's Disk.....	113	Wire.....	150, 151
Interference of Light Appa- ratus.....	124	Plücker Tubes.....	103, 118
Nicholson's Balance.....	21	Stand for.....	118
Nicol's Prisms.....	125	Pneumatic Trough.....	151
Nitre, Plate of.....	127	Polariscope, Arago's.....	128
Non-conduction of Water Appa- ratus.....	64	Babinet's.....	128
Oersted's Apparatus for Compres- sion.....	4	Savart's.....	128
Magnetic Apparatus.....	89	Senarmont's.....	128
Ohm.....	90	for Projection.....	128
Oil, Bottle of.....	41	Polymagnet.....	97
Optical Comparer of Lissajous....	45	Porous Cups.....	106
Organ Tubes.....	46, 47, 51	Porte Lumière.....	109
Set of two.....	51	Pouillet's Apparatus.....	67
Set of five.....	51	Powder, Apparatus for firing.....	35, 84
Orrery.....	136	Bomb.....	84
Orrery, Electrical.....	80	Cup.....	92
Oxygen Apparatus.....	146	Primary and Secondary Coils.....	99
Ozonometer.....	150	Prismatic Cylinder.....	7
Page's Reciprocating Engine.....	105	Prism, Achromatic.....	113
Palm Glass.....	65	Babinet's Compensating.....	127
Parabolic Reflectors.....	46, 60, 110	Conical.....	112
Paradox, Ball.....	39	Double Image.....	128
Culinary.....	65	Flint Glass.....	112, 113
Hydrostatic.....	22	Foucault's.....	125
Mechanical.....	18	Hoffmann's.....	125, 126
Plate.....	39	Hollow.....	62, 112, 113
Parallelogram of Forces.....	12	in Brass Box.....	113
Pascal's Vases.....	22	Nicol.....	125
Pendulum Apparatus.....	16	Pouillet's.....	124
Beating Seconds.....	16	Rectangular.....	112
Compensating.....	56	Rock-salt.....	62
Philosopher's Lamp.....	43	Psychrometer, August's.....	72
Phonautograph.....	51	Pulleys, Model of.....	13
Phosphorescent Tubes.....	103, 120, 121	Pump, Model of Forcing.....	28
Phosphorus Apparatus.....	83	model of Lifting.....	28
Cup.....	147	model of Lifting, in Vacuo... Plate.....	35 32
Photodrome.....	130	Pulse Glass.....	65
		Pyramid, Electrical.....	84
		Pyrometer.....	55



	PAGE		PAGE
Pyrometer, Wedgwood's.....	56	Sensitive Flames, Apps. for.....	50
Quadrant Electrometer.....	79	Sheet Rubber.....	41
Quartz Plates.....	126, 127	Shellac Rod.....	75
Radiation and Reflection Apparatus.....	60	Silbermann's Heliostat.....	109
Receivers.....	32	Silvered Band for Caustics.....	108
Rectangular Prisms.....	112	Silvered Beads, String of.....	41
Reed Pipes—Beating Reed.....	50	Singing Flames, Apparatus for ...	50
Free Reed.....	50	Siphon.....	24
Set of Eight, with Mirrors...	53	Gauge.....	32
Reflection Apparatus.....	107, 108	Siren, Cagniard de Latour.....	43
of Motion, Apps. to illustrate	6	Helmholtz'.....	44, 51
Reflectors, Parabolic.....	46, 60, 110	Oppelt's.....	44
Refraction Apparatus.....	111	Seebeck's.....	44
Model.....	111	Sodium Reversal Apparatus.....	118
Register for Whirling Machine....	9	Soleil's Saccharimeter.....	129
Regnault's Chronograph.....	52	Solenoid.....	96
Regnier's Dynamometer.....	2	Sonometers.....	48
Regulators for Electric Light....	93	Cords.....	48
Reservoir, Copper.....	39	Spark Condenser.....	117
Reservoir, Glass.....	39	Spatulas.....	151
Resistance Fans.....	37	Specie Jars.....	151
Resonant Jars.....	46	Specific Gravity Balances.....	21, 146
Resonators, Helmholtz'.....	45	Heat Apparatus.....	66
Resultant Table.....	7	Spectroscopes.....	114, 115
Retort, Copper.....	146	for Projection.....	119
Glass.....	151	Spectroscopic Material.....	120
Stands.....	151	Spectrum Tubes.....	103
Revolving Armatures.....	105	Spherometer.....	1
Coil.....	105	Spider, Electrical.....	81
Electro-Magnet.....	105	Spirit Lamps.....	54
Globe.....	80	Sportsman, Electrical.....	82
Jet, Air.....	37	Spouting Fluids, Vessel for.....	25, 26
Jet, Water.....	39	Spring Balance.....	2
Magnet.....	105	Spring Compressors.....	149
Spur-Wheel.....	105	Spur-Wheel, Revolving.....	105
Rheostats.....	90	Standard Barometer.....	29
Rhumkorff Coils.....	101, 102	Stand for Lanterns.....	134
Ritchie's Apparatus for Radiation, etc.....	61	Steel Tape.....	1
Rock-salt Prism.....	62	Steam-Engine.....	69, 70
Rochon Telescope.....	124	Models of.....	70, 71
Rotators for Geissler Tubes, etc..	130	Steam Gauge.....	40
Rubber Bags.....	58, 146, 147	Whistle.....	43
Cells for Batteries.....	106	Stereoscopes.....	131
Sheet.....	41	Achromatic.....	131
Rod.....	75	Stop-Cocks.....	41
Rubber Tubing.....	41	Stroboscopic Analyzer.....	53
Saccharimeter, Soleil's.....	129	Sugar, Plate of.....	127
Savart's Bell and Resonator.....	46	Sulphate of Quinine.....	121
Toothed Wheel.....	43	Nickel.....	126
Safety Lamp, Davy's.....	64	Supports for Chladni Plates.....	49
Saussure's Hygrometer.....	72	Swan, Electrical.....	81
Screw.....	15	Swiftest Descent Apparatus.....	15
Couplings.....	41	Swing, Electrical.....	80
Sectional Model of Steam-Engines	70, 71	Syringe, Condensing.....	39
Seebeck's Ear.....	46	Tantalus Cup.....	24
See-saw, Electrical.....	80	Telegraph Model, Dial Form.....	97
Selenite Films.....	126, 127	Morse's.....	98
		Telegraph Keys.....	98
		Relay.....	98

	PAGE		PAGE
Telegraph Sounder.....	98	Vase, Circular.....	42
Tellurians.....	136, 137	Elliptical.....	42
Tension of Vapor Apparatus.....	66	Rectangular.....	42
Tent, Photographic.....	123	Vernier, Model of.....	1
Test Tubes.....	151	Verre Trempe.....	127
Rack for.....	151	Vertical Circle.....	107, 108
Thaumatrope.....	130	Vibrating Bell and Balls.....	49
Thermo-Electric Arch.....	104	Rods and bars.....	48
Battery.....	103	Violin Bow.....	43
Multiplier.....	103, 104	Voltaic Pistol.....	92
Pair.....	103	Voltameter, Chemical.....	94
Thermometer, Alcohol.....	57	Volta's Column Battery.....	86
Breguet's Metallic.....	56	Hail Storm.....	81
Comparative.....	57	Vulcanite Plate.....	75
Kinnersley's.....	84	Waltzers.....	18
Leslie's Differential.....	57	Wash Bottle.....	146
Matthiessen's Differential.....	57	Washers, Leather.....	41
Maximum of Negretti and Zambra.....	59	Watch Glasses.....	151
Maximum of Walferdin.....	58	Water Hammer.....	37, 43
Mercurial.....	57	Water Pump in Vacuo.....	35
Metastatic, of Walferdin.....	58	Water-Wheels, Model of.....	27
Minimum, of Walferdin.....	58	Turbine.....	28
Minimum, of Rutherford.....	59	Wave Apparatus, Dickerson's.....	42
Normal or Standard.....	57	For Projection.....	42
Six's Maximum and Minimum.....	59	Rood's.....	42
Thermo-Multiplier.....	59	Wheatstone's.....	42
Thomson's Electrometer.....	77	Wave Canal, Weber's.....	42
Thousand-Grain Bottle.....	21	Wedge.....	15
Tin Foil.....	86	Cells.....	119, 120
Tissue Figure.....	80	Wedgewood's Pyrometer.....	56
Torsion Balance, Coulomb's.....	74	Weights, Apothecary.....	2
Tourmalines.....	125	Weights, French.....	2
Transferrer, for Gases.....	39	Troy.....	2
Transmission of Vibrations.....	50	Wertheim's Apparatus.....	43
Trevelyan Rocker.....	43	Wheatstone's Kaleidophone.....	53
Tubes, Acoustic.....	50	Whirling Machine.....	7
Tripod Stand.....	123	Table.....	8
Tumblers, for Batteries.....	106	Whistling Tube.....	43
Chinese.....	19	Whitall's Planisphere.....	137
Turbine Water-wheel.....	28	Wind Mill.....	37
Tyndall's Addition to Melloni's Apparatus.....	63	Wire, Copper.....	86, 106
Universal Discharger.....	83	Platinum.....	150, 151
Universal Lanterns.....	132, 133	Wire Cylinder, Faraday's.....	75
Mouthpiece.....	43	Gauze.....	64
Upward Pressure Apparatus.....	19, 38	Guard.....	38
Uranium Glass, Block of.....	86, 121	Wollaston's Engine.....	69
Urinometers.....	150	Goniometer.....	109
U Tube.....	94	Woulfe's Bottles.....	151
Valve Cap.....	38	Zamboni's Pile.....	87
Vane, Electrical.....	80	Zincs for Batteries.....	106
		Zoetrope.....	130