

AMERICAN SCHAEFFER & BUDENBERG

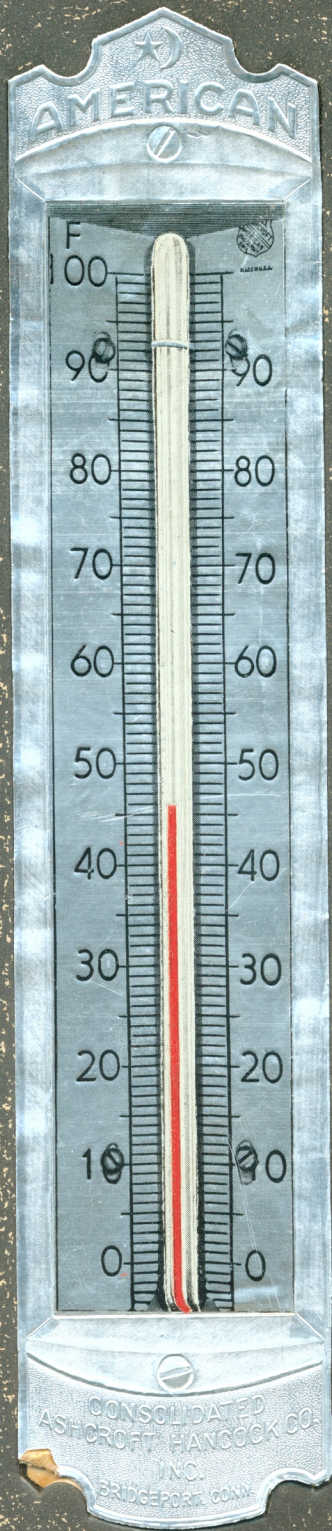

AMERICAN

Catalog 200  
September, 1934

# AMERICAN THERMOMETERS

AMERICAN SCHAEFFER & BUDENBERG DIVISION

Consolidated Ashcroft Hancock Company

Incorporated

*General Sales Offices and Factory*  
Bridgeport, Conn.

*Western Sales Office*  
605 West Washington Boulevard, Chicago

*Pacific Coast Sales Office*  
2318 East 8th Street, Los Angeles  
Branches in Principal Cities

*For Canada*  
Mechanical Equipment Co., Montreal  
Kipp-Kelly, Limited, Winnipeg

SUBSIDIARY OF MANNING, MAXWELL & MOORE, INC.

Copyright, 1934

CONSOLIDATED ASHCROFT HANCOCK COMPANY

Incorporated

# American Schaeffer & Budenberg Division

---

*American Thermometers are manufactured by the American Schaeffer & Budenberg Division of Consolidated Ashcroft Hancock Company—makers of precision instruments since 1850.*

**A**MERICAN Indicating Thermometers are made to serve industry in the correct measurement of temperatures. To provide greatest utility value, American Thermometers have been improved to add ease of reading and beauty to the accuracy that has always been inherent in them.

## EASE OF READING

American Indicating Thermometers are made with Red Reflecting Mercury tubing as standard in all ranges up to 750° F. or equivalent. This Red Reflecting Tubing shows the mercury column as a broad red stripe which is highly visible.

The scales are made with silver finish background on which the black figures and graduation lines stand out boldly.

This combination of Red, Silver and Black makes American Thermometers easy to read in a poor light or from a considerable distance.

## BEAUTY

American Indicating Thermometers are now made with highly polished chromium plated frames as standard. The case back is sand blast finished and nickel plated.

The illustration on the outside cover of this catalog is a facsimile reproduction of an American Indicating Thermometer. All Thermometers listed on pages 208 to 229 inclusive are made with this finish as standard.

## ACCURACY

American Indicating Thermometers are made by skilled workmen with a background of many years experience. Test Thermometers certified by the U.S. Bureau of Standards are used as masters for all calibrating. Modern testing, calibrating and heat treating equipment assures the maintenance of the highest possible standards of accuracy. These are the reasons why American Indicating Thermometers are guaranteed to be accurate within one scale division.

## The Graduation of the Scale

**T**HE scale of each American Thermometer is graduated to order according to the requirements. Such graduations found on the scales of Thermometers illustrated in this Catalog are merely illustrative and must not be taken into consideration except when so stated in connection with Thermometers intended for some specific use.

The maximum number of subdivisions on the scale of glass front Thermometers is 100 on the 7" scale size, 130 on 9" and 175 on 12".

The following Fahrenheit ranges are widely used and have become standard through practice to a considerable extent.

-20 to plus 70	30 to 240	100 to 550
-20 to plus 120	170 to 270° F. & P.*	100 to 650
0 to 100	50 to 350	100 to 750
30 to 160	200 to 350° F. & P.*	200 to 750
30 to 220	50 to 400	200 to 900
100 to 220		200 to 950

\*Corresponding pressure in pounds per square inch.

### Expansion Chamber

In selecting the scale for a Thermometer, keep in mind that the range of temperature between the minimum and maximum scale reading determines the spacing of the subdivisions. Therefore, do not select a range any wider than absolutely necessary if an open yet finely subdivided scale plus reading convenience is wanted.

At the top of the Tube in every American Glass Front Thermometer is an expansion chamber (see illustration). This prevents damage should the Thermometer be subjected to a temperature higher than the maximum scale reading, thus permitting the use of a Thermometer graduated for the working range only, even if occasionally the temperature rises above this range.

### Scale Options

American Thermometers are supplied with scales graduated either in Fahrenheit, Centigrade or Reaumur. Also with combination scales, showing the temperature and corresponding saturated vapor pressure of Steam, Ammonia or other liquids.

### Blind Scale

When it is desired to maintain secrecy as to the temperatures used in certain processes, the scale can be arranged so that the Thermometer indicates higher or lower than the actual temperature, or letters in place of figures can be furnished. There is no extra charge for equipping American Glass Front Thermometers with these "blind" scales.

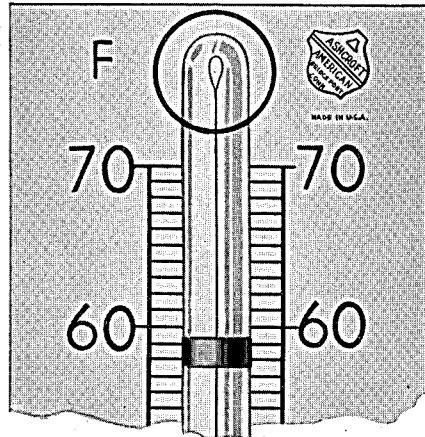

### IMPORTANT NOTES

*American Thermometers with Scale Range graduated up to 750° F. or equivalent in C., may be subjected to that temperature continuously without injury.*

*When graduated to 900° F. or equivalent in C., Thermometers can be subjected to that temperature intermittently, but not higher than 800° F. continuously.*

*950° F. or equivalent in C. Thermometers may be used for occasional tests up to the scale limit but not continuously above 900° F.*

## Stem Construction of the Standard American Glass Front Thermometer

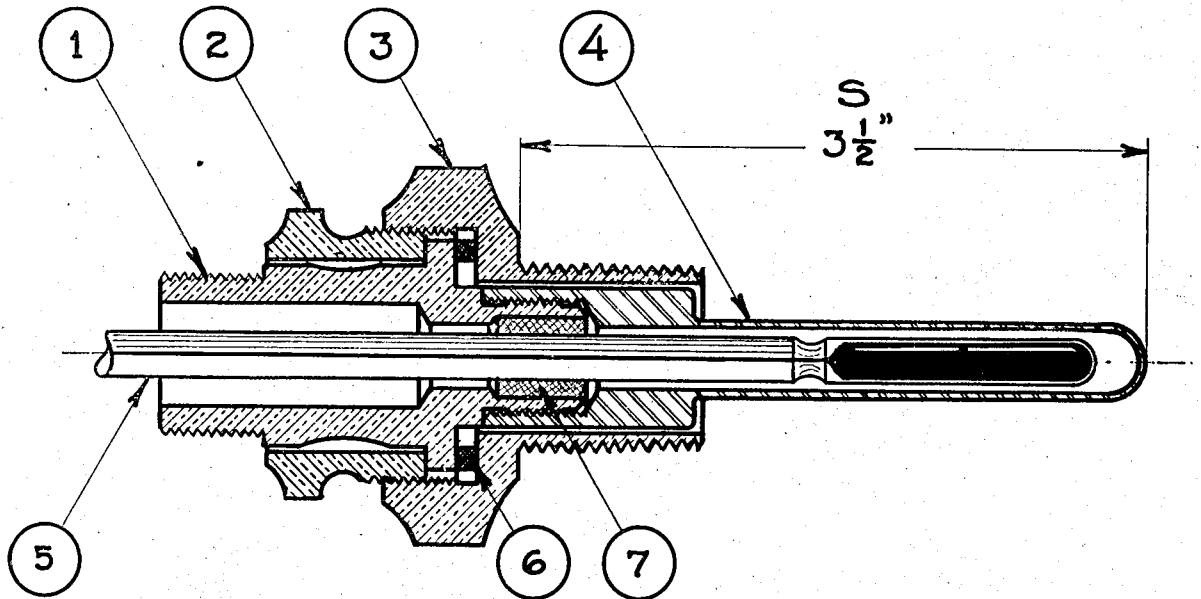

1. Brass Neck.
2. Brass Swivel Nut.
3. Brass Union Bushing cut from hexagon rod which secures accurate wrench head dimensions and better appearance than rough castings usually used.
4. Monel Metal Bulb Chamber is standard only on American Thermometers. Monel is the only NON-CORRO-SIVE metal which will hold mercury. It will not bind in the socket under any condition. The Space between the Monel Bulb Chamber and the Glass Bulb is also filled with mercury for instantaneous transmission of temperature changes.
5. The Glass Tube of every American Thermometer, including all ranges, is thoroughly annealed for 6 days so that permanent accuracy results. Very fine bore glass is used between the bulb and the scale part of the glass tube to reduce the stem error to a minimum.
6. The Packing Ring is made of high pressure, high temperature packing, hard but sufficiently compressible for a tight joint.
7. Asbestos Packing to hold the mercury in the bulb chamber.

### LONG STEM THERMOMETERS

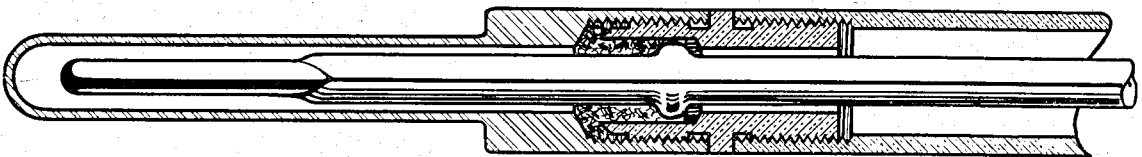

On all long stem thermometers, the glass tubing has a button to prevent any possible slipping of the tube in the stem, which would necessarily affect the accuracy. This button is held in a rigid position by the asbestos packing as shown.

## Stem Connections

These illustrations show the three standard stem connections, fixed connection, union connection and separable socket connection. The kind of connection is determined by the application and use of the thermometer.

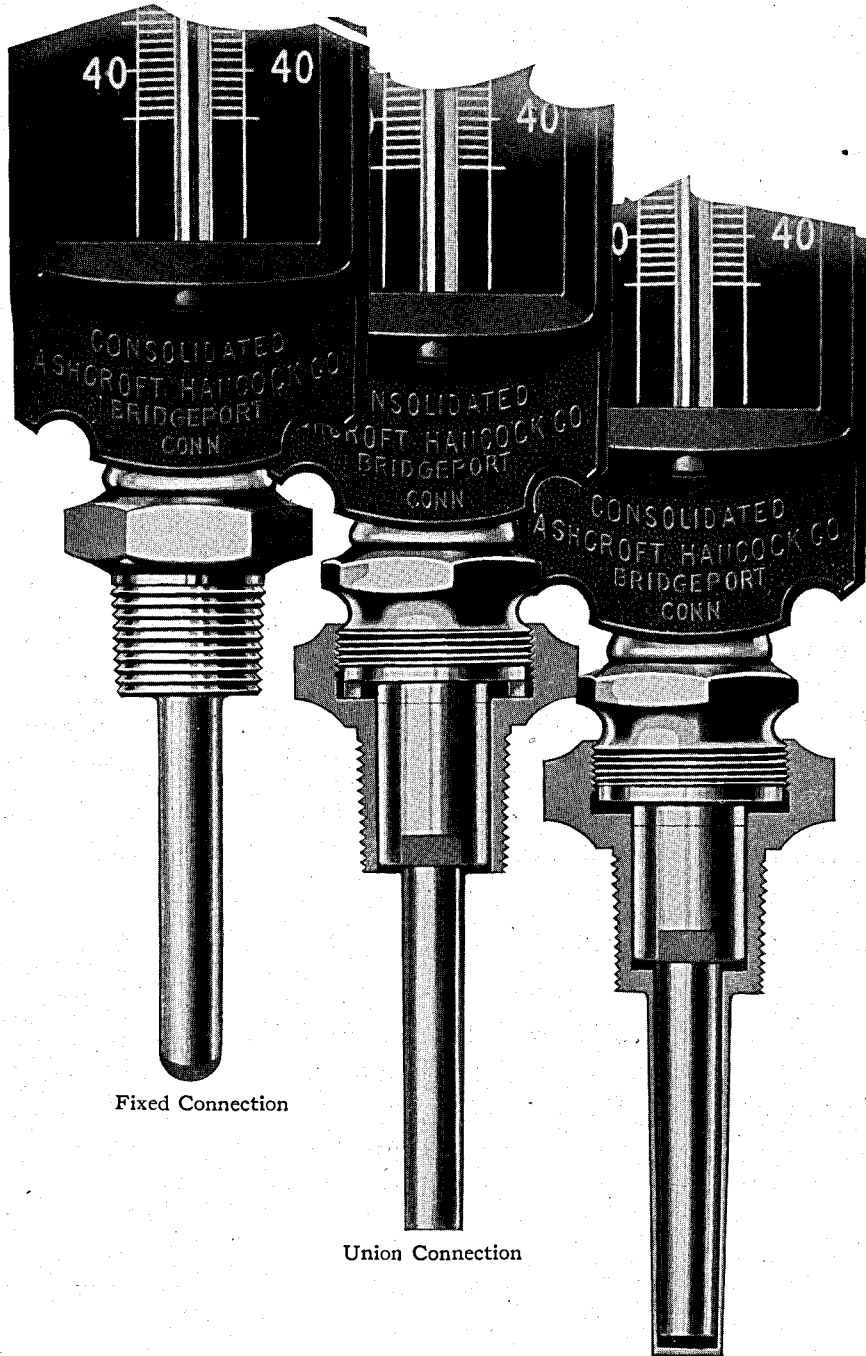

Fixed Connection

Union Connection

Separable Socket Connection

## A Few Standardized Uses of American Thermometers and Specifications

### HEATING

*Air Duct*—Type 240 American Air Duct Thermometer shown on page 220, 9 or 12" scale, graduated 0-160° F., 6", 12", 18" or 24" perforated stem, Union Connection and Union Flange.

### ICE AND REFRIGERATION

*Ammonia Lines*—Types 248, 250, 252 and 254 American Thermometers with Extension Necks, shown on pages 222 to 225, 7, 9 or 12" scales graduated —20 to plus 120° F. Steel Separable Socket.

*Brine Pipes*—Types 248, 250, 252 and 254 American Thermometers with extension neck shown on pages 222 to 225, 7, 9 or 12" scales graduated —20 to plus 120° F. Separable Socket (Bronze) recommended.

*Brine Tank*—Type 226 American Brine Tank Thermometer shown on page 217, 12" scale, regular or reclined, graduated —20 to plus 100° F. 36" stem with Clamp Flange, Type 73.

*Cold Storage*—Type 246 American Cold Storage Thermometer shown on page 221, 12" scale, graduated —10 to plus 70° F. Insulated Wall Fitting of required size, with Lock Nut Stem approximately 8" from end of fitting. Exposed mercury chamber and perforated bulb guard.

### CANNING

*Process Kettles*—Standard Straight Form (page 208) and Reclined Scale Case Form (page 228) American Thermometers, 7, 9 or 12" scale, graduated 170° to 270° F. and corresponding pounds pressure 0 to 20 lbs. Fixed Union or Separable Socket Connection.

*Exhausters*—Types 236 and 238 Side Angle Thermometers (page 219) 7 or 9" scale, graduated 100 to 220° F., Union Connection with Bushing or Flange.

*Pea Blanchers*—Standard Angle Thermometers (page 210) 9 or 12" scale graduated 100 to 220° F., Union Connection.

*Continuous Cookers, Blanchers, etc.*—Types 236 and 238 Side Angle Thermometers (page 219) 7, 9 or 12" scale, graduated 30 to 240° F., Union Connection.

*Cookers, Sterilizers, Exhausters, Syruping Tanks, etc.*—Standard Straight (page 208) and Standard Angle (page 210) Thermometers 7, 9 or 12" scale, graduated 30 to 240° F., Fixed Union or Separable Socket Connection.

*Corn Cookers*—Standard Angle Thermometer (page 210) 9 or 12" scale, graduated 100 to 220° F., Union Connection and Flange.

### POWER HOUSE

*Condensers*—All Standard Straight and Angle Form American Thermometers (pages 208 to 211) with 7, 9 or 12" scale, graduated 30-160° F. Fixed, Union or Separable Socket Connection.

*Superheated Steam*—All Straight and Angle Form American Thermometers (pages 208 to 211). With 9 or 12" scales, graduated 200-750° F. Separable Socket Connection and Phosphor Bronze Separable Socket, or Steel Socket, for higher temperatures.

*Economizers*—All Straight and Angle Form American Thermometers (pages 208 to 211). With 7, 9 or 12" scale, graduated 50-400° F. Fixed, Union or Separable Socket Connection. Bronze Socket recommended.

*Feed Water*—All Straight and Angle Form American Thermometers (pages 208 to 211). With 7, 9 or 12" scale, graduated 40-240° F. Fixed, Union or Separable Socket Connection.

*Flue Gas*—Type 232 Thermometer on page 217, 12" scale graduated 200-950° F., Steel Stem 30 inches long, Adjustable Clamp Flange, Type 73.

### LUMBER

*Dry Kilns*—Standard American Long Stem Straight or Angle Thermometer shown on pages 212 and 218, 12" scale graduated 40-220° F. (or other ranges as required) 6", 12", 18" or 24" Stem with Perforated Guard, Union Connection and Union Flange.

### GAS

*Gas Mains*—Standard Straight and Angle Form American Thermometers (pages 208 to 211). With 7, 9 or 12" scales, graduated 30-170° F. Fixed or Union or Separable Socket Connection, the latter with Cast Iron Separable Socket.

### BAKING

*Oven (Bakers)*—Type 244 American Bakers' Oven Thermometer shown on page 220, 9 or 12" scale, graduated 200-750° F., 24" 30", 36" or 48" Stem, perforated Bulb Guard, no Connection, Adjustable Clamp Flange if desired.

### DAIRY

*Pasteurizer*—Type 277 American Pasteurizer Thermometer shown on page 221, 7 or 9" scale graduated 60 to 160° F., Sanitary Wall Fitting, Regular or Side Angle Form.

*Pasteurizer (Portable)*—Type 220 American Portable Pasteurizer Thermometer shown on page 216. Aluminum Case, Glass Front, 10" scale, graduated 60 to 160° F. Ring on top of Case, Handle below case, nickel stem 24", 30" or 36" long.

*Platform or Milk Inspector Thermometer (Cold Milk Testing)*—Type 218 American Platform Thermometer shown on page 216. Aluminum Case, Glass Front, 7" scale graduated 0-90° F., 14" Stem, Tinned.

### OIL REFINING

*Still (Crude Oil)*—American Combination Extension Neck and Stem Angle Form Thermometer Type 254 shown on page 224, 12" scale graduated 100-750° F., (or other range as required). Steel Extension Neck Separable Socket, 4" Extension Neck, 12" Stem.

### MISCELLANEOUS

*Varnish*—Type 228 American Varnish Thermometer shown on page 217. Aluminum Case, Glass Front, Ring on top of case for hanging, 12" scale, graduated 200-750° F., stem 36" long, with exposed Copper-Plated Bulb and Wire Guard.

*Molten Metal and Asphalt, Electrotype Metal Pots, Solder Pots, Galvanizing Baths, Asphalt Testing, etc.*—Type 230 American Thermometer shown on page 217. Aluminum Case, Glass Front, Ring on top of Case for hanging, 12" scale, graduated 200-750° F., or 200-950° F., Stem of Cast Iron, 18" long.

*Ovens, Enameling, Japanning, etc.*—Type 242 American Oven Thermometer shown on page 220, 9 or 12" scale, graduated 50 to 500° F. Wall Fitting with running Thread and Locknut, 6" Stem, measured from end of fitting, Perforated Bulb Guard.

*Cruller Frying (or other open kettle cooking using hot fats)*—Type 224 American Thermometer. Aluminum Case, glass front, 10" scale, graduated 200-750° F., 14" Stem, Handle and Ring on top of case.



# Standard Straight Stem American Glass Front Thermometer

With Bulb Chamber of Monel Metal

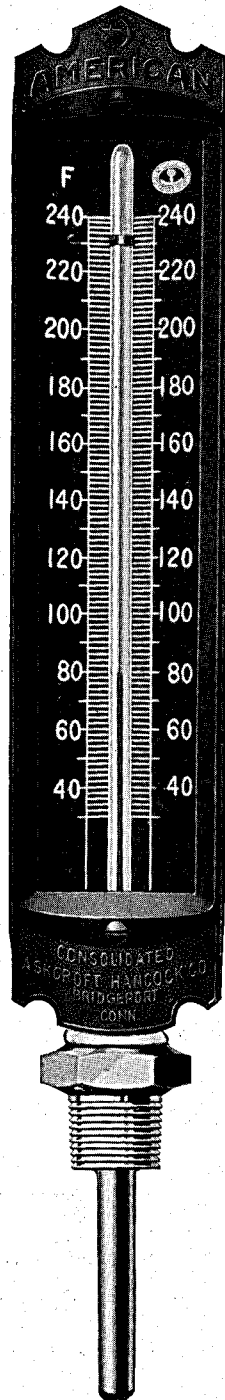

With Fixed, Union or Separable Socket Connection. Illustration shows Thermometer with Fixed Connection.

With 7", 9" or 12" scale, graduated for any range of temperature not exceeding 950° F.

Monel Metal Bulb Chamber. Non-corrosive—will not bind in Socket.

## American Thermometers Are Easy To Read!

For all temperatures up to 750° F. or equivalent, mercury filled Red Reflecting tubes are used. With these tubes, the mercury appears as a broad red stripe.

For temperatures above 750° F. or equivalent Boro Silicate glass is used.

Carried in Stock at all Branches

Standard Straight Stem American Thermometers, with 9" scale and following ranges are carried in stock at all Branches:

- 20 to + 120° F.
- 30 to 160° F.
- 30 to 240° F.
- 170 to 270° F. & P.
- 200 to 350° F. & P.
- 50 to 400° F.
- 100 to 550° F.
- 100 to 750° F.

## Stock Connections

Fixed, Union or Separable Socket Connection for ranges up to 400° F., inclusive.

Higher ranges with Separable Socket Connection only.

# American Schaeffer & Budenberg Division

**T**HE American Glass Front Thermometer is essentially different, for diverse applications, only in the character and arrangement of stem, graduation of scale and in the style of connection necessary to effect proper installation.

The opposite illustration shows the Standard Straight Stem American Thermometer. On the following pages are illustrated and described other Straight Form Thermometers with various types of stem arrangements.

The American Glass Front Thermometer case is constructed of brass nickel plated. The scale is "V" shaped and protected by a removable chromium plated frame and with plate glass front.

All American Glass Front Thermometers are provided with Bulb Chamber of Monel Metal assuring maximum strength and protection from corrosion. Of particular advantage in Separable Socket Thermometers is the Monel Metal Bulb Chamber as it cannot bind in the Socket. American Straight Stem Thermometers are carried in stock at all Branches in standard ranges listed.

## LIST PRICES

### American Standard Straight Form Thermometers

*Prices apply for any temperature range not exceeding 750° F., 400° C. or 320° R.*

*For temperature ranges over 750° F. but not exceeding 900° F., 480° C. or 385° R. add to list prices.....Each \$5.00*

*For temperature ranges up to 950° F., 500° C. or 400° R. add to list prices.....Each \$10.00*

### CONNECTION

Type 201 Code word LBJA			Type 202 Code word LBJB			Type 203 Code word LBJC		
Fixed Thread			Union, including Standard Bushing			Separable Socket, including Standard Socket of Bronze or Steel		
Size of Scale			Size of Scale			Size of Scale		
7 Inch	9 Inch	12 Inch	7 Inch	9 Inch	12 Inch	7 Inch	9 Inch	12 Inch
\$12.50	\$16.00	\$19.50	\$15.50	\$19.00	\$22.50	\$18.50	\$22.00	\$25.50

All prices are subject to discount

Stem length including thread is 3½ inches. Standard connection is ¼" Standard Pipe Thread and will be supplied unless otherwise stated. Fixed Connection Thermometers can be furnished ½" Standard Pipe Thread at an extra charge of \$.50 list. 1" connection supplied to order without extra charge. Extra charge for 1¼" connection \$3.50. Extra charge for 1½" connection \$4.00

### Reference Index

*For Standard Angle Form Thermometers see following page.*

*Prices of extra Separable Sockets and Sockets of special material to withstand corrosive action, etc., on pages 232 and 233.*

*For Long Stem Types see pages 212 and 213.*

*Prices of Union Bushings on page 230.*

*For extension Neck Types see pages 222 and 223.*

*Flanges on page 231.*

*For extremely accurate reading, the glass tubes may be etched to correspond with the metal scale at an extra charge of \$3.00 list.*

*A Factory Test Certificate will be issued with any of the above thermometers when requested, at no extra charge.*

# Standard Angle Stem American Glass Front Thermometer

With Bulb Chamber of Monel Metal

With Fixed, Union or Separable Socket Connection. Illustration shows Thermometer with Union Connection.

With 7", 9" or 12" scale graduated for any temperature range not exceeding 950° F.

Monel Metal Bulb Chamber. Non-corrosive—will not bind in Socket.

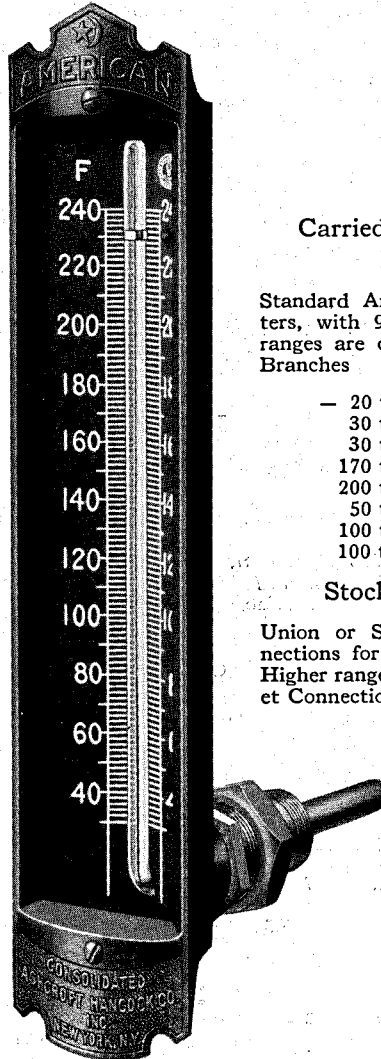

Carried in Stock at all Branches

Standard Angle Stem Thermometers, with 9" scale and following ranges are carried in stock at all Branches

- 20 to + 120° F.
- 30 to 160° F.
- 30 to 240° F.
- 170 to 270° F. & P.
- 200 to 350° F. & P.
- 50 to 400° F.
- 100 to 550° F.
- 100 to 750° F.

Stock Connections

Union or Separable Socket Connections for ranges up to 400° F. Higher ranges with Separable Socket Connection only.

## American Thermometers Are Easy To Read!

For all temperatures up to 750° F. or equivalent, mercury filled Red Reflecting tubes are used. With these tubes, the mercury appears as a broad red stripe.

For temperatures above 750° F. or equivalent Boro Silicate glass is used.

# American Schaeffer & Budenberg Division

**T**HE American Thermometer illustrated opposite shows the Standard Angle Stem designed for application to vertical pipes and to sides of tanks or other apparatus. Various other types of Angle Form Thermometers with regard to stem and scale arrangements are illustrated and described on succeeding pages.

As emphasized previously, to enable convenient installation the use of the Union Connection is strongly recommended for all applications of the Angle Form Thermometer when the Separable Socket Connection is not required.

All American Glass Front Thermometers are provided with Bulb Chamber of Monel Metal, thus assuring maximum strength and protection from corrosion. This is of particular advantage in Separable Socket Thermometers as the Monel Metal Bulb Chamber cannot bind in the Socket. American Angle Stem Thermometers are carried in stock at all Branches in standard ranges listed.

## LIST PRICES

### American Standard Angle Form Thermometers

*Prices Apply for any Temperature Range not Exceeding 750° F., 400° C. or 320° R.*

*For temperature ranges over 750° F., but not exceeding 900° F., 480° C. or 385° R. add to list prices, Each.....\$5.00*

*For temperature ranges up to 950° F., 500° C. or 400° R. add to list prices.....Each \$10.00*

## CONNECTION

Type 204 Code word LBJD Fixed Thread			Type 205 Code word LBJE Union, including Standard Bushing			Type 206 Code word LBJF Separable Socket, including Standard Socket of Bronze or Steel		
Size of Scale			Size of Scale			Size of Scale		
7 Inch	9 Inch	12 Inch	7 Inch	9 Inch	12 Inch	7 Inch	9 Inch	12 Inch
\$15.50	\$19.00	\$22.50	\$18.50	\$22.00	\$25.50	\$21.50	\$25.00	\$28.50

All prices are subject to discount.

Stem length including thread is 3½ inches. Standard connection is ¼" Standard Pipe Thread and will be supplied unless otherwise stated. Fixed Connection Thermometers can be furnished ½" Standard Pipe Thread at an extra charge of \$.50 list. 1" connection supplied to order without extra charge. Extra charge for 1¼" connection \$3.50. Extra charge for 1½" connection \$4.00.

### Reference Index

*For Side Angle Types see page 219.*

*For Long Stem Types see page 218.*

*For Extension Neck Types see pages 224 and 225.*

*Special Angle Types for specific applications on pages 220 and 221.*

*For Oblique Stem Types see pages 226 and 227.*

*For Inclined or Reclined Scale Types see pages 228 and 229.*

*Prices of Extra Separable Sockets and Sockets of special material to withstand corrosive action, etc., on pages 232 and 233.*

*Prices of Bushings on page 230.*

*Flanges on page 231.*

*For extremely accurate reading, the glass tubes may be etched to correspond with the metal scale at an extra charge of \$3.00 list.*

*A Factory Test Certificate will be issued with any of the above thermometers when requested, at no extra charge.*

## American Long Stem Thermometers

### Straight Form

With 7, 9 or 12 inch  
Scale. Any range  
up to 950° F.

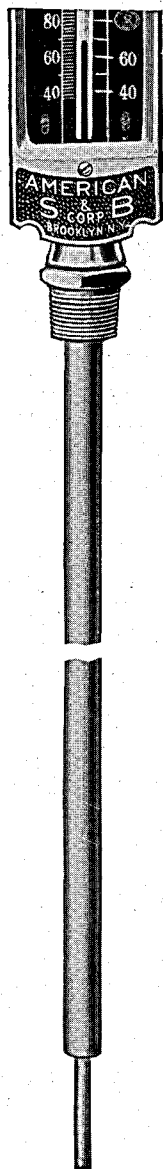

Type 210

Code word—LBAJ

With 7, 9 or 12 inch  
Scale. Any range  
up to 950° F.

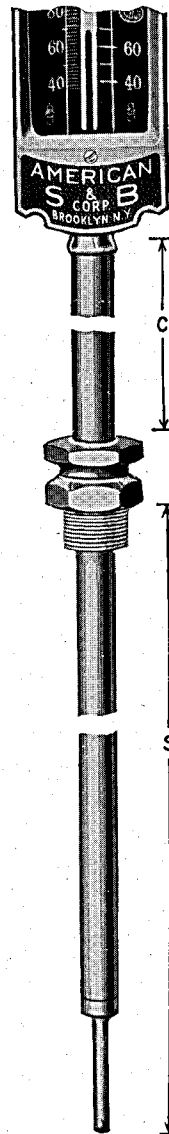

Type 212

Code word—LBAB

**F**OR the purpose of extending into tanks or other apparatus, the American Straight Form Thermometer as shown by Type 210 is equipped with long stem of any required length up to 60".

Frequently, pipes, tanks, mains or other apparatus to which it is desired to connect the Thermometer, are located below surface or below floors. In such instances, installation is accomplished by the use of the Combination Stem Arrangement shown by Type 212.

The extension neck above the threaded connection "C" should be sufficiently long so that when Thermometer is installed, the scale case will extend above the floor or other point of mounting to the proper height for reading convenience. The standard neck is 6". The stem below the connection "S" should be long enough to extend well into the apparatus.

When ordering, specify size of scale, temperature range, type of connection, distance for "C" and for "S" and purpose for which Thermometer will be used.

Standard Stem is of Bronze with Monel Metal Bulb Chamber.

#### Flanges

When attaching Thermometers to any apparatus the wall of which is too thin for fitting a thread, or when, for other reasons, it is undesirable to directly connect the Thermometer through a threaded opening, Flanges can be furnished for bolting or riveting to the apparatus. They are made usually of iron in various sizes and patterns.

Union threaded Flanges have a thread to permit their being used in place of the Union Bushing. For Rigid Connection or Separable Socket Connection Thermometers, Flanges are fitted with standard pipe thread as required.

Price lists of Flanges on page 231.

#### American Thermometers Are Easy To Read!

For all temperatures up to 750° F. or equivalent, mercury filled Red Reflecting tubes are used. With these tubes, the mercury appears as a broad red stripe.

For temperatures above 750° F. or equivalent Boro Silicate glass is used.

# American Schaeffer & Budenberg Division

## American Long Stem Thermometers

### LIST PRICES

Prices Apply for any Temperature Range Not Exceeding 750° F., 400° C., or 320° R.  
 For temperature ranges over 750° F. but not exceeding 900° F., 480° C. or 385° R. add to list prices..Each \$5.00  
 For temperature ranges up to 950° F., 500° C. or 400° R. add to list prices..Each \$10.00

Intermediate length stems take next higher lists.

#### Type 210

Stem Length Including Thread	CONNECTION								
	Fixed			Union			Separable Socket		
	Size of Scale			Size of Scale			Size of Scale		
	7 inch	9 inch	12 inch	7 inch	9 inch	12 inch	7 inch	9 inch	12 inch
6 inch	\$14.00	\$17.50	\$21.00	\$17.00	\$20.50	\$24.00	\$20.00	\$23.50	\$27.00
12 inch	16.00	19.50	23.00	19.00	22.50	26.00	24.00	27.50	31.00
18 inch	18.00	21.50	25.00	21.00	24.50	28.00	28.00	31.50	35.00
24 inch	20.00	23.50	27.00	23.00	26.50	30.00	32.00	35.50	39.00
30 inch	22.00	25.50	29.00	25.00	28.50	32.00	36.00	39.50	43.00
36 inch	24.00	27.50	31.00	27.00	30.50	34.00	40.00	43.50	47.00
48 inch	.....	31.50	35.00	.....	34.50	38.00	.....	51.50	55.00
60 inch	.....	35.50	39.00	.....	38.50	42.00	.....	59.50	63.00

#### Type 212

With Extension Neck "C" 6 inches  
 For Each Additional 3 Inches or Fraction Thereof Add \$1.00.

Stem Length "S" Including Thread	CONNECTION					
	Union			Separable Socket		
	Size of Scale			Size of Scale		
	7 inch	9 inch	12 inch	7 inch	9 inch	12 inch
3½ inch (Std.)	\$20.50	\$24.00	\$27.50	\$23.50	\$27.00	\$30.50
6 inch	22.00	25.50	29.00	25.00	28.50	32.00
12 inch	24.00	27.50	31.00	29.00	32.50	36.00
18 inch	26.00	29.50	33.00	33.00	36.50	40.00
24 inch	28.00	31.50	35.00	37.00	40.50	44.00
30 inch	30.00	33.50	37.00	41.00	44.50	48.00
36 inch	32.00	35.50	39.00	45.00	48.50	52.00
48 inch	.....	39.50	43.00	.....	56.50	60.00
60 inch	.....	43.50	47.00	.....	64.50	68.00

¾" Standard Pipe Thread is standard on Thermometers with stems up to and including 6". 1" Standard Pipe Thread can be supplied to order without extra charge. 1" Standard Pipe Thread is standard for Thermometers with stem longer than 6". ¾" Standard Pipe Thread can be supplied to order (on Fixed and Union Connection Thermometers only) without extra charge. Extra charge for 1¼" connection, \$3.50, 1½", \$4.00.

Union Connection prices include Union Bushing or 3½" Iron Union Flange.

Separable Socket prices include Socket. Sockets longer than 6" are of Drawn Bronze Tubing or Steel Tubing. For Sockets of special material to withstand corrosive action, etc., see pages 230 and 233.

#### Reference Index

For Angle Type see page 218.

For Extension Neck Types see pages 222 and 223.

For Oblique Stem and Inclined and Reclined Scale

Types see pages 226 to 229.

Prices of Bushings on page 230.

Flanges on page 231.

Prices of Extra Sockets and Sockets of special material to withstand corrosion, etc., on pages 232 and 233.

For extremely accurate reading, the glass tubes may be etched to correspond with the metal scale at an extra charge of \$3.00 list.

A Factory Test Certificate will be issued with any of the above thermometers when requested, at no extra charge.

## American Long Stem Thermometers

### Portable Forms

**T**YPES 214 and 216 American Thermometers shown here are expressly designed as portable Thermometers. They are used for the measuring of temperatures in kettles, vats, tanks, etc., of the open type as well as other apparatus not under pressure.

Type 214 is intended for attachment to rim of kettle or vat by means of prong clamp hook. It is also used to extend through the covers of tanks, coolers, etc., by means of adjustable clamp flange. The ring on top of the scale case also permits suspension of Thermometer into kettle or tank by means of cord, pulley and counter-weight arrangement. The adjustable feature of the flange allows the introduction of the proper length of stem into the apparatus. Type 214 Thermometer is furnished with either 9 or 12" scale, aluminum case, graduated for any range not exceeding 1000° F. The ring on top of scale case may be used for hanging when Thermometer is not in use.

Type 216 American Portable Thermometer is used where an occasional testing of a number of open kettles or vats is necessary. When not in use it may be hung up by means of the ring on top of the handle. The use of the double prong clamp hook will be found convenient when the Thermometer is to remain in the apparatus for a short time.

Type 216 Thermometer is furnished with 7 or 10 inch scale, aluminum case graduated for any range not exceeding 750° F.

### American Thermometers Are Easy To Read!

For all temperatures up to 750° F. or equivalent, mercury filled Red Reflecting tubes are used. With these tubes, the mercury appears as a broad red stripe.

For temperatures above 750° F. or equivalent Boro Silicate Glass is used.

When added protection is desired for the Thermometer Stem Wire Bulb Guard can be supplied at extra charge as listed below.

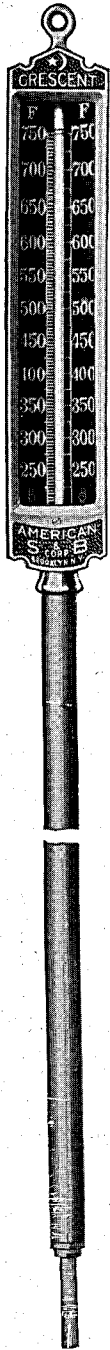

Type 214  
Code word—  
LBAD

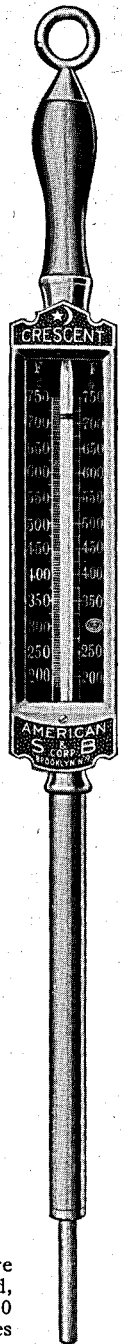

Type 216  
Code word—  
LBAF

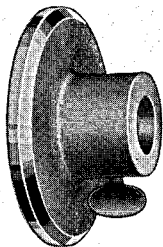

Type 73 Adjustable  
Iron Clamp Flange.  
Price.....\$2.50

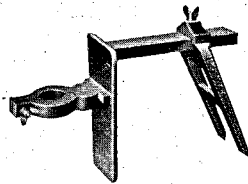

Type 70 Double Support,  
Adjustable Clamp Hook.  
Hold Thermometer Stem  
rigid, preventing it from  
striking inner side of re-  
ceptacle. Price....\$7.50

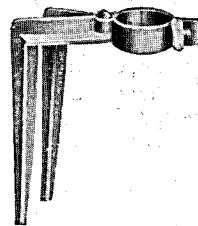

Type 78 Prong  
Clamp Hook. For  
maximum width  
thickness of 2".  
Price.....\$3.00

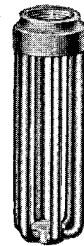

Type 69 Wire  
Bulb Guard,  
extra...\$4.00  
(Requires  
1 1/4" connec-  
tion.)

# American Schaeffer & Budenberg Division

## LIST PRICES

### Type 214

#### American Portable Long Stem Thermometers with Adjustable Clamp Flange or Prong Clamp Hook

*Prices Apply for any Temperature Range Not Exceeding 750° F., 400° C. or 320° R.*

*For temperature ranges over 750° F. but not exceeding 900° F., 480° C. or 385° R. add to list prices.....Each \$5.00*

*For temperature ranges up to 950° F., 500° C. or 400° R., add to list prices.....Each \$10.00*

Intermediate length stems take next higher lists.

Stem Length	Size of Scale	
	9 inch	12 inch
6 inch	\$17.50	\$21.00
12 inch	19.50	23.00
18 inch	21.50	25.00
24 inch	23.50	27.00
30 inch	25.50	29.00
36 inch	27.50	31.00
42 inch	29.50	33.00
48 inch	31.50	35.00

### Type 216

#### American Portable Thermometer with Prong Clamp Hook or Adjustable Clamp Flange

*Prices Apply for any Temperature Range Not Exceeding 750° F., 400° C. or 320° R.*

Stem Length	Size of Scale	
	7 inch	10 inch
12 inch	\$18.00	\$21.00
14 inch	19.00	22.00
18 inch	20.00	23.00
24 inch	22.00	25.00
30 inch	24.00	27.00
36 inch	26.00	29.00
42 inch	28.00	31.00
48 inch	30.00	33.00

All prices are subject to discount.

*For extremely accurate reading, the glass tubes may be etched to correspond with the metal scale at an extra charge of \$3.00 list.*

*A Factory Test Certificate will be issued with any of the above thermometers when requested, at no extra charge.*



Standardized American Long Stem Thermometers for Specific Applications

American Oil Temper  
Bath Thermometer

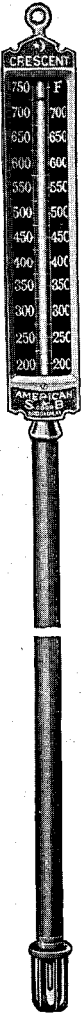

Type 215  
Code Word—  
LBAE

An extra sensitive thermometer for testing the temperature of oil used for tempering baths. Made in a 12" aluminum case, glass front, with ring for hanging. Scale graduated 200 to 750°. Stem 24" long and made with exposed copper plated Bulb and a heavy Bulb Guard.  
Price ..... \$31.00

American Platform  
or Milk Testing  
Thermometer



Type 218  
Code word—  
LBAH

For the testing of cold milk as it is delivered to the receiving platform of the pasteurizing or distributing station, 7" aluminum case, glass front, handle top with ring for hanging, scale graduated 0-90° F., 18" stem, of Benedict nickel with Monel Metal Bulb Chamber. Safe to 212° F.  
Price..... \$20.00

American Thermometer  
for Batch Pasteurizers,  
Holding Vats, etc.



Type 220  
Code word—  
LBBJ

For the testing of Milk temperatures in Batch Pasteurizers, Holding Vats, etc. 10" aluminum case, glass front, ring on top of case, for hanging, handle directly under scale case for convenient handling. Scale graduated 60 to 160° F. 24" stem, of Benedict nickel with Monel Metal Bulb Chamber. Safe to 212° F.  
Price.....\$25.50

For other stem lengths see pages 214 and 215.

For extremely accurate reading, the glass tubes may be etched to correspond with the metal scale at an extra charge of \$3.00 list.

A Factory Test Certificate will be issued with any of the above thermometers when requested, at no extra charge.

# American Schaeffer & Budenberg Division

American  
Brine Tank  
Thermometer

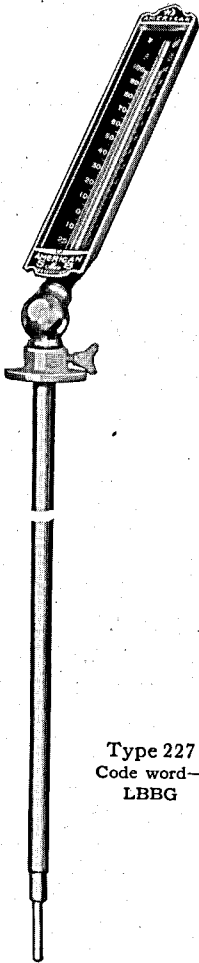

Type 227  
Code word—  
LBBG

American  
Varnish  
Thermometer

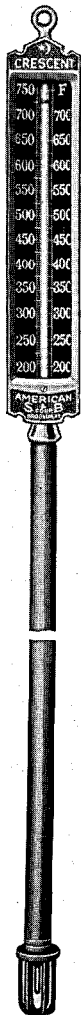

Type 228  
Code word—  
LBBH

American  
Molten Metal  
Thermometer

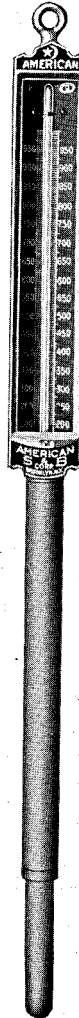

Type 230  
Code word—  
LBCJ

American  
Flue Gas  
Thermometer

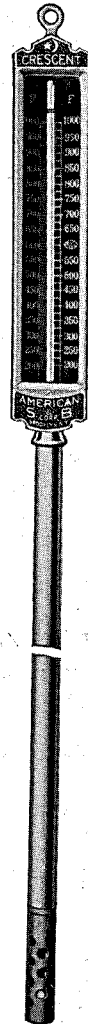

Type 232  
Code word—  
LBCB

For application to Brine Tanks. 12" Reclined nickel plated brass case, 45° angle, polished chromium plated front, glass front, scale graduated —20 to plus 120° F. in 1° subdivisions. 36" stem with adjustable brass flange for varying length of stem immersion.

Price.....\$33.50

Type 226 (Code word—LBBF)  
Straight Stem.....\$28.50

A supersensitive Thermometer for testing temperatures in Varnish Kettles, 12" aluminum case, glass front, ring for hanging. Scale graduated 200–750° F. Stem 36" long, with exposed copper plated Bulb and a heavy Bulb Guard.

For the greatest accuracy, the depth of immersion of the stem should be stated.

Price.....\$29.50

For measuring temperature of Electrottype Metal Pots, Solder Pots, Galvanizing Baths, etc. 12" aluminum case, glass front, ring for hanging. Scale graduated 200–750° F. or 200–950° F. 18" long, Cast Iron Stem. With scale graduated 200–750° F.

Price.....\$30.00  
With scale graduated 200–950° F.....\$40.00  
Furnished only in this stem length.

For determining Flue Gas Temperatures. 12" aluminum case, glass front, ring on top for hanging. Scale graduated 200–950° F. Steel stem 30" long, with adjustable flange.

Price.....\$39.00

Type 233 Angle Form..\$42.00

For other stem lengths see pages 214 and 215.

For extremely accurate reading, the glass tubes may be etched to correspond with the metal scale at an extra charge of \$3.00 list.

A Factory Test Certificate will be issued with any of the above thermometers when requested, at no extra charge.

All prices are subject to discount.

## American Long Stem Thermometers Angle Form

**T**YPE 234 American Long Stem Angle Thermometer is adapted for installations where it is necessary to extend the stem for some distance into the apparatus to which the Thermometer is attached.

*With 7, 9 or 12 inch scale. Any range up to 950° F.*

Standard Stem is of Bronze with Monel Metal Bulb Chamber—will not bind in Socket. Steel Stems furnished to special order.

On pages 220 and 221 are illustrated and described several types of Angle Thermometers standardized for application to Air Ducts, Ovens, Cold Storage Rooms, and Pasteurizers.

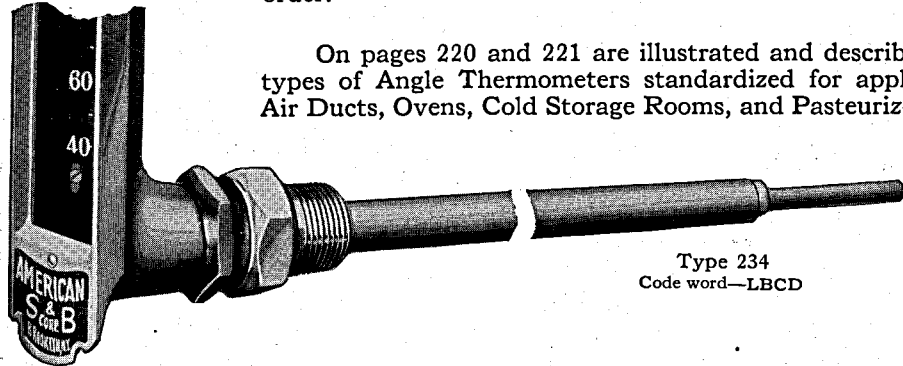

Type 234  
Code word—LBCD

### LIST PRICES

#### Type 234 American Long Stem Angle Thermometer

*Prices Apply for Any Temperature Range Not Exceeding 750° F., 400° C. or 320° R.*

*For temperature ranges over 750° F., but not exceeding 900° F., 480° C. or 385° R. add to list prices. .Each \$5.00*

*For temperature ranges up to 950° F., or 500° C. or 400° R. add to list prices. . . .Each \$10.00.*

Intermediate length stems take next higher lists.

Stem Length Including Thread	CONNECTION								
	Fixed or Plain			Union			Separable Socket		
	Size of Scale Case			Size of Scale Case			Size of Scale Case		
	7 inch	9 inch	12 inch	7 inch	9 inch	12 inch	7 inch	9 inch	12 inch
6 inch	\$17.00	\$20.50	\$24.00	\$20.00	\$23.50	\$27.00	\$23.00	\$26.50	\$30.00
12 inch	19.00	22.50	26.00	22.00	25.50	29.00	27.00	30.50	34.00
18 inch	21.00	24.50	28.00	24.00	27.50	31.00	31.00	34.50	38.00
24 inch	23.00	26.50	30.00	26.00	29.50	33.00	35.00	38.50	42.00
30 inch	25.00	28.50	32.00	28.00	31.50	35.00	39.00	42.50	46.00
36 inch	27.00	30.50	34.00	30.00	33.50	37.00	43.00	46.50	50.00
48 inch	.....	34.50	38.00	.....	37.50	41.00	.....	54.50	58.00
60 inch	.....	38.50	42.00	.....	41.50	45.00	.....	62.50	66.00

$\frac{3}{4}$ " Standard Pipe Thread is standard on Thermometers with stems up to and including 6". 1" Standard Pipe Thread can be supplied to order without extra charge. 1" Standard Pipe Thread is standard for Thermometers with stem longer than 6".  $\frac{3}{4}$ " Standard Pipe Thread can be supplied to order (on Fixed and Union Connection Thermometers only) without extra charge. Extra charge for  $1\frac{1}{4}$ " connection, \$3.50;  $1\frac{1}{2}$ " \$4.00.

*Union Connection prices include Union Bushing or  $\frac{3}{4}$ " Union Flange.  
Separable Socket prices include Socket. Sockets longer than 6" are of Drawn Bronze Tubing or Steel Tubing.*

*For Straight Types see pages 212 and 213.*

*For Inclined and Reclined Scale Types see pages 228 and 229.*

*Prices of extra Separable Sockets and Sockets of special material to withstand corrosion on pages 232 and 233. Prices of Bushings on page 230.*

*For Side Angle and Oblique Angle Types see pages 219 and 226.*

*For Extension Neck Types, see pages 224 and 225.*

*For extremely accurate reading, the glass tubes may be etched to correspond with the metal scale at an extra charge of \$3.00 list.*

*A Factory Test Certificate will be issued with any of the above thermometers when requested, at no extra charge.*

## Left or Right Side Angle Forms American Thermometers

With 7, 9 or 12 inch scale. Any range up to 950° F.

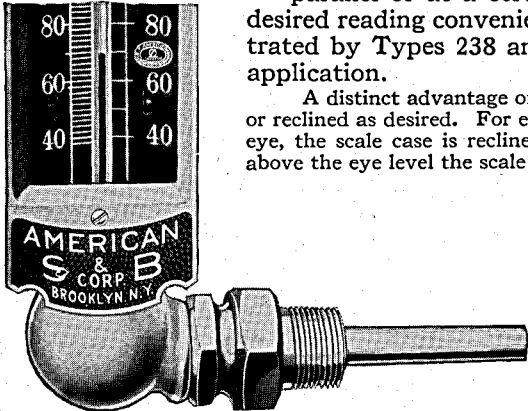

Type 236  
Right Side Angle  
Code word—LBCF

IT IS necessary or desirable, very often, when installing the Thermometer to the side of pipes or other apparatus, to face the scale case in direct parallel or at a certain angle to the Thermometer stem to secure the desired reading convenience. Left or Right Side Angle Thermometers illustrated by Types 238 and 236 respectively, are specially designed for such application.

A distinct advantage of the Side Angle feature is that the scale case may be inclined or reclined as desired. For example, if the Thermometer is installed below the level of the eye, the scale case is reclined sufficiently to obtain reading convenience and if installed above the eye level the scale case is inclined when inserting Thermometer.

Bulb Chambers are of Monel Metal (non-corrosive and will not bind in Socket). Stem extensions are of Bronze.

With 7, 9 or 12 inch scale. Any range up to 950° F.

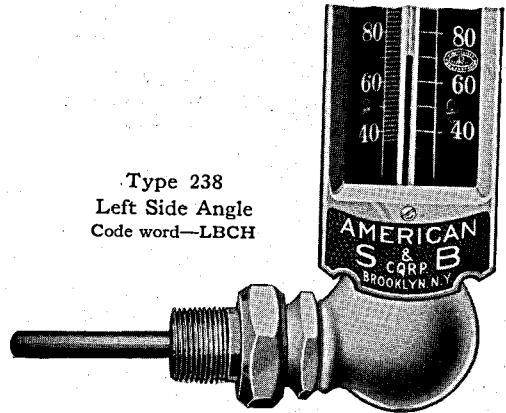

Type 238  
Left Side Angle  
Code word—LBCH

### List Prices of Types 236 and 238 Thermometers

Prices Apply for Any Temperature Range Not Exceeding 750° F., 400° C. or 320° R.

For temperature ranges over 750° F., but not exceeding 900° F., 480° C. or 385° R., add to list prices... Each \$5.00

For temperature ranges up to 950° F., 500° C. or 400° R., add to list prices... Each \$10.00

Intermediate length stems take next higher lists.

Stem Length Including Thread	CONNECTION					
	Union			Separable Socket		
	Size of Scale			Size of Scale		
	7 inch	9 inch	12 inch	7 inch	9 inch	12 inch
3½ inch (Std.)	\$20.50	\$24.00	\$27.50	\$23.50	\$27.00	\$30.50
6 inch	22.00	25.50	29.00	25.00	28.50	32.00
12 inch	24.00	27.50	31.00	29.00	32.50	36.00
18 inch	26.00	29.50	33.00	33.00	36.50	40.00
24 inch	28.00	31.50	35.00	37.00	40.50	44.00
30 inch	30.00	33.50	37.00	41.00	44.50	48.00
36 inch	32.00	35.50	39.00	45.00	48.50	52.00
48 inch	.....	39.50	43.00	.....	56.50	60.00
60 inch	.....	43.50	47.00	.....	64.50	68.00

¾" Standard Pipe Thread is standard on Thermometers with stems up to and including 6". 1" Standard Pipe Thread can be supplied to order without extra charge. 1" Standard Pipe Thread is standard for Thermometers with stem longer than 6". ¾" Standard Pipe Thread can be supplied to order (on Fixed and Union Connection Thermometers only) without extra charge. Extra charge for 1¼" connection, \$3.50; 1½", \$4.00.

Any American Angle Type Thermometer shown on preceding or succeeding pages can be fitted with Side Angle Feature at extra list charge of \$2.00.

For Extension Neck Types see Pages 224-225.

For extremely accurate reading, the glass tubes may be etched to correspond with the metal scale at an extra charge of \$3.00 list.

A Factory Test Certificate will be issued with any of the above thermometers when requested, at no extra charge.

## Standardized Long Stem Angle Types American Thermometers for Specific Applications

### Air Duct

**T**YPE 240 American Air Duct Thermometer is designed for application to all heating and ventilating Ducts. "V" shaped case with chromium plated frame. 9 or 12" scale, graduated 0-160° F. Stem of required length with exposed mercury chamber and perforated guard. Fitted with Union Connection and 3½ inch Union Flange. (Flange not drilled unless so ordered.)

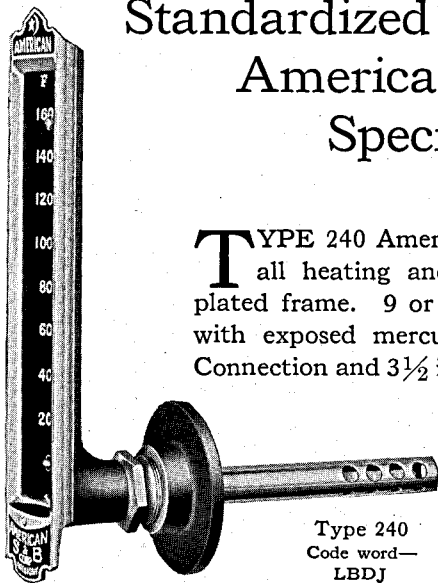

Type 240  
Code word—  
LBDJ

### LIST PRICES

	9" Scale	12" Scale
With stem 6" long.....	\$23.50	\$27.00
With stem 12" long.....	25.50	29.00
When longer stem length is desired add \$2.00 for each 6" or fraction thereof.		

### Bakers' Oven

**T**YPE 244 American Thermometer is commonly used on bakers' ovens, etc. "V" shaped case with chromium plated frame, 9 or 12" scale graduated 200 to 750° F. Other ranges to order. Plain stem (no thread connection) of required length with exposed mercury chamber, perforated guard and adjustable clamp Flange.

### LIST PRICES

	9" Scale	12" Scale
With stem 30" long.....	\$26.50	\$30.00

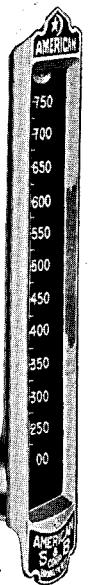

Type 244  
Code word—LBDD

### Enamelling, Japanning, Tempering and Core Oven

Nickel plated "V" shaped case with chromium plated frame, 9 or 12" scale graduated 50 to 500° F. (other ranges to order) 6" stem measured from end of fitting with exposed mercury chamber and perforated bulb guard. Fixed flange, running thread wall fitting with washer and locknut. (Standard fitting for wall 2½" thick or less. For walls thicker than 2½", use Type 240.)

### LIST PRICES

Type 242 Oven Thermometer with	
9" Scale.....	\$25.50
12" Scale.....	29.00
For Flue Gas Thermometers see page 217, Type 232.	

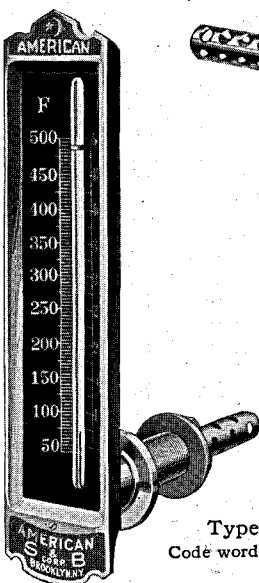

Type 242  
Code word—LBDB

For extremely accurate reading, the glass tubes may be etched to correspond with the metal scale at an extra charge of \$3.00 list.

A Factory Test Certificate will be issued with any of the above thermometers when requested, at no extra charge.

# American Schaeffer & Budenberg Division

## Cold Storage

**S**PECIALLY designed for indicating cold storage room temperatures. "V" shaped case with chromium plated frame and glass front, 9" or 12" scale graduated - 10 to + 70° F. (other graduations to order). Special insulating wall fitting and stem approximately 8" from end of fitting. When ordering state exact thickness of wall.

### LIST PRICES

Type 246 American Cold Storage Thermometer

	9" Scale	12" Scale
With fitting for walls up to 6" thick.....	\$29.50	\$33.00
When stem length longer than 8" is desired beyond fitting, add \$2.00 for each 6" or fraction thereof.		

For walls over 6" thick, add \$2.00 for each additional 6" or fraction thereof.

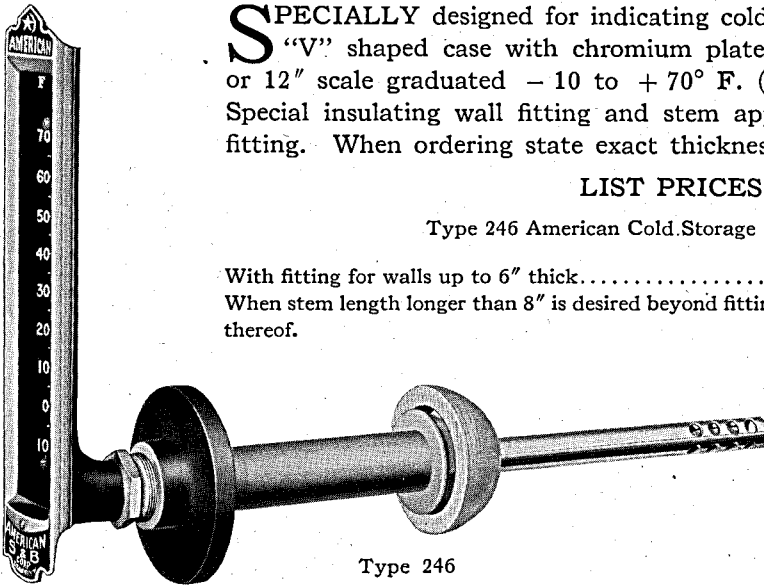

Type 246  
Code word—LBDF

## Pasteurizer

### With International Standard Sanitary Fitting

Adapted for Batch Pasteurizers, Holding Vats, Coolers, Storage Vats, Cream Ripeners, etc.

Used extensively on Cherry Vat Pasteurizer, Creamery Package Wizard Vat Pasteurizer and Reid Vat Pasteurizer.

Furnished in chromium plated "V" shaped case with glass front, 9" scale, graduated 60-160° F. (in 1° subdivision,  $\frac{1}{8}$ " wide), and made safe for 220° F. Can be fitted with standard sanitary fitting, union connection, monel bulb chamber. Fitting is fully nickel-plated.

### LIST PRICES

	Left or Right	
	Regular Angle	Side Angle
With 9" scale.....	\$23.50	\$25.50
Standard Sanitary fitting, extra.....		\$7.00

In apparatus of vertical coil type where Thermometer is mounted through the top, Standard Long Stem Thermometer with Extension Neck (page 222) and union bushing, with white enameled case and nickel-plated stem is used.

For extremely accurate reading, the glass tubes may be etched to correspond with the metal scale at an extra charge of \$3.00 list.

A Factory Test Certificate will be issued with any of the above thermometers when requested, at no extra charge.

### NOTE

The stem of this Thermometer is specially constructed for use with the approved standard sanitary vat fitting. If your apparatus is already equipped with this fitting, your order should specify "Type 277 Thermometer without fitting."

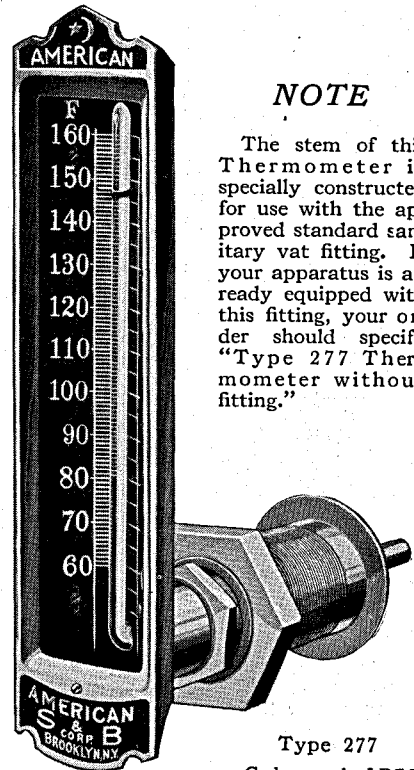

Type 277  
Code word—LBGG

## Extension Neck Types American Thermometers

### Straight Forms

**T**HESE Thermometers are designed for application to insulated steam and hot water pipes, tanks, etc., when the extension neck between the thread and hexagon permits the penetration and clearing of pipe covering, lagging, etc., thus bringing the scale case into clear vision. The hexagon being above the extension permits installing Thermometer without cutting away covering except for the hole to accommodate Thermometer stem. Specially adapted for application to Brine Pipes, Ammonia Pipes, and other Refrigerating Apparatus when the extension neck feature enables the clearing of the scale case above the usual coating of frost. When furnished for these latter applications, the Thermometer is regularly fitted with a hard rubber insulating ring bushing between the neck and connection as shown by illustration, thus eliminating the formation of frost on the scale of the Thermometer. For this type ask for 248A or 250A. There is no extra charge for the insulating bushing.

Type 250 is used when, in addition to penetrating insulation, it is necessary to extend the stem "S" into the tank or other apparatus for some distance.

Types 248 and 250 American Thermometers are supplied with either Union or Separable Socket Connection. Separable Socket Connection is recommended especially when used in connection with refrigerating apparatus.

For Ammonia, Gas, etc., steel Separable Socket is recommended.

For superheated steam service a stainless steel separable socket with 1" connection is recommended.

For prices of steel and stainless steel separable sockets, see pages 232 and 233.

Standard Stem is of Bronze with Monel Metal Bulb Chamber.

The extension neck may be had in two standard sizes: with dimensions "A"  $1\frac{3}{4}$  or  $2\frac{1}{2}$ ". Special extensions can also be furnished at prices listed opposite.

#### Reference Index

For Angle Forms of Types 248 and 250 Thermometers, see pages 224 and 225. Prices of extra bushings and sockets on pages 230 to 233.

#### American Thermometers Are Easy To Read!

For all temperatures up to 750° F. or equivalent, mercury filled Red Reflecting tubes are used. With these tubes, the mercury appears as a broad red stripe.

For temperatures above 750° F. or equivalent Boro Silicate glass is used.

With 7, 9 or 12 inch scale. Any range up to 950° F.

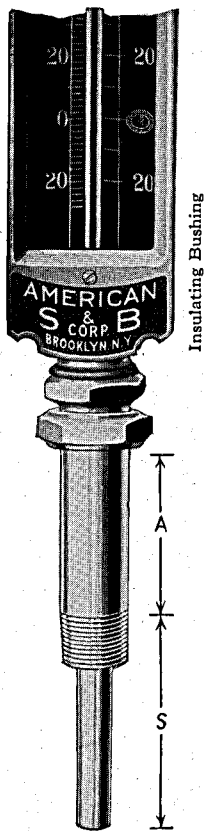

Type 248A

Showing Separable Socket Connection and Separable Socket and Insulating Bushing.

Without Insulating Bushing, Type 248.

Code word—LBDH

With 7, 9 or 12 inch scale. Any range up to 950° F.

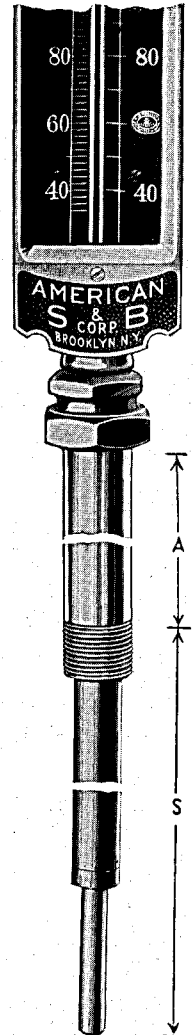

Type 250  
Showing Union Connection and Union Bushing.

Code word—LBEJ

# American Schaeffer & Budenberg Division

## List Prices

Prices Apply for Any Temperature Range Not Exceeding 750° F., 400° C. or 320° R.

For temperature ranges over 750° F. but not exceeding 900° F., 480° C. or 385° R., add to list prices. . . Each \$5.00

For temperature ranges up to 950° F., or 500° C. or 400° R., add to list prices. . . . Each \$10.00

### Type 248 and 248A American Extension Neck Thermometer

With Extension "A" either 1 $\frac{3}{4}$ " or 2 $\frac{1}{2}$ " long and Stem "S" 3 $\frac{1}{2}$ " long, including Thread.

Size of Scale	CONNECTION	
	Union Including Union Bushing	Separable Socket, Including Standard Socket
	Price Each	Price Each
7 inch	\$17.00	\$21.00
9 inch	20.50	24.50
12 inch	24.00	28.00

### Type 250 American Combination Extension Neck and Stem Thermometer

With Extension "A" either 1 $\frac{3}{4}$ " or 2 $\frac{1}{2}$ " long  
Intermediate length stems take next higher lists.

Length of Stem "S" Including Thread	CONNECTION					
	Union			Separable Socket		
	Size of Scale Case			Size of Scale Case		
	7 inch	9 inch	12 inch	7 inch	9 inch	12 inch
6 inch	\$18.50	\$22.00	\$25.50	\$22.50	\$26.00	\$29.50
12 inch	20.50	24.00	27.50	26.50	30.00	33.50
18 inch	22.50	26.00	29.50	30.50	34.00	37.50
24 inch	24.50	28.00	31.50	34.50	38.00	41.50
30 inch	26.50	30.00	33.50	38.50	42.00	45.50
36 inch	28.50	32.00	35.50	42.50	46.00	49.50
48 inch	.....	36.00	39.50	.....	54.00	57.50
60 inch	.....	40.00	45.50	.....	62.00	65.50

For extension neck other than standard and with dimension "A" not exceeding 6", add to list prices as follows:—

Union Connection.....\$4.00  
Separable Socket..... 5.00

For extension necks longer than 6" add to list prices (after adding charge for first 6" given above) for each additional 3" or fraction thereof.

Union Connection.....\$2.00  
Separable Socket..... 3.00

$\frac{3}{4}$ " Standard Pipe Thread is standard on Thermometers with stems up to and including 6". 1" Standard Pipe Thread can be supplied to order without extra charge. 1" Standard Pipe Thread is standard for Thermometers with stem longer than 6".  $\frac{3}{4}$ " Standard Pipe Thread can be supplied to order (on Fixed and Union Connection Thermometers only) without extra charge. Extra charge for 1 $\frac{1}{4}$ " connection, \$3.50; 1 $\frac{1}{2}$ ", \$4.00.

Union Connection prices include Union Bushing.

Separable Socket prices include Socket. Sockets longer than 6 inches are of Drawn Bronze Tubing or Steel Tubing.

For Sockets of special material to withstand corrosion, etc., see pages 230 and 233.

For Angle Forms, see following page.

For extremely accurate reading, the glass tubes may be etched to correspond with the metal scale at an extra charge of \$3.00 list.

A Factory Test Certificate will be issued with any of the above thermometers when requested, at no extra charge.



With 7, 9 or 12 inch scale. Any range up to 950° F.

## Extension Neck Types American Thermometers

Angle Forms

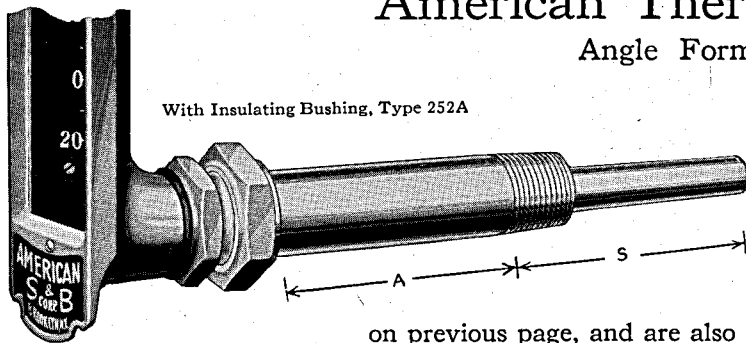

With Insulating Bushing, Type 252A

Type 252

Code word—LBEB

**T**YPES 252 and 254 American Thermometers are the Angle Forms of Types 248 and 250 Thermometers shown

on previous page, and are also designed for application to insulated steam and hot water pipes, tanks, etc., when the extension neck between the thread and hexagon permits the penetration and clearing of pipe covering, lagging, etc., thus bringing the scale case into clear vision. The hexagon being above the extension permits installing Thermometer without cutting away covering except for the hole to accommodate Thermometer stem. Specially adapted, as well, for application to Brine Pipes, Ammonia Pipes and other Refrigerating apparatus when the extension neck feature enables the clearing of the scale case from the usual coating of frost. For these latter applications the Thermometer is regularly equipped with a hard rubber insulating bushing fitted between the neck and connection, thus eliminating the formation of frost on the scale of the Thermometer. With the insulating bushing, Type 252A or Type 254A should be specified.

Type 254 is used, when, in addition to penetrating insulation it is necessary to extend the stem "S" into the tank or other apparatus for some distance.

Types 252 and 254 American Thermometers are supplied with either Union or Separable Socket Connection. Separable Socket Connection is recommended especially when used in connection with Refrigerating apparatus.

For Ammonia, Gas, etc., steel separable socket is recommended. For superheated steam service a stainless steel separable socket with 1" connection is recommended. For prices, see pages 236 and 237. Standard Stem is of Bronze with Monel Metal Bulb Chamber.

The extension neck may be had in two standard sizes: with dimension "A"  $1\frac{3}{4}$ " or  $2\frac{1}{2}$ ". Special extensions can also be furnished at prices listed opposite.

With 7, 9 or 12 inch scale. Any range up to 950° F.

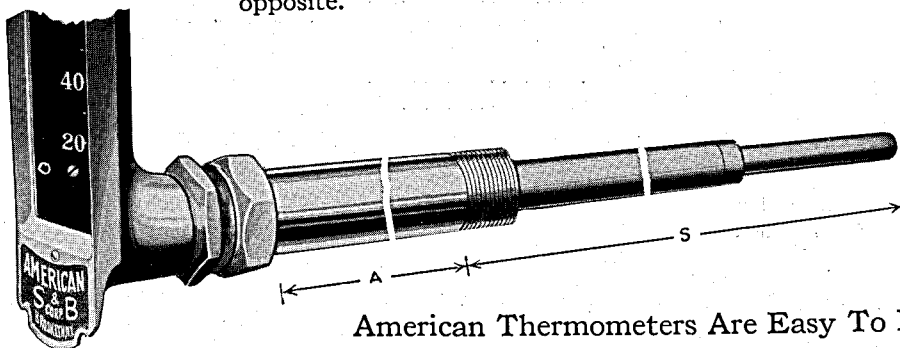

Type 254

Code word—LBED

**American Thermometers Are Easy To Read!**

For all temperatures up to 750° F. or equivalent, mercury filled Red Reflecting tubes are used. With these tubes, the mercury appears as a broad red stripe.

For temperatures above 750° F. or equivalent Boro Silicate glass is used.

# American Schaeffer & Budenberg Division

## List Prices

Prices Apply for Any Temperature Range Not Exceeding 750° F., 400° C. or 320° R.

For temperature ranges over 750° F. but not exceeding 900° F., 480° C. or 385° R., add to list prices. . . . Each \$5.00

For temperature ranges up to 950° F., 500° C. or 400° R., add to list prices. . . . . Each \$10.00

Type 252 American  
Extension Neck Thermometer  
With Extension "A" either 1 $\frac{3}{4}$ " or 2 $\frac{1}{2}$ " long and Stem "S" 3 $\frac{1}{2}$ " long

Size of Scale	CONNECTION	
	Union, Including Union Bushing	Separable Socket, Including Standard Socket
	Price Each	Price Each
7 inch	\$20.00	\$24.00
9 inch	23.50	27.50
12 inch	27.00	31.00

If required Side Angle, add \$2.00 to list.

Type 254 American  
Combination Extension Neck and Stem Thermometer  
With Extension "A" either 1 $\frac{3}{4}$ " or 2 $\frac{1}{2}$ " long  
Intermediate length stems take next higher lists.

Length of Stem "S" Including Thread	CONNECTION					
	Union			Separable Socket		
	Size of Scale Case			Size of Scale Case		
	7 inch	9 inch	12 inch	7 inch	9 inch	12 inch
6 inch	\$21.50	\$25.00	\$28.50	\$25.50	\$29.00	\$32.50
12 inch	23.50	27.00	30.50	29.50	33.00	36.50
18 inch	25.50	29.00	32.50	33.50	37.00	40.50
24 inch	27.50	31.00	34.50	37.50	41.00	44.50
30 inch	29.50	33.00	36.50	41.50	45.00	48.50
36 inch	31.50	35.00	38.50	45.50	49.00	52.50
48 inch	.....	39.00	42.50	.....	57.00	60.50
60 inch	.....	43.00	46.50	.....	65.00	68.50

For extension neck other than standard and with dimension "A" not exceeding 6", add to list prices as follows:—

Union Connection.....\$4.00  
Separable Socket..... 5.00

For extension necks longer than 6", add to the above prices, (after adding charge for first 6" given above) for each additional 3" or fraction thereof.

Union Connection.....\$2.00  
Separable Socket..... 3.00

$\frac{3}{4}$ " Standard Pipe Thread is standard on Thermometers with stems up to and including 6". 1" Standard Pipe Thread can be supplied to order without extra charge. 1" Standard Pipe Thread is standard for Thermometers with stem longer than 6".  $\frac{3}{4}$ " Standard Pipe Thread can be supplied to order (on Fixed and Union Connection Thermometers only) without extra charge. Extra charge for 1 $\frac{1}{4}$ " connection, \$3.50; 1 $\frac{1}{2}$ ", \$4.00.

Union Connection prices include Union Bushing.

Separable Socket prices include Socket. Sockets longer than 6 inches are of Drawn Bronze Tubing or Steel Tubing.

For sockets of special material to withstand corrosion, etc., see pages 230 and 233.

For extremely accurate reading, the glass tubes may be etched to correspond with the metal scale at an extra charge of \$3.00 list.

A Factory Test Certificate will be issued with any of the above thermometers when requested, at no extra charge.

# Oblique Stem Types American Thermometers

With 7, 9 or 12 inch scale. Any range up to 950° F.

With 7, 9 or 12 inch scale. Any range up to 950° F.

When Ordering Specify Desired Stem Angle from Diagrams Below

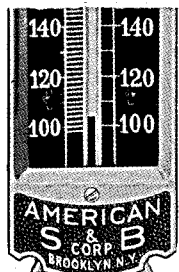

Type 256  
Right Side Angle  
Oblique Stem.  
Code word—LBEF

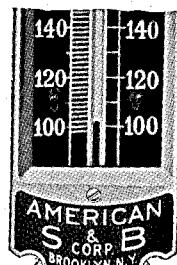
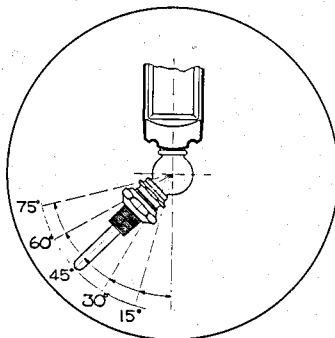

Type 258  
Left Side  
Angle Ob-  
lique Stem.  
Code word—  
LBEH

With 7, 9 or 12 inch scale. Any range up to 950° F.

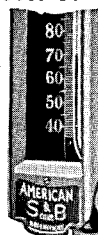

Type 260  
Regular  
Angle Ob-  
lique Stem.  
Code word—  
LBFJ

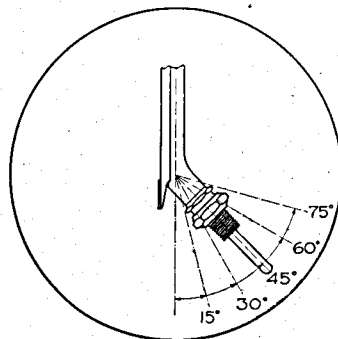
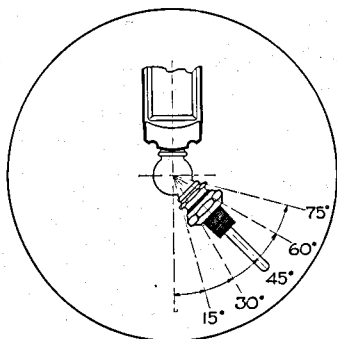

# American Schaeffer & Budenberg Division

## Oblique Stem Types American Thermometers

**T**HE Oblique Stem Type American Thermometer is intended principally for installations where it is necessary to extend the stem and sensitive bulb a distance in and towards the bottom of the apparatus as well as for installation where stationary or moving obstructions must be cleared, for example, pipe coils, agitators, etc.

Equipped with stem at any angle as shown. When ordering be careful to specify the desired angle. Otherwise Thermometer with stem at standard angle of 45° such as shown by illustrations will be furnished.

For Temperatures up to 750° F. Standard Stem is of Bronze with Monel Metal Bulb Chamber for higher temperatures a steel stem is used.

### LIST PRICES

#### Types 256-258 and 260 American Thermometers

Prices Apply for Any Temperature Range Not Exceeding 750° F., 400° C. or 320° R.

For temperature ranges over 750° F., but not exceeding 900° F., 480° C. or 385° R. add to list prices. . . Each \$5.00

For temperature ranges up to 950° F., 500° C. or 400° R. add to list prices. . . . . Each \$10.00

Intermediate length stems take next higher lists.

Stem Length Including Thread	CONNECTION					
	Union			Separable Socket		
	Size of Scale			Size of Scale		
	7 inch	9 inch	12 inch	7 inch	9 inch	12 inch
3½ inch (Std.)	\$20.50	\$24.00	\$27.50	\$23.50	\$27.00	\$30.50
6 inch	22.00	25.50	29.00	25.00	28.50	32.00
12 inch	24.00	27.50	31.00	29.00	32.50	36.00
18 inch	26.00	29.50	33.00	33.00	36.50	40.00
24 inch	28.00	31.50	35.00	37.00	40.50	44.00
30 inch	30.00	33.50	37.00	41.00	44.50	48.00
36 inch	32.00	35.50	39.00	45.00	48.50	52.00
48 inch	.....	39.50	43.00	.....	56.50	60.00
60 inch	.....	43.50	47.00	.....	64.50	68.00

If Thermometer is required with Extension Neck or Combination Extension Neck and Stem same can be supplied at prices listed on page 225 plus \$2.00 list.

¾" Standard Pipe Thread is standard on Thermometers with stems up to and including 6". 1" Standard Pipe Thread can be supplied to order without extra charge. 1" Standard Pipe Thread is standard for Thermometers with stem longer than 6". ¾" Standard Pipe Thread, can be supplied to order (on Fixed and Union Connection Thermometers only) without extra charge. Extra charge for 1¼" connection, \$3.50; 1½", \$4.00.

Union Connection prices include Union Bushing or Type 74 or 75 Union Flange.

Separable Socket prices include Socket. Sockets longer than 6 inches are of Drawn Bronze Tubing or Steel Tubing. For Sockets of special material to withstand corrosion, etc., see pages 232 and 233.

Prices of extra Bushings and Sockets on pages 230 to 233.

For extremely accurate reading, the glass tubes may be etched to correspond with the metal scale at an extra charge of \$3.00 list.

A Factory Test Certificate will be issued with any of the above thermometers when requested, at no extra charge.

# Inclined and Reclined Scale American Thermometers

With 7, 9 or 12 inch scale. Any range up to 950° F.

Type 262  
Code word—  
LBFB

Reclined  
Scale

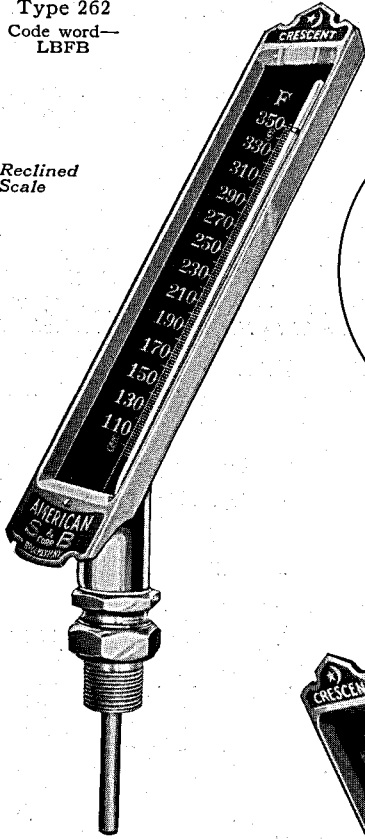

When Ordering Specify Angle or In-  
cline or Recline from Diagrams Below

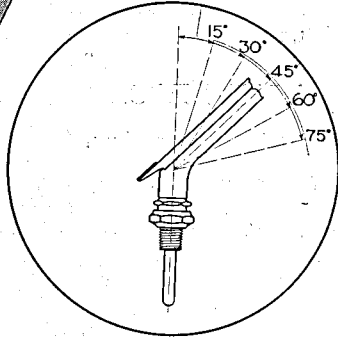

Type 264  
Code word—  
LBFD

Inclined  
Scale

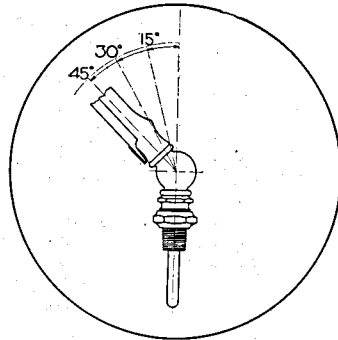
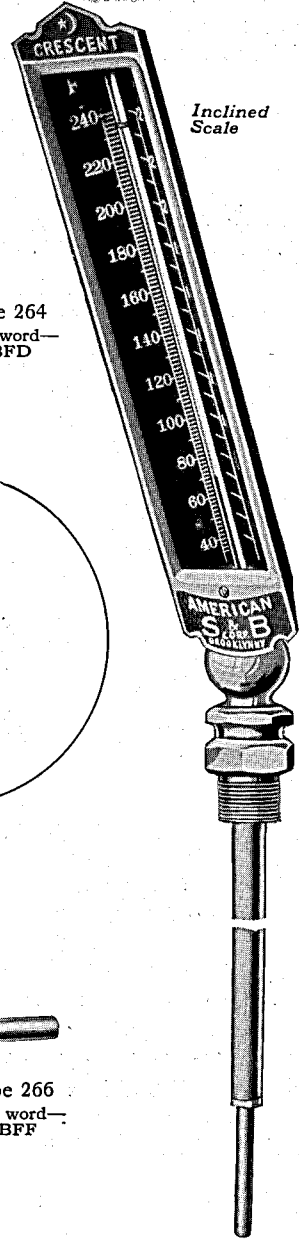

Type 266  
Code word—  
LBFF

Inclined  
Scale

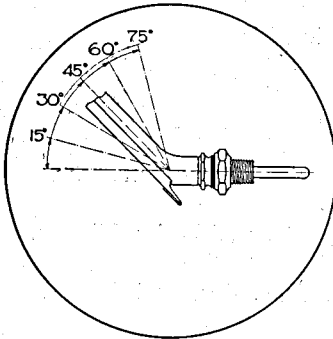

# American Schaeffer & Budenberg Division

## Inclined and Reclined Scale American Thermometers

**T**HE purpose of the Inclined Scale as illustrated by Types 264 and 266 is to effect reading convenience when the Thermometer is installed above the level of the eye.

When the Thermometer is installed below the eye level, reading convenience is secured by the use of Type 262 Reclined Scale Thermometer.

When ordering refer to the diagrams opposite and state desired angle of incline or recline.

Either Union or Separable Socket Connections recommended.

Monel Metal Bulb Chamber with Stem Extensions of Bronze up to 750° F. For higher temperatures steel stems are used.

### LIST PRICES

Types 262-264 and 266 American Thermometers

*Prices Apply for Any Temperature Range Not Exceeding 750° F., 400° C. or 320° R.*

*For temperature ranges over 750° F., but not exceeding 900° F., 480° C. or 385° R. add to list prices... Each \$5.00*

*For temperature ranges up to 950° F., 500° C. or 400° R. add to list prices... Each \$10.00*

Intermediate length stems take next higher lists.

Stem Length Including Thread	CONNECTION					
	Union			Separable Socket		
	Size of Scale			Size of Scale		
	7 inch	9 inch	12 inch	7 inch	9 inch	12 inch
3½ inch (Std.)	\$20.50	\$24.00	\$27.50	\$23.50	\$27.00	\$30.50
6 inch	22.00	25.50	29.00	25.00	28.50	32.00
12 inch	24.00	27.50	31.00	29.00	32.50	36.00
18 inch	26.00	29.50	33.00	33.00	36.50	40.00
24 inch	28.00	31.50	35.00	37.00	40.50	44.00
30 inch	30.00	33.50	37.00	41.00	44.50	48.00
36 inch	32.00	35.50	39.00	45.00	48.50	52.00
48 inch	.....	39.50	43.00	.....	56.50	60.00
60 inch	.....	43.50	47.00	.....	64.50	68.00

If Thermometer is required with Extension Neck or Combination Extension Neck and Stem same can be supplied at prices listed on page 225 plus \$2.00 list.

¾" Standard Pipe Thread is standard on Thermometers with stems up to and including 6". 1" Standard Pipe Thread can be supplied to order without extra charge. 1" Standard Pipe Thread is standard for Thermometers with stem longer than 6". ¾" Standard Pipe Thread can be supplied to order (on Fixed and Union Connection Thermometers only) without extra charge. Extra charge for 1¼" connection, \$3.50; 1½", \$4.00.

Union Connection prices include Union Bushing or Type 74 Union Flange.

Separable Socket prices include Socket. Sockets longer than 6 inches are of Drawn Bronze Tubing or Steel Tubing. For Sockets of special material to withstand corrosion, etc., see pages 232 and 233.

Prices of extra Bushings and Sockets on pages 230 to 233.

*For extremely accurate reading, the glass tubes may be etched to correspond with the metal scale at an extra charge of \$3.00 list.*

*A Factory Test Certificate will be issued with any of the above thermometers when requested, at no extra charge.*

## Union Bushings

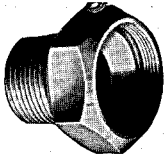

Type 68  
Code word—LFH

Type 68 Standard Union Bushing with  $\frac{3}{4}$ " or 1" Standard Pipe Thread.

No charge when furnished with Union Connection Thermometer.

Extra Bushings only. Each \$1.50

Extra Bushings with  $1\frac{1}{4}$ " Standard Pipe Thread. Each \$3.50

With  $1\frac{1}{2}$ " Standard Pipe Thread. Each \$4.00

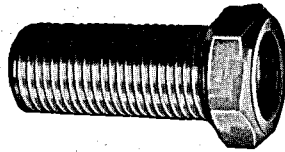

Type 82  
Code word—LHB

Type 82 Wood Thread Union Bushing,  $1\frac{1}{4}$ " or  $2\frac{1}{2}$ " long. For mounting Thermometer to Wood Tanks, etc. Extra charge when furnished in place of the Standard Bushing. Each.....\$3.00

Extra Bushings only. Each \$4.50

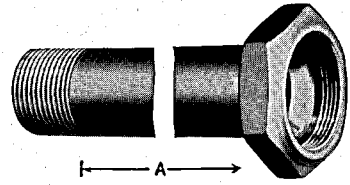

Type 80  
Code word—LHJ

Type 80 Extension Neck Union Bushing, for Pipes, Tanks, etc., when insulated with pipe covering, lagging, etc., or for Refrigerating Apparatus when covered with coating of frost. Standard extension,  $1\frac{1}{4}$ " or  $2\frac{1}{2}$ ". No charge when furnished with Union Connection. Types 248, 250, 252 and 254 Thermometers, Extra Standard Bushings only.....Each \$4.50  
Bushings with special extension not exceeding 6".....Each \$8.00  
Bushings with Extension Necks longer than 6" add for each additional 6" or fraction thereof.....\$2.00

## Wall Fittings

### Ventilated Fitting for Steam Jacketed Apparatus

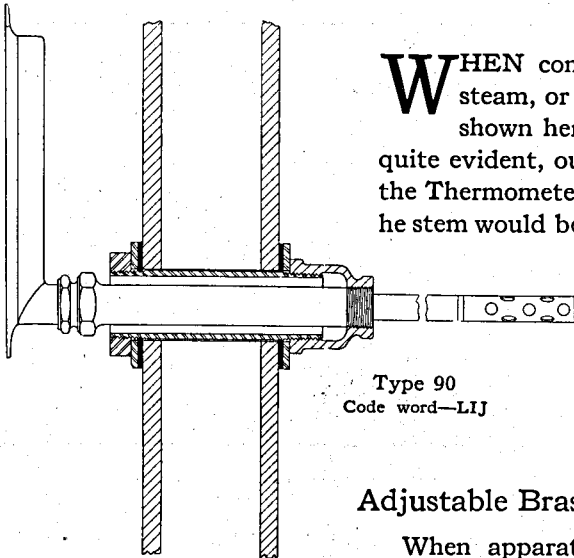

Type 90  
Code word—LIJ

**W**HEN connecting Thermometers to apparatus heated by steam, or hot air jacket, Type 90 Ventilated Wall Fitting shown here in application must be employed. For, as is quite evident, outside air must circulate around that portion of the Thermometer stem that passes through the jacket, otherwise the stem would be heated up too much causing incorrect readings.

When ordering this Fitting, state exact thickness of wall.

#### LIST PRICES

Type 90 Ventilated Fitting  
For walls up to 4".....\$12.00  
For walls up to 6"..... 14.00

### Adjustable Brass or Monel Metal Wall Fitting Bushing

When apparatus to which Bulb of Thermometer is to be attached does not permit of drilling to accommodate threaded connection Type 86 Adjustable Wall Fitting may be used. This Bushing is installed through hole drilled in apparatus and made tight by means of the locknut. Furnished for walls of any thickness as listed below.

#### LIST PRICES

	Brass	Monel Metal
For Walls up to 1" thick.....	\$4.50	\$10.00
For Walls up to 2" thick.....	6.00	13.00
For Walls up to 3" thick.....	7.00	15.00
For Walls up to 6" thick.....	8.00	17.00

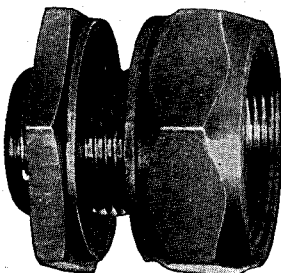

Type 86. Code word—LHF

# American Schaeffer & Budenberg Division

## Flanges

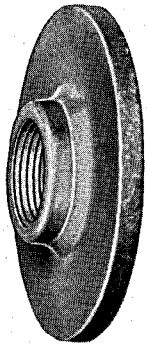

### Tapered Pipe Thread Flange

Used in connection with all fixed thread Thermometers. Furnished not drilled unless otherwise ordered.

#### LIST PRICES

Outside Diameter	Iron	Brass
3 1/2"	\$2.25	\$3.00
4 1/2"	2.50	4.00
6"	3.00	6.00

Type 76

Code word—LGF

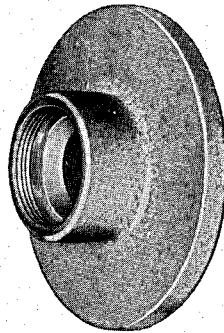

### Union Thread Flange

Used when required in place of the bushing on Union Connection Thermometers. Furnished not drilled unless otherwise ordered.

#### LIST PRICES

Outside Diameter	Iron	Brass
3 1/2"	\$2.75	\$3.50
4 1/2"	3.00	4.50
6"	3.50	6.00

Type 74

Code word—LGD

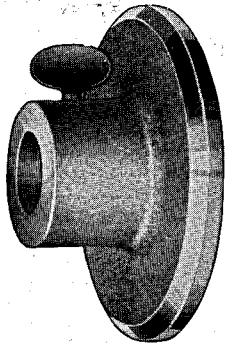

### Adjustable Flanges

For use in connection with Portable and other Thermometers not having thread connection.

#### LIST PRICES

		Iron	Brass
3" Type 73 Set Screw Flange		\$2.50	\$3.50

Type 73

Code word—LGC

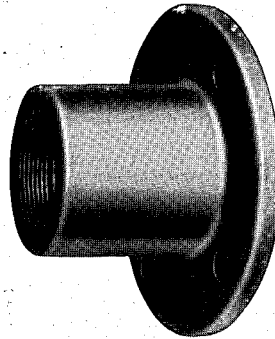

Extension neck union flange used for attaching thermometers to lagged air duct.

#### LIST PRICE

Outside Diameter	Extension from Bottom of Flange	Brass Only
3 1/2"	2"	\$5.00

Type 75

Code word—LGE

### Oblique Flange Union Thread

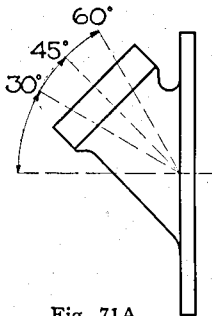
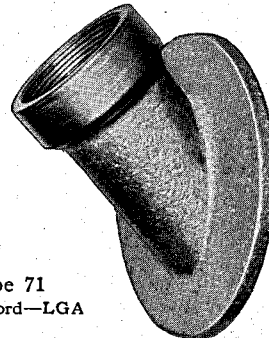

Fig. 71A



Type 71

Code word—LGA

Designed for use with Oblique Stem Union Connection Thermometers, shown on page 230. Furnished not drilled unless otherwise ordered. Supplied in three angles as shown by Fig. 71A.

#### LIST PRICES

Outside Diameter	Iron	Brass
3 1/2"	\$4.75	\$6.00
4 1/2"	5.50	7.50
6"	6.50	9.00



## Separable Sockets

### Standard Socket

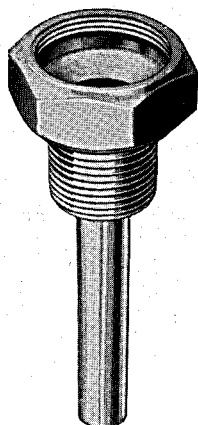

Type 30  
Code word—LCJ

**F**OR use with all types of American Thermometers having standard length bulb chamber ( $3\frac{1}{2}$ " including thread) and Separable Socket Connection.

#### LIST PRICES

$\frac{3}{4}$ " or 1" Standard Pipe Thread Connection ( $\frac{3}{4}$ " is standard)

Type 30 Socket of Brass (Standard)	Each.....	\$5.00
Type 30 Socket of Cast Iron	Each.....	6.00
Type 30 Socket of Steel	Each.....	5.00
Type 30 Socket of Monel Metal	} Prices on request.	
Type 30 Socket of Stainless Steel		

### Wood Thread Socket

When Thermometer is attached to Wood Tanks, Vats, etc., Type 38 Wood Thread Socket can be supplied. Furnished in Brass only at extra charge of \$9.00. Length of thread,  $2\frac{1}{2}$ ".

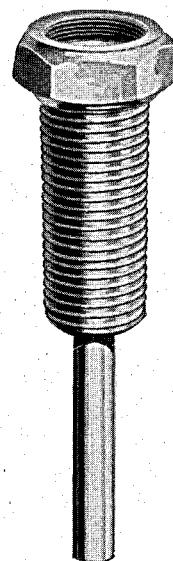

Type 38  
Code word—LCH

### Finned Sockets

For superheated steam, Sockets with fins similar to Thermometer Wells recommended in A. S. M. E. Power Test Code can be furnished if desired, in bronze up to  $700^{\circ}$  F. and in steel above  $700^{\circ}$  F. Prices on request.

### Sockets for Long Stem Thermometers

For use with all American Long Stem Thermometers having Separable Socket Connections.

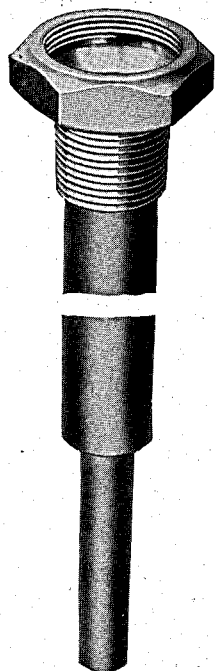

Type 32  
Code word—LCB

#### LIST PRICES

Length of Stem Including Thread	Standard Pipe Thread Connection	MATERIAL			
		Bronze or Steel Tube	Cast Iron	Solid Bored Steel	Solid Bored Monel Metal or Stainless Steel
6"	$\frac{3}{4}$ "	\$7.00*	\$12.00†	PRICES ON REQUEST	
12"	1"	8.00	20.00		
18"	1"	10.00			
24"	1"	12.00			
30"	1"	14.00			
36"	1"	16.00			
48"	1"	20.00			
60"	1"	24.00			

\*Made of solid brass only.

†Made with 1" Standard Pipe Thread only.

1" Standard Pipe Thread Connection can be supplied on 6" Socket without extra charge when so ordered.

Extra for  $1\frac{1}{4}$ " connection \$3.50;  $1\frac{1}{2}$ ", \$4.00.

1" N. P. T. connection is the smallest recommended for superheated steam service.

Sockets can be supplied with lead sleeves, porcelain acid proof enamel or tinned when so required. Prices on application.

When computing cost of Thermometer with other than Standard Socket, use Union Connection list prices, adding to same the cost of the Socket.

## Extension Neck Socket

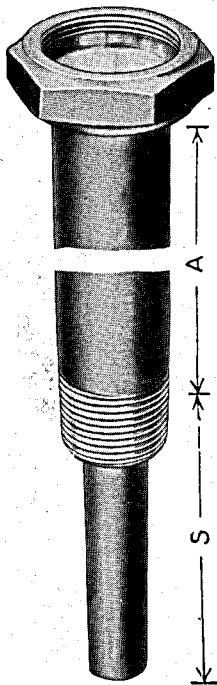

Type 34  
Code word—LCD

**F**OR use with Types 248 and 252 American Thermometers shown on pages 222 to 225, inclusive, having Separable Socket Connection.

### LIST PRICES

With extension "A" 1 3/4" or 2 1/2" long and stem "S" 3 1/2" including thread. 3/4" or 1" Standard Pipe Thread Connection (3/4" is standard).

Type 34 Socket of Brass (Standard)	Each.....	\$7.00
Type 34 Socket of Cast Iron	Each.....	8.00
Type 34 Socket of Steel	Each.....	7.00
Type 34 Socket of Monel Metal	} Prices on request.	
Type 34 Socket of Stainless Steel		

## Combination Extension Neck and Stem Socket

Used with Types 250 and 254 American Thermometers shown on pages 222 to 225 inclusive having Separable Socket Connection.

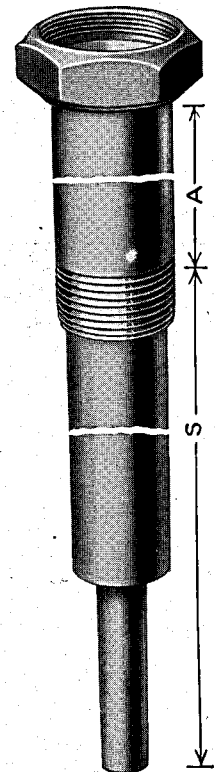

Type 36  
Code word—LCF

### LIST PRICES

With Extension "A" 1 3/4" or 2 1/2"

Length Stem "S" Including Thread	Standard Pipe Thread Connection	MATERIAL			
		Bronze or Steel Tube	Cast Iron	Solid Bored Steel	Solid Bored Monel Metal or Stainless Steel
6"	3/4"	\$ 9.50*	\$18.00†	PRICES ON REQUEST	
12"	1"	11.50	30.00		
18"	1"	13.50			
24"	1"	15.50			
30"	1"	17.50			
36"	1"	19.50			
48"	1"	23.50			
60"	1"	27.50			

\*Made of solid brass only.

†Made with 1" Standard Pipe Thread only.

For sockets with extension necks other than standard compute total length of Socket required, ("S" + "A") use price list of Type 32 long stem Socket on preceding page and add to same \$3.50 list.

1" Standard Pipe Thread Connection can be supplied on 6" Socket without extra charge when so ordered. Extra for 1 1/4" Connection, \$3.50; 1 1/2", \$4.00.

1" N. P. T. connection is the smallest recommended for superheated steam service.

When computing cost of Thermometer with other than Standard Socket, use Union Connection list prices adding to same the cost of the Socket.

## American Open Front Thermometers "V" Shaped, Nickel-plated Iron Case

Any Range up to 750° F.

**T**YPES 270 and 272 Thermometers have been designed to supply the demand for a low priced industrial Thermometer for general use. The Thermometer is patterned after our American Thermometer having either 7" or 9" "V" shaped scale, without glass front. It is furnished in nickel-plated iron case. The scales are silver with bold, black figures, and can be graduated for any temperature range not exceeding 750° F. or equivalent in C. or R.

Bulb Chambers are monel metal, on standard stem Thermometers. Long stem Thermometers are furnished with stem extensions of drawn bronze tubing with bulb chamber of steel, copper plated.

Equipped with Rigid or Union Connection and any length stem as enumerated in price list below.

### LIST PRICES

For temperature ranges up to 650° F. or corresponding degrees C. or R.

For temperature ranges over 650° F. but not exceeding 750° F. or corresponding degrees C. or R. add \$2.50.

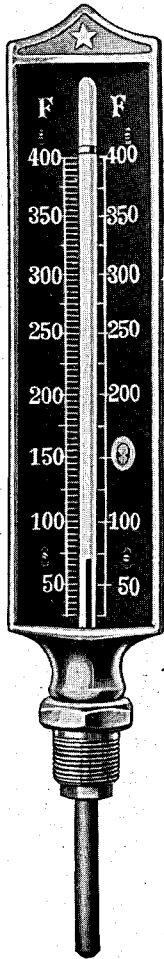

Type 270  
Code word—LBGJ

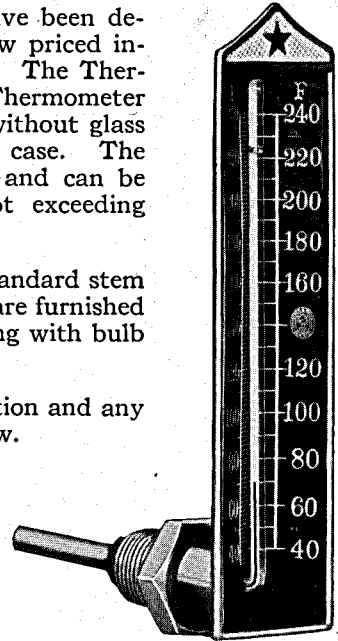

Type 272  
Code word—LBGB

Stem Length Including Thread	CONNECTION									
	Fixed				Union					
	Size of Scale Case				Size of Scale Case					
	7 inch	9 inch	7 inch	9 inch	7 inch	9 inch	7 inch	9 inch		
	Type 270			Straight Stem			Type 272		Angle Stem	
3½ inch (Std.)	\$ 9.00	\$10.00	\$12.00	\$13.00	\$11.00	\$12.00	\$14.00	\$15.00		
6 inch	11.00	12.00	14.00	15.00	13.00	14.00	16.00	17.00		
12 inch	13.00	14.00	16.00	17.00	15.00	16.00	18.00	19.00		

Standard Stem Length is 3½" including thread.

Intermediate length stems take next higher lists.

¾" Standard Pipe Thread connection is standard and is furnished with both Fixed Thread and Union Connection Thermometers having stems up to 6". ½" Standard Pipe Thread connection can be supplied with Fixed Thread Connection Thermometers when so ordered.

Stems longer than 6" are furnished with 1" Standard Pipe Thread connection.

### American Thermometers Are Easy To Read!

For all temperatures up to 750° F. or equivalent, mercury filled Red Reflecting tubes are used. With these tubes, the mercury appears as a broad red stripe.

For temperatures above 750° F. or equivalent Boro Silicate glass is used.

# American Schaeffer & Budenberg Division

## American Submarine Thermometer

Straight Form

Angle Form

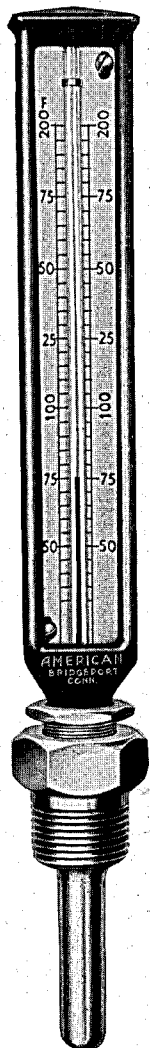

**T**HE American Submarine Thermometer is new in design and new in construction. It combines extreme lightness in weight with durability of construction, accuracy of operation and attractiveness in appearance.

The case is made of Phenol Condensate which has a compression strength of 25,000 lbs. per square inch, a tensile strength of 7,500 lbs. per square inch, a flexural strength of 10,000 lbs. per square inch, and an impact strength of 23 foot pounds.

This strength, combined with the lightness of material, results in a thermometer that will withstand severe shock and vibration conditions and still retain its accuracy.

The American Submarine Thermometer is particularly adaptable for marine use where weight and corrosion are factors.

Red reflecting mercury-filled tubes, properly annealed and seasoned, are used in this instrument.

The scale is silver finished with black or red numerals to increase visibility and assure easy reading. The scale opening is slightly over five inches and the scale length runs from  $4\frac{1}{2}$ " to  $4\frac{15}{16}$ " long. Temperature ranges are as desired up to 500° F.

The standard monel sockets are of the same dimensions as required in U. S. Navy specifications 18-T-14a.

Illustrations are  
2/3 Actual Size

Type 268  
Code word—LBFH

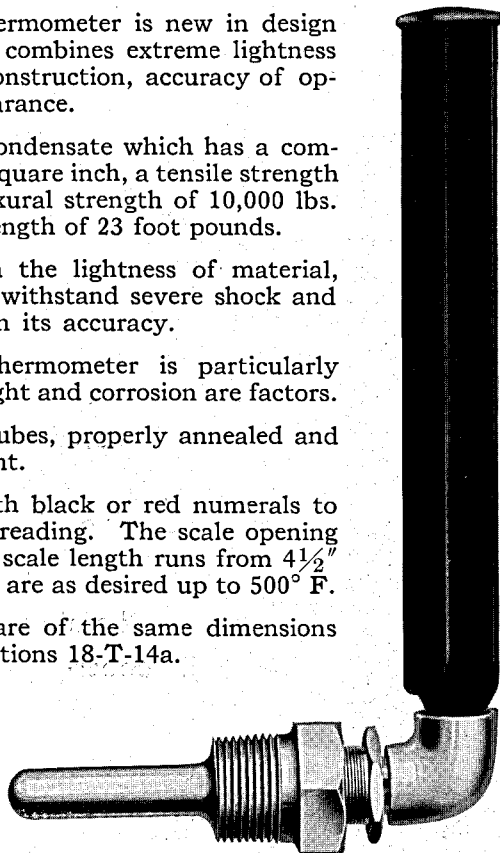

Type 269  
Code word—LBFI

### SPECIFICATIONS

American Submarine Thermometer in 5" Phenol Condensate case, with interchangeable monel socket  $3\frac{1}{4}$ " long overall, with  $\frac{3}{4}$ " N. P. T. connection; also furnished with brass sockets if desired.

Type No.	Form	LIST PRICES			NET WEIGHTS	
		With Monel Socket	With Brass Socket	Refills only, Without Socket	With Socket	Without Socket
268	Straight	\$ 8.75	\$ 7.25	\$ 6.00	12 oz.	6½ oz.
269	Angle	11.00	9.50	8.25	14½ oz.	9 oz.

The above prices are subject to discount.

Furnished with stems up to 15 inches long on special order. Prices on request.

American Flat Case, "V" Scale Thermometer  
Nickel-plated Iron Case

Ranges up to 600° F.

Straight Form Type

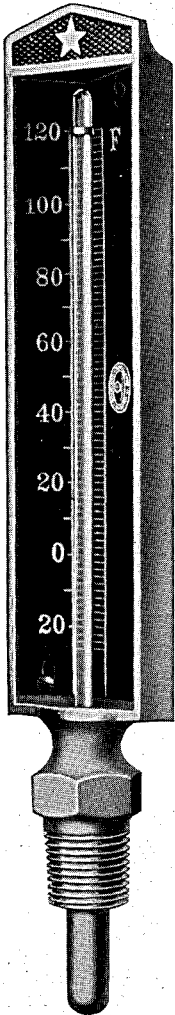

Type 274  
Code word—LBGD

A NEAT, serviceable Thermometer for general industrial uses. Furnished in nickel-plated, straight, iron case with one-piece "V" shaped scale, without glass front, 6" scale graduated for any temperature range not exceeding 600° F. or equivalent in C. or R. Any stem length up to 12". Scale is black oxidized with white figures.

Bulb Chamber and stem extensions are of steel, copper-plated.

Furnished with 1/2" Standard Pipe Thread Fixed Connection only.

Angle Form Type

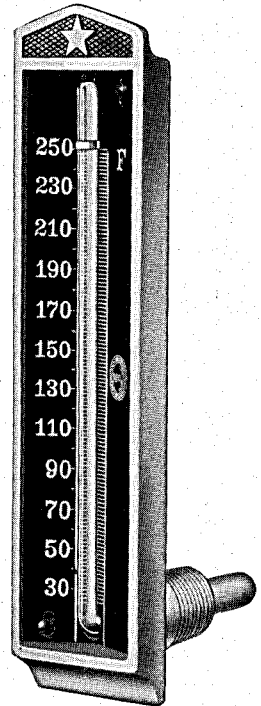

Type 276  
Code word—LBGF

LIST PRICES

For Temperature Ranges Up to 600° F.  
or Corresponding Degrees C.

Stem Length Including Thread	Type 274 Straight Stem	Type 276 Angle Stem
2 inch (Std.)	\$5.00	\$7.00
6 inch	6.00	8.00
9 inch	7.00	9.00
12 inch	8.00	10.00

Standard Stem is 2" long including thread.

All prices are subject to discount.

## American House Heater Thermometers

Carried in Stock at All Branches

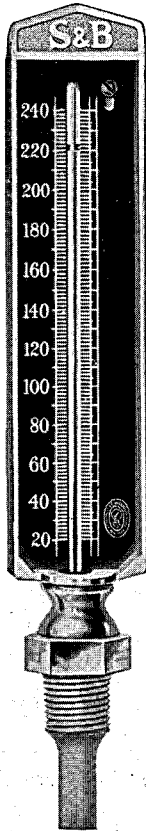

Type 278  
Code word—  
LBGH

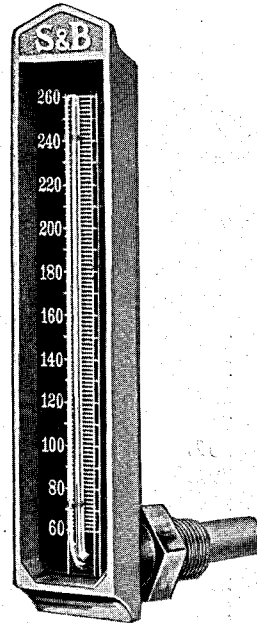

Type 280  
Code word—  
LBHJ

**T**HESE are our well known Hot Water Thermometers of which we sell thousands every year. Case is of cast iron, with black japanned finish, presenting an attractive appearance. The scales are white with black figures. The special magnifying mercury tube enables convenient reading.

Furnished with either mercury or red spirit columns. Socket is dull nickel finish.

Scale is 6 inches and graduated approximately 40-240° F. Variations are unavoidable and scales may start as low as 20° F. and go up as high as 270° F. Length of stem is 2" including thread. Connection is 1/2" Standard Pipe Thread. Accuracy guaranteed to within 1% of total scale.

### LIST PRICES

Type 278	Straight Form	.....	\$1.75 each
Type 280	Angle Form	.....	2.00 each

Above prices apply only for small quantities. Very attractive prices in quantity lots.

All prices are subject to discount.

## American Stem Etched Test Thermometers

Extra Quality

Nitrogen Filled

In Wood Cases

**F**OR general test and laboratory work Type 292 Test Thermometer will give excellent satisfaction. Carefully made of thoroughly seasoned Thermometer Glass, hand calibrated and deeply etched figures and graduating lines. Each Type 292 Thermometer is furnished in round wood case.

### LIST PRICES

No.	Length	Approximate Scale Range	Sub-division	Price Each
292A	12"	-20 plus 120° F.	1°	\$3.00
292B	12"	0 — 150° F.	1°	2.75
292C	12"	0 — 220° F.	2°	3.00
292D	12"	30 — 300° F.	2°	3.00
292E	14"	30 — 400° F.	2°	3.50
292F	16"	30 — 600° F.	2°	4.00
292G	16"	30 — 750° F.	2°	4.50
292H	16"	100 — 950° F.	5°	9.25
292I	12"	-10 plus 100° C.	1°	3.00
292J	12"	0 — 150° C.	1°	3.00
292K	14"	0 — 200° C.	1°	3.25
292L	16"	0 — 300° C.	1°	4.00
292M	16"	0 — 400° C.	1°	4.50
292N	16"	50 — 510° C.	2°	9.25

Maximum number of graduating subdivisions is 275 for 12" length, 350 for 14" length and 400 for 16" length.

These Test Thermometers are always calibrated for total immersion up to the reading point.

## Special Test Thermometers

We make any special size of Engraved Glass Stem Thermometers to order and shall be pleased to quote prices on receipt of the following information: Range of Temperature; How Graduated; Total Length; How many wanted; Immersion.

## Armored Thermometer

### Type 293

Where protection is desired for Test Thermometers, Type 293 armor can be furnished. Supplied in brass nickel-plated for all 12" Thermometers, and steel nickel-plated for longer lengths. Price of Type 293 is added to price of Type 292; 12" \$2.25; 14" \$2.50; 16" \$2.65.

No wood case furnished.

*A Test Certificate, similar to the sample reproduced on page 243, will be issued with any of the above thermometers when requested, at no extra charge.*

Type 292  
Code word—  
LBIB

Type 293  
Code word—  
LBIC

*certified test certificates  
will be furnished  
if desired*

## Pocket Test Thermometers

The Type 29 (right) is a Pocket Test Thermometer, hand calibrated and engraved, furnished in a chromium plated brass case with a pocket clip. The total length of the case is 6 1/4" and the thermometer tube is 5". The standard graduations are -20 to 120° F., 20 to 220° F. and -10 to 110° C., in two degree subdivisions. Other ranges to order. *(Red Reading Mercury)*

### LIST PRICE

Type 29, each..... \$3.50  
Extra glass tubes only, each..... 2.25

## Testing Thermometers

Type 247 Thermometer (left) is made especially for asphalt testing, meat testing or any other service where a pointed bulb is required. It is encased in a steel chromium plated armor with the bulb completely enclosed. The thermometer tube is hand calibrated and engraved for any range required not exceeding 650° F. The thermometer tube is 10" long and the total length of the case is 11".

### LIST PRICE

Type 247, Testing Thermometer..... \$8.75  
Refill only..... 4.50

## Type Metal Testing Thermometer

Type 294 Type Metal Test Thermometer is similar to the Type 247 Test Thermometer, except that the stem has a cast iron protection, the remainder of the armor being steel nickel plated. The thermometer tube is hand calibrated and engraved from 500 to 1000° F. and the length of the scale is 8". The length of the cast iron stem is 7" and the total length of the case is 18 3/8".

### LIST PRICE

Type 294, Type Metal Test Thermometer..... \$13.00

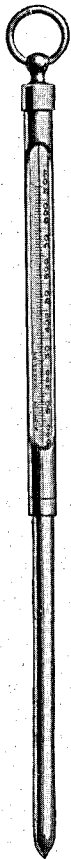

Type 247  
Code word—LBDG

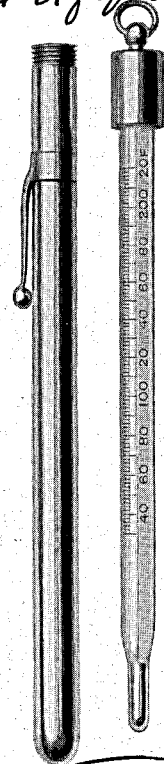

Type 29  
Code word—LBI

## Steel Mercury Wells

### For Use with Glass Stem Test Thermometers

These mercury wells are made according to the A. S. M. E. Power Test Code, and are machined from one piece of solid steel with a thin wall to effect quick transmission of heat. The bore is 3/8".

Type 26 has a plain stem and is suitable for use in liquids and saturated vapors. Type 28 is machined with fins for increasing the transmission of heat and is suitable for gases and superheated vapors.

Type 26 Plain Well	For Pipe Size, Inches	Size of Thread (Standard Pipe Thread)	Total Length of Well	Type 28 Finned Well
\$3.00	4-7"	1/2"	4 "	\$ 4.00
5.00	8" and over	3/4"	7 "	8.00

### Mercury Wells for High Pressure, High Temperature Power Plant Service

#### EXTRA HEAVY, SOLID BORED COLD ROLLED STEEL

Type 26 Plain Well	For Pipe Size, Inches	Size of Thread	Length Below Thread	Type 28 Finned Well
\$ 9.00	7-12"	3/4"	4 7/8"	\$10.00
11.00	13-20"	1"	8 1/16"	12.00

#### SOLID BORED STAINLESS STEEL

\$15.00	7-12"	3/4"	4 7/8"	\$17.00
18.00	13-20"	1"	8 1/16"	20.00

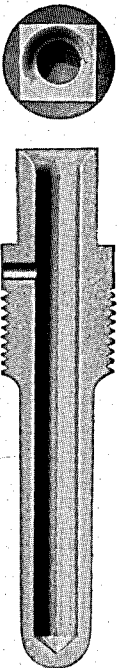

Type 26  
Code word—LBF

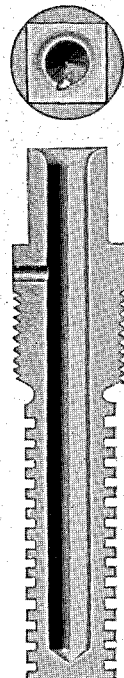

Type 28  
Code word—LBH



## American Wall Thermometer

**F**OR use in Homes, Hotels, Hospitals, Factories, Schools, etc. Also used for outside mounting.

Furnished in black art metal finished iron case, open front, with lugs at top and bottom for mounting. Scale is "V" shaped, 9" long, finished in silver with black figures and graduated from - 30 to + 120° F. (other ranges to order). Mercury filled red reflecting tubing is used. Accurate and reliable.

### LIST PRICE

Each.....\$4.25

## American Shiphold Thermometer

**D**ESIGNED and commonly used for determining hold temperatures on refrigerated ships. Also widely used for determining temperature in Brine Tanks and for other applications where it is desirable to lower a Thermometer into any hole or location difficult of access.

Fitted in black cast iron case with rubber bumper at bottom and rubber rings above and below scale as shown by illustration to protect against breakage when in use. A

ring is provided on top of the case for attaching cord or chain when using the Thermometer.

The diameter of Type 296 Shiphold Thermometer is 1 1/4", and 1 3/4" diameter across rubber bumper. Length of scale is 12". Scale is finished in dull black, with prominent white figures and graduated from - 20 to + 120° F. (other ranges to order). Mercury or red liquid filled Thermometer Tubes can be supplied. Red liquid Thermometers in stock.

List Price.....Each \$3.50

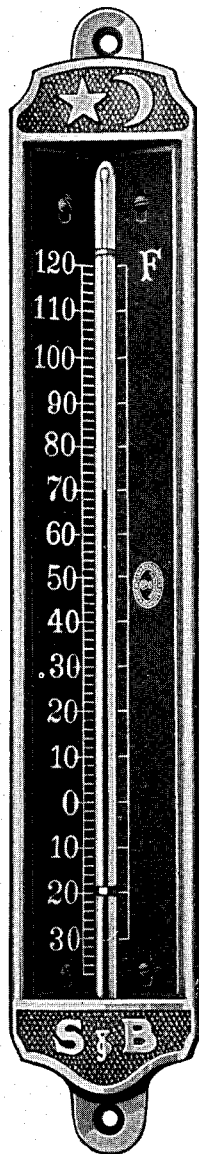

Type 295  
Code word—LBIE

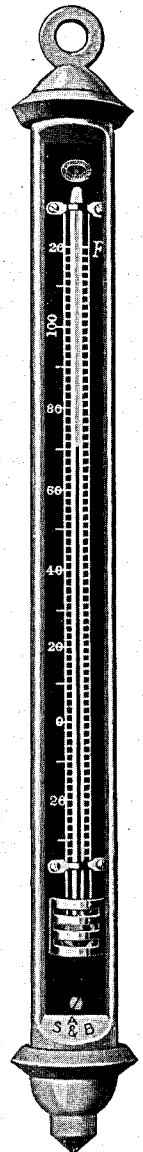

Type 296  
Code word—LBIF

## American Midget Thermometers Brass Case, Nickel-plated, Flat Scale

Ranges up to 600° F.

Straight  
Form

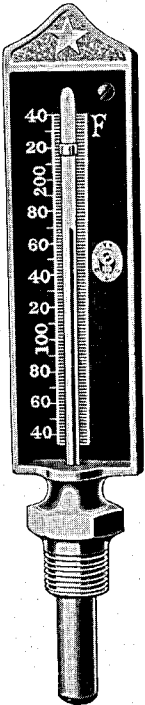

Type 282  
Code word—  
LBHB

Regular  
Angle Form

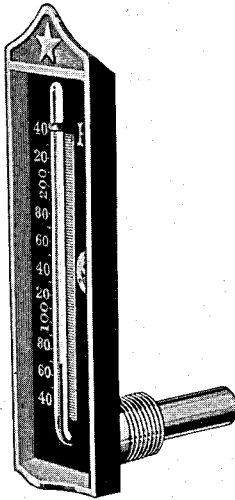

Type 283  
Code word—LBHC

Side Angle  
Form

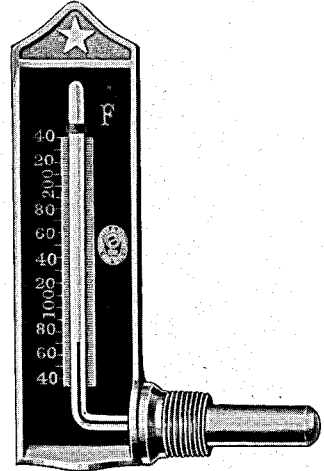

Type 284  
Code word—LBHD

**T**YPES 282, 283 and 284 Midget Thermometers serve where requirements call for a diminutive instrument. Applicable for installation to any small apparatus such as Instantaneous Water Heaters, Sterilizers, Radiators, etc., where a large Thermometer would be inappropriate.

Furnished in polished or nickel-plated brass case. Scale is 4 inches long and black oxidized with white figures. Scale case overall is  $4\frac{5}{8}$ ". Length from under side of hexagon on Straight Stem Type to Top of scale case is  $5\frac{1}{4}$ ". Stem  $1\frac{3}{4}$ " including thread. Furnished with scale ranges up to 600° F. Made in three patterns, Type 282 Straight Form, Type 283 Angle Form and Type 284 Left or Right Side Angle Form. (Type 284 shows Right Side Angle Form.) Connection is  $\frac{3}{8}$ " Standard Pipe Thread.

### LIST PRICES

Type 282.....	Each	\$4.25
Type 283.....	Each	5.50
Type 284.....	Each	6.00

*Special prices for quantities.*

When ordering Side Angle Forms, Specify whether Left or Right Side Angle is wanted.

# Consolidated Ashcroft Hancock Co., Inc.

## American Small Cylindrical Thermometers

Ranges up to 750° F.

Small Pattern

For Use on Shower Bath Mixing Chambers, Pasteurizers, Ice Cream Freezers, etc.

Straight Form

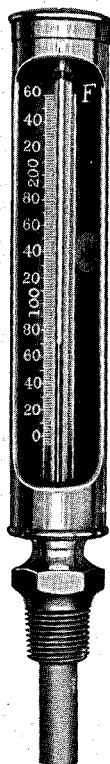

Type 288  
Code word—LBHH

Angle Form

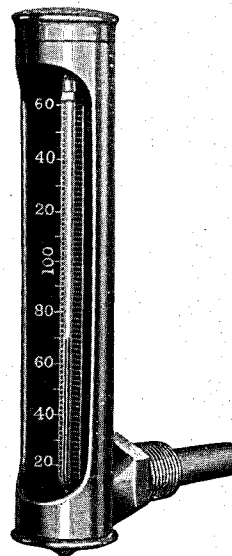

Type 289  
Code word—LBHI

### Standard Ranges

—20 to 120° F.

30 to 160° F.

30 to 240° F.

Other ranges to order.

**A** SMALL, highly finished Thermometer, sensitive and accurate. Furnished in nickel-plated cylindrical brass case without glass front as standard and in polished brass to special order. Scale is black oxidized with white figures graduated for any range, as desired up to 750° F. Length of scale 4½". Total length of scale case 5¼". Connection ⅜" or ½" standard pipe thread.

### LIST PRICES

Stem Length Including Thread	Standard Conn.	Type 288 Straight Stem	Type 289 Angle Stem
1¾"	⅜" or ½"	\$ 5.00	\$ 6.00
3 "	½"	7.00	8.00
6 "	½"	9.00	10.00
9 "	½"	10.50	11.50
12 "	½"	11.50	12.50

## For Your Convenience in Ordering American Thermometers

Please send the following information:

### MERCURY-IN-GLASS THERMOMETERS

1. Type No.
2. Size of Scale. If required inclined or reclined, state degree of incline or recline (see diagram on page 226).
3. Range (C, F or R).
4. Style of Connection: Fixed, Union, Separable Socket, Wall Fitting (if latter is required, state thickness of wall).
5. Size of thread on connection.
6. Length of stem including thread. If with wall fitting, state length of stem inside wall. If oblique stem, state degree of oblique (see diagram on page 226).
7. If stem will be exposed to corrosive action, state what metals best resist it.
8. What is Thermometer to be used for?

**Guarantee:** Every American Thermometer is guaranteed to be accurate within one per cent of the scale range, and for perfection of workmanship and material. Any thermometer which proves defective within one year from date of shipment may be returned for free repair or replacement, f. o. b. our factory, Bridgeport, Conn. We are not, however, responsible in any way for incidental damage or expense.

**Test Certificate:** When requested, a test certificate similar to the sample reproduced here, will be issued with any American Glass Front Thermometer or Test Thermometer at no extra charge.

**TEST CERTIFICATE**

This certifies that the American Thermometer described, with scale range 200-750°F has been tested by comparison with a U. S. Bureau of Standards Certified Thermometer, by approved methods, and the following corrections determined on this date 3-15-28

OBSERVED READINGS		
Standard Test Thermometer	This Thermometer Serial No.	Corrections to be applied to this Thermometer
212°	211.7	plus .3
500	498.9	" 1.1
725	725.6	minus .5

Readings by J. D. \_\_\_\_\_

Makers of American Industrial Instruments for 77 years

## American Dial Thermometers

Accuracy Guaranteed

### Easy To Read

For services where light conditions or others make it difficult to read a glass thermometer, American Dial Thermometers are recommended.

Dial sizes range from 4½" to 12" in diameter. Tube lengths up to 200 feet.

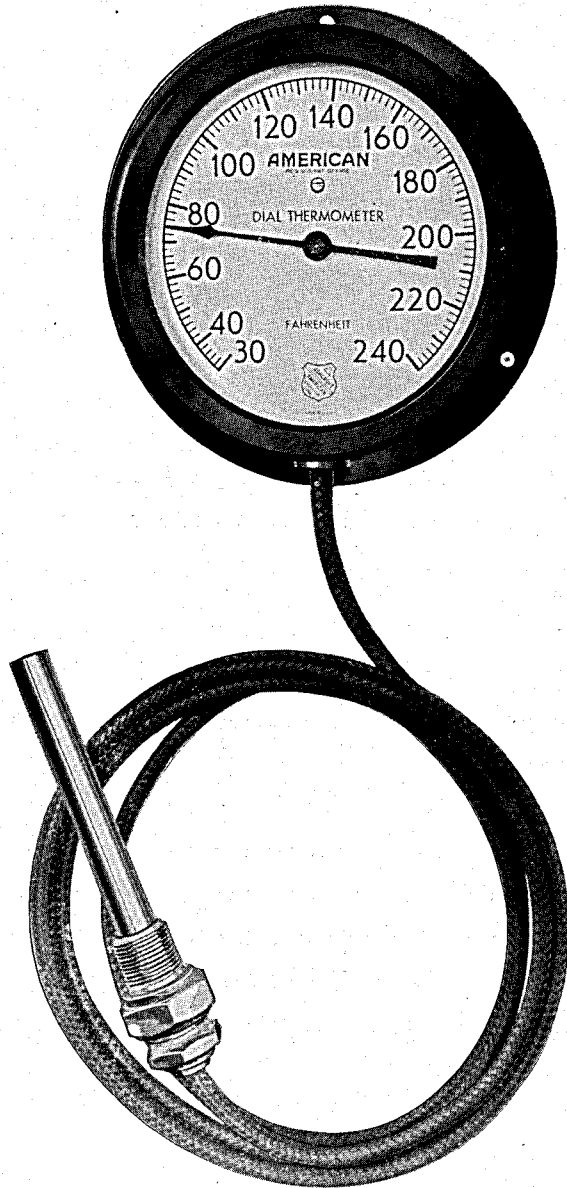

### Hard To Break

For services where operating conditions produce constant breakage of glass thermometers, American Dial Thermometers will pay for themselves in a surprisingly short time through the elimination of repair costs. Made for either distant reading with connecting tubing or for direct mounting with rigid connection.

For temperatures from minus 40 to plus 1000° F.

Ask for Catalog 600.

# American Schaeffer & Budenberg Division

## Temperature Conversion Table

By Albert Sauveur

(Reprinted through courtesy of Chemical and Metallurgical Eng.)

NOTE:—The numbers in bold face type refer to the temperature either in degrees Centigrade or Fahrenheit which it is desired to convert into the other scale. If converting from Fahrenheit degrees to Centigrade degrees the equivalent temperature will be found in the left column, while if converting from degrees Centigrade to degrees Fahrenheit, the answers will be found in the column on the right. These tables are a revision of those by Sauveur & Boylston, metallurgical engineers, Cambridge, Mass. Copyright, 1920.

### INTERPOLATION FACTORS

C.	F.	C.	F.
0.56	1	1.8	3.33
1.11	2	3.6	3.89
1.67	3	5.4	4.44
2.22	4	7.2	5.00
2.78	5	9.0	5.56
			6
			7
			8
			9
			10
			10.8
			12.6
			14.4
			16.2
			18.0

-50 to +100					+100 to +1000				
C.	F.	C.	F.	C.	F.	C.	F.	C.	F.
-45.6	50	-58	10.0	50	122.0	38	100	212	260
-40.0	-40	-40	10.6	51	123.8	43	110	230	266
-34.4	-30	-22	11.1	52	125.6	49	120	248	271
-28.9	-20	-4	11.7	53	127.4	54	130	266	277
-23.3	-10	14	12.2	54	129.2	60	140	284	282
-17.8	0	32	12.8	55	131.0	66	150	302	288
-17.2	1	33.8	13.3	56	132.8	71	160	320	293
-16.7	2	35.6	13.9	57	134.6	77	170	338	299
-16.1	3	37.4	14.4	58	136.4	82	180	356	304
-15.6	4	39.2	15.0	59	138.2	88	190	374	310
-15.0	5	41.0	15.6	60	140.0	93	200	392	316
-14.4	6	42.8	16.1	61	141.8	99	210	410	321
-13.9	7	44.6	16.7	62	143.6	100	212	413	327
-13.3	8	46.4	17.2	63	145.4	104	220	428	332
-12.8	9	48.2	17.8	64	147.2	110	230	446	338
-12.2	10	50.0	18.3	65	149.0	116	240	464	343
-11.7	11	51.8	18.9	66	150.8	121	250	482	349
-11.1	12	53.6	19.4	67	152.6	127	260	500	354
-10.6	13	55.4	20.0	68	154.4	132	270	518	360
-10.0	14	57.2	20.6	69	156.2	138	280	536	366
-9.44	15	59.0	21.1	70	158.0	143	290	554	371
-8.89	16	60.8	21.7	71	159.8	149	300	572	377
-8.33	17	62.6	22.2	72	161.6	154	310	590	382
-7.78	18	64.4	22.8	73	163.4	160	320	608	388
-7.22	19	66.2	23.3	74	165.2	166	330	626	393
-6.67	20	68.0	23.9	75	167.0	171	340	644	399
-6.11	21	69.8	24.4	76	168.8	177	350	662	404
-5.56	22	71.6	25.0	77	170.6	182	360	680	410
-5.00	23	73.4	25.6	78	172.4	188	370	698	416
-4.44	24	75.2	26.1	79	174.2	193	380	716	421
-3.89	25	77.0	26.7	80	176.0	199	390	734	427
-3.33	26	78.8	27.2	81	177.8	204	400	752	432
-2.78	27	80.6	27.8	82	179.6	210	410	770	438
-2.22	28	82.4	28.3	83	181.4	216	420	788	443
-1.67	29	84.2	28.9	84	183.2	221	430	806	449
-1.11	30	86.0	29.4	85	185.0	227	440	824	454
-0.56	31	87.8	30.0	86	186.8	232	450	842	460
0	32	89.6	30.6	87	188.6	238	460	860	466
0.56	33	91.4	31.1	88	190.4	243	470	878	471
1.11	34	93.2	31.7	89	192.2	249	480	896	477
1.67	35	95.0	32.2	90	194.0	254	490	914	482
2.22	36	96.8	32.8	91	195.8				488
2.78	37	98.6	33.3	92	197.6				493
3.33	38	100.4	33.9	93	199.4				499
3.89	39	102.2	34.4	94	201.2				504
4.44	40	104.0	35.0	95	203.0				510
5.00	41	105.8	35.6	96	204.8				516
5.56	42	107.6	36.1	97	206.6				521
6.11	43	109.4	36.7	98	208.4				527
6.67	44	111.2	37.2	99	210.2				532
7.22	45	113.0	37.8	100	212.0				538
7.78	46	114.8							1000
8.33	47	116.6							1832
8.89	48	118.4							
9.44	49	120.2							



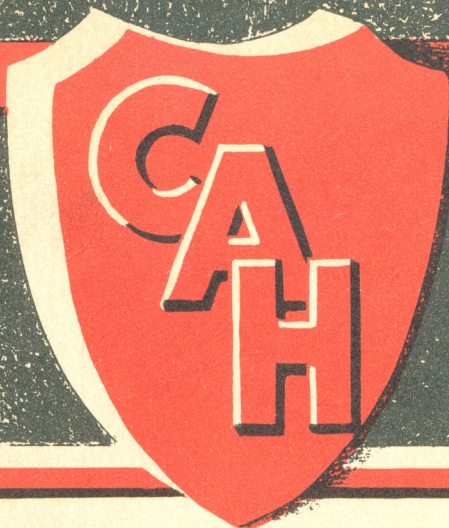

*Specify Catalogs desired*

**ASHCROFT AMERICAN GAUGE DIVISION**

- Catalog 1000 . . . . . Ashcroft American Indicating and Recording Gauges
- Catalog 1000-D . . . . . Drawn Case Gauges
- Catalog 1079 . . . . . Duragauges
- Catalog 1155 . . . . . Refinery Gauges

**AMERICAN SCHAEFFER & BUDENBERG DIVISION**

- Catalog 195 . . . . . American Hydraulagraphs
- Catalog 200 . . . . . American Thermometers
- Catalog 500 . . . . . American Tachometers
- Catalog 600 . . . . . American Dial Thermometers
- Catalog 1300 . . . . . American Gauge Testers
- Catalog 1350 . . . . . American Draft Gauges
- Catalog 2200 . . . . . American Precision Controllers
- Catalog 2510 . . . . . American Controlograph
- Catalog 3100 . . . . . American Recording Gauges
- Catalog 3300 . . . . . American Recording Thermometers
- Catalog 3320 . . . . . American Dairy Instruments
- Catalog 3330 . . . . . American Brewery Instruments
- Catalog 6100 . . . . . American Dial Thermometers
- Catalog 6500 . . . . . American Airplane Instruments

**CONSOLIDATED SAFETY VALVE DIVISION**

- Catalog 1400 . . . . . Consolidated Safety Valves
- Catalog 1525 . . . . . Ashcroft Power Control Valves

**HANCOCK VALVE DIVISION**

- Catalog 4000 . . . . . Hancock Bronze Valves
- Catalog 5000 . . . . . Hancock Cast Steel Valves
- Catalog 7000 . . . . . Hancock Forged Steel Valves
- Catalog 8000 . . . . . Hancock Stop and Check Valves, Stop-Checks and Blow-Off Valves
- Catalog 9000 . . . . . Hancock Gate Valves

**HANCOCK AND METROPOLITAN INJECTOR DIVISION**

- Catalog 100 . . . . . Hancock Inspirators, Metropolitan and H & D Injectors and Ejectors